

RFB NO. 316014



CONSTRUCTION DOCUMENTS PROJECT MANUAL

DANE COUNTY DEPARTMENT OF PUBLIC WORKS,
HIGHWAY AND TRANSPORTATION

PUBLIC WORKS ENGINEERING DIVISION
1919 ALLIANT ENERGY CENTER WAY
MADISON, WISCONSIN 53713

REQUEST FOR BIDS NO. 316014 COUNTY HIGHWAY FACILITY SATELLITE BUILDING U.S. HWY 151/COUNTY HWY. V TOWN OF YORK, DANE COUNTY, WISCONSIN

Due Date / Time: **TUESDAY, June 28, 2016 / 2:00 P.M.**

Location: **PUBLIC WORKS OFFICE**

Performance / Payment Bond: **100% OF CONTRACT AMOUNT**

Bid Deposit: **5% OF BID AMOUNT**

FOR INFORMATION ON THIS REQUEST FOR BIDS, PLEASE CONTACT:

RYAN SHORE, PROJECT MANAGER
TELEPHONE NO.: 608/266-4475
FAX NO.: 608/267-1533
E-MAIL: SHORE@COUNTYOFDANE.COM

TABLE OF CONTENTS FOR RFB NO. 316014

DIVISION 00 - PROCUREMENT AND CONTRACTING REQUIREMENTS

- Project Manual Cover Page
- Table of Contents
- Advertisement for Bids (Legal Notice)
- Best Value Contracting Application
- Instructions to Bidders
- Bid Form
- Fair Labor Practices Certification
- Sample Public Works Contract
- Sample Bid Bond
- Sample Performance Bond
- Sample Payment Bond
- Equal Benefits Compliance Payment Certification Form
- General Conditions of Contract
- Supplementary Conditions

DIVISION 01 - GENERAL REQUIREMENTS

- 01 00 00 - Basic Requirements
- 01 74 19 - Construction Waste Management, Disposal & Recycling

DIVISION 03 - CONCRETE

- 03 30 00 – Cast-In-Place Concrete

DIVISION 04 - MASONRY

- 04 20 00 – Unit Masonry

DIVISION 05 - METALS

- 05 50 00 – Metal Fabrications

DIVISION 06 - WOOD, PLASTICS AND COMPOSITES

- 06 10 00 – Rough Carpentry

DIVISION 07 - THERMAL AND MOISTURE PROTECTION

- 07 21 00 – Insulation
- 07 60 00 – Flashing and Sheet Metal
- 07 92 13 – Sealants and Caulking

DIVISION 08 - OPENINGS

- 08 11 00 – Metal Doors and Frames
- 08 30 00 – Special Doors
- 08 41 13 – Aluminum Entrances and Storefronts
- 08 71 00 – Hardware
- 08 80 00 – Glazing

DIVISION 09 - FINISHES

- 09 91 00 - Paint

DIVISION 13 -SPECIAL CONSTRUCTION

- 13 34 19 – Metal Building Systems

DIVISION 22 - PLUMBING

- 22 05 00 – Common Work Results for Plumbing
- 22 05 14 – Plumbing Specialties
- 22 05 29 – Hangers and Supports for Piping & Equipment

22 13 00 – Facility Sanitary & Process Sewerage

DIVISION 23 - HEATING, VENTILATING AND AIR CONDITIONING (HVAC)

23 05 00 – Common Work Results for HVAC
23 05 13 – Common Motor Requirements for HVAC Equipment
23 05 29 – Hangers and Supports for Piping and Equipment
23 05 93 – Testing, Adjusting and Balancing for HVAC
23 09 14 – Electrical Instrumentation and Control Devices for HVAC
23 11 00 – Facility Fuel Piping
23 31 00 – HVAC Ducts and Castings
23 33 00 – Air Duct Accessories
23 34 00 – HVAC Fans
23 54 00 – Fuel Fired Heating Equipment

DIVISION 26 - ELECTRICAL

26 05 00 – Electrical Provisions
26 05 19 – Low-Voltage Electrical Power Conductors and Cables
26 05 26 – Grounding and Bonding for Electrical Systems
26 05 29 – Hangers and Supports for Electrical Systems
26 05 33.13 – Conduit for Electrical Systems
26 05 33.16 – Boxes for Electrical Systems
26 05 53 – Identification for Electrical Systems
26 05 83 – Wiring Connections
26 09 16 – Electric Controls and Relays
26 09 23 – Lighting Control Devices
26 21 16 – Low-Voltage Underground Electrical Service Entrance
26 24 16 – Panelboards
26 27 16 – Electrical Cabinets and Enclosures
26 27 26 – Wiring Devices
26 28 13 – Fuses
26 28 16.16 – Enclosed Switches
26 51 00 – Interior Lighting
26 56 00 – Exterior Lighting

DIVISION 28 - ELECTRONIC SAFETY AND SECURITY

28 31 00 – Fire Detection and Alarm

DIVISION 31 - EARTHWORK

31 20 00 - Earthwork

DIVISION 32 - EXTERIOR IMPROVEMENTS

32 90 00 - Landscaping

DRAWINGS

Plot drawings on 24" x 36" (ARCH D) paper for correct scale or size.

A101 – Site Plan
A201 – Floor Plan and Roof Plan
A202- Exterior Elevations
A301 – Building Sections
A401 – Wall Sections
A402 – Wall Sections
A601 – Room and Door Schedules
S901 – Foundation Plan and Details
S902 – Framing Plan and Details
P204 – Plumbing Plan and Schedules

M208 – Mechanical Plan and Schedules
E211 – Satellite Building Electrical Plans
E508 – Satellite Building Schedules, Details

LEGAL NOTICE

INVITATION TO BID

Dane County Public Works, Highway & Transportation Dept., 1919 Alliant Energy Center Way, Madison, WI 53713, will receive sealed Bids until:

2:00 P.M., TUESDAY, JUNE 28, 2016

REQUEST FOR BIDS NO. 316014

COUNTY HIGHWAY FACILITY SATELLITE BUILDING

U.S. HIGHWAY 151/COUNTY HWY V

TOWN OF YORK, DANE COUNTY, WISCONSIN

Dane County is inviting Bids for construction services for a new pre-engineered metal building approximately 40' by 120' in size, as outlined in the project drawings and construction documents. Only firms with capabilities, experience & expertise with similar projects should obtain this Request for Bids document & submit Bids.

Request for Bids document may be obtained after **2:00 p.m. on June 7, 2016** by downloading it from countyofdane.com/pwbids. Please call Ryan L. Shore, Project Manager, at 608/266-4475, or our office at 608/266-4018, for any questions or additional information.

All Bidders must be a registered vendor with Dane County & pay an annual registration fee & must be pre-qualified as a Best Value Contractor before award of Contract, Agreement. Complete Vendor Registration Form at danepurchasing.com/Account/Login? or obtain one by calling 608/266-4131. Complete Pre-qualification Application for Contractors at countyofdane.com/pwht/BVC_Application.aspx or obtain one by calling 608/266-4029.

A pre-bid site tour will be held Thursday, June 16, 2016 at 10:00 a.m. at the County Highway Facility Satellite Building site. Bidders are strongly encouraged to attend this tour.

PUBLISH: JUNE 7 & 14, 2016 - WISCONSIN STATE JOURNAL
JUNE 7 & 14, 2016 - THE DAILY REPORTER



DANE COUNTY DEPARTMENT of PUBLIC WORKS, HIGHWAY and TRANSPORTATION

County Executive
Joseph T. Parisi

1919 Alliant Energy Center Way ♦ Madison, Wisconsin 53713
Phone: (608) 266-4018 ♦ FAX: (608) 267-1533

Commissioner / Director
Gerald J. Mandli

BEST VALUE CONTRACTING APPLICATION

CONTRACTORS / LICENSURE APPLICANTS

The Dane County Department of Public Works requires all contractors to be pre-qualified as a best value contractor with the County prior to being awarded a contract. In addition, the County pre-qualifies potential contractors and sub-contractors who wish to work on County contracts. Subcontractors must become pre-qualified ten (10) days prior to commencing work under any Dane County Public Works Contract. Potential subcontractors are urged to become pre-qualified as early as possible. This document shall be completed, properly executed, along with the necessary attachments and additional information that the County requires for the protection and welfare of the public in the performance of a County contract.

Contractors or subcontractors of any tier who attain pre-qualification status will retain that status for a period of two (2) years from the date of qualification. Contractors shall notify the Dane County Department of Public Works, Highway & Transportation within fifteen (15) days of any changes to its business or operations that are relevant to the pre-qualification application. Failure to do so could result in suspension, revocation of the contractor's pre-qualification, debarment from County contracts for up to three (3) years and / or other sanctions available under the law.

No contracts will be awarded for construction work performed on Dane County projects unless the contractor is currently approved as a Wisconsin Trade Trainer or has applied for approval as an Apprenticeship Trade Trainer to the Wisconsin Department of Workforce Development and agrees to an acceptable apprenticeship program. If you are not currently approved as a Wisconsin Trade Trainer, or have not applied for approval as an Apprenticeship Trade Trainer, please contact the Department of Workforce Development - Bureau of Apprenticeship Standards at 608/266-3133 or visit their web site at: dwd.wisconsin.gov/apprenticeship/.

EXEMPTIONS

- Contractors who employ less than five (5) apprenticeable trade workers are not required to pre-qualify.
- Contractors performing work that does not apply to an apprenticeable trade, as outlined in Appendix A.
- The contractor / subcontractor provides sufficient documentation to demonstrate one or more of the following:
 - apprentices are not available in a specific geographic area;
 - the applicable apprenticeship program is unsuitable or unavailable; or
 - there is a documented depression of the local construction market which prevents compliance.

SEC.	PROOF OF RESPONSIBILITY	CHECK IF APPLICABLE
1	Does your firm possess all technical qualifications and resources, including equipment, personnel and financial resources, necessary to perform the work required for any project or obtain the same through the use of responsible, pre-qualified subcontractors?	Yes: <input type="checkbox"/> No: <input type="checkbox"/>
2	Will your firm possess all valid, effective licenses, registrations or certificates required by federal, state, county, or local law, which are necessary for the type of work to be performed including, but not limited to, those for any type of trade work or specialty work?	Yes: <input type="checkbox"/> No: <input type="checkbox"/>
3	Will your firm meet all bonding requirements as required by applicable law or contract specifications?	Yes: <input type="checkbox"/> No: <input type="checkbox"/>
4	Will your firm meet all insurance requirements as required by applicable law or specifications, including general liability insurance, workers compensation insurance and unemployment insurance requirements?	Yes: <input type="checkbox"/> No: <input type="checkbox"/>
5	Will your firm maintain a substance abuse policy for employees hired for public works contracts that comply with Wis. Stats. Sec. 103.503?	Yes: <input type="checkbox"/> No: <input type="checkbox"/>
6	Does your firm acknowledge that it must pay all craft employees on public works projects the wage rates and benefits required under Section 66.0903 of the Wisconsin Statutes?	Yes: <input type="checkbox"/> No: <input type="checkbox"/>
7	Will your firm fully abide by the equal opportunity and affirmative action requirements of all applicable laws, including County ordinances?	Yes: <input type="checkbox"/> No: <input type="checkbox"/>
8	In the past three (3) years, has your firm had control or has another corporation, partnership or other business entity operating in the construction industry controlled it? If so, please attach a statement explaining the nature of the firm relationship?	Yes: <input type="checkbox"/> No: <input type="checkbox"/> If Yes, attach details.
9	In the past three (3) years, has your firm had any type of business, contracting or trade license, certification or registration revoked or suspended?	Yes: <input type="checkbox"/> No: <input type="checkbox"/> If Yes, attach details.
10	In the past three (3) years, has your firm been debarred by any federal, state or local government agency?	Yes: <input type="checkbox"/> No: <input type="checkbox"/> If Yes, attach details.
11	In the past three (3) years, has your firm defaulted or failed to complete any contract?	Yes: <input type="checkbox"/> No: <input type="checkbox"/> If Yes, attach details.
12	In the past three (3) years, has your firm committed a willful violation of federal, state or local government safety laws as determined by a final decision of a court or government agency authority.	Yes: <input type="checkbox"/> No: <input type="checkbox"/> If Yes, attach details.
13	In the past three (3) years, has your firm been in violation of any law relating to your contracting business where the penalty for such violation resulted in the imposition of a penalty greater than \$10,000?	Yes: <input type="checkbox"/> No: <input type="checkbox"/> If Yes, attach details.
14	Is your firm Executive Order 108 precertified with the State of Wisconsin?	Yes: <input type="checkbox"/> No: <input type="checkbox"/>
15	Is your firm an active Wisconsin Trade Trainer as determined by the Wisconsin Bureau of Apprenticeship Standards?	Yes: <input type="checkbox"/> No: <input type="checkbox"/>
16	Is your firm exempt from being pre-qualified with Dane County?	Yes: <input type="checkbox"/> No: <input type="checkbox"/> If Yes, attach reason for exemption.
17	Does your firm acknowledge that in doing work under any County Public Works Contract, it will be required to use as subcontractors only those contractors that are also pre-qualified with the County or become so ten days prior to commencing work?	Yes: <input type="checkbox"/> No: <input type="checkbox"/>
18	Contractor has been in business less than one year?	Yes: <input type="checkbox"/> No: <input type="checkbox"/>
19	Is your firm a first time Contractor requesting a one time exemption, but, intend to comply on all future contracts and are taking steps typical of a "good faith" effort?	Yes: <input type="checkbox"/> No: <input type="checkbox"/>
20	Not applicable. My firm does not intend to work on Best Value Contracts. Note: Best Value Contracting is required to bid on most Public Works Contracts (if unclear, please call Jan Neitzel Knox 608-266-4029).	Yes: <input type="checkbox"/> No: <input type="checkbox"/>

SIGNATURE SECTION

Your firm's Officer, or the individual who would sign a bid and / or contract documents must sign this document.

I do hereby certify that all statements herein contained are true and correct to the best of my knowledge:

Signature

Date

Printed or Typed Name and Title

NAME AND ADDRESS OF CONTRACTOR	
Name of Firm:	
Address:	
City, State, Zip:	
Telephone Number:	
Fax Number:	
E-mail Address:	

REMEMBER!

Return all to forms and attachments, or questions to:

**JAN NEITZEL KNOX
EMAIL: NEITZEL-KNOX@COUNTYOFDANE.COM
OFFICE: (608)266-4029, FAX: (608)267-1533**

**DANE COUNTY DEPARTMENT OF PUBLIC WORKS,
HIGHWAY & TRANSPORTATION
1919 ALLIANT ENERGY CENTER WAY
MADISON, WI 53713**

APPENDIX A

APPRENTICEABLE TRADES

Bricklayer
Carpenter
Cement Mason (Concrete Finisher)
Cement Mason (Heavy Highway)
Construction Craft Laborer
Data Communications Installer
Electrician
Elevator Mechanic / Technician
Environmental Systems Technician / HVAC Service Technician / HVAC Install & Service
Glazier
Heavy Equipment Operator / Operating Engineer
Insulation Worker (Heat & Frost)
Iron Worker (Assembler, Metal Buildings)
Painter / Decorator
Plasterer
Plumber
Roofer / Waterproofer
Sheet Metal Worker
Sprinkler Fitter
Steamfitter (Service & Refrigeration)
Taper & Finisher
Telecommunications (Voice, Data & Video) Installer / Technician
Tile Setter

INSTRUCTIONS TO BIDDERS

TABLE OF CONTENTS

1. GENERAL.....	1
2. DRAWINGS AND SPECIFICATIONS	1
3. INTERPRETATION	2
4. QUALIFICATIONS OF BIDDER (CONTRACTOR AND SUBCONTRACTOR)....	2
5. BID GUARANTEE	3
6. WITHDRAWAL OF BIDS.....	3
7. CONTRACT FORM	3
8. CONTRACT INTERESTS BY COUNTY PUBLIC OFFICIALS	3
9. EMERGING SMALL BUSINESS PROVISIONS	3
10. METHOD OF AWARD - RESERVATIONS	5
11. SECURITY FOR PERFORMANCE AND PAYMENTS	6
12. TAXES.....	6
13. SUBMISSION OF BIDS	6
14. SUBCONTRACTOR LISTING.....	7
15. ALTERNATE BIDS	7
16. INFORMATIONAL BIDS	7
17. UNIT PRICES.....	7
18. COMMENCEMENT AND COMPLETION	8
19. WORK BY OWNER	8
20. SPECIAL HAZARDS COVERAGE	8
FORM A	9
FORM B.....	10
FORM C.....	11
FORM D	12

1. GENERAL

- A. Before submitting Bid, bidder shall thoroughly examine all Construction Documents. Successful Bidder shall be required to provide all the Work that is shown on Drawings, set forth in Specifications, or reasonably implied as necessary to complete Contract for this project.
- B. Bidder shall visit site to become acquainted with adjacent areas, means of approach to site, conditions of actual site and facilities for delivering, storing, placing, and handling of materials and equipment.
- C. Pre-bid meeting is scheduled on June 16, 2016 at 10:00 a.m. at the site of the County Highway Facility Satellite Building, U.S. Highway 151/County HWY V.. Attendance by all bidders is optional, however bidders and subcontractors are strongly encouraged to attend.
- D. Failure to visit site or failure to examine any and all Construction Documents will in no way relieve successful Bidder from necessity of furnishing any necessary materials or equipment, or performing any work, that may be required to complete the Work in accordance with Drawings and Specifications. Neglect of above requirements will not be accepted as reason for delay in the Work or additional compensation.

2. DRAWINGS AND SPECIFICATIONS

- A. Drawings and Specifications that form part of this Contract, as stated in Article 1 of General Conditions of Contract, are enumerated in Document Index of these Construction Documents.

- B. Complete sets of Drawings and Specifications for all trades will be available to all Bidders, irrespective of category of work to be bid on, in order that all Bidders may be familiar with work of other trades as they affect their bid.

3. INTERPRETATION

- A. No verbal explanation or instructions will be given in regard to meaning of Drawings or Specifications before Bid Due Date. Bidders shall bring inadequacies, omissions or conflicts to Owner or Architect / Engineer's attention at least ten (10) calendar days before Bid Due Date. Prompt clarification will be available to all bidders by Addendum.
- B. Failure to so request clarification or interpretation of Drawings and Specifications will not relieve successful Bidder of responsibility. Signing of Contract will be considered as implicitly denoting that Contractor has thorough understanding of scope of the Work and comprehension of Construction Documents.
- C. Owner or Architect / Engineer will not be responsible for verbal instructions.

4. QUALIFICATIONS OF BIDDER (CONTRACTOR AND SUBCONTRACTOR)

- A. Before award of Contract can be approved, Owner shall be satisfied that Bidder involved meets following requirements:
 - 1. Has completed at least one (1) project of at least fifty percent (50%) of size or value of Division of work being bid and type of work completed is similar to that being bid. If greater magnitude of experience is deemed necessary, other than size or value of work, such requirements will be described in appropriate section of Specifications.
 - 2. Maintains permanent place of business.
 - 3. Can be bonded for terms of proposed Contract.
 - 4. Has record of satisfactorily completing past projects. Criteria which will be considered in determining satisfactory completion of projects by bidder will include:
 - a. Completed contracts in accordance with drawings and specifications.
 - b. Diligently pursued execution of work and completed contracts according to established time schedule unless Owner grants extensions.
 - c. Fulfilled guarantee requirements of construction documents.
 - d. Is not presently on ineligible list maintained by County's Department of Administration for noncompliance with equal employment opportunities and affirmative action requirements.
 - e. Authorized to conduct business in Wisconsin. By submitting Bid, bidder warrants that it has: complied with all necessary requirements to do business in State of Wisconsin; that persons executing contract on its behalf are authorized to do so; and, if corporation, that name and address of bidder's registered agent are as set forth in Contract. Bidder shall notify Owner immediately, in writing, of any change in its registered agent, their address, and bidder's legal status. For partnership, term "registered agent" shall mean general partner.
- B. County's Public Works Project Engineer will make such investigations as are deemed necessary to determine ability of bidder to perform the Work, and bidder shall furnish to County's Public Works Project Engineer or designee all such information and data for this purpose as County's Public Works Project Engineer may request. Owner reserves right to reject Bid if evidence submitted by, or investigation of, bidder fails to satisfy Owner that

bidder is responsible and qualified to carry out obligations of Contract and to complete the Work contemplated therein.

5. BID GUARANTEE

- A. Bank certified check, cashier's check or Bid Bond, payable to County in amount not less than five percent (5%) of maximum bid, shall accompany each Bid as guarantee that if Bid is accepted, Bidder will execute and return proposed Contract and Performance and Payment Bonds within ten (10) business days after being notified of acceptance of Bid. Company issuing bonds must be licensed to do business in Wisconsin.
- B. Any bid, which is not accompanied by bid guarantee, will be considered "No Bid" and will not be read at Bid Due Date.
- C. If successful Bidder so delivers Contract, Certificate of Insurance, and Performance and Payment Bonds, check will be returned to Bidder. In case Bidder fails to deliver such Contract, insurance, and bond, amount of bid guarantee will be forfeited to County as liquidated damages.
- D. All checks tendered as bid guarantee, except those of three (3) lowest qualified, responsible bidders, will be returned to their makers within three (3) business days after Bid Due Date. All such retained checks will be returned immediately upon signing of Contract and Performance and Payment Bonds by successful Bidder.

6. WITHDRAWAL OF BIDS

- A. Bids may be withdrawn by written request received from bidder or authorized representative thereof prior to time fixed for Bid Due Date, without prejudice to right of bidder to file new Bid. Withdrawn Bids will be returned unopened. Negligence on part of bidder in preparing their Bid confers no right for withdrawal of Bid after it has been opened.
- B. No Bid may be withdrawn for period of sixty (60) calendar days after Bid Due Date.
- C. If Bid contains error, omission or mistake, bidder may limit liability to amount of bidder's guarantee by giving written Notice of Intent not to execute Contract to Owner within seventy-two (72) hours of Bid Due Date.

7. CONTRACT FORM

- A. Sample copy of contract that successful Bidder will be required to enter into is included in these Construction Documents and bidders are required to familiarize themselves with all conditions contained therein.

8. CONTRACT INTERESTS BY COUNTY PUBLIC OFFICIALS

- A. In accordance with Wisconsin Statute 946.13, county official may not bid for or enter into any contract involving receipts or disbursements of more than \$15,000.00 in a year, in which they have private pecuniary interest, direct or indirect if at same time they are authorized to take official action with respect to making of this Contract. Any contract entered into in violation of this Statute is void and County incurs no liability thereon. This subsection does not affect application and enforcement of Wisconsin Statute 946.13 by state prosecutors in criminal courts of this state.

9. EMERGING SMALL BUSINESS PROVISIONS

- A. **Emerging Small Business Definition.** For purposes of this provision, ESB is defined as:
1. Independent business concern that has been in business minimum of one year;
 2. Business located in State of Wisconsin;
 3. Business comprised of less than twenty-five (25) employees;
 4. Business must not have gross sales in excess of three million dollars (\$3,000,000.00) over past three years; and
 5. Business does not have history of failing to complete projects.
- B. **Emerging Small Business (ESB) Involvement.** Bidder shall make good faith effort to award minimum of ten percent (10%) of the Work to ESBs. Bidder shall submit report to Dane County Contract Compliance Officer within ten (10) business days of Bid Due Date demonstrating such efforts. Good faith efforts means significant contact with ESBs for purposes of soliciting bids from them. Failure to make or demonstrate good faith efforts will be grounds for disqualification.
- C. **Emerging Small Business Report.** Emerging Small Business Enterprise Report is to be submitted by Bidder in separate envelope marked "Emerging Small Business Report". This report is due by 2:00 p.m. following specified ten (10) business days after Bid Due Date. Bidder who fails to submit Emerging Small Business Report shall be deemed not responsive.
- D. **ESB Goal.** Goal of this project is ten percent (10%) ESB participation. ESB utilizations are shown as percentage of total Bid. If Bidder meets or exceeds specified goal, Bidder is only required to submit Form A - Certification, and Form B - Involvement. Goal shall be met if Bidder qualifies as ESB.
- E. **Report Contents.** Following award of Contract, Bidder shall submit copies of executed contracts for all Emerging Small Businesses. Emerging Small Business Report shall consist of these:
1. Form A - Certification;
 2. Form B - Involvement;
 3. Form C - Contacts;
 4. Form D - Certification Statement (if appropriate); and
 5. Supportive documentation (i.e., copies of correspondence, telephone logs, copies of advertisements).
- F. **ESB Listing.** Bidders may solicit bids from this ESB listing: pdf.countyofdane.com/commissions/2013-2015_Targeted_Business_Directory.pdf.
- G. **ESB Certification.** All contractors, subcontractors and suppliers seeking ESB certification must complete and submit Emerging Small Business Report to Dane County Contract Compliance Program.
- H. **Certification Statement.** If ESB firm has not been certified by County as ESB prior to submittal of this Bid, ESB Report cannot be used to fulfill ESB goal for this project unless firm provides "Form D - Certification Statement". Certification statement must be completed and signed by ESB firm.

I. **Questions.** Questions concerning Emerging Small Business provisions shall be directed to:

Dane County Contract Compliance Officer
City-County Building, Room 421
210 Martin Luther King, Jr. Blvd.
Madison, WI 53703
608/266-5623

J. **Substituting ESBs.** In event of any significant changes in subcontract arrangements or if need arises to substitute ESBs, Bidder shall report such proposed changes to Contract Compliance Officer to making any official changes and request authorization to substitute ESB firm. Bidder further agrees to make every possible effort to replace ESB firm with another qualified ESB firm.

K. **Good Faith Efforts.** Good faith efforts can be demonstrated by meeting all of these obligations:

1. Selecting portions of the Work to be performed by ESBs in order to increase likelihood of meeting ESB goal including, where appropriate, breaking down Contract into smaller units to facilitate ESB participation.
2. Advertising in general circulation, trade associations and women / minority focus media concerning subcontracting opportunities.
3. Providing written notices to reasonable number of specific ESBs that their interest in Contract was being solicited in sufficient time to allow ESBs to participate effectively.
4. Following up on initial solicitations of interest by contacting ESBs within five (5) business days prior to Bid Due Date to determine with certainty whether ESB were interested, to allow ESBs to prepare bids.
5. Providing interested ESB with adequate information about Drawings, Specifications and requirements of Contract.
6. Using services of available minority, women and small business organizations and other organizations that provide assistance in recruitment of MBEs / WBEs / ESBs.
7. Negotiating in good faith with interested ESBs, not rejecting ESBs as unqualified without sound reason based on thorough investigation of their capabilities.
8. Submitting required project reports and accompanying documents to County's Contract Compliance Officer within twenty-four (24) hours after Bid Due Date.

L. **Appeals Disqualification of Bid.** Bidder who is disqualified may appeal to Public Works & Transportation Committee and Equal Opportunity Commission.

10. METHOD OF AWARD - RESERVATIONS

- A. Following will be basis of award of Contract, providing cost does not exceed amount of funds then estimated by County as available to finance Contract(s):
1. Lowest dollar amount submitted by qualified responsible bidder on Base Bid for all work comprising project, combined with such additive Owner accepted alternates.

2. Owner reserves right to reject all bids or any bid, to waive any informality in any bid, and to accept any bid that will best serve interests of County.
3. Unit Prices and Informational Bids will not be considered in establishing low bidder.

11. SECURITY FOR PERFORMANCE AND PAYMENTS

- A. Simultaneous with delivery of signed Contract, Bidder shall be required to furnish Performance and Payment Bonds as specified in Article 29 of General Conditions of Contract, "Contract Security". Surety Company shall be licensed to do business in Wisconsin. Performance and Payment Bonds must be dated same date or subsequent to date of Contract. Performance and Payment Bonds must emulate information in Sample Performance and Payment Bonds in Construction Documents.
- B. Provide certified copy of power of attorney from Surety Company showing that agent who signs Bond has power of attorney to sign for Surety Company. Secretary or Assistant Secretary of company must sign this certification, not attorney-in-fact. Certification must bear same or later date as Bond. Power of Attorney must emulate model power of attorney information detailed in Sample Performance and Payment Bonds.
- C. If Bidder is partnership or joint venture, State certified list, providing names of individuals constituting partnership or joint venture must be furnished. Contract itself may be signed by one partner of partnership, or one partner of each firm comprising joint venture, but Performance and Payment Bonds must be signed by all partners.
- D. If Bidder is a corporation, it is necessary that current certified copy of resolution or other official act of directors of corporation be submitted showing that person who signs Contract is authorized to sign contracts for corporation. It is also necessary that corporate seal be affixed to resolution, contract, and performance and payment bonds. If your corporation has no seal, it is required that above documents include statement or notation to effect that corporation has no seal.

12. TAXES

- A. Wisconsin Statute 77.54 (9m) allows building materials that become part of local unit government facilities to be exempt from sales & use tax. Vendors & materials suppliers may not charge Bidders sales & use tax on these purchases. This does not include highways, streets or roads. Any other Sales, Consumer, Use & other similar taxes or fees required by law shall be included in Bid.
- B. In accordance with Wisconsin Statute 71.80(16)(a), successful nonresident bidder, whether incorporated or not, and not otherwise regularly engaged in business in this state, shall file surety bond with State of Wisconsin Department of Revenue payable to Department of Revenue, to guarantee payment of income taxes, required unemployment compensation contributions, sales and use taxes and income taxes withheld from wages of employees, together with any penalties and interest thereon. Amount of bond shall be three percent (3%) of Contract or subcontract price on all contracts of \$50,000 or more.

13. SUBMISSION OF BIDS

- A. All Bids shall be submitted on standard Bid Form bound herein and only Bids that are made on this Bid Form will be considered. Entire Bid Form and other supporting documents, if any, shall be removed or copied from Construction Documents, filled out, and submitted in manner specified hereinafter. Submit completed Bid Bond with Bid as well.

- B. No bids for any subdivision or any sub-classification of this Work, except as indicated, will be accepted. Any conditional Bid, amendment to Bid Form or appended item thereto, or inclusion of any correspondence, written or printed matter, or details of any nature other than that specifically called for, which would alter any essential provision of Construction Documents, or require consideration of unsolicited material or data in determining award of Contract, will disqualify Bid. Telecommunication alterations to Bid will not be accepted.
- C. Bidders must submit single Bid for all the Work.
- D. Bid amounts shall be inserted in words and in figures in spaces provided on Bid Form; in case of conflict, written word amounts will govern.
- E. Addenda issued after Bid Letting shall become part of Construction Documents. Bidders shall acknowledge receipt of such addenda in appropriate space provided on Bid Form. Bid may be rejected if receipt of any particular addendum applicable to award of Contract has not been acknowledged on Bid Form.
- F. Bids shall be signed, placed in envelope, sealed and delivered before due time to place designated in Invitation to Bid, and identified with project name, bid number, location, category of work being bid upon, Bid Due Date, name and address of bidder.
- G. Bidder shall be responsible for sealed Bid being delivered to place designated for Bid Due Date on or before date and time specified. Bids received after time of closing will be rejected and returned to bidder unopened.
- H. Bid will be considered invalid and will be rejected if bidder has not signed it.
- I. Faxed or emailed Bids will not be accepted.
- J. Bidder's organization shall submit completed with Bid, Fair Labor Practices Certification form, included in these Construction Documents.

14. SUBCONTRACTOR LISTING

- A. Bidders shall be required to submit list of major subcontractors for General Construction, Plumbing, HVAC, and Electrical work proposed for this project to include committed prices for each subcontractor. List shall be placed in separate sealed envelope that must be clearly identified as "Major Subcontractor List", for named project and name of Bidder submitting it. County must receive envelope no later than date by which successful Bidder is required to submit his or her signed Contract, as established in Construction Documents.

15. ALTERNATE BIDS

- A. Not Applicable.

16. INFORMATIONAL BIDS

- A. Not Applicable.

17. UNIT PRICES

- A. Not Applicable.

18. COMMENCEMENT AND COMPLETION

- A. Successful Bidder shall commence work when schedule and weather permit, but no later than stated in Bid Form. Contractor shall pursue the Work regularly and continuously at reasonable rate to insure completion of the Work within time stated in Bid.
- B. Should it be found impossible to complete the Work on or before time specified for completion, written request may be submitted for extension of time setting forth reasons believed to justify granting of such request. Refer to Article 20 of General Conditions of Contract, titled "Time for Completion".

19. WORK BY OWNER

- A. Not Applicable.

20. SPECIAL HAZARDS COVERAGE

- A. Not Applicable.

FORM A

**DANE COUNTY
EMERGING SMALL BUSINESS REPORT - CERTIFICATION**

In accordance with General Conditions of Contract, submit this Emerging Small Business Report within ten (10) days after Bid Due Date.

PROJECT NAME: _____

BID NO.: _____ BID DUE DATE: _____

BIDDER INFORMATION

COMPANY NAME: _____

ADDRESS: _____

TELEPHONE NO.: _____

CONTACT PERSON: _____

EMAIL ADDRESS: _____

FORM B

Page ___ of ___

DANE COUNTY

(Copy this Form as necessary to provide complete information)

EMERGING SMALL BUSINESS REPORT - INVOLVEMENT

COMPANY NAME: _____

PROJECT NAME: _____

BID NO.: _____ BID DUE DATE: _____

ESB NAME: _____

CONTACT PERSON: _____

ADDRESS: _____

PHONE NO & EMAIL.: _____

Indicate percentage of financial commitment to this ESB: _____ % Amount: \$ _____

ESB NAME: _____

CONTACT PERSON: _____

ADDRESS: _____

PHONE NO & EMAIL.: _____

Indicate percentage of financial commitment to this ESB: _____ % Amount: \$ _____

FORM C

Page ___ of ___

**DANE COUNTY
EMERGING SMALL BUSINESS REPORT - CONTACTS**

(Copy this Form as necessary to provide complete information)

COMPANY NAME: _____

PROJECT NAME: _____

BID NO.: _____ BID DUE DATE: _____

	<u>ESB FIRM NAME CONTACTED</u>	<u>DATE</u>	<u>PERSON CONTACTED</u>	<u>DID ESB BID?</u>	<u>ACC- EPT BID?</u>	<u>REASON FOR REJECTION</u>
1)	_____	_____	_____	_____	_____	_____
2)	_____	_____	_____	_____	_____	_____
3)	_____	_____	_____	_____	_____	_____
4)	_____	_____	_____	_____	_____	_____
5)	_____	_____	_____	_____	_____	_____
6)	_____	_____	_____	_____	_____	_____
7)	_____	_____	_____	_____	_____	_____
8)	_____	_____	_____	_____	_____	_____

FORM D

**DANE COUNTY
EMERGING SMALL BUSINESS REPORT - CERTIFICATION STATEMENT**

I, _____, _____ of
Name Title

_____ certify to best of my knowledge and
Company

belief that this business meets Emerging Small Business definition as indicated in Article 9 and
that information contained in this Emerging Small Business Report is true and correct.

Bidder's Signature

Date

Name of Bidding Firm: _____

BID FORM

BID NO. 316014

PROJECT: COUNTY HIGHWAY FACILITY SATELLITE BUILDING

**TO: DANE COUNTY DEPARTMENT OF PUBLIC WORKS, HIGHWAY & TRANSPORTATION PROJECT MANAGER
1919 ALLIANT ENERGY CENTER WAY
MADISON, WISCONSIN 53713**

NOTE: WISCONSIN STATUTE 77.54 (9M) ALLOWS FOR NO SALES & USE TAX ON THE PURCHASE OF MATERIALS FOR COUNTY PUBLIC WORKS PROJECTS.

BASE BID - LUMP SUM:

Dane County is inviting Bids for construction services for a new pre-engineered metal building that is approximately 40' by 120' in size, as outlined in the project drawings and construction documents.. The undersigned, having examined the site where the Work is to be executed and having become familiar with local conditions affecting the cost of the Work and having carefully examined the Drawings and Specifications, all other Construction Documents and Addenda thereto prepared by Dane County Department of Public Works, Highway & Transportation hereby agrees to provide all labor, materials, equipment and services necessary for the complete and satisfactory execution of the entire Work, as specified in the Construction Documents, for the Base Bid stipulated sum of:

_____ and _____ /100 Dollars
Written Price

\$ _____
Numeric Price

Receipt of the following addenda and inclusion of their provisions in this Bid is hereby acknowledged:

Addendum No(s). _____ through _____

Dated _____

Dane County Public Works, Highway & Transportation must have this project completed by November 1,2016. Assuming this Work can be started by August 1, 2016 what dates can you commence and complete this job?

Commencement Date: _____ Completion Date: _____
(final, not substantial)

I hereby certify that all statements herein are made on behalf of:

(Name of Corporation, Partnership or Person submitting Bid)

Select one of the following:

1. A corporation organized and existing under the laws of the State of _____, or
2. A partnership consisting of _____, or
3. A person conducting business as _____;

Of the City, Village, or Town of _____ of the State of _____.

I have examined and carefully prepared this Bid from the associated Construction Documents and have checked the same in detail before submitting this Bid; that I have full authority to make such statements and submit this Bid in (its) (their) (my) behalf; and that the said statements are true and correct. In signing this Bid, we also certify that we have not, either directly or indirectly, entered into any agreement or participated in any collusion or otherwise taken any action in restraint of free competition; that no attempt has been made to induce any other person or firm to submit or not to submit a Bid; that this Bid has been independently arrived at without collusion with any other bidder, competitor, or potential competitor; that this Bid has not been knowingly disclosed prior to the Bids Due Date to another bidder or competitor; that the above statement is accurate under penalty of perjury.

The undersigned further agrees to honor the Base Bid and the Alternate Bid(s) for sixty (60) calendar days from date of Award of Contract.

SIGNATURE: _____
(Bid is invalid without signature)

Print Name: _____ Date: _____

Title: _____

Address: _____

Telephone No.: _____ Fax No.: _____

Email Address: _____

Contact Person: _____

THIS PAGE IS FOR BIDDERS' REFERENCE AND NEED NOT BE SUBMITTED WITH BID FORM.

BID CHECK LIST:

These items **must** be included with Bid:

Bid Form

Bid Bond

Fair Labor Practices Certification

BIDDERS SHOULD BE AWARE OF THE FOLLOWING:

DANE COUNTY VENDOR REGISTRATION PROGRAM

Any person bidding on any County contract must be registered with the Dane County Purchasing Division & pay an annual registration fee. A contract will not be awarded to an unregistered vendor. Obtain a *Vendor Registration Form* by calling 608/266-4131 or complete a new form or renewal online at:

www.danepurchasing.com/registration

DANE COUNTY BEST VALUE CONTRACTING PRE-QUALIFICATION

Contractors must be pre-qualified as a Best Value Contractor with the Dane County Public Works Engineering Division before the award of contract. Obtain a *Best Value Contracting Application* by calling 608/266-4018 or complete one online at:

www.countyofdane.com/pwht/BVC_Application.aspx

EQUAL BENEFITS REQUIREMENT

By submitting a Bid, the contractor acknowledges that a condition of this contract is to provide equal benefits as required by Dane County Code of Ordinances Chapter 25.016. Contractor shall provide equal benefits as required by that Ordinance to all required employees during the term of the contract. Equal Benefits Compliance Payment Certification shall be submitted with final pay request. For more information:

www.danepurchasing.com/partner_benefit.aspx

FAIR LABOR PRACTICES CERTIFICATION

The undersigned, for and on behalf of the BIDDER, APPLICANT or PROPOSER named herein, certifies as follows:

- A. That he or she is an officer or duly authorized agent of the above-referenced BIDDER, APPLICANT or PROPOSER, which has a submitted a bid, application or proposal for a contract or agreement with the county of Dane.
- B. That BIDDER, APPLICANT or PROPOSER has (check one):

_____ not been found by the National Labor Relations Board (“NLRB”) or the Wisconsin Employment Relations Commission (“WERC”) to have violated any statute or regulation regarding labor standards or relations in the seven years prior to the signature date of this Certification.

_____ been found by the National Labor Relations Board (“NLRB”) or the Wisconsin Employment Relations Commission (“WERC”) to have violated any statute or regulation regarding labor standards or relations in the seven years prior to the signature date of this Certification.

Officer or Authorized Agent Signature Date

Printed or Typed Name and Title

Printed or Typed Business Name

NOTE: You can find information regarding the violations described above at: www.nlrb.gov and werc.wi.gov.

For reference, Dane County Ordinance 25.11(28)(a) is as follows:
(28) BIDDER RESPONSIBILITY. (a) Any bid, application or proposal for any contract with the county, including public works contracts regulated under chapter 40, shall include a certification indicating whether the bidder has been found by the National Labor Relations Board (NLRB) or the Wisconsin Employment Relations Committee (WERC) to have violated any statute or regulation regarding labor standards or relations within the last seven years. The purchasing manager shall investigate any such finding and make a recommendation to the committee, which shall determine whether the conduct resulting in the finding affects the bidder’s responsibility to perform the contract.

If you indicated that the NLRB or WERC have found you to have such a violation, you must include copies of any relevant information regarding such violation with your proposal, bid or application.

Include this completed Certification with your bid, application or proposal.

COUNTY OF DANE

PUBLIC WORKS CONSTRUCTION CONTRACT

Contract No. _____ Bid No. 316014

Authority: 2015 RES - _____

THIS CONTRACT, made and entered into as of the date by which authorized representatives of both parties have affixed their signatures, by and between the County of Dane (hereafter referred to as "COUNTY") and _____ (hereafter, "CONTRACTOR"), and

WITNESSETH:

WHEREAS, COUNTY, whose address is c/o Assistant Public Works Director, 1919 Alliant Energy Center Way, Madison, WI 53713, desires to have CONTRACTOR provide a new pre-engineered metal building approximately 40' by 120' in size at the County Highway Facility at the intersection of U.S. Highway 151 and County Highway V. ("the Project"); and

WHEREAS, CONTRACTOR, whose address is _____ is able and willing to construct the Project, in accordance with the Construction Documents;

NOW, THEREFORE, in consideration of the above premises and the mutual covenants of the parties hereinafter set forth, the receipt and sufficiency of which is acknowledged by each party for itself, COUNTY and CONTRACTOR do agree as follows:

1. CONTRACTOR agrees to construct, for the price of \$ _____ the Project and at the CONTRACTOR'S own proper cost and expense to furnish all materials, supplies, machinery, equipment, tools, superintendence labor, insurance, and other accessories and services necessary to complete the Project in accordance with the conditions and prices stated in the Bid Form, General Conditions of Contract, the drawings which include all maps, plats, plans, and other drawings and printed or written explanatory matter thereof, and the specifications therefore as prepared by _____ (hereinafter referred to as "the Architect / Engineer"), and as enumerated in the Project Manual Table of Contents, all of which are made a part hereof and collectively evidence and constitute the Contract.

2. COUNTY agrees to pay the CONTRACTOR in current funds for the performance of the Contract subject to additions and deductions, as provided in the General Conditions of Contract, and to make payments on account thereof as provided in Article entitled, "Payments to Contractor" of the General Conditions of Contract.

3. During the term of this Contract, CONTRACTOR agrees to take affirmative action to ensure equal employment opportunities. The CONTRACTOR agrees in accordance with Wisconsin Statute 111.321 and Chapter 19 of the Dane County Code of Ordinances not to discriminate on the basis of age, race, ethnicity, religion, color, gender, disability, marital status, sexual orientation, national origin, cultural differences, ancestry, physical appearance, arrest record or conviction record, military participation or membership in the national guard, state defense force or any other reserve component of the military forces of the United States, or political beliefs.

Such equal opportunity shall include, but not be limited to, the following: employment, upgrading, demotion, transfer, recruitment, advertising, layoff, termination, training, rates of pay, and any other form of compensation. CONTRACTOR agrees to post in conspicuous places, available to all employees and applicants for employment, notices setting forth the provisions of this paragraph.

4. CONTRACTOR shall file an Affirmative Action Plan with the Dane County Contract Compliance Officer in accord with Chapter 19 of the Dane County Code of Ordinances. CONTRACTOR must file such plan within fifteen (15) business days of the effective date of this Contract. During the term of this Contract CONTRACTOR shall also provide copies of all announcements of employment opportunities to COUNTY'S Contract Compliance Office, and shall report annually the number of persons, by race, ethnicity, gender, and disability status, which apply for employment and, similarly classified, the number hired and number rejected.

5. During the term of this Contract, all solicitations for employment placed on CONTRACTOR'S behalf shall include a statement to the effect that CONTRACTOR is an "Equal Opportunity Employer".

6. CONTRACTOR agrees to comply with provisions of Chapter 25.016 of the Dane County Code of Ordinances, which pertains to domestic partnership benefits.

7. CONTRACTOR agrees to furnish all information and reports required by COUNTY'S Contract Compliance Officer as the same relate to affirmative action and nondiscrimination, which may include any books, records, or accounts deemed appropriate to determine compliance with Chapter 19, Dane County Code of Ordinances, and the provisions of this Contract.

8. CONTRACTOR agrees that all persons employed by CONTRACTOR or any subcontractor shall be paid no less than the minimum wage established under Chapter 40, Subchapter II, Dane County Code of Ordinances. CONTRACTOR agrees to abide by and comply with the provisions of Chapter 40, Subchapter II of the Dane County Code of Ordinances, and said Subchapter is fully incorporated herein by reference.

9. This Contract is intended to be a Contract solely between the parties hereto and for their benefit only. No part of this Contract shall be construed to add to, supplement, amend, abridge or repeal existing rights, benefits or privileges of any third party or parties including, but not limited to, employees of either of the parties.

10. The entire agreement of the parties is contained herein and this Contract supersedes any and all oral agreements and negotiations between the parties relating to the subject matter hereof. The parties expressly agree that the express terms of this Contract shall not be amended in any fashion except in writing, executed by both parties.

11. CONTRACTOR must be pre-qualified as a Best Value Contractor with Dane County Public Works Engineering Division before award of Contract. Subcontractors must be pre-qualified ten (10) business days prior to commencing Work under this Contract.

IN WITNESS WHEREOF, COUNTY and CONTRACTOR, by their respective authorized agents, have caused this Contract and its Schedules to be executed, effective as of the date by which all parties hereto have affixed their respective signatures, as indicated below.

* * * * *

FOR CONTRACTOR:

Signature Date

Printed or Typed Name and Title

Signature Date

Printed or Typed Name and Title

NOTE: If CONTRACTOR is a corporation, Secretary should attest. In accordance with IRS Regulations, unincorporated entities are required to provide either their Social Security or Employer Number in order to receive payment for services rendered.

* * * * *

This Contract is not valid or effectual for any purpose until approved by the appropriate authority designated below, and no work is authorized until the CONTRACTOR has been given notice to proceed by COUNTY'S Assistant Public Works Director.

FOR COUNTY:

Joseph T. Parisi, County Executive Date

Scott McDonell, County Clerk Date

Sample

AIA[®] Document A310[™] – 2010

Bid Bond

CONTRACTOR:

(Name, legal status and address)

SURETY:

(Name, legal status and principal place of business)

OWNER:

(Name, legal status and address)

BOND AMOUNT:**PROJECT:**

(Name, location or address, and Project number, if any)

This document has important legal consequences. Consultation with an attorney is encouraged with respect to its completion or modification.

Any singular reference to Contractor, Surety, Owner or other party shall be considered plural where applicable.

The Contractor and Surety are bound to the Owner in the amount set forth above, for the payment of which the Contractor and Surety bind themselves, their heirs, executors, administrators, successors and assigns, jointly and severally, as provided herein. The conditions of this Bond are such that if the Owner accepts the bid of the Contractor within the time specified in the bid documents, or within such time period as may be agreed to by the Owner and Contractor, and the Contractor either (1) enters into a contract with the Owner in accordance with the terms of such bid, and gives such bond or bonds as may be specified in the bidding or Contract Documents, with a surety admitted in the jurisdiction of the Project and otherwise acceptable to the Owner, for the faithful performance of such Contract and for the prompt payment of labor and material furnished in the prosecution thereof; or (2) pays to the Owner the difference, not to exceed the amount of this Bond, between the amount specified in said bid and such larger amount for which the Owner may in good faith contract with another party to perform the work covered by said bid, then this obligation shall be null and void, otherwise to remain in full force and effect. The Surety hereby waives any notice of an agreement between the Owner and Contractor to extend the time in which the Owner may accept the bid. Waiver of notice by the Surety shall not apply to any extension exceeding sixty (60) days in the aggregate beyond the time for acceptance of bids specified in the bid documents, and the Owner and Contractor shall obtain the Surety's consent for an extension beyond sixty (60) days.

If this Bond is issued in connection with a subcontractor's bid to a Contractor, the term Contractor in this Bond shall be deemed to be Subcontractor and the term Owner shall be deemed to be Contractor.

When this Bond has been furnished to comply with a statutory or other legal requirement in the location of the Project, any provision in this Bond conflicting with said statutory or legal requirement shall be deemed deleted herefrom and provisions conforming to such statutory or other legal requirement shall be deemed incorporated herein. When so furnished, the intent is that this Bond shall be construed as a statutory bond and not as a common law bond.

Signed and sealed this _____ day of _____

_____	(Contractor as Principal)	_____	(Seal)
(Witness)		_____	(Title)
		_____	(Surety)
_____		_____	(Seal)
(Witness)		_____	(Title)

CAUTION: You should sign an original AIA Contract Document, on which this text appears in RED. An original assures that changes will not be obscured.

AIA[®] Document A312[™] – 2010

Performance Bond

CONTRACTOR:

(Name, legal status and address)

SURETY:

(Name, legal status and principal place of business)

OWNER:

(Name, legal status and address)

This document has important legal consequences. Consultation with an attorney is encouraged with respect to its completion or modification.

Any singular reference to Contractor, Surety, Owner or other party shall be considered plural where applicable.

AIA Document A312–2010 combines two separate bonds, a Performance Bond and a Payment Bond, into one form. This is not a single combined Performance and Payment Bond.

CONSTRUCTION CONTRACT

Date:

Amount:

Description:

(Name and location)

BOND

Date:

(Not earlier than Construction Contract Date)

Amount:

Modifications to this Bond: None See Section 16

CONTRACTOR AS PRINCIPAL

Company: *(Corporate Seal)*

SURETY

Company: *(Corporate Seal)*

Signature: _____

Name _____
and Title: _____

Signature: _____

Name _____
and Title: _____

(Any additional signatures appear on the last page of this Performance Bond.)

(FOR INFORMATION ONLY — Name, address and telephone)

AGENT or BROKER:

OWNER'S REPRESENTATIVE:

(Architect, Engineer or other party:)

§ 1 The Contractor and Surety, jointly and severally, bind themselves, their heirs, executors, administrators, successors and assigns to the Owner for the performance of the Construction Contract, which is incorporated herein by reference.

§ 2 If the Contractor performs the Construction Contract, the Surety and the Contractor shall have no obligation under this Bond, except when applicable to participate in a conference as provided in Section 3.

§ 3 If there is no Owner Default under the Construction Contract, the Surety's obligation under this Bond shall arise after

- .1 the Owner first provides notice to the Contractor and the Surety that the Owner is considering declaring a Contractor Default. Such notice shall indicate whether the Owner is requesting a conference among the Owner, Contractor and Surety to discuss the Contractor's performance. If the Owner does not request a conference, the Surety may, within five (5) business days after receipt of the Owner's notice, request such a conference. If the Surety timely requests a conference, the Owner shall attend. Unless the Owner agrees otherwise, any conference requested under this Section 3.1 shall be held within ten (10) business days of the Surety's receipt of the Owner's notice. If the Owner, the Contractor and the Surety agree, the Contractor shall be allowed a reasonable time to perform the Construction Contract, but such an agreement shall not waive the Owner's right, if any, subsequently to declare a Contractor Default;
- .2 the Owner declares a Contractor Default, terminates the Construction Contract and notifies the Surety; and
- .3 the Owner has agreed to pay the Balance of the Contract Price in accordance with the terms of the Construction Contract to the Surety or to a contractor selected to perform the Construction Contract.

§ 4 Failure on the part of the Owner to comply with the notice requirement in Section 3.1 shall not constitute a failure to comply with a condition precedent to the Surety's obligations, or release the Surety from its obligations, except to the extent the Surety demonstrates actual prejudice.

§ 5 When the Owner has satisfied the conditions of Section 3, the Surety shall promptly and at the Surety's expense take one of the following actions:

§ 5.1 Arrange for the Contractor, with the consent of the Owner, to perform and complete the Construction Contract;

§ 5.2 Undertake to perform and complete the Construction Contract itself, through its agents or independent contractors;

§ 5.3 Obtain bids or negotiated proposals from qualified contractors acceptable to the Owner for a contract for performance and completion of the Construction Contract, arrange for a contract to be prepared for execution by the Owner and a contractor selected with the Owner's concurrence, to be secured with performance and payment bonds executed by a qualified surety equivalent to the bonds issued on the Construction Contract, and pay to the Owner the amount of damages as described in Section 7 in excess of the Balance of the Contract Price incurred by the Owner as a result of the Contractor Default; or

§ 5.4 Waive its right to perform and complete, arrange for completion, or obtain a new contractor and with reasonable promptness under the circumstances:

- .1 After investigation, determine the amount for which it may be liable to the Owner and, as soon as practicable after the amount is determined, make payment to the Owner; or
- .2 Deny liability in whole or in part and notify the Owner, citing the reasons for denial.

§ 6 If the Surety does not proceed as provided in Section 5 with reasonable promptness, the Surety shall be deemed to be in default on this Bond seven days after receipt of an additional written notice from the Owner to the Surety demanding that the Surety perform its obligations under this Bond, and the Owner shall be entitled to enforce any remedy available to the Owner. If the Surety proceeds as provided in Section 5.4, and the Owner refuses the payment or the Surety has denied liability, in whole or in part, without further notice the Owner shall be entitled to enforce any remedy available to the Owner.

§ 7 If the Surety elects to act under Section 5.1, 5.2 or 5.3, then the responsibilities of the Surety to the Owner shall not be greater than those of the Contractor under the Construction Contract, and the responsibilities of the Owner to the Surety shall not be greater than those of the Owner under the Construction Contract. Subject to the commitment by the Owner to pay the Balance of the Contract Price, the Surety is obligated, without duplication, for

- .1 the responsibilities of the Contractor for correction of defective work and completion of the Construction Contract;
- .2 additional legal, design professional and delay costs resulting from the Contractor's Default, and resulting from the actions or failure to act of the Surety under Section 5; and
- .3 liquidated damages, or if no liquidated damages are specified in the Construction Contract, actual damages caused by delayed performance or non-performance of the Contractor.

§ 8 If the Surety elects to act under Section 5.1, 5.3 or 5.4, the Surety's liability is limited to the amount of this Bond.

§ 9 The Surety shall not be liable to the Owner or others for obligations of the Contractor that are unrelated to the Construction Contract, and the Balance of the Contract Price shall not be reduced or set off on account of any such unrelated obligations. No right of action shall accrue on this Bond to any person or entity other than the Owner or its heirs, executors, administrators, successors and assigns.

§ 10 The Surety hereby waives notice of any change, including changes of time, to the Construction Contract or to related subcontracts, purchase orders and other obligations.

§ 11 Any proceeding, legal or equitable, under this Bond may be instituted in any court of competent jurisdiction in the location in which the work or part of the work is located and shall be instituted within two years after a declaration of Contractor Default or within two years after the Contractor ceased working or within two years after the Surety refuses or fails to perform its obligations under this Bond, whichever occurs first. If the provisions of this Paragraph are void or prohibited by law, the minimum period of limitation available to sureties as a defense in the jurisdiction of the suit shall be applicable.

§ 12 Notice to the Surety, the Owner or the Contractor shall be mailed or delivered to the address shown on the page on which their signature appears.

§ 13 When this Bond has been furnished to comply with a statutory or other legal requirement in the location where the construction was to be performed, any provision in this Bond conflicting with said statutory or legal requirement shall be deemed deleted herefrom and provisions conforming to such statutory or other legal requirement shall be deemed incorporated herein. When so furnished, the intent is that this Bond shall be construed as a statutory bond and not as a common law bond.

§ 14 Definitions

§ 14.1 **Balance of the Contract Price.** The total amount payable by the Owner to the Contractor under the Construction Contract after all proper adjustments have been made, including allowance to the Contractor of any amounts received or to be received by the Owner in settlement of insurance or other claims for damages to which the Contractor is entitled, reduced by all valid and proper payments made to or on behalf of the Contractor under the Construction Contract.

§ 14.2 **Construction Contract.** The agreement between the Owner and Contractor identified on the cover page, including all Contract Documents and changes made to the agreement and the Contract Documents.

§ 14.3 **Contractor Default.** Failure of the Contractor, which has not been remedied or waived, to perform or otherwise to comply with a material term of the Construction Contract.

§ 14.4 **Owner Default.** Failure of the Owner, which has not been remedied or waived, to pay the Contractor as required under the Construction Contract or to perform and complete or comply with the other material terms of the Construction Contract.

§ 14.5 **Contract Documents.** All the documents that comprise the agreement between the Owner and Contractor.

§ 15 If this Bond is issued for an agreement between a Contractor and subcontractor, the term Contractor in this Bond shall be deemed to be Subcontractor and the term Owner shall be deemed to be Contractor.

§ 16 Modifications to this bond are as follows:

Sample

(Space is provided below for additional signatures of added parties, other than those appearing on the cover page.)

CONTRACTOR AS PRINCIPAL

SURETY

Company: _____

(Corporate Seal)

Company: _____

(Corporate Seal)

Signature: _____

Name and Title: _____

Address _____

Signature: _____

Name and Title: _____

Address _____

CAUTION: You should sign an original AIA Contract Document, on which this text appears in RED. An original assures that changes will not be obscured.



AIA® Document A312™ – 2010

Payment Bond

CONTRACTOR:

(Name, legal status and address)

SURETY:

(Name, legal status and principal place of business)

OWNER:

(Name, legal status and address)

This document has important legal consequences. Consultation with an attorney is encouraged with respect to its completion or modification.

Any singular reference to Contractor, Surety, Owner or other party shall be considered plural where applicable.

AIA Document A312–2010 combines two separate bonds, a Performance Bond and a Payment Bond, into one form. This is not a single combined Performance and Payment Bond.

CONSTRUCTION CONTRACT

Date:

Amount:

Description:

(Name and location)

BOND

Date:

(Not earlier than Construction Contract Date)

Amount:

Modifications to this Bond: None See Section 18

CONTRACTOR AS PRINCIPAL

Company: *(Corporate Seal)*

SURETY

Company: *(Corporate Seal)*

Signature: _____

Name _____
and Title: _____

Signature: _____

Name _____
and Title: _____

(Any additional signatures appear on the last page of this Payment Bond.)

(FOR INFORMATION ONLY — Name, address and telephone)

AGENT or BROKER:**OWNER'S REPRESENTATIVE:**

(Architect, Engineer or other party:)

§ 1 The Contractor and Surety, jointly and severally, bind themselves, their heirs, executors, administrators, successors and assigns to the Owner to pay for labor, materials and equipment furnished for use in the performance of the Construction Contract, which is incorporated herein by reference, subject to the following terms.

§ 2 If the Contractor promptly makes payment of all sums due to Claimants, and defends, indemnifies and holds harmless the Owner from claims, demands, liens or suits by any person or entity seeking payment for labor, materials or equipment furnished for use in the performance of the Construction Contract, then the Surety and the Contractor shall have no obligation under this Bond.

§ 3 If there is no Owner Default under the Construction Contract, the Surety's obligation to the Owner under this Bond shall arise after the Owner has promptly notified the Contractor and the Surety (at the address described in Section 13) of claims, demands, liens or suits against the Owner or the Owner's property by any person or entity seeking payment for labor, materials or equipment furnished for use in the performance of the Construction Contract and tendered defense of such claims, demands, liens or suits to the Contractor and the Surety.

§ 4 When the Owner has satisfied the conditions in Section 3, the Surety shall promptly and at the Surety's expense defend, indemnify and hold harmless the Owner against a duly tendered claim, demand, lien or suit.

§ 5 The Surety's obligations to a Claimant under this Bond shall arise after the following:

§ 5.1 Claimants, who do not have a direct contract with the Contractor,

- .1 have furnished a written notice of non-payment to the Contractor, stating with substantial accuracy the amount claimed and the name of the party to whom the materials were, or equipment was, furnished or supplied or for whom the labor was done or performed, within ninety (90) days after having last performed labor or last furnished materials or equipment included in the Claim; and
- .2 have sent a Claim to the Surety (at the address described in Section 13).

§ 5.2 Claimants, who are employed by or have a direct contract with the Contractor, have sent a Claim to the Surety (at the address described in Section 13).

§ 6 If a notice of non-payment required by Section 5.1.1 is given by the Owner to the Contractor, that is sufficient to satisfy a Claimant's obligation to furnish a written notice of non-payment under Section 5.1.1.

§ 7 When a Claimant has satisfied the conditions of Sections 5.1 or 5.2, whichever is applicable, the Surety shall promptly and at the Surety's expense take the following actions:

§ 7.1 Send an answer to the Claimant, with a copy to the Owner, within sixty (60) days after receipt of the Claim, stating the amounts that are undisputed and the basis for challenging any amounts that are disputed; and

§ 7.2 Pay or arrange for payment of any undisputed amounts.

§ 7.3 The Surety's failure to discharge its obligations under Section 7.1 or Section 7.2 shall not be deemed to constitute a waiver of defenses the Surety or Contractor may have or acquire as to a Claim, except as to undisputed amounts for which the Surety and Claimant have reached agreement. If, however, the Surety fails to discharge its obligations under Section 7.1 or Section 7.2, the Surety shall indemnify the Claimant for the reasonable attorney's fees the Claimant incurs thereafter to recover any sums found to be due and owing to the Claimant.

§ 8 The Surety's total obligation shall not exceed the amount of this Bond, plus the amount of reasonable attorney's fees provided under Section 7.3, and the amount of this Bond shall be credited for any payments made in good faith by the Surety.

§ 9 Amounts owed by the Owner to the Contractor under the Construction Contract shall be used for the performance of the Construction Contract and to satisfy claims, if any, under any construction performance bond. By the Contractor furnishing and the Owner accepting this Bond, they agree that all funds earned by the Contractor in the performance of the Construction Contract are dedicated to satisfy obligations of the Contractor and Surety under this Bond, subject to the Owner's priority to use the funds for the completion of the work.

§ 10 The Surety shall not be liable to the Owner, Claimants or others for obligations of the Contractor that are unrelated to the Construction Contract. The Owner shall not be liable for the payment of any costs or expenses of any Claimant under this Bond, and shall have under this Bond no obligation to make payments to, or give notice on behalf of, Claimants or otherwise have any obligations to Claimants under this Bond.

§ 11 The Surety hereby waives notice of any change, including changes of time, to the Construction Contract or to related subcontracts, purchase orders and other obligations.

§ 12 No suit or action shall be commenced by a Claimant under this Bond other than in a court of competent jurisdiction in the state in which the project that is the subject of the Construction Contract is located or after the expiration of one year from the date (1) on which the Claimant sent a Claim to the Surety pursuant to Section 5.1.2 or 5.2, or (2) on which the last labor or service was performed by anyone or the last materials or equipment were furnished by anyone under the Construction Contract, whichever of (1) or (2) first occurs. If the provisions of this Paragraph are void or prohibited by law, the minimum period of limitation available to sureties as a defense in the jurisdiction of the suit shall be applicable.

§ 13 Notice and Claims to the Surety, the Owner or the Contractor shall be mailed or delivered to the address shown on the page on which their signature appears. Actual receipt of notice or Claims, however accomplished, shall be sufficient compliance as of the date received.

§ 14 When this Bond has been furnished to comply with a statutory or other legal requirement in the location where the construction was to be performed, any provision in this Bond conflicting with said statutory or legal requirement shall be deemed deleted herefrom and provisions conforming to such statutory or other legal requirement shall be deemed incorporated herein. When so furnished, the intent is that this Bond shall be construed as a statutory bond and not as a common law bond.

§ 15 Upon request by any person or entity appearing to be a potential beneficiary of this Bond, the Contractor and Owner shall promptly furnish a copy of this Bond or shall permit a copy to be made.

§ 16 Definitions

§ 16.1 Claim. A written statement by the Claimant including at a minimum:

- .1 the name of the Claimant;
- .2 the name of the person for whom the labor was done, or materials or equipment furnished;
- .3 a copy of the agreement or purchase order pursuant to which labor, materials or equipment was furnished for use in the performance of the Construction Contract;
- .4 a brief description of the labor, materials or equipment furnished;
- .5 the date on which the Claimant last performed labor or last furnished materials or equipment for use in the performance of the Construction Contract;
- .6 the total amount earned by the Claimant for labor, materials or equipment furnished as of the date of the Claim;
- .7 the total amount of previous payments received by the Claimant; and
- .8 the total amount due and unpaid to the Claimant for labor, materials or equipment furnished as of the date of the Claim.

§ 16.2 Claimant. An individual or entity having a direct contract with the Contractor or with a subcontractor of the Contractor to furnish labor, materials or equipment for use in the performance of the Construction Contract. The term Claimant also includes any individual or entity that has rightfully asserted a claim under an applicable mechanic's lien or similar statute against the real property upon which the Project is located. The intent of this Bond shall be to include without limitation in the terms "labor, materials or equipment" that part of water, gas, power, light, heat, oil, gasoline, telephone service or rental equipment used in the Construction Contract, architectural and engineering services required for performance of the work of the Contractor and the Contractor's subcontractors, and all other items for which a mechanic's lien may be asserted in the jurisdiction where the labor, materials or equipment were furnished.

§ 16.3 Construction Contract. The agreement between the Owner and Contractor identified on the cover page, including all Contract Documents and all changes made to the agreement and the Contract Documents.

§ 16.4 **Owner Default.** Failure of the Owner, which has not been remedied or waived, to pay the Contractor as required under the Construction Contract or to perform and complete or comply with the other material terms of the Construction Contract.

§ 16.5 **Contract Documents.** All the documents that comprise the agreement between the Owner and Contractor.

§ 17 If this Bond is issued for an agreement between a Contractor and subcontractor, the term Contractor in this Bond shall be deemed to be Subcontractor and the term Owner shall be deemed to be Contractor.

§ 18 Modifications to this bond are as follows:

(Space is provided below for additional signatures of added parties, other than those appearing on the cover page.)

CONTRACTOR AS PRINCIPAL

Company: _____

(Corporate Seal)

SURETY

Company: _____

(Corporate Seal)

Signature: _____

Name and Title: _____

Address _____

Signature: _____

Name and Title: _____

Address _____

CAUTION: You should sign an original AIA Contract Document, on which this text appears in RED. An original assures that changes will not be obscured.

EQUAL BENEFITS COMPLIANCE PAYMENT CERTIFICATION FORM

PURPOSE

25.016(8) of the Dane County Ordinance requires that each contractor receiving payment for contracted services must certify that he or she has complied fully with the requirements of Chapter 25.016 "Equal Benefits Requirement" of the Dane County Ordinances. Such certification must be submitted prior to the final payment on the contract.

This form should be included with a copy of the final contract invoice forwarded to your contract representative at Dane County.

CERTIFICATION

I, _____ certify that
Printed or Typed Name and Title

Printed or Typed Name of Contractor

has complied fully with the requirements of Chapter 25.016 of the Dane County Ordinances "Equal Benefits Requirements".

Signed _____

Date _____

For questions on this form, please contact Chuck Hicklin at 608-266-4109 or your contract representative at Dane County.

GENERAL CONDITIONS OF CONTRACT

TABLE OF CONTENTS

1. CONSTRUCTION DOCUMENTS	2
2. DEFINITIONS	2
3. ADDITIONAL INSTRUCTIONS AND DRAWINGS	2
4. SHOP DRAWINGS, PRODUCT DATA AND SAMPLES	3
5. CUTTING AND PATCHING.....	3
6. CLEANING UP	4
7. USE OF SITE.....	4
8. MATERIALS AND WORKMANSHIP	5
9. CONTRACTOR'S TITLE TO MATERIALS	5
10. "OR EQUAL" CLAUSE.....	5
11. PATENTS AND ROYALTIES.....	6
12. SURVEYS, PERMITS, REGULATIONS AND TAXES.....	6
13. CONTRACTOR'S OBLIGATIONS AND SUPERINTENDENCE.....	7
14. WEATHER CONDITIONS	8
15. PROTECTION OF WORK AND PROPERTY	8
16. INSPECTION AND TESTING OF MATERIALS	8
17. REPORTS, RECORDS AND DATA	9
18. CHANGES IN THE WORK	9
19. EXTRAS	10
20. TIME FOR COMPLETION.....	10
21. CORRECTION OF WORK.....	10
22. SUBSURFACE CONDITIONS FOUND DIFFERENT	10
23. RIGHT OF DEPARTMENT TO TERMINATE CONTRACT	11
24. CONSTRUCTION SCHEDULE AND PERIODIC ESTIMATES	11
25. PAYMENTS TO CONTRACTOR	12
26. WITHHOLDING OF PAYMENTS.....	13
27. ACCEPTANCE OF FINAL PAYMENT AS RELEASE	14
28. PAYMENTS BY CONTRACTOR.....	14
29. CONTRACT SECURITY	14
30. ASSIGNMENTS.....	14
31. MUTUAL RESPONSIBILITY OF CONTRACTORS	15
32. SEPARATE CONTRACTS	15
33. SUBCONTRACTS	15
34. PUBLIC WORKS PROJECT MANAGER'S AUTHORITY	16
35. ARCHITECT / ENGINEER'S AUTHORITY	16
36. STATED ALLOWANCES	16
37. ESTIMATES OF QUANTITIES	17
38. LANDS AND RIGHTS-OF-WAY	17
39. GENERAL GUARANTEE.....	17
40. CONFLICTING CONDITIONS	18
41. NOTICE AND SERVICE THEREOF	18
42. PROTECTION OF LIVES AND HEALTH	18
43. AFFIRMATIVE ACTION PROVISION AND MINORITY / WOMEN / DISADVANTAGED BUSINESS ENTERPRISES	18
44. COMPLIANCE WITH FAIR LABOR STANDARDS	19
45. DOMESTIC PARTNERSHIP BENEFITS	19
46. USE AND OCCUPANCY PRIOR TO ACCEPTANCE	20
47. MINIMUM WAGES	20
48. CLAIMS	21
49. ANTITRUST AGREEMENT	21
50. INSURANCE.....	21
51. WISCONSIN LAW CONTROLLING	23

1. CONSTRUCTION DOCUMENTS

- A. Construction Documents, listed in Table of Contents of this Specification volume shall form part of this Contract and provisions of Construction Documents shall be as binding upon parties as if they were fully set forth in Contract itself.
- B. These shall also be considered as part of Construction Documents: Addenda, including additions and modifications incorporated in such addenda before execution of Contract; requests for information; construction bulletins; change orders; and written interpretations by Architect / Engineer or Public Works Project Manager that are made after execution of Contract.
- C. Construction Documents are complementary, and what is required by one shall be as binding as if required by all. Intent of Construction Documents is to include all labor, materials and equipment necessary for proper execution of the Work.

2. DEFINITIONS

- A. These terms as used in this Contract are respectively defined as follows:
 - 1. All uses of term “County” in Construction Documents shall mean Dane County.
 - 2. All uses of term “Department” in Construction Documents shall mean Department of Public Works, Highway & Transportation, which is a unit of Dane County government. Department is County agency overseeing Contract with Contractor.
 - 3. Public Works Project Manager is appointed by and responsible to Department. Public Works Project Manager has authority to act on behalf of Department and will sign change orders, payment requests and other administrative matters related to projects.
 - 4. Public Works Project Manager is responsible for supervision, administration and management of field operations involved in construction phase of this Work.
 - 5. Term “Work” includes all labor, equipment and materials necessary to produce project required by Construction Documents.
 - 6. Term “Substantial Completion” is date when project or specified area of project is certified by Architect / Engineer that construction is sufficiently completed, in accordance with Construction Documents, and as modified by any subsequent changes agreed to by parties, so that County may occupy project or specified area of project for use for which it was intended subject to permit approval for occupancy.
 - 7. Contractor is person, firm, or corporation with whom County makes Contract. Though multiple contracts may be involved, Construction Documents treat them throughout as if each were of singular number.

3. ADDITIONAL INSTRUCTIONS AND DRAWINGS

- A. Contractor may be furnished additional instructions and detail drawings as necessary to carry out the Work included in Contract. Additional drawings and instructions thus supplied to Contractor will coordinate with Construction Documents and will be so prepared that they can be reasonably interpreted as part thereof. Contractor shall carry out the Work in accordance with additional detail drawings and instructions.

4. SHOP DRAWINGS, PRODUCT DATA AND SAMPLES

- A. Unless otherwise specified, Contractor shall submit three (3) copies of all Shop Drawings for each submission, until receiving final approval. After final approval, provide five (5) additional copies for distribution and such other copies as may be required.
- B. Contractor shall submit, on an on-going basis and as directed, Product Data such as brochures that shall contain catalog cuts and specifications of all furnished mechanical and electrical equipment. After Architect / Engineer's approval, one (1) copy shall remain in Architect / Engineer's file, one (1) kept at Department's office and one (1) kept at job site by Contractor for reference purposes.
- C. Samples shall consist of physical examples furnished by Contractor in sufficient size and quantity to illustrate materials, equipment or workmanship, and to establish standards to compare the Work.
 - 1. Submit Samples in sufficient quantity (minimum of two (2)) to permit Architect / Engineer to make all necessary tests and of adequate size showing quality, type, color range, finish, and texture. Label each Sample stating material, type, color, thickness, size, project name, and Contractor's name.
 - 2. Submit transmittal letter requesting approval, and prepay transportation charges to Architect / Engineer's office on samples forwarded.
 - 3. Materials installed shall match approved Samples.
- D. Contractor shall review Shop Drawings and place their dated stamp thereon to evidence their review and approval and shall submit with reasonable promptness and in orderly sequence to cause no delay in the Work or in work of any other contractor. At time of submission, Contractor shall inform Architect / Engineer in writing of any deviation in Shop Drawings or Samples from requirements of Construction Documents. Architect / Engineer will not consider partial lists.
- E. Architect / Engineer will review and approve or reject Shop Drawings with reasonable promptness to cause no delay. Architect / Engineer's approval shall not relieve Contractor from responsibility for errors or omissions in Shop Drawings.
- F. Contractor shall not commence any work requiring Shop Drawing, Product Data or Sample submission until Architect / Engineer has approved submission. All such work shall be in accordance with approved Shop Drawings, Product Data and Samples.
- G. Contractor shall keep on site of the Work, approved or conformed copy of Shop Drawings and shall at all time give Department access thereto.
- H. By stamping and submitting Shop Drawings, Product Data and Samples, Contractor thereby represents that he or she has or will determine and verify all field measurements, field construction criteria, materials, catalog numbers, and similar data and that he or she has checked and coordinated each Shop Drawing, Product Data and Sample with requirements of the Work and of Construction Documents. Architect / Engineer shall return without examination, Shop Drawings, Product Data and Samples not so noted.
- I. All Shop Drawings from any one Contractor should be numbered consecutively and on cover sheet shall bear name and location of project, name of Contractor, date of submittal and date of each correction or revision and associated Specification section and page number.

5. CUTTING AND PATCHING

- A. Contractor shall be responsible for all cutting, fitting or patching required to complete the Work or to make its parts fit together properly.
- B. Contractor shall not damage or endanger portion of the Work or fully or partially completed construction of County or separate contractors by cutting, patching or otherwise altering such construction, or by excavation. Contractor shall not cut or otherwise alter such construction by County or separate contractor except with written consent of County and of such separate contractor; such consent shall not be unreasonably withheld. Contractor shall not withhold unreasonably from County or separate contractor, Contractor's consent to cutting or otherwise altering the Work.

6. CLEANING UP

- A. Contractor shall keep premises and surrounding area free from accumulation of waste materials or rubbish caused by operations under Contract. Contractor shall remove from and about the Work waste materials, rubbish, Contractor's tools, construction equipment, machinery, and surplus materials at completion of the Work. Contractor shall maintain streets and sidewalks around the Work site in clean condition. Contractor shall remove all spillage and prevent tracking of spillage arising from performance of the Work, into, out of, and within the Work site. Contractor shall establish regular maintenance program of sweeping, vacuuming and / or hosing to minimize accumulation of dirt and dust upon such areas.
- B. If Contractor fails to clean up as directed in Construction Documents, County may do so and shall charge Contractor cost thereof.
- C. Contractor shall be responsible for broken windows and glass, and at completion of the Work shall replace such damaged or broken windows and glass. After replacing damaged or broken windows and glass, Contractor shall remove all labels, wash and polish both sides of all windows and glass.
- D. In addition to general cleaning (sweeping, vacuuming and / or hosing, as is appropriate to work surface), Contractor shall perform following final cleaning for all trades at completion of the Work:
 - 1. Remove temporary protections;
 - 2. Remove marks, stains, fingerprints and other soil or dirt from painted, decorated and finished woodwork and wall surfaces;
 - 3. Remove spots, plaster, soil and paint from ceramic tile, marble and other finished materials, and wash or wipe clean;
 - 4. Clean fixtures, cabinet work and equipment, removing stains, paint, dirt and dust, and leave same in undamaged, new condition;
 - 5. Clean aluminum in accordance with recommendations of manufacturer; and
 - 6. Clean resilient floors thoroughly with well-rinsed mop containing only enough moisture to clean off any surface dirt or dust and buff dry by machine to bring surfaces to sheen.

7. USE OF SITE

- A. Contractor shall provide County and Architect / Engineer access to the Work under all circumstances.
- B. Contractor shall confine operations at site to areas permitted by County, law, ordinance, permits and Construction Documents and shall not unreasonably encumber site with materials

or equipment. Contractor shall assure free, convenient, unencumbered, direct and safe access to all properties adjacent to the Work for County, its employees, invitees and guests.

8. MATERIALS AND WORKMANSHIP

- A. Contractor shall perform all work and furnish all supplies and materials, machinery, equipment, facilities and means, necessary to complete the Work required by this Contract, within time specified, in accordance with provisions of Construction Documents.
- B. All equipment and materials incorporated in the Work covered by this Contract are to be new; use recycled and / or recovered materials to extent that such use is technically and economically feasible. Recovered materials are products recovered from solid waste in form identical to original form for use that is same as, or similar to original use. Recycled materials are products manufactured from solid waste.
- C. If requested, Contractor shall furnish satisfactory evidence as to kind and quality of construction materials proposed or used. Contractor shall furnish to Architect / Engineer, for approval, manufacturer name and model, performance capacities and other pertinent information of machinery, mechanical, electrical or other types of equipment, which Contractor plans to install.
- D. If not otherwise provided, materials and labor called for in this Contract shall be provided and performed in accordance with established practice and standards recognized by Architects, Engineers, Department, and construction industry.
- E. Reference to "Standard" specifications of any association or manufacturer, or codes of County authorities, intends most recent printed edition or catalog in effect on date that corresponds with date of Construction Documents.
- F. Whenever reference is made in Specifications that work shall be "performed", "applied", in accordance with "manufacturer's directions or instructions", Contractor to whom those instructions are directed shall furnish three (3) printed copies of such instructions to Architect / Engineer before execution of the Work.

9. CONTRACTOR'S TITLE TO MATERIALS

- A. Contractor or any subcontractor shall not purchase materials or supplies for the Work subject to any chattel mortgage or under conditional sale contract or other agreement by which seller retains interest. Contractor warrants that all materials and supplies used in the Work are free from all liens, claims or encumbrances and Contractor has good title to them.

10. "OR EQUAL" CLAUSE

- A. Whenever equipment or materials are identified on Drawings or in Specifications by reference to manufacturer's or vendor's name, trade name, catalog number, and other identifying information, it is intended to establish standards; and any equipment or material of other manufacturers and vendors which will perform adequately duties imposed by general design will be considered equally accepted provided equipment or material so proposed is, in opinion of Architect / Engineer, of equal substance and function. Architect / Engineer and Department shall provide written approval before Contractor may purchase or install it.

- B. Equipment or materials of manufacturers, other than those named, may be used only upon following conditions:
1. That, in opinion of Architect / Engineer and Department, proposed material or equipment item is fully equal or superior (in design, materials, construction, workmanship, performance, finish, etc.) to named item. No compromise in quality level, however small, is acceptable.
 2. That, in substituting materials or equipment, Contractor assumes responsibility for any changes in system or for modifications required in adjacent or related work to accommodate such substitution despite Architect / Engineer's and Department's approval, and all costs growing out of approval of "or equal" items shall be responsibility of Contractor. No extra costs resulting from such approval shall become responsibility of Department, Architect / Engineer or any other separate Contractor.
 3. It shall be understood that use of materials or equipment other than those specified, or approved equal by Architect / Engineer and Department, shall constitute violation of Contract, and that Architect / Engineer and Department shall have right to require removal of such materials or equipment and their replacement with specified materials or equipment at Contractor's expense.
 4. Product and manufacturer named first in Specifications or on information shown on Drawings is basis of selection of manufactured items and equipment, particularly mechanical equipment. In using other than first named products or manufacturers, including those specified as additionally approved or acceptable, Contractor assumes responsibility for any changes in system and for modifications in any work required to accommodate them. Architect / Engineer's approval of such additionally acceptable products or manufacturers, either in Specifications or in Addendum, does not relieve Contractor from obligation to coordinate such optional products with other Contractors, whose work may be affected by them, and to pay all additional costs resulting from their inclusion into the Work. Contractor's liability shall include payment of Architect / Engineer's fees for any additional services made necessary by or directly connected to such product changes. No extra costs resulting from such changes shall become responsibility of Department, Architect / Engineer or any other separate Contractor.
- C. No request for approval of "or equal" materials will be entertained except from Contractor. Identify any request for substitution as substitution on Contractor's letter of transmittal and give reasons for substitution. Department may in its sole discretion allow substitutions of materials.

11. PATENTS AND ROYALTIES

- A. If Contractor uses any design, device or material covered by letters, patent or copyright, it is mutually agreed and understood, that, without exception, contract prices shall include all royalties or costs arising from use of such design, device or materials, in any way involved in the Work.
- B. Contractor shall indemnify and save harmless County from any and all claims for infringement by reason of use of such patent or copyright in connection with the Work agreed to be performed under this Contract, and shall indemnify County for any cost, expense or damage which it may be obliged to pay by reason of such infringement at any time during prosecution of the Work or after completion of the Work.

12. SURVEYS, PERMITS, REGULATIONS AND TAXES

- A. Department will furnish to Contractor all site, topography and property surveys necessary for execution of the Work.

- B. Contractor shall procure all permits, licenses and approvals necessary for execution of this Contract.
- C. Contractor shall give all notices and comply with all State of Wisconsin, Federal and local laws, codes, rules and regulations relating to performance of the Work, protection of adjacent property, and maintenance of passageways, guard fences or other protective facilities.
- D. Contractor shall pay all Sales, Consumer, Use and other similar taxes required by law.
- E. Contractor shall promptly notify Architect / Engineer of any variances of Drawings or Specifications with that of any State of Wisconsin, federal or local law, code, rule or regulation. Upon such notification, Architect / Engineer will require correction of variance to comply with applicable law, code, rule or regulation at no additional cost to Contractor.
- F. Work under this Contract shall comply with all applicable State of Wisconsin, Federal and local laws, codes and regulations.
- G. Contractor shall pay charges for water, sewer and other utility connections made by municipalities where required by Specifications.

13. CONTRACTOR'S OBLIGATIONS AND SUPERINTENDENCE

- A. Contractor shall provide and pay for all materials, labor, tools, equipment, transportation and superintendence necessary to execute, complete and deliver the Work within specified time. Contractor agrees to secure at their own expense all personnel necessary to carry out the Work. Such personnel shall not be deemed County employees nor shall they have or be deemed to have any direct contractual relationship with County.
- B. Performance of any work necessary after regular working hours, on Sundays or Legal Holidays shall be without additional expense to County. Performance of any work at site at other than normal working hours must be coordinated with Public Works Project Manager.
- C. Contractor shall furnish, erect, maintain and remove such temporary works as may be required.
- D. Contractor shall observe, comply with, and be subject to all terms, conditions, requirements and limitations of Construction Documents.
- E. At the Work site, Contractor shall give personal superintendence to the Work or shall employ construction superintendent or foreman, experienced in character of work covered by Contract, who shall have full authority to act for Contractor. Understand that such superintendent or foreman shall be acceptable to Architect / Engineer and Department.
- F. Remove from project or take other corrective action upon notice from Architect / Engineer or Department for Contractor's employees whose work is considered by Architect / Engineer or Department to be unsatisfactory, careless, incompetent, unskilled or otherwise objectionable.
- G. Contractor and subcontractors shall be required to conform to Labor Laws of State of Wisconsin and various acts amendatory and supplementary thereto and to other laws, ordinances and legal requirements applicable to the Work.

- H. Presence and observation of the Work by Architect / Engineer or Public Works Project Manager shall not relieve Contractor of any obligations.

14. WEATHER CONDITIONS

- A. In event of temporary suspension of work, or during inclement weather, or whenever Architect / Engineer shall direct, Contractor shall, and shall cause subcontractors to protect carefully all work and materials against damage or injury from weather. If, in opinion of Architect / Engineer or Department, any work or materials that have been damaged or injured due to failure on part of Contractor or any subcontractors so to protect the Work, such materials shall be removed and replaced at expense of Contractor.

15. PROTECTION OF WORK AND PROPERTY

- A. Contractor shall at all times safely guard County's property from injury or loss in connection with this Contract. Contractor shall at all times safely guard and protect the Work, and adjacent property, from damage. Contractor shall replace or make good any such damage, loss or injury unless such is caused directly by errors contained in Contract, or by County, or County's duly authorized representative.
- B. Contractor may act diligently, without previous instructions from Architect / Engineer and / or Department, in emergency that threatens loss or injury of property, or safety of life. Contractor shall notify Architect / Engineer and / or Department immediately thereafter. Promptly submit any claim for compensation by Contractor due to such extra work to Architect / Engineer and / or Department for approval as provided for in Article 18 herein.

16. INSPECTION AND TESTING OF MATERIALS

- A. Authorized representatives and agents of County government shall have access at all times to the Work wherever it is in preparation or progress and Contractor shall provide facilities for such access and for inspection.
- B. Should it be considered necessary or advisable at any time before final acceptance of the Work to make examination of work already completed, by removing or tearing out same, Contractor shall upon request, promptly furnish all necessary facilities, labor and materials. If such work is found to be defective in any aspect, due to fault of Contractor or subcontractors thereof, Contractor shall assume all expenses of such examination and of satisfactory reconstruction. Contractor will be reimbursed for such examination and replacement in accordance with Article 18 - A.3., of these General Conditions of Contract if such work is found to meet requirements of Contract.
- C. If Specifications, Architect / Engineer's, or Public Works Project Manager's instructions require any work to be specially tested or approved, Contractor shall give Architect / Engineer and Public Works Project Manager timely notice of its readiness for testing or inspection. Test all materials and equipment requiring testing in accordance with accepted or specified standards, as applicable. Architect / Engineer shall recommend laboratory or inspection agency and Department will select and pay for all initial laboratory inspection services. Should retesting be required, due to failure of initial testing, cost of such retesting shall be borne by Contractor.
- D. Cost of any testing performed by manufacturers or Contractor for substantiating acceptability of proposed substitution of materials and equipment, or necessary conformance testing in

conjunction with manufacturing processes or factory assemblage, shall be borne by Contractor or manufacturer responsible.

17. REPORTS, RECORDS AND DATA

- A. Contractor shall submit to Architect / Engineer and Public Works Project Manager such schedule of quantities and costs, progress schedules, payrolls, reports, estimates, invoices, records and other data as either may request concerning work performed or to be performed under this Contract.

18. CHANGES IN THE WORK

- A. Make no changes, except in cases of emergency, in the Work covered by approved Construction Documents without having prior written approval of Department. Charges or credits for the Work covered by approved change shall be determined by one of these methods:
1. Unit bid prices previously approved.
 2. Agreed lump sum based on actual cost of:
 - a) Labor, including foremen, and all fringe benefits that are associated with their wages.
 - b) Materials entering permanently into the Work.
 - c) Ownership or rental cost of construction tools and equipment during time of use on extra work.
 - d) Power and consumable supplies for operation of power equipment.
 - e) Workmen's Compensation Insurance, Contractor's Public Liability and Property Damage Insurance, and Comprehensive Automobile Liability Insurance.
 - f) Social Security and old age and unemployment contributions.
 - g) Add to cost under (2), fixed fee to be agreed upon, but not to exceed fifteen percent (15%) of actual cost of work performed with their own labor force. Fee shall be compensation to cover cost of supervision, overhead, bond, profit and any other general expense.
 - h) On that portion of the Work under (2) done under subcontract, Contractor may include not over seven and one-half percent (7½%) for supervision, overhead, bond, profit and any other general expense.
 - i) Department may require correct amount of costs with supporting vouchers; Contractor shall keep and present in such form as directed.
 3. Cost-plus work, with not-to-exceed dollar limit, based on actual cost of:
 - a) Labor, including foremen, and all fringe benefits that are associated with their wages.
 - b) Materials entering permanently into the Work.
 - c) Ownership or rental cost of construction tools and equipment during time of use on extra work. Rental cost cannot exceed fifty percent (50%) replacement value of rented equipment.
 - d) Power and consumable supplies for operation of power equipment.
 - e) Workmen's Compensation Insurance, Contractor's Public Liability and Property Damage Insurance, and Comprehensive Automobile Liability Insurance.
 - f) Social Security and old age and unemployment contributions.
 - g) To cost under (3), there shall be added fixed fee to be agreed upon but not to exceed fifteen percent (15%) of actual cost of work performed with their own labor force. Fee shall be compensation to cover cost of supervision, overhead, bond, profit, and any other general expense.
 - h) On that portion of the Work under (3) done under subcontract, Contractor may include not over seven and one-half percent (7½%) for supervision, overhead, bond, profit, and any other general expense.

- i) Contractor shall keep and present, in such form as directed, correct amount of cost together with such supporting vouchers as may be required by Department.
- B. If Contractor claims that by any instructions given by Architect / Engineer, Department, by drawings or otherwise, regarding performance of the Work or furnishing of material under Contract, involves extra cost, Contractor shall give Department written notice of cost thereof within two (2) weeks after receipt of such instructions and in any event before proceeding to execute work, unless delay in executing work would endanger life or property.
- C. No claim for extra work or cost shall be allowed unless it was done in pursuance of written Change Order from Architect / Engineer and approved by Department, as previously mentioned, and claim presented with payment request submitted after changed or extra work is completed.
- D. Negotiation of cost for change in the Work shall not be cause for Contractor to delay prosecution of the Work if Contractor has been authorized in writing by Public Works Project Manager to proceed.

19. EXTRAS

- A. Without invalidating Contract, Department may order extra work or make changes by altering, adding to or deducting from the Work, contract sum being adjusted in accordance with Article 18 herein.

20. TIME FOR COMPLETION

- A. Contractor agrees that the Work shall be prosecuted regularly and diligently and complete the Work as stated in Construction Documents.

21. CORRECTION OF WORK

- A. All work, all materials whether incorporated in the Work or not, and all processes of manufacture shall at all times and places be subject to inspection of Architect / Engineer and Public Works Project Manager who shall be judge of quality and suitability of the Work, materials, and processes of manufacture for purposes for which they are used. Should they fail to meet Architect / Engineer's and Public Works Project Manager's approval they shall be reconstructed, made good, replaced or corrected, by Contractor at Contractor's expense. Immediately remove all rejected material from site.
- B. If Contractor defaults or neglects to carry out the Work in accordance with Construction Documents or fails to perform any provision of Contract, Department may, after ten (10) business days' written notice to Contractor and without prejudice to any other remedy County may have, make good such deficiencies. In such case, appropriate Change Order shall be issued deducting from Contractor's payments then or thereafter, cost of correcting such deficiencies, including cost of Architect / Engineer's additional services made necessary by such default, neglect or failure.

22. SUBSURFACE CONDITIONS FOUND DIFFERENT

- A. If Contractor encounters subsurface or latent conditions at site materially differing from those shown on Drawings or indicated in Specifications, Contractor shall immediately give notice to Architect / Engineer and Public Works Project Manager of such conditions before they are

disturbed. Architect / Engineer will thereupon promptly investigate conditions, and if Architect / Engineer finds that they materially differ from those shown on Drawings or indicated in Specifications, Architect / Engineer will at once make such changes as necessary, any increase or decrease of cost resulting from such changes to be adjusted in manner provided in above Article 18 entitled "Changes in the Work".

23. RIGHT OF DEPARTMENT TO TERMINATE CONTRACT

- A. In event that any provisions of this Contract are violated by Contractor or by any subcontractors, County may serve written notice upon Contractor and Surety of its intention to terminate Contract, such notice to contain reasons for such intention to terminate Contract, and unless within ten (10) business days after serving of such notice upon Contractor, such violation or delay shall cease and satisfactory arrangement or correction be made, Contract shall, upon expiration of said ten (10) business days, cease and terminate.
- B. In event of any such termination, County shall immediately serve notice thereof upon Surety and Contractor, and Surety shall have right to take over and perform Contract subject to County's approval; provided, however, that if Surety does not commence performance thereof within ten (10) business days from date of mailing to such Surety of notice of termination, County may take over the Work and prosecute same to completion by contract, or by force account, at expense of Contractor; Contractor and Surety shall be liable to County for any excess cost occasioned County thereby, and in such event County may take possession of and utilize in completing the Work, such materials and equipment as may be on the Work site and therefore necessary.

24. CONSTRUCTION SCHEDULE AND PERIODIC ESTIMATES

- A. Contractor shall be responsible for Construction Schedule and coordination. Immediately after execution and delivery of Contract and before making first payment, Contractor shall notify all subcontractors to furnish all required information to develop Construction Schedule. Contractor and all subcontractors associated with the Work shall furnish following information from each Division of Specifications:
 - 1. List of construction activities;
 - 2. Start, finish and time required for completion of each activity;
 - 3. Sequential relationships between activities;
 - 4. Identify all long lead-time items, key events, meetings or activities such as required submittals, fabrication and delivery, procurement of materials, installation and testing;
 - 5. Weekly definition of extent of work and areas of activity for each trade or Subcontract; and
 - 6. Other information as determined by Public Works Project Manager.
- B. In addition to above requested items, Contractor shall request delivery dates for all County-furnished equipment, materials or labor. This shall include any work handled by Department under separate contracts such as asbestos abatement, air and water balancing, etc. Indicate on Construction Schedule these associated delivery and installation dates.
- C. Progress Reporting:
 - 1. Contractor shall update and publish Construction Schedule on monthly basis. Revisions to Schedule shall be by Contractor and made in same detail as original Schedule and accompanied by explanation of reasons for revision; and shall be subject to approval by Department.

2. Failure of Contractor to keep Schedule in updated format shall result in County hiring firm specializing in construction schedule development and deducting those costs associated with updating process from payments due Contractor.
 3. Contractor shall submit show actual percentage of each activity completed, estimated future progress, and anticipated completion time.
- D. Responsibility for timely completion requires:
1. Contractor and subcontractors understand that performance of each is interdependent upon performance of others.
 2. Whenever it becomes apparent from current schedule, that phasing or progress completion dates will not be met, Contractor must take some or all following actions at no additional cost to County:
 - a) Increase construction labor in such quantities and crafts as will eliminate backlog of work.
 - b) Increase number of working hours per shift, shifts per working day, working days per week, amount of construction equipment, or any combination of foregoing to eliminate backlog of work.
 - c) Reschedule work (yet remain in conformance with Drawings and Specifications).
 3. Prior to proceeding with any of above actions, Contractor shall notify Public Works Project Manager.
- E. Maintain current Construction Schedule at all times. Revise Construction Schedule in same detail as original and accompany with explanation of reasons for revision. Schedule shall be subject to approval by Architect / Engineer and Public Works Project Manager.

25. PAYMENTS TO CONTRACTOR

- A. Contractor shall provide:
1. Detailed estimate giving complete breakdown of contract price by Specification Division; and
 2. Periodic itemized estimates of work done for purpose of making partial payments thereon.
- B. Submit these estimates for approval first to Architect / Engineer, then to Public Works Project Manager. Costs employed in making up any of these schedules are for determining basis of partial payments and not considered as fixing basis for additions to or deductions from Contract price.
- C. County will make partial payments to Contractor for value, proportionate to amount of Contract, of all labor and material incorporated in the Work during preceding calendar month upon receipt of Application and Certificate for Payment form from Architect / Engineer and approval of Department.
- D. Contractor shall submit for approval first to Architect / Engineer, and then to Public Works Project Manager all Application and Certificate for Payment forms. If requested, Application and Certificate for Payment shall be supported by such additional evidence as may be required, showing Contractor's right to payment claimed.
- E. Application and Certificate for Payment for preparatory work and materials delivered and suitably stored at site to be incorporated into the Work at some future period, will be given due consideration. Requesting payment for materials stored off site, may be rejected, however, if deemed essential for reasons of job progress, protection, or other sufficient cause, requests will be considered, conditional upon submission by Contractor of bills of sale,

photographs and such other procedures as will adequately protect County's interest such as storage in bonded warehouse with adequate coverage. If there is any error in payment, Contractor is obligated to notify Department immediately, but no longer than ten (10) business days from receipt of payment.

- F. Payments by County will be due within forty-five (45) business days after receipt by Department of Application and Certificate for Payment.
- G. County will retain five percent (5%) of each Application and Certificate for Payment until final completion and acceptance of all the Work covered by Contract. However, anytime after fifty percent (50%) of the Work has been furnished and installed at site, County will make remaining payments in full if Architect / Engineer and Public Works Project Manager find that progress of the Work corresponds with Construction Schedule. If Architect / Engineer and Public Works Project Manager find that progress of the Work does not correspond with Construction Schedule, County may retain up to ten percent (10%) of each Application and Certificate for Payment for the Work completed.
- H. All material and work covered by partial payments made shall become sole property of County, but this provision shall not be construed as relieving Contractor from sole responsibility for care and protection of materials and work upon which payments have been made, or restoration of any damaged work, or as waiver of right of County to require fulfillment of all of terms of Contract.
- I. County will make final payment within sixty (60) calendar days after final completion of the Work, and will constitute acceptance thereof. Submit Equal Benefits Compliance Payment Certification with final pay request. Payment may be denied if Certification is not included.
- J. County may make payment in full, including retained percentages and less authorized deductions, upon completion and acceptance of each Division where price is stated separately in Contract.
- K. Every contractor engaged in performance of any contract for Department of Public Works, Highway & Transportation shall submit to this Department, as requested and with final application for payment for work under said contract, affidavit(s) as required to prove that all debts and claims against this Work are paid in full or otherwise satisfied, and give final evidence of release of all liens against the Work and County. If Wisconsin Prevailing Wage Rate Determination is required for this Work, use "Prime Contractor Affidavit of Compliance with Prevailing Wage Rate Determination" and "Agent or Subcontractor Affidavit of Compliance with Prevailing Wage Rate Determination" (if applicable). If Wisconsin Prevailing Wage Rate Determination is not required for this Work, use "Dane County, Wisconsin Contractor Wage Affidavit". Forms of such affidavits are included in Supplementary Conditions.

26. WITHHOLDING OF PAYMENTS

- A. County, after having served written notice on said Contractor, may either pay directly any unpaid bills of which Department has written notice, or withhold from Contractor's unpaid compensation sum of money deemed reasonably sufficient to pay any and all such lawful claims until satisfactory evidence is furnished that all liabilities have been fully discharged; whereupon, payment to Contractor shall be resumed in accordance with terms of this Contract, but in no event shall these provisions be construed to impose any obligations upon County to either Contractor or Contractor's Surety.

- B. In paying any unpaid bills of Contractor, County shall be deemed agent of Contractor, and any payment so made by County, shall be considered as payment made under Contract by County to Contractor and County shall not be liable to Contractor for any such payment made in good faith.
- C. Contractor shall indemnify, hold harmless and defend Dane County, its boards, commissions, agencies, officers, employees and representatives from all claims growing out of lawful demands of subcontractors, laborers, workers, mechanics, material men, and furnishers of machinery and parts thereof, equipment, power tools, and all supplies, including commissary, incurred in performance of this Contract.
- D. At Department's request, Contractor shall furnish satisfactory evidence that all obligations of nature designated above have been paid, discharged or waived.

27. ACCEPTANCE OF FINAL PAYMENT AS RELEASE

- A. Making of final payment shall constitute waiver of all claims by County except those arising from:
 - 1. Unsettled lien;
 - 2. Faulty or defective work appearing after substantial completion;
 - 3. Failure of the Work to comply with requirements of Construction Documents; or
 - 4. Terms of any special guarantees required by Construction Documents.
- B. Acceptance of final payment shall constitute waiver of all claims by Contractor.

28. PAYMENTS BY CONTRACTOR

- A. Contractor shall pay following not later than fifth (5th) business day following each payment received from County:
 - 1. All transportation and utility services rendered;
 - 2. All materials, tools, and other expendable equipment that have been delivered at site of the Work to extent of ninety percent (90%) of cost thereof, and balance of cost thereof when said balance is paid to Contractor; and
 - 3. Each subcontractor, respective amount allowed Contractor because of work performed by subcontractor to extent of subcontractor's interest therein.

29. CONTRACT SECURITY

- A. Contractor shall furnish Performance and Payment Bonds in amount at least equal to one hundred percent (100%) of Contract price as security for faithful performance of this Contract and payment of all persons performing labor on project under this Contract and furnishing materials in connection with this Contract.
- B. Sample Performance and Payment Bonds that Contractor will be required to execute is bound into these Construction Documents. Before construction Contract is consummated, completed Performance and Payment Bonds must be approved by Department.

30. ASSIGNMENTS

- A. Contractor shall not assign whole or any part of this Contract or any moneys due or to become due hereunder without written consent of Department. In case Contractor assigns all or any part of any moneys due or to become due under this Contract, instrument of

assignment shall contain clause substantially to effect that it is agreed that right of assignee in and to any moneys due or to become due to Contractor shall be subject to prior claims of all persons, firms and corporations for services rendered or materials supplied for performance of the Work called for in this Contract.

31. MUTUAL RESPONSIBILITY OF CONTRACTORS

- A. If, through acts of neglect on part of Contractor or any subcontractor shall suffer loss or damage on the Work, Contractor agrees to settle with such subcontractor by agreement or arbitration if such other subcontractor will so settle. If such subcontractor shall assert any claim against County on account of any damage alleged to have been sustained, Department shall notify Contractor, who shall indemnify, hold harmless and defend Dane County, its boards, commissions, agencies, officers, employees and representatives against any such claim.

32. SEPARATE CONTRACTS

- A. Department may award other contracts for the Work and all Contractors shall fully cooperate with each other and carefully adjust their work to that provided under other contracts as may be directed by Department. No Contractor shall commit or permit any act that will interfere with performance of the Work by any other Contractor.
- B. Contractor shall coordinate the Work with those of other Contractors. Cooperation will be required in arrangement for storage of materials and in detailed execution of the Work. Contractor, including subcontractors, shall keep informed of progress and detail work of others and shall notify Architect / Engineer or Department immediately of lack of progress or defective workmanship on part of others. Failure of Contractor to keep informed of the Work progressing on site and failure to give notice of lack of progress or defective workmanship by others shall be construed as acceptance by Contractor of status of the Work as being satisfactory for proper coordination with Contractor's own work.

33. SUBCONTRACTS

- A. Contractor may use services of specialty subcontractors on those parts of the Work that, under normal contracting practices, are performed by specialty subcontractors.
- B. Contractor shall not award any work to any subcontractor without prior approval of Department. Qualifications of subcontractors shall be same as qualifications of Contractor. Request for subcontractor approval shall be submitted to Department fifteen (15) business days before start of subcontractor's work. If subcontractors are changed or added, Contractor shall notify Department in writing.
- C. Contractor shall be as fully responsible to County for acts and omissions of subcontractors, and of persons either directly or indirectly employed by them, as Contractor is for acts and omissions of persons directly employed by Contractor.
- D. Contractor shall cause appropriate provisions to be inserted in all subcontracts relative to the Work to bind subcontractors to Contractor by terms of General Conditions of Contract and other Construction Documents insofar as applicable to work of subcontractors and to give Contractor same power as regards terminating any subcontract that Department may exercise over Contractor under any provision of Construction Documents.

- E. Nothing contained in this Contract shall create any contractual relation between any subcontractor and County.
- F. Contractor shall insert in all subcontracts, Articles 26, 33, 43 and 45, respectively entitled: “Withholding of Payments”, “Subcontracts”, “Affirmative Action Provision and Minority / Women / Disadvantaged Business Enterprises”, and “Minimum Wages”, and shall further require all subcontractors to incorporate physically these same Articles in all subcontracts.

34. PUBLIC WORKS PROJECT MANAGER’S AUTHORITY

- A. Public Works Project Manager shall:
 - 1. Administer and ensure compliance with Construction Documents;
 - 2. Provide responsible on-site observations of construction and have authority to request work and to stop work whenever necessary to insure proper enforcement of Construction Documents;
 - 3. Convene and chair project meetings and foreman’s coordination meetings when necessary to coordinate resolution of conflicts between Contractors, Architects, Engineers, Consultants, and Department; and
 - 4. Check and inspect material, equipment and installation procedures of all trades for proper workmanship and for compliance with Drawings, Specifications and Shop Drawings, permit no material on project site that is not satisfactory and reject work not in compliance with Construction Documents.

35. ARCHITECT / ENGINEER’S AUTHORITY

- A. Architect / Engineer is retained by, and is responsible to Department acting for County.
- B. Architect / Engineer shall determine amount, quality, acceptability, and fitness of several kinds of work and materials that are provided under this Contract and shall decide all questions that may arise in relation to said work and construction thereof.
- C. Architect / Engineer shall decide meaning and intent of any portion of Specifications and of any Drawings where they may be found obscure or be in dispute.
- D. Architect / Engineer shall provide responsible observation of construction. Architect / Engineer has authority to stop the Work whenever such stoppage may be necessary to insure proper execution of Construction Documents.
- E. Architect / Engineer shall be interpreter of conditions of Construction Documents and judge of its performance.
- F. Within reasonable time, Architect / Engineer shall make decisions on all matters relating to progress of the Work or interpretation of Construction Documents.
- G. Architect / Engineer’s decisions are subject to review by Public Works Project Manager.

36. STATED ALLOWANCES

- A. Stated allowances enumerated in Instructions to Bidders shall cover net cost of materials or equipment, and all applicable taxes. Contractor’s cost of delivery and unloading at site, handling costs on site, labor, installation costs, overhead, profit and any other incidental costs shall be included in Contractor’s bid, but not as part of cash allowance.

- B. Department will solicit at least two (2) bids on materials or equipment for which allowance is stated and select on basis of lowest qualified responsible bid. Contractor will then be instructed to purchase “Allowed Materials”. If actual price for purchasing “Allowed Materials”, including taxes, is more or less than “Cash Allowance”, Contract price shall be adjusted accordingly. Adjustment in Contract price shall not contain any cost items excluded from cash allowance.

37. ESTIMATES OF QUANTITIES

- A. Whenever estimated quantities of work to be done and materials to be furnished under this Contract are shown in any of Construction Documents, they are given for use in comparing bids and right is especially reserved to increase or diminish them as they may be deemed reasonably necessary or desirable by Department to complete the Work included in this Contract, and cost for such increase or diminution shall be adjusted in manner provided for in General Conditions of Contract Article 18 entitled “Changes in the Work”.

38. LANDS AND RIGHTS-OF-WAY

- A. Prior to start of construction, County shall furnish all land and rights-of-way necessary for carrying out and completion of the Work to be performed under this Contract.

39. GENERAL GUARANTEE

- A. Neither final certificate of payment nor any provision in Construction Documents nor partial or entire occupancy of premises by County shall constitute acceptance of work not done in accordance with Construction Documents or relieve Contractor of liability in respect to any expressed warranties or responsibility for faulty materials or workmanship.
 - 1. In no event shall making of any payment required by Contract constitute or be construed as waiver by County of any breach of covenants of Contract or waiver of any default of Contractor and making of any such payment by County while any such default or breach shall exist shall in no way impair or prejudice right of County with respect to recovery of damages or other remedy as result of such breach or default.
- B. Contractor shall remedy and make good all defective workmanship and materials and pay for any damage to other work resulting there from, which appear within period of one (1) year from date of substantial completion, providing such defects are not clearly due to abuse or misuse by County. Department will give notice of observed defects with reasonable promptness.
- C. Guarantee on work executed after certified date of substantial completion will begin on date when such work is inspected and approved by Architect / Engineer and Public Works Project Manager.
- D. Where guarantees or warranties are required in sections of Specifications for periods in excess of one (1) year, such longer terms shall apply; however, Contractor’s Performance and Payment Bonds shall not apply to any guarantee or warranty period in excess of one (1) year.

40. CONFLICTING CONDITIONS

- A. Any provision in any of Construction Documents which may be in conflict or inconsistent with any Articles in these General Conditions of Contract or Supplementary Conditions shall be void to extent of such conflict or inconsistency.
- B. In case of ambiguity or conflict between Drawings and Specifications, Specifications shall govern.
- C. Printed dimensions shall be followed in preference to measurements by scale. Large-scale drawings take precedence over small-scale drawings. Dimensions on Drawings and details are subject to field measurements of adjacent work.

41. NOTICE AND SERVICE THEREOF

- A. Any notice to Contractor from Department relative to any part of this Contract shall be in writing and considered delivered and service thereof completed, when said notice is posted, by certified or registered mail, to Contractor at Contractor's last given address, or delivered in person to said Contractor, or Contractor's authorized representative on the Work.

42. PROTECTION OF LIVES AND HEALTH

- A. In order to protect lives and health of Contractor's employees under Contract, Contractor shall comply with all pertinent provisions of Wisconsin Administrative Code, Rules of Department of Commerce, relating to Safety and Health.
- B. Contractor alone shall be responsible for safety, efficiency and adequacy of Contractor's tools, equipment and methods, and for any damage that may result from their failure or their improper construction, maintenance or operation.

43. AFFIRMATIVE ACTION PROVISION AND MINORITY / WOMEN / DISADVANTAGED BUSINESS ENTERPRISES

- A. Affirmative Action Provisions.
 - 1. During term of their Contract, Contractor agrees not to discriminate on basis of race, religion, color, sex, handicap, age, sexual preference, marital status, physical appearance, or national origin against any person, whether recipient of services (actual or potential), employee, or applicant for employment. Such equal opportunity shall include but not be limited to following: employment, upgrading, demotion, transfer, recruitment, advertising, layoff, termination, training, rates of pay, and any other form of compensation or level of service(s). Contractor agrees to post in conspicuous places, these affirmative action standards so as to be visible to all employees, service recipients and applicants for this paragraph. Listing of prohibited bases for discrimination shall not be construed to amend in any fashion state or federal law setting forth additional bases and exceptions shall be permitted only to extent allowable in state or federal law.
 - 2. Contractor is subject to this Article only if Contractor has ten (10) or more employees and receives \$10,000.00 or more in annual aggregate contracts with County. Contractor shall file and Affirmative Action Plan with Dane County Contract Compliance Officer in accord with Chapter 19 of Dane County Code of Ordinances. Such plan must be filed within fifteen (15) business days of effective date of this Contract and failure to do so by said date shall constitute ground for immediate termination of Contract by County. Contractor shall also, during term of this Contract, provide copies of all announcements of employment opportunities to County's Contract Compliance Office, and shall report

- annually number of persons, by race, sex and handicap status, who apply for employment, and, similarly classified, number hired and number rejected.
3. Contact Dane County Contract Compliance Officer at Dane County Contract Compliance Office, 210 Martin Luther King, Jr. Blvd., Room 421, Madison, WI 53703, 608/266-4114.
 4. In all solicitations for employment placed on Contractor's behalf during term of this Contract, Contractor shall include statement to affect Contractor is "Equal Opportunity Employer". Contractor agrees to furnish all information and reports required by County's Contract Compliance Officer as same relate to affirmative action and nondiscrimination, which may include any books, records, or accounts deemed appropriate to determine compliance with Chapter 19, Dane County Code of Ordinances, and provision of this Contract.

B. Minority / Women / Disadvantaged / Emerging Small Business Enterprises.

1. Chapter 19.508 of Dane County Code of Ordinances is official policy of Dane County regarding utilization of, to fullest extent of, Minority Business Enterprises (MBEs), Women Business Enterprises (WBEs) Disadvantage Business Enterprises (DBEs) and Emerging Small Business Enterprises (ESBEs).
2. Contractor may utilize MBEs / WBEs / DBEs / ESBEs as subcontractors or suppliers. List of subcontractors will be required of low bidder as stated in this Contract. List shall indicate which are MBEs / WBEs / DBEs / ESBEs and percentage of subcontract awarded, shown as percentage of total dollar amount of bid.

44. COMPLIANCE WITH FAIR LABOR STANDARDS

- A. During term of this Contract, Contractor shall report to County Contract Compliance Officer, within ten (10) business days, any allegations to, or findings by National Labor Relations Board (NLRB) or Wisconsin Employment Relations Commission (WERC) that Contractor has violated statute or regulation regarding labor standards or relations. If investigation by Contract Compliance Officer results in final determination that matter adversely affects Contractor's responsibilities under this Contract, and which recommends termination, suspension or cancellation of this Contract, County may take such action.
- B. Contractor may appeal any adverse finding by Contract Compliance Officer as set forth in Dane County Ordinance 25.015(11)(c) through (e).
- C. Contractor shall post this statement in prominent place visible to employees: "As condition of receiving and maintaining contract with Dane County, this employer shall comply with federal, state and all other applicable laws prohibiting retaliation or union organizing."

45. DOMESTIC PARTNERSHIP BENEFITS

- A. Contractor agrees to provide same economic benefits to all of its employees with domestic partners as it does to employees with spouses, or cash equivalent if such benefit cannot reasonably be provided. Contractor agrees to make available for County inspection Contractor's payroll records relating to employees providing services on or under this Contract or subcontract. If any payroll records of Contractor contain any false, misleading or fraudulent information, or if Contractor fails to comply with provisions of Chapter 25.016, Dane County Ordinances, contract compliance officer may withhold payments on Contract; terminate, cancel or suspend Contract in whole or in part; or, after due process hearing, deny Contractor right to participate in bidding on future County contracts for period of one year after first violation is found and for period of three years after second or subsequent violation is found.

46. USE AND OCCUPANCY PRIOR TO ACCEPTANCE

- A. Contractor agrees to use and occupancy of portion or unit of the Work before formal acceptance by Department, provided Department:
 - 1. Secures written consent of Contractor; except when in opinion of Public Works Project Manager, Contractor is chargeable with unwarranted delay in final cleanup of punch list items or other Contract requirements.
 - 2. Secures endorsement from insurance carrier and consent of Surety permitting occupancy of building or use of the Work during remaining period of construction, or, secures consent of Surety.
 - 3. Assumes all costs and maintenance of heat, electricity and water.
 - 4. Accepts all work completed within that portion or unit of the Work to be occupied, at time of occupancy.

47. MINIMUM WAGES

- A. Contractor shall post, at appropriate conspicuous point on site of project, schedule showing all determined minimum wage rates for various classes of laborers and mechanics to be engaged in the Work under this Contract and all deductions, if any, required by law to be made from unpaid wages actually earned by laborers and mechanics so engaged.
- B. Supplementary Conditions section in Construction Documents lists wage determinations required by State Law.
- C. If, after award of Contract, it becomes necessary to employ any person in trade or occupation not classified in wage determinations, such person shall be paid at not less than such rate as shall be determined by Wisconsin Department of Workforce Development. Such approved minimum rate shall be retroactive to time of initial employment of such person in such trade or occupation. Contractor shall notify Department of Contractor's intention to employ persons in trades or occupations not so classified in sufficient time for Department to obtain approved rates for such trades or occupations.
- D. Specified wage rates are minimum rates only, and Department will not consider any claims for additional compensation made by Contractor because of payment by Contractor of any wage rate in excess of applicable rate contained in this Contract. Contractor shall adjust any disputes in regard to payment of wages in excess of those specified in this Contract.
- E. Submit required affidavit(s) to Department of Public Works, Highway & Transportation, as requested and with final application for payment for work under said contract. Affidavit(s) shall clearly indicate name, trade or occupation, and paid wages of every laborer, worker or mechanic employed by Contractor and all subcontractors during billing period including accurate record of number of hours worked by each employee and actual wages paid as stipulated in Wisconsin Statute 66.0903. If Wisconsin Prevailing Wage Rate Determination is required for this Work, use "Prime Contractor Affidavit of Compliance with Prevailing Wage Rate Determination" and "Agent or Subcontractor Affidavit of Compliance with Prevailing Wage Rate Determination" (if applicable). If Wisconsin Prevailing Wage Rate Determination is not required for this Work, use "Dane County, Wisconsin Contractor Wage Affidavit". Forms of such affidavits are included in Supplementary Conditions.

48. CLAIMS

- A. No claim may be made until Department's Assistant Public Works Director has reviewed Architect / Engineer's decision as provided for in Article 35 of General Conditions of Contract. If any claim remains unresolved after such review by Department's Assistant Public Works Director the claim may be filed under Wisconsin Statute 893.80. Work shall progress during period of any dispute or claim. Unless specifically agreed between parties, venue will be in Dane County, Wisconsin.

49. ANTITRUST AGREEMENT

- A. Contractor and County recognize that in actual economic practice, overcharges resulting from antitrust violations are in fact usually borne by County. Therefore, Contractor hereby assigns to County any and all claims for such overcharges as to goods and materials purchased in connection with this Contract, except as to overcharges which result from antitrust violations commencing after price is established under this Contract and any change order thereto.

50. INSURANCE

- A. Contractor Carried Insurance:
 - 1. Contractor shall not commence work under this Contract until Contractor has obtained all insurance required under this Article and has provided evidence of such insurance to Risk Manager, 425 City-County Building, 210 Martin Luther King Jr. Blvd., Madison, WI 53703. Contractor shall not allow any subcontractor to commence work until insurance required of subcontractor has been so obtained and approved. Company providing insurance must be licensed to do business in Wisconsin.
 - 2. Worker's Compensation Insurance:
 - a) Contractor shall procure and shall maintain during life of this Contract, Worker's Compensation Insurance as required by statute for all of Contractor's employees engaged in work at site of project under this Contract and, in case of any such work sublet, Contractor shall require subcontractor similarly to provide Worker's Compensation Insurance for all of latter's employees to be engaged in such work unless such employees are covered by protection afforded by Contractor's Worker's Compensation Insurance.
 - b) If any claim of employees engaged in hazardous work on project under this Contract is not protected under Worker's Compensation Statute, Contractor shall provide and shall cause each subcontractor to provide adequate Employer's Liability Insurance for protection of such of Contractor's employees as are not otherwise protected.
 - 3. Contractor's Public Liability and Property Damage Insurance:
 - a) Contractor shall procure and maintain during life of this Contract, Contractor's Public Liability Insurance and Contractor's Property Damage Insurance in amount not less than \$1,000,000 bodily injury, including accidental death, to any one person, and subject to same limit for each person, in amount not less than \$1,000,000 on account of one accident, and Contractor's Property Damage Insurance in amount not less than \$1,000,000 or combined single limit of at least \$1,000,000 with excess coverage over and above general liability in amount not less than \$5,000,000. Contractor shall add "Dane County" as additional insured for each project.
 - b) Contractor's Public Liability and Property Damage Insurance shall include Products, Completed Operation, and Contractual Liability under Insurance Contract. "Contractor shall in all instances save, defend, indemnify and hold harmless County and Architect / Engineer against all claims, demands, liabilities, damages or any other costs which may accrue in prosecution of the Work and that Contractor will save, defend, indemnify and hold harmless County and Architect / Engineer from all

damages caused by or as result of Contractor's operations" and each shall be listed as additional insured on Contractor's and sub-contractors' insurance policies.

- c) Obligations of Contractor under Article 50.A.2.b) shall not extend to liability of Architect / Engineer, agents or employees thereof, arising out of:
 - 1) Preparation or approval of maps, drawings, opinions, reports, surveys, change orders, designs or specifications; or
 - 2) Giving of or failure to give directions or instructions by Architect / Engineer, agents or employees thereof provided such giving or failure to give is primary cause of injury or damage.
- d) Contractor shall procure and shall maintain during life of this Contract, Comprehensive Automobile Liability Insurance covering owned, non-owned and hired automobiles for limits of not less than \$1,000,000 each accident single limit, bodily injury and property damage combined with excess coverage over and above general liability in amount not less than \$5,000,000.
- e) Contractor shall either:
 - 1) Require each subcontractor to procure and to maintain during life of subcontract, subcontractor's Public Liability Property Damage Insurance, and Comprehensive Automobile Liability Insurance of type and in same amount specified in preceding paragraphs; or
 - 2) Insure activities of subcontractors in Contractor's own policy.
- 4. Scope of Insurance and Special Hazards: Insurance required under Article 50.A.2 & 50.A.3. hereof shall provide adequate protection for Contractor and subcontractors, respectively, against damage claims which may arise from operations under this Contract, whether such operation be by insured or by anyone directly or indirectly employed by insured and also against any of special hazards which may be encountered in performance of this Contract as enumerated in Supplementary Conditions.
- 5. Proof of Carriage of Insurance: Contractor shall furnish Risk Manager with certificates showing type, amount, class of operations covered, effective dates, dates of expiration of policies and "Dane County" listed as additional insured. Such certificates shall also contain (substantially) following statement: "Insurance covered by this certificate will not be canceled or materially altered, except after ten (10) business days written notice has been received by Risk Manager."

B. Builder's Risk:

- 1. County shall provide Builder's Risk insurance coverage for its insurable interests in construction or renovation projects with completed value of \$500,000 or less. Therefore, if project completed value is more than \$500,000, Contractor shall obtain and maintain in force, at its own expense, Builder's Risk Insurance on all risks for amount equal to full completed value of covered structure or replacement value of alterations or additions. Any deductible shall not exceed \$25,000 for each loss. Policy shall include occupancy clause and list Dane County as loss payee.

C. Indemnification / Hold Harmless:

- 1. Contractor shall indemnify, hold harmless and defend Dane County, its boards, commissions, agencies, officers, employees and representatives from and against all claims, damages, losses and expenses including attorneys' fees arising out of or resulting from performance of the Work, provided that any such claim, damage, loss or expense is attributable to bodily injury, sickness, disease or death, or to injury to or destruction of tangible property (other than the Work itself) including loss of use resulting therefrom, and is caused in whole or in part by any act or omission of Contractor, any subcontractor, anyone directly or indirectly employed by any of them or anyone for whose acts any of them may be liable, regardless of whether or not it is caused in part by part indemnified hereunder.

2. In any and all claims against Dane County, its boards, commissions, agencies, officers, employees and representatives or by any employee of Contractor, any subcontractor, anyone directly or indirectly employed by any of them or anyone for whose acts any of them may be liable, indemnification obligation under this Contract shall not be limited in any way by any limitation on amount or type of damages, compensation or benefits payable by or for Contractor or any subcontractor under worker's compensation acts, disability benefits or other employee benefit acts.
3. Obligations of Contractor under this Contract shall not extend to liability of Architect / Engineer, its agents or employees arising out of:
 - a) Preparation or approval of maps, drawings, opinion, reports, surveys, change orders, designs or specifications; or
 - b) Giving of or failure to give directions or instruction by Architect / Engineer, its agents or employees provided such giving or failure to give is primary cause of injury or damage.
4. Dane County shall not be liable to Contractor for damages or delays resulting from work by third parties or by injunctions or other restraining orders obtained by third parties.

51. WISCONSIN LAW CONTROLLING

- A. It is expressly understood and agreed to by parties hereto that in event of any disagreement or controversy between parties, Wisconsin law shall be controlling.

SUPPLEMENTARY CONDITIONS

1. APPLICATION & CERTIFICATE FOR PAYMENT

- A. Every contractor engaged in performance of any contract for Department of Public Works, Highway & Transportation shall submit partial and final Application & Certificate for Payment for work under said contract. Form shall provide similar information as shown on AIA G702™ and G703™ forms (samples shown below). Forms shall be submitted to Public Works Project Manager for approval.

AIA Document G702™ – 1992

Application and Certificate for Payment

TO OWNER:	PROJECT:	APPLICATION NO:	Distribution to:
FROM CONTRACTOR:	VIA ARCHITECT:	PERIOD TO:	OWNER <input type="checkbox"/>
		CONTRACT FOR:	ARCHITECT <input type="checkbox"/>
		CONTRACT DATE:	CONTRACTOR <input type="checkbox"/>
		PROJECT NOS:	FIELD <input type="checkbox"/>
			OTHER <input type="checkbox"/>

CONTRACTOR'S APPLICATION FOR PAYMENT

Application is made for payment, as shown below, in connection with the Contract. AIA Document G703™, Continuation Sheet, is attached.

1. ORIGINAL CONTRACT SUM \$ _____

2. NET CHANGE BY CHANGE ORDERS \$ _____

3. CONTRACT SUM TO DATE (Line 1 + 2) \$ _____

4. TOTAL COMPLETED & STORED TO DATE (Column G on G703) \$ _____

5. RETAINAGE:

a. _____ % of Completed Work
(Columns D + E on G703) \$ _____

b. _____ % of Stored Material
(Column F on G703) \$ _____

Total Retainage (Lines 5a + 5b, or Total in Column I of G703) \$ _____

6. TOTAL EARNED LESS RETAINAGE \$ _____
(Line 4 minus Line 5 Total)

7. LESS PREVIOUS CERTIFICATES FOR PAYMENT \$ _____
(Line 6 from prior Certificate)

8. CURRENT PAYMENT DUE \$ _____

9. BALANCE TO FINISH, INCLUDING RETAINAGE \$ _____
(Line 3 minus Line 6)

The undersigned Contractor certifies that to the best of the Contractor's knowledge, information and belief the Work covered by this Application for Payment has been completed in accordance with the Contract Documents, that all amounts have been paid by the Contractor for Work for which previous Certificates for Payment were issued and payments received from the Owner, and that current payment shown herein is now due.

CONTRACTOR:
By: _____ Date: _____
State of: _____
County of: _____
Subscribed and sworn to before me this _____ day of _____

Notary Public:
My commission expires: _____

CHANGE ORDER SUMMARY	ADDITIONS	DEDUCTIONS
Total changes approved in previous months by Owner	\$ _____	\$ _____
Total approved this month	\$ _____	\$ _____
TOTAL	\$ _____	\$ _____
NET CHANGES by Change Order	\$ _____	

ARCHITECT'S CERTIFICATE FOR PAYMENT

In accordance with the Contract Documents, based on on-site observations and the data comprising this application, the Architect certifies to the Owner that to the best of the Architect's knowledge, information and belief the Work has progressed as indicated, the quality of the Work is in accordance with the Contract Documents, and the Contractor is entitled to payment of the AMOUNT CERTIFIED.

AMOUNT CERTIFIED \$ _____
(Attach explanation if amount certified differs from the amount applied. Initial all figures on this Application and on the Continuation Sheet that are changed to conform with the amount certified.)

ARCHITECT:
By: _____ Date: _____

This Certificate is not negotiable. The AMOUNT CERTIFIED is payable only to the Contractor named herein. Issuance, payment and acceptance of payment are without prejudice to any rights of the Owner or Contractor under this Contract.

CAUTION: You should sign an original AIA Contract Document, on which this text appears in RED. An original assures that changes will not be obscured.
 AIA Document G702™ – 1992, Copyright © 1963, 1963, 1965, 1971, 1978, 1983 and 1992 by The American Institute of Architects. All rights reserved. WARNING: This AIA® Document is protected by U.S. Copyright Law and International Treaties. Unauthorized reproduction or distribution of this AIA® Document, or any portion of it, may result in severe civil and criminal penalties, and will be prosecuted to the maximum extent possible under the law. Purchasers are permitted to reproduce ten (10) copies of this document when completed. To report copyright violations of AIA Contract Documents, e-mail The American Institute of Architects' legal counsel, copyright@aia.org.

AIA Document G703™ – 1992

Continuation Sheet

AIA Document G702™-1992, Application and Certificate for Payment, or G732™-2009, Application and Certificate for Payment, Construction Manager as Adviser Edition, containing Contractor's signed certification is attached. In tabulations below, amounts are in US dollars. Use Column I on Contracts where variable retainage for line items may apply.

APPLICATION NO:
APPLICATION DATE:
PERIOD TO:
ARCHITECT'S PROJECT NO:

A ITEM NO.	B DESCRIPTION OF WORK	C SCHEDULED VALUE	D WORK COMPLETED		F MATERIALS PRESENTLY STORED <i>(Not in D or E)</i>	G TOTAL COMPLETED AND STORED TO DATE <i>(D+E-F)</i>	H BALANCE TO FINISH <i>(C-G)</i>	I RETAINAGE <i>(if variable rate)</i>
			D FROM PREVIOUS APPLICATION <i>(D-E)</i>	E THIS PERIOD				
<p>CAUTION: You should sign an original AIA Contract Document, on which this text appears in RED. An original assures that changes will not be obscured.</p> <p>AIA Document G703™ – 1992. Copyright © 1963, 1965, 1966, 1967, 1970, 1978, 1983 and 1992 by The American Institute of Architects. All rights reserved. WARNING: This AIA® Document is protected by U.S. Copyright Law and International Treaties. Unauthorized reproduction or distribution of this AIA® Document, or any portion of it, may result in severe civil and criminal penalties, and will be prosecuted to the maximum extent possible under the law. Purchasers are permitted to reproduce ten (10) copies of this document when completed. To report copyright violations of AIA Contract Documents, e-mail The American Institute of Architects' legal counsel, copyright@aia.org.</p>								
<p>10-1204504</p>								

2. PREVAILING WAGE RATE DETERMINATION

- A. A prevailing wage rate determination (PWRD) may be required on this project depending on the total project cost. A PWRD is not required if the total bid is below \$100,000. If the bid is \$100,000 or more, the Contractor shall apply the PWRD. The PWRD shall also be applied if the bid is a single trade project for \$48,000 or more. A single trade project is one in which no single trade accounts for eighty-five percent (85%) or more of the total labor cost of the project.
- B. These supplements shall modify, delete, and / or add to General Conditions of Contract. Where any article, paragraph, or subparagraph in General Conditions of Contract is supplemented by one of these paragraphs, provisions of such article, paragraph, or subparagraph shall remain in effect and supplementary provisions shall be considered as added thereto. Where any article, paragraph, or subparagraph in General Conditions of Contract is amended, voided, or superseded by any of these paragraphs, provisions of such article, paragraph, or subparagraph not so amended, voided, or superseded shall remain in effect.
 - 1. General Conditions of Contract Article 47, "Minimum Wages", paragraph B. Following Prevailing Wage Rate Determination No. 201601747 is added to General Conditions of Contract.
- C. These State of Wisconsin forms, hereinafter set forth in this section, shall be filled out and submitted to Department of Public Works, Highway & Transportation:
 - 1. Disclosure of Ownership (ERD-7777)
 - 2. Prime Contractor Affidavit of Compliance With Prevailing Wage Rate Determination (ERD-5724)
 - 3. List of Agents and Subcontractors (Page 2 - ERD-5724)
 - 4. Agent or Subcontractor Affidavit of Compliance With Prevailing Wage Rate Determination (ERD-10584)
 - 5. List of Agents and Subcontractors (Page 2 - ERD-10584)
 - 6. Request To Employ Subjourneyperson (ERD-10880)
- D. At a minimum, these wage rates must be displayed in a place where all workers can access them, but not inside the job trailer. If this isn't easily done based on job conditions, the State requires they be displayed at a library or other public building.

State of Wisconsin Department of Workforce Development Equal Rights Division	DEPARTMENTAL ORDER
ISSUE DATE: 6/6/2016	
PROJECT:	
COUNTY HIGHWAY FACILITY SATELLITE BUILDING YORK TOWN, DANE COUNTY, WI Determination No. 201601747 [Owner Project No. 316014]	
PROJECT OWNER:	REQUESTER:
RYAN SHORE, PROJECT MANAGER DANE COUNTY PUBLIC WORKS 1919 ALLIANT ENERGY CENTER WAY MADISON, WI 53713	RYAN SHORE, PROJECT MANAGER DANE COUNTY PUBLIC WORKS 1919 ALLIANT ENERGY CENTER WAY MADISON, WI 53713
ADDITIONAL CONTACT:	NOTE: The Requester must provide a copy of this Project Determination and enclosures to the Project Owner and Additional Contact.
<p>The department received an application for prevailing wage rate determination for the above-captioned project. The department conducted a survey to determine the prevailing wage rate for the trade(s) or occupation(s) needed to complete the project. The survey's findings appear in the attached project determination.</p> <p>If you believe that the wage rate for any trade or occupation does not accurately reflect the prevailing wage rate in the city, village or town where the project is located, you may ask the department to conduct an administrative review of such wage rate. You must submit this request in writing within 30 days from the date indicated above. Additionally, your request must include wage rate information from at least three similar projects in the city, village or town where the proposed project is located and on which some work has been performed by the contested trade(s) during the current survey period and was previously considered by the department in issuing the attached determination. See DWD 290.10 of the Wisconsin Administrative Code and either s. 66.0903(3)(br), Stats., or s. 103.49(3)(c), Stats., for a complete explanation of the administrative review process.</p> <p>Enclosures</p>	
<p>It is hereby ordered that the prevailing wage rates set forth in the attached project determination shall only be applicable to the above referenced project. This order is a FINAL ORDER of the department unless a timely request for an administrative review is filed with the department.</p> <p>ISSUED BY:</p> <p style="text-align: center;"> Equal Rights Division Labor Standards Bureau Construction Wage Standards Section P.O. Box 8928, Madison, WI 53708-8928 (608)266-6861 </p> <p style="text-align: center;"> Web Site: http://dwd.wisconsin.gov/er/ </p>	

PREVAILING WAGE RATE DETERMINATION

Issued by the State of Wisconsin
Department of Workforce Development
Pursuant to s. 66.0903, Wis. Stats.
Issued On: 6/6/2016

DETERMINATION NUMBER: 201601747

EXPIRATION DATE: Prime Contracts MUST Be Awarded or Negotiated On Or Before 12/31/2016. If NOT, You MUST Reapply.

PROJECT NAME: COUNTY HIGHWAY FACILITY SATELLITE BUILDING
PROJECT NO: 316014

PROJECT LOCATION: YORK TOWN, DANE COUNTY, WI

CONTRACTING AGENCY: DANE COUNTY PUBLIC WORKS

CLASSIFICATION:	Contractors are responsible for correctly classifying their workers. Either call the Department of Workforce Development (DWD) with trade or classification questions or consult DWD's Dictionary of Occupational Classifications & Work Descriptions on the DWD website at: dwd.wisconsin.gov/er/prevailing_wage_rate/Dictionary/dictionary_main.htm .
OVERTIME:	Time and one-half must be paid for all hours worked: <ul style="list-style-type: none">- over 10 hours per day on prevailing wage projects- over 40 hours per calendar week- Saturday and Sunday- on all of the following holidays: January 1; the last Monday in May; July 4; the 1st Monday in September; the 4th Thursday in November; December 25;- The day before if January 1, July 4 or December 25 falls on a Saturday;- The day following if January 1, July 4 or December 25 falls on a Sunday. Apply the time and one-half overtime calculation to whichever is higher between the Hourly Basic Rate listed on this project determination or the employee's regular hourly rate of pay. Add any applicable Premium or DOT Premium to the Hourly Basic Rate before calculating overtime. A DOT Premium (discussed below) may supersede this time and one-half requirement.
FUTURE INCREASE:	When a specific trade or occupation requires a future increase, you MUST add the full hourly increase to the "TOTAL" on the effective date(s) indicated for the specific trade or occupation.
PREMIUM PAY:	If indicated for a specific trade or occupation, the full amount of such pay MUST be added to the "HOURLY BASIC RATE OF PAY" indicated for such trade or occupation, whenever such pay is applicable.
DOT PREMIUM:	This premium only applies to highway and bridge projects owned by the Wisconsin Department of Transportation and to the project type heading "Airport Pavement or State Highway Construction." DO NOT apply the premium calculation under any other project type on this determination.
APPRENTICES:	Pay apprentices a percentage of the applicable journey person's hourly basic rate of pay and hourly fringe benefit contributions specified in this determination. Obtain the appropriate percentage from each apprentice's contract or indenture.
SUBJOURNEY:	Subjourney wage rates may be available for some of the trades or occupations indicated below with the exception of laborers, truck drivers and heavy equipment operators. Any employer interested in using a subjourney classification on this project MUST complete Form ERD-10880 and request the applicable wage rate from the Department of Workforce Development PRIOR to using the subjourney worker on this project.

This document **MUST BE POSTED** by the **CONTRACTING AGENCY** in at least one conspicuous and easily accessible place **on the site of the project**. A local governmental unit may post this document at the place normally used to post public notices if there is no common site on the project. This document **MUST** remain posted during the entire time any worker is employed on the project and **MUST** be physically incorporated into the specifications and all contracts and subcontracts. If you have any questions, please write to the Equal Rights Division, Labor Standards Bureau, P.O. Box 8928, Madison, Wisconsin 53708 or call (608) 266-6861.

The following statutory provisions apply to local governmental unit projects of public works and are set forth below pursuant to the requirements of s. 66.0903(8), Stats.

s. 66.0903 (1) (f) & s. 103.49 (1) (c) "PREVAILING HOURS OF LABOR" for any trade or occupation in any area means 10 hours per day and 40 hours per week and may not include any hours worked on a Saturday or Sunday or on any of the following holidays:

1. January 1.
2. The last Monday in May.
3. July 4.
4. The first Monday in September.
5. The 4th Thursday in November.
6. December 25.
7. The day before if January 1, July 4 or December 25 falls on a Saturday.
8. The day following if January 1, July 4 or December 25 falls on a Sunday.

s. 66.0903 (10) RECORDS; INSPECTION; ENFORCEMENT.

(a) Each contractor, subcontractor, or contractor's or subcontractor's agent performing work on a project of public works that is subject to this section shall keep full and accurate records clearly indicating the name and trade or occupation of every person performing the work described in sub. (4) and an accurate record of the number of hours worked by each of those persons and the actual wages paid for the hours worked.

s. 66.0903 (11) LIABILITY AND PENALTIES.

(a) 1. Any contractor, subcontractor, or contractor's or subcontractor's agent who fails to pay the prevailing wage rate determined by the department under sub. (3) or who pays less than 1.5 times the hourly basic rate of pay for all hours worked in excess of the prevailing hours of labor is liable to any affected employee in the amount of his or her unpaid wages or his or her unpaid overtime compensation and in an additional amount as liquidated damages as provided under subd. 2., 3., whichever is applicable.

2. If the department determines upon inspection under sub. (10) (b) or (c) that a contractor, subcontractor, or contractor's or subcontractor's agent has failed to pay the prevailing wage rate determined by the department under sub. (3) or has paid less than 1.5 times the hourly basic rate of pay for all hours worked in excess of the prevailing hours of labor, the department shall order the contractor to pay to any affected employee the amount of his or her unpaid wages or his or her unpaid overtime compensation and an additional amount equal to 100 percent of the amount of those unpaid wages or that unpaid overtime compensation as liquidated damages within a period specified by the department in the order.

3. In addition to or in lieu of recovering the liability specified in subd. 1. as provided in subd. 2., any employee for and in behalf of that employee and other employees similarly situated may commence an action to recover that liability in any court of competent jurisdiction. If the court finds that a contractor, subcontractor, or contractor's or subcontractor's agent has failed to pay the prevailing wage rate determined by the department under sub. (3) or has paid less than 1.5 times the hourly basic rate of pay for all hours worked in excess of the prevailing hours of labor, the court shall order the contractor, subcontractor, or agent to pay to any affected employee the amount of his or her unpaid wages or his or her unpaid overtime compensation and an additional amount equal to 100 percent of the amount of those unpaid wages or that unpaid overtime compensation as liquidated damages.

5. No employee may be a party plaintiff to an action under subd. 3. unless the employee consents in writing to become a party and the consent is filed in the court in which the action is brought. Notwithstanding s. 814.04 (1), the court shall, in addition to any judgment awarded to the plaintiff, allow reasonable attorney fees and costs to be paid by the defendant.

BUILDING OR HEAVY CONSTRUCTION

Includes sheltered enclosures with walk-in access for the purpose of housing persons, employees, machinery, equipment or supplies and non-sheltered work such as canals, dams, dikes, reservoirs, storage tanks, etc. A sheltered enclosure need not be "habitable" in order to be considered a building. The installation of machinery and/or equipment, both above and below grade level, does not change a project's character as a building. On-site grading, utility work and landscaping are included within this definition. Residential buildings of four (4) stories or less, agricultural buildings, parking lots and driveways are NOT included within this definition.

SKILLED TRADES

Fringe Benefits Must Be Paid On <u>All</u> Hours Worked		HOURLY BASIC RATE OF PAY	HOURLY FRINGE BENEFITS	TOTAL
CODE	TRADE OR OCCUPATION	\$	\$	\$
101	Acoustic Ceiling Tile Installer Future Increase(s): Add \$1.42/hr on 6/1/2016.	33.02	17.12	50.14
102	Boilermaker	33.35	28.29	61.64
103	Bricklayer, Blocklayer or Stonemason Future Increase(s): Add \$1.45 on 06/06/2016 Premium Increase(s): DOT PREMIUM: Pay two times the hourly basic rate on Sunday, New Year's Day, Memorial Day, Independence Day, Labor Day, Thanksgiving Day & Christmas Day.	32.86	20.03	52.89
104	Cabinet Installer Future Increase(s): Add \$1.42/hr on 6/1/2016.	33.02	17.12	50.14
105	Carpenter Future Increase(s): Add \$1.42/hr on 6/1/2016. Premium Increase(s): DOT PREMIUM: Pay two times the hourly basic rate on Sunday, New Year's Day, Memorial Day, Independence Day, Labor Day, Thanksgiving Day & Christmas Day.	33.02	17.12	50.14
106	Carpet Layer or Soft Floor Coverer Future Increase(s): Add \$1.42/hr on 6/1/2016.	33.02	17.12	50.14
107	Cement Finisher	33.15	16.40	49.55
108	Drywall Taper or Finisher	29.97	20.08	50.05
109	Electrician Future Increase(s): Add \$1.25/hr on 6/1/16. Premium Increase(s): DOT PREMIUM: Pay two times the hourly basic rate on Sunday, New Year's Day, Memorial Day, Independence Day, Labor Day, Thanksgiving Day & Christmas Day.	35.75	19.97	55.72
110	Elevator Constructor	46.05	27.09	73.14
111	Fence Erector	18.72	5.78	24.50

Fringe Benefits Must Be Paid On <u>All</u> Hours Worked		HOURLY BASIC RATE OF PAY	HOURLY FRINGE BENEFITS	TOTAL
CODE	TRADE OR OCCUPATION	\$	\$	\$
112	Fire Sprinkler Fitter	36.78	19.97	56.75
113	Glazier	38.27	14.42	52.69
114	Heat or Frost Insulator	33.53	27.31	60.84
115	Insulator (Batt or Blown) Future Increase(s): Add \$1.42/hr on 6/1/2016.	33.02	17.12	50.14
116	Ironworker	32.50	20.58	53.08
117	Lather	32.72	16.00	48.72
118	Line Constructor (Electrical)	40.81	18.06	58.87
119	Marble Finisher	25.72	18.54	44.26
120	Marble Mason	32.82	18.67	51.49
121	Metal Building Erector	22.40	6.27	28.67
122	Millwright Future Increase(s): Add \$1.47/hr on 6/1/2016.	34.79	17.17	51.96
123	Overhead Door Installer	31.93	13.39	45.32
124	Painter	26.70	16.65	43.35
125	Pavement Marking Operator	30.00	18.81	48.81
126	Piledriver Future Increase(s): Add \$1.44/hr on 6/1/2016. Premium Increase(s): DOT PREMIUM: Pay two times the hourly basic rate on Sunday, New Year's Day, Memorial Day, Independence Day, Labor Day, Thanksgiving Day & Christmas Day.	33.56	17.12	50.68
127	Pipeline Fuser or Welder (Gas or Utility)	44.20	18.26	62.46
129	Plasterer	32.82	18.81	51.63
130	Plumber	38.82	18.02	56.84
132	Refrigeration Mechanic	45.55	18.71	64.26
133	Roofer or Waterproofer	29.65	1.71	31.36
134	Sheet Metal Worker	35.55	24.67	60.22
135	Steamfitter	45.55	18.71	64.26
137	Teledata Technician or Installer	22.50	12.74	35.24
138	Temperature Control Installer	34.97	19.67	54.64
139	Terrazzo Finisher	25.72	18.54	44.26

Fringe Benefits Must Be Paid On <u>All</u> Hours Worked		HOURLY BASIC RATE OF PAY	HOURLY FRINGE BENEFITS	TOTAL
CODE	TRADE OR OCCUPATION	\$	\$	\$
140	Terrazzo Mechanic Future Increase(s): Add \$1.60 on 06/06/2016	33.98	18.96	52.94
141	Tile Finisher	30.00	0.00	30.00
142	Tile Setter Future Increase(s): Add \$1.45/hr on 6/06/2016.	31.59	19.61	51.20
143	Tuckpointer, Caulker or Cleaner Future Increase(s): Add \$1.45 on 06/06/2016 Premium Increase(s): DOT PREMIUM: Pay two times the hourly basic rate on Sunday, New Year's Day, Memorial Day, Independence Day, Labor Day, Thanksgiving Day & Christmas Day.	32.86	20.03	52.89
144	Underwater Diver (Except on Great Lakes)	36.74	16.00	52.74
146	Well Driller or Pump Installer Future Increase(s): Add \$1/hr on 6/1/2016; Add \$1/hr on 6/1/2017.	25.32	16.40	41.72
147	Siding Installer	17.00	6.71	23.71
150	Heavy Equipment Operator - ELECTRICAL LINE CONSTRUCTION ONLY	36.73	20.41	57.14
151	Light Equipment Operator -ELECTRICAL LINE CONSTRUCTION ONLY	32.65	15.52	48.17
152	Heavy Truck Driver - ELECTRICAL LINE CONSTRUCTION ONLY	28.57	13.71	42.28
153	Light Truck Driver - ELECTRICAL LINE CONSTRUCTION ONLY	26.53	13.55	40.08
154	Groundman - ELECTRICAL LINE CONSTRUCTION ONLY	25.00	12.55	37.55

TRUCK DRIVERS

Fringe Benefits Must Be Paid On <u>All</u> Hours Worked		HOURLY BASIC RATE OF PAY	HOURLY FRINGE BENEFITS	TOTAL
CODE	TRADE OR OCCUPATION	\$	\$	\$
201	Single Axle or Two Axle	33.69	19.78	53.47
203	Three or More Axle	18.25	21.61	39.86
204	Articulated, Euclid, Dumptor, Off Road Material Hauler Future Increase(s): Add \$1.60/hr on 6/3/2016.	34.69	20.38	55.07
205	Pavement Marking Vehicle	18.25	21.61	39.86
207	Truck Mechanic	18.25	21.61	39.86

LABORERS

Fringe Benefits Must Be Paid On <u>All</u> Hours Worked		HOURLY BASIC RATE OF PAY	HOURLY FRINGE BENEFITS	TOTAL
CODE	TRADE OR OCCUPATION	\$	\$	\$
301	General Laborer Future Increase(s): Add \$1.25/hr eff. 06/06/2016 Premium Increase(s): Add \$1.00/hr for certified welder and pipelayer; Add \$.25/hr for mason tender.	25.81	15.63	41.44
302	Asbestos Abatement Worker	17.00	4.22	21.22
303	Landscaper	21.90	9.83	31.73
310	Gas or Utility Pipeline Laborer (Other Than Sewer and Water)	20.83	18.39	39.22
311	Fiber Optic Laborer (Outside, Other Than Concrete Encased)	19.35	0.00	19.35
314	Railroad Track Laborer	17.00	3.96	20.96
315	Final Construction Clean-Up Worker	29.01	7.20	36.21

**HEAVY EQUIPMENT OPERATORS
SITE PREPARATION, UTILITY OR LANDSCAPING WORK ONLY**

Fringe Benefits Must Be Paid On <u>All</u> Hours Worked		HOURLY BASIC RATE OF PAY	HOURLY FRINGE BENEFITS	TOTAL
CODE	TRADE OR OCCUPATION	\$	\$	\$
501	Air Track, Rotary or Percussion Drilling Machine &/or Hammers, Blaster; Asphalt Milling Machine; Boring Machine (Directional, Horizontal or Vertical); Backhoe (Track Type) Having a Mfgr's Rated Capacity of 130,000 Lbs. or Over; Backhoe (Track Type) Having a Mfgr's Rated Capacity of Under 130,000 Lbs., Backhoe (Mini, 15,000 Lbs. & Under); Bulldozer or Endloader (Over 40 hp); Compactor (Self-Propelled 85 Ft Total Drum Width & Over, or Tractor Mounted, Towed & Light Equipment); Concrete Batch Plant, Batch Hopper; Concrete Breaker (Large, Auto, Vibratory/Sonic, Manual or Remote); Crane, Shovel, Dragline, Clamshells; Forklift (Machinery Moving or Steel Erection, 25 Ft & Over); Gradall (Cruz-Aire Type); Grader or Motor Patrol; Master Mechanic; Mechanic or Welder; Robotic Tool Carrier (With or Without Attachments); Scraper (Self Propelled or Tractor Drawn) 5 cu yds or More Capacity; Tractor or Truck Mounted Hydraulic Backhoe; Tractor or Truck Mounted Hydraulic Crane (10 Tons or Under); Tractor (Scraper, Dozer, Pusher, Loader); Trencher (Wheel Type or Chain Type Having Over 8 Inch Bucket). Future Increase(s): Add \$1.60/hr on 6/3/2016.	35.22	20.38	55.60
502	Backfiller; Broom or Sweeper; Bulldozer or Endloader (Under 40 hp); Environmental Burner; Forestry Equipment, Timbco, Tree Shear, Tub Grinder, Processor; Jeep Digger; Screed (Milling Machine); Skid Rig; Straddle Carrier or Travel Lift; Stump Chipper; Trencher (Wheel Type or Chain Type Having 8 Inch Bucket & Under). Future Increase(s): Add \$1.60/hr on 6/3/2016.	34.69	20.38	55.07

Fringe Benefits Must Be Paid On <u>All</u> Hours Worked		HOURLY BASIC RATE OF PAY	HOURLY FRINGE BENEFITS	TOTAL
CODE	TRADE OR OCCUPATION	\$	\$	\$
503	Air Compressor (&/or 400 CFM or Over); Augers (Vertical & Horizontal); Compactor (Self-Propelled 84 Ft Total Drum Width & Under, or Tractor Mounted, Towed & Light Equipment); Crusher, Screening or Wash Plant; Farm or Industrial Type Tractor; Forklift; Generator (&/or 150 KW or Over); Greaser; High Pressure Utility Locating Machine (Daylighting Machine); Mulcher; Oiler; Post Hole Digger or Driver; Pump (3 Inch or Over) or Well Points; Refrigeration Plant or Freeze Machine; Rock, Stone Breaker; Skid Steer Loader (With or Without Attachments); Vibratory Hammer or Extractor, Power Pack. Future Increase(s): Add \$1.60/hr on 6/3/2016.	32.62	20.38	53.00
504	Work Performed on the Great Lakes Including Diver; Wet Tender or Hydraulic Dredge Engineer.	41.65	21.71	63.36
505	Work Performed on the Great Lakes Including Crane or Backhoe Operator; Assistant Hydraulic Dredge Engineer; Hydraulic Dredge Leverman or Diver's Tender; Mechanic or Welder; 70 Ton & Over Tug Operator. Future Increase(s): Add \$1.25/hr on 1/1/2017. Premium Increase(s): Add \$.50/hr for Friction Crane, Lattice Boom or Crane Certification (CCO).	44.05	23.24	67.29
506	Work Performed on the Great Lakes Including Deck Equipment Operator or Machineryman (Maintains Cranes Over 50 Tons or Backhoes 115,000 Lbs. or More); Tug, Launch or Loader, Dozer or Like Equipment When Operated on a Barge, Breakwater Wall, Slip, Dock or Scow, Deck Machinery. Future Increase(s): Add \$1.25/hr on 1/1/2017.	39.20	23.09	62.29
507	Work Performed on the Great Lakes Including Deck Equipment Operator, Machineryman or Fireman (Operates 4 Units or More or Maintains Cranes 50 Tons or Under or Backhoes 115,000 Lbs. or Under); Deck Hand, Deck Engineer or Assistant Tug Operator; Off Road Trucks - Great Lakes ONLY.	36.72	21.15	57.87

**HEAVY EQUIPMENT OPERATORS
EXCLUDING SITE PREPARATION, UTILITY, PAVING LANDSCAPING WORK**

Fringe Benefits Must Be Paid On <u>All</u> Hours Worked		HOURLY BASIC RATE OF PAY	HOURLY FRINGE BENEFITS	TOTAL
CODE	TRADE OR OCCUPATION	\$	\$	\$
508	Boring Machine (Directional); Crane, Tower Crane, Pedestal Tower or Derrick, With or Without Attachments, With a Lifting Capacity of Over 100 Tons, Self-Erecting Tower Crane With a Lifting Capacity of Over 4,000 Lbs., Crane With Boom Dollies; Crane, Tower Crane, Pedestal Tower or Derrick, With Boom, Leads &/or Jib Lengths Measuring 176 Ft or Over; Master Mechanic. Future Increase(s): Add \$1.60/hr on 6/3/2016. Premium Increase(s):	37.67	20.38	58.05

Fringe Benefits Must Be Paid On <u>All</u> Hours Worked		HOURLY BASIC RATE OF PAY	HOURLY FRINGE BENEFITS	TOTAL
CODE	TRADE OR OCCUPATION	\$	\$	\$
	Add \$.50/hr for >200 Ton; Add \$1/hr at 300 Ton; Add \$1.50/hr at 400 Ton; Add \$2/hr at 500 Ton & Over.			
509	Backhoe (Track Type) Having a Mfgr's Rated Capacity of 130,000 Lbs. or Over; Boring Machine (Horizontal or Vertical); Caisson Rig; Crane, Tower Crane, Portable Tower, Pedestal Tower or Derrick, With or Without Attachments, With a Lifting Capacity of 100 Tons or Under, Self-Erecting Tower Crane With A Lifting Capacity Of 4,000 Lbs. & Under; Crane, Tower Crane, Portable Tower, Pedestal Tower or Derrick, With Boom, Leads &/or Jib Lengths Measuring 175 Ft or Under; Pile Driver; Versi Lifts, Tri-Lifts & Gantrys (20,000 Lbs. & Over). Future Increase(s): Add \$1.60/hr on 6/3/2016. Premium Increase(s): Add \$.25/hr for all >45 Ton lifting capacity cranes.	36.42	20.38	56.80
510	Backhoe (Track Type) Having a Mfgr.'s Rated Capacity of Under 130,000 Lbs., Backhoe (Mini, 15,000 Lbs. & Under); Concrete Bump Cutter, Grinder, Planing or Grooving Machine; Concrete Laser/Screed; Concrete Paver (Slipform); Concrete Pump (Over 46 Meter), Concrete Conveyor (Rotec or Bidwell Type); Concrete Slipform Placer Curb & Gutter Machine; Concrete Spreader & Distributor; Dredge (NOT Performing Work on the Great Lakes); Forklift (Machinery Moving or Steel Erection, 25 Ft & Over); Gradall (Cruz-Aire Type); Hydro-Blaster (10,000 PSI or Over); Milling Machine; Skid Rig; Traveling Crane (Bridge Type). Future Increase(s): Add \$1.60/hr on 6/3/2016.	35.22	20.38	55.60
511	Air, Track, Rotary or Percussion Drilling Machine &/or Hammers, Blaster; Bulldozer or Endloader (Over 40 hp); Compactor (Self-Propelled 85 Ft Total Drum Width & Over, or Tractor Mounted, Towed & Light Equipment); Concrete Pump (46 Meter & Under), Concrete Conveyor (Rotec or Bidwell Type); Crane (Carry Deck, Mini) or Truck Mounted Hydraulic Crane (10 Tons or Under); Environmental Burner; Gantrys (Under 20,000 Lbs.); Grader or Motor Patrol; High Pressure Utility Locating Machine (Daylighting Machine); Manhoist; Material or Stack Hoist; Mechanic or Welder; Railroad Track Rail Leveling Machine, Tie Placer, Extractor, Tamper, Stone Leveler or Rehabilitation Equipment; Roller (Over 5 Ton); Scraper (Self Propelled or Tractor Drawn) 5 cu yd or More Capacity; Screed (Milling Machine); Sideboom; Straddle Carrier or Travel Lift; Tining or Curing Machine; Tractor (Scraper, Dozer, Pusher, Loader); Tractor or Truck Mounted Hydraulic Backhoe; Tractor or Truck Mounted Hydraulic Crane (10 Tons or Under); Trencher (Wheel Type or Chain Type Having Over 8-Inch Bucket). Future Increase(s): Add \$1.60/hr on 6/3/2016.	34.69	20.38	55.07

Fringe Benefits Must Be Paid On <u>All</u> Hours Worked		HOURLY BASIC RATE OF PAY	HOURLY FRINGE BENEFITS	TOTAL
CODE	TRADE OR OCCUPATION	\$	\$	\$
512	Backfiller; Broom or Sweeper; Bulldozer or Endloader (Under 40 hp); Compactor (Self-Propelled 84 Ft Total Drum Width & Under, or Tractor Mounted, Towed & Light Equipment); Concrete Batch Plant, Batch Hopper; Concrete Breaker (Large, Auto, Vibratory/Sonic, Manual or Remote); Concrete Conveyor System; Concrete Finishing Machine (Road Type); Fireman (Pile Driver & Derrick NOT Performing Work on the Great Lakes); Grout Pump; Hoist (Tugger, Automatic); Industrial Locomotives; Jeep Digger; Lift Slab Machine; Mulcher; Roller (Rubber Tire, 5 Ton or Under); Screw or Gypsum Pumps; Stabilizing or Concrete Mixer (Self-Propelled or 14S or Over); Stump Chipper; Trencher (Wheel Type or Chain Type Having 8-Inch Bucket & Under); Winches & A-Frames. Future Increase(s): Add \$1.60/hr on 6/3/2016.	32.62	20.38	53.00
513	Air Compressor (&/or 400 CFM or Over); Air, Electric or Hydraulic Jacking System; Augers (Vertical & Horizontal); Boatmen (NOT Performing Work on the Great Lakes); Boiler (Temporary Heat); Crusher, Screening or Wash Plant; Elevator; Farm or Industrial Type Tractor; Fireman (Asphalt Plant NOT Performing Work on the Great Lakes); Forklift; Generator (&/or 150 KW or Over); Greaser; Heaters (Mechanical); Loading Machine (Conveyor); Oiler; Post Hole Digger or Driver; Prestress Machine; Pump (3 Inch or Over) or Well Points; Refrigeration Plant or Freeze Machine; Robotic Tool Carrier (With or Without Attachments); Rock, Stone Breaker; Skid Steer Loader (With or Without Attachments); Vibratory Hammer or Extractor, Power Pack. Future Increase(s): Add \$1.60/hr on 6/3/2016.	31.99	20.38	52.37
514	Gas or Utility Pipeline, Except Sewer & Water (Primary Equipment). Future Increase(s): Add \$1/hr on 5/30/2016.	37.04	22.44	59.48
515	Gas or Utility Pipeline, Except Sewer & Water (Secondary Equipment).	33.82	20.30	54.12
516	Fiber Optic Cable Equipment	29.50	0.68	30.18

SEWER, WATER OR TUNNEL CONSTRUCTION
--

Includes those projects that primarily involve public sewer or water distribution, transmission or collection systems and related tunnel work (excluding buildings).

SKILLED TRADES

CODE	TRADE OR OCCUPATION	FRINGE BENEFITS MUST BE PAID ON <u>All</u> Hours Worked	HOURLY BASIC RATE OF PAY	HOURLY FRINGE BENEFITS	TOTAL
			\$	\$	\$
103	Bricklayer, Blocklayer or Stonemason		32.82	18.67	51.49
105	Carpenter		32.72	16.00	48.72
107	Cement Finisher Future Increase(s): Add \$1.75 on 6/1/16. Premium Increase(s): DOT PREMIUMS: 1) Pay two times the hourly basic rate on Sunday, New Year's Day, Memorial Day, Independence Day, Labor Day, Thanksgiving Day & Christmas Day. 2) Add \$1.40/hr when the Wisconsin Department of Transportation or responsible governing agency requires that work be performed at night under artificial illumination with traffic control and the work is completed after sunset and before sunrise.		35.97	17.85	53.82
109	Electrician		52.00	1.50	53.50
111	Fence Erector		18.72	5.78	24.50
116	Ironworker		32.50	20.58	53.08
118	Line Constructor (Electrical)		40.81	18.06	58.87
125	Pavement Marking Operator		30.00	18.81	48.81
126	Piledriver		33.24	16.00	49.24
130	Plumber Future Increase(s): Add \$1.50 on 6/1/16		39.95	19.45	59.40
135	Steamfitter		44.20	18.26	62.46
137	Teledata Technician or Installer		22.50	12.74	35.24
143	Tuckpointer, Caulker or Cleaner		32.82	18.67	51.49
144	Underwater Diver (Except on Great Lakes)		31.00	20.43	51.43
146	Well Driller or Pump Installer Future Increase(s): Add \$1/hr on 6/1/2016; Add \$1/hr on 6/1/2017.		25.32	16.40	41.72
150	Heavy Equipment Operator - ELECTRICAL LINE CONSTRUCTION ONLY		36.73	15.92	52.65
151	Light Equipment Operator -ELECTRICAL LINE CONSTRUCTION ONLY		32.65	15.52	48.17

Fringe Benefits Must Be Paid On <u>All</u> Hours Worked		HOURLY BASIC RATE OF PAY	HOURLY FRINGE BENEFITS	TOTAL
CODE	TRADE OR OCCUPATION	\$	\$	\$
152	Heavy Truck Driver - ELECTRICAL LINE CONSTRUCTION ONLY	28.57	13.71	42.28
153	Light Truck Driver - ELECTRICAL LINE CONSTRUCTION ONLY	26.53	13.55	40.08
154	Groundman - ELECTRICAL LINE CONSTRUCTION ONLY	21.75	12.97	34.72

TRUCK DRIVERS

Fringe Benefits Must Be Paid On <u>All</u> Hours Worked		HOURLY BASIC RATE OF PAY	HOURLY FRINGE BENEFITS	TOTAL
CODE	TRADE OR OCCUPATION	\$	\$	\$
201	Single Axle or Two Axle	19.00	0.00	19.00
203	Three or More Axle	19.00	0.00	19.00
204	Articulated, Euclid, Dumptor, Off Road Material Hauler	33.69	19.78	53.47
205	Pavement Marking Vehicle	19.00	0.00	19.00
207	Truck Mechanic	19.00	0.00	19.00

LABORERS

Fringe Benefits Must Be Paid On <u>All</u> Hours Worked		HOURLY BASIC RATE OF PAY	HOURLY FRINGE BENEFITS	TOTAL
CODE	TRADE OR OCCUPATION	\$	\$	\$
301	General Laborer Future Increase(s): Add \$1.25/hr eff. 06/06/2016 Premium Increase(s): Add \$.20 for blaster, bracer, manhole builder, caulker, bottomman and power tool; Add \$.55 for pipelayer; Add \$1.00 for tunnel work 0-15 lbs. compressed air; Add \$2.00 for over 15-30 lbs. compressed air; Add \$3.00 for over 30 lbs. compressed air.	27.18	15.64	42.82
303	Landscaper	41.00	0.00	41.00
304	Flagperson or Traffic Control Person	20.92	14.80	35.72
311	Fiber Optic Laborer (Outside, Other Than Concrete Encased)	19.35	0.00	19.35
314	Railroad Track Laborer	17.00	3.96	20.96

**HEAVY EQUIPMENT OPERATORS
SEWER, WATER OR TUNNEL WORK**

Fringe Benefits Must Be Paid On <u>All</u> Hours Worked		HOURLY BASIC RATE OF PAY	HOURLY FRINGE BENEFITS	TOTAL
CODE	TRADE OR OCCUPATION	\$	\$	\$
521	Backhoe (Track Type) Having a Mfgr.'s Rated Capacity of 130,000 Lbs. or Over; Caisson Rig; Crane, Tower Crane, Pedestal Tower or Derrick, With Boom, Leads &/or Jib Lengths Measuring 176 Ft or Over; Crane, Tower Crane, Pedestal Tower or Derrick, With or Without Attachments, With a Lifting Capacity of Over 100 Tons, Self-Erecting Tower Crane With a Lifting Capacity Of Over 4,000 Lbs., Crane With Boom Dollies; Master Mechanic; Pile Driver. Premium Increase(s): Add \$.25/hr for operating tower crane.	38.09	20.80	58.89
522	Backhoe (Track Type) Having a Mfgr.'s Rated Capacity of Under 130,000 Lbs., Backhoe (Mini, 15,000 Lbs. & Under); Boring Machine (Directional); Concrete Bump Cutter, Grinder, Planing or Grooving Machine; Concrete Laser/Screed; Concrete Paver (Slipform); Concrete Pump (Over 46 Meter), Concrete Conveyor (Rotec or Bidwell Type); Concrete Spreader & Distributor; Crane, Tower Crane, Portable Tower, Pedestal Tower or Derrick, With Boom, Leads &/or Jib Lengths Measuring 175 Ft or Under; Crane, Tower Crane, Portable Tower, Pedestal Tower or Derrick, With or Without Attachments, With a Lifting Capacity of 100 Tons or Under, Self-Erecting Tower Crane With a Lifting Capacity of 4,000 Lbs. & Under; Dredge (NOT Performing Work on the Great Lakes); Milling Machine; Skid Rig; Telehandler; Traveling Crane (Bridge Type). Future Increase(s): Add \$1.60/hr on 6/3/2016.	35.22	20.38	55.60
523	Air Track, Rotary or Percussion Drilling Machine &/or Hammers, Blaster; Boring Machine (Horizontal or Vertical); Bulldozer or Endloader (Over 40 hp); Crane (Carry Deck, Mini) or Truck Mounted Hydraulic Crane (10 Tons or Under); Concrete Pump (46 Meter & Under), Concrete Conveyor (Rotec or Bidwell Type); Concrete Slipform Placer Curb & Gutter Machine; Gradall (Cruz-Aire Type); Grader or Motor Patrol; Hydro-Blaster (10,000 PSI or Over); Manhoist; Material or Stack Hoist; Mechanic or Welder; Roller (Over 5 Ton); Scraper (Self Propelled or Tractor Drawn) 5 cu yd or More Capacity; Screed (Milling Machine); Sideboom; Straddle Carrier or Travel Lift; Tractor (Scraper, Dozer, Pusher, Loader); Tractor or Truck Mounted Hydraulic Backhoe; Tractor or Truck Mounted Hydraulic Crane (10 Tons or Under); Trencher (Wheel Type or Chain Type Having Over 8-Inch Bucket). Future Increase(s): Add \$1.60/hr on 6/3/2016.	34.69	20.38	55.07

Fringe Benefits Must Be Paid On <u>All</u> Hours Worked		HOURLY BASIC RATE OF PAY	HOURLY FRINGE BENEFITS	TOTAL
CODE	TRADE OR OCCUPATION	\$	\$	\$
524	Backfiller; Broom or Sweeper; Bulldozer or Endloader (Under 40 hp); Compactor (Self-Propelled 85 Ft Total Drum Width & Over, or Tractor Mounted, Towed & Light Equipment); Concrete Batch Plant, Batch Hopper; Concrete Breaker (Large, Auto, Vibratory/Sonic, Manual or Remote); Concrete Conveyor System; Concrete Finishing Machine (Road Type); Environmental Burner; Fireman (Pile Driver & Derrick NOT Performing Work on the Great Lakes); Forestry Equipment, Timbco, Tree Shear, Tub Grinder, Processor; Hoist (Tugger, Automatic); Grout Pump; Jeep Digger; Lift Slab Machine; Mulcher; Power Subgrader; Pump (3 Inch or Over) or Well Points; Robotic Tool Carrier (With or Without Attachments); Roller (Rubber Tire, 5 Ton or Under); Screw or Gypsum Pumps; Stabilizing or Concrete Mixer (Self-Propelled or 14S or Over); Stump Chipper; Tining or Curing Machine; Trencher (Wheel Type or Chain Type Having 8-Inch Bucket & Under); Winches & A-Frames.	33.69	21.75	55.44
525	Air Compressor (&/or 400 CFM or Over); Air, Electric or Hydraulic Jacking System; Augers (Vertical & Horizontal); Compactor (Self-Propelled 84 Ft Total Drum Width & Under, or Tractor Mounted, Towed & Light Equipment); Crusher, Screening or Wash Plant; Farm or Industrial Type Tractor; Fireman (Asphalt Plant NOT Performing Work on the Great Lakes); Generator (&/or 150 KW or Over); Heaters (Mechanical); High Pressure Utility Locating Machine (Daylighting Machine); Loading Machine (Conveyor); Post Hole Digger or Driver; Refrigeration Plant or Freeze Machine; Rock, Stone Breaker; Skid Steer Loader (With or Without Attachments); Vibratory Hammer or Extractor, Power Pack. Future Increase(s): Add \$1.60/hr on 6/3/2016.	31.99	20.38	52.37
526	Boiler (Temporary Heat); Forklift; Greaser; Oiler.	30.99	19.78	50.77
527	Work Performed on the Great Lakes Including Diver; Wet Tender or Hydraulic Dredge Engineer.	41.65	21.71	63.36
528	Work Performed on the Great Lakes Including 70 Ton & Over Tug Operator; Assistant Hydraulic Dredge Engineer; Crane or Backhoe Operator; Hydraulic Dredge Leverman or Diver's Tender; Mechanic or Welder.	41.65	21.71	63.36
529	Work Performed on the Great Lakes Including Deck Equipment Operator or Machineryman (Maintains Cranes Over 50 Tons or Backhoes 115,000 Lbs. or More); Tug, Launch or Loader, Dozer or Like Equipment When Operated on a Barge, Breakwater Wall, Slip, Dock or Scow, Deck Machinery.	36.72	21.15	57.87
530	Work Performed on the Great Lakes Including Deck Equipment Operator; Machineryman or Fireman (Operates 4 Units or More or Maintains Cranes 50 Tons or Under or Backhoes 115,000 Lbs. or Under), Deck Hand, Deck Engineer or Assistant Tug Operator; Off Road Trucks - Great Lakes ONLY.	36.72	21.15	57.87

LOCAL STREET OR MISCELLANEOUS PAVING CONSTRUCTION
--

Includes roads, streets, alleys, trails, bridges, paths, racetracks, parking lots and driveways (except residential or agricultural), public sidewalks or other similar projects (excluding projects awarded by the Wisconsin Department of Transportation).

SKILLED TRADES

<u>CODE</u>	<u>TRADE OR OCCUPATION</u>	<u>HOURLY BASIC RATE OF PAY</u>	<u>HOURLY FRINGE BENEFITS</u>	<u>TOTAL</u>
		\$	\$	\$
103	Bricklayer, Blocklayer or Stonemason	32.82	18.67	51.49
105	Carpenter Future Increase(s): Add \$1.42/hr on 6/1/2016. Premium Increase(s): DOT PREMIUM: Pay two times the hourly basic rate on Sunday, New Year's Day, Memorial Day, Independence Day, Labor Day, Thanksgiving Day & Christmas Day.	33.02	17.12	50.14
107	Cement Finisher Future Increase(s): Add \$1.75 on 6/1/16. Premium Increase(s): DOT PREMIUMS: 1) Pay two times the hourly basic rate on Sunday, New Year's Day, Memorial Day, Independence Day, Labor Day, Thanksgiving Day & Christmas Day. 2) Add \$1.40/hr when the Wisconsin Department of Transportation or responsible governing agency requires that work be performed at night under artificial illumination with traffic control and the work is completed after sunset and before sunrise.	35.97	17.85	53.82
109	Electrician Future Increase(s): Add \$1.25/hr on 6/1/16. Premium Increase(s): DOT PREMIUM: Pay two times the hourly basic rate on Sunday, New Year's Day, Memorial Day, Independence Day, Labor Day, Thanksgiving Day & Christmas Day.	35.75	19.97	55.72
111	Fence Erector	18.72	5.78	24.50
116	Ironworker	32.50	20.58	53.08
118	Line Constructor (Electrical)	40.81	18.06	58.87
124	Painter	26.70	16.65	43.35
125	Pavement Marking Operator	30.00	18.81	48.81
126	Piledriver Future Increase(s): Add \$1.44/hr on 6/1/2016. Premium Increase(s): DOT PREMIUM: Pay two times the hourly basic rate on Sunday, New Year's Day, Memorial Day, Independence Day, Labor Day, Thanksgiving Day & Christmas Day.	33.56	17.12	50.68

Fringe Benefits Must Be Paid On <u>All</u> Hours Worked		HOURLY BASIC RATE OF PAY	HOURLY FRINGE BENEFITS	TOTAL
CODE	TRADE OR OCCUPATION	\$	\$	\$
133	Roofer or Waterproofer	29.65	1.71	31.36
137	Teledata Technician or Installer	22.50	12.74	35.24
143	Tuckpointer, Caulker or Cleaner	32.82	18.67	51.49
144	Underwater Diver (Except on Great Lakes)	36.74	16.00	52.74
150	Heavy Equipment Operator - ELECTRICAL LINE CONSTRUCTION ONLY	36.73	15.92	52.65
151	Light Equipment Operator -ELECTRICAL LINE CONSTRUCTION ONLY	32.65	15.52	48.17
152	Heavy Truck Driver - ELECTRICAL LINE CONSTRUCTION ONLY	28.57	13.71	42.28
153	Light Truck Driver - ELECTRICAL LINE CONSTRUCTION ONLY	26.53	13.55	40.08
154	Groundman - ELECTRICAL LINE CONSTRUCTION ONLY	21.75	12.97	34.72

TRUCK DRIVERS

Fringe Benefits Must Be Paid On <u>All</u> Hours Worked		HOURLY BASIC RATE OF PAY	HOURLY FRINGE BENEFITS	TOTAL
CODE	TRADE OR OCCUPATION	\$	\$	\$
201	Single Axle or Two Axle	18.00	0.00	18.00
203	Three or More Axle	18.00	0.00	18.00
204	Articulated, Euclid, Dumptor, Off Road Material Hauler Future Increase(s): Add \$1.60/hr on 6/3/2016.	34.69	20.38	55.07
205	Pavement Marking Vehicle	18.00	0.00	18.00
206	Shadow or Pilot Vehicle	18.00	0.00	18.00
207	Truck Mechanic	18.00	0.00	18.00

LABORERS

Fringe Benefits Must Be Paid On <u>All</u> Hours Worked		HOURLY BASIC RATE OF PAY	HOURLY FRINGE BENEFITS	TOTAL
CODE	TRADE OR OCCUPATION	\$	\$	\$
301	General Laborer	26.34	15.17	41.51

Fringe Benefits Must Be Paid On <u>All</u> Hours Worked		HOURLY BASIC RATE OF PAY	HOURLY FRINGE BENEFITS	TOTAL
CODE	TRADE OR OCCUPATION	\$	\$	\$
303	Landscaper Future Increase(s): Add \$1.00/hr eff. 06/01/2016; Add \$1.00/hr eff. 06/01/2017 Premium Increase(s): DOT PREMIUMS: 1) Pay two times the hourly basic rate on Sunday, New Year's Day, Memorial Day, Independence Day, Labor Day, Thanksgiving Day & Christmas Day. 2) Add \$1.25/hr for work on projects involving temporary traffic control setup, for lane and shoulder closures, when work under artificial illumination conditions is necessary as required by the project provisions (including prep time prior to and/or cleanup after such time period).	30.67	15.65	46.32
304	Flagperson or Traffic Control Person	20.92	14.80	35.72
311	Fiber Optic Laborer (Outside, Other Than Concrete Encased)	19.35	0.00	19.35
314	Railroad Track Laborer	17.00	3.96	20.96

**HEAVY EQUIPMENT OPERATORS
CONCRETE PAVEMENT OR BRIDGE WORK**

Fringe Benefits Must Be Paid On <u>All</u> Hours Worked		HOURLY BASIC RATE OF PAY	HOURLY FRINGE BENEFITS	TOTAL
CODE	TRADE OR OCCUPATION	\$	\$	\$
541	Crane, Tower Crane, Pedestal Tower or Derrick, With or Without Attachments, With a Lifting Capacity of Over 100 Tons, Self-Erecting Tower Crane With a Lifting Capacity Of Over 4,000 Lbs., Crane With Boom Dollies; Crane, Tower Crane, Pedestal Tower or Derrick, With Boom, Leads &/or Jib Lengths Measuring 176 Ft or Over; Master Mechanic. Future Increase(s): Add \$1.60/hr on 6/3/2016. Premium Increase(s): Add \$.50/hr for >200 Ton; Add \$1/hr at 300 Ton; Add \$1.50/hr at 400 Ton; Add \$2/hr at 500 Ton & Over.	37.67	20.38	58.05

Fringe Benefits Must Be Paid On <u>All</u> Hours Worked		HOURLY BASIC RATE OF PAY	HOURLY FRINGE BENEFITS	TOTAL
CODE	TRADE OR OCCUPATION	\$	\$	\$
542	<p>Backhoe (Track Type) Having a Mfgr.'s Rated Capacity of 130,000 Lbs. or Over; Caisson Rig; Crane, Tower Crane, Portable Tower, Pedestal Tower or Derrick, With or Without Attachments, With a Lifting Capacity of 100 Tons or Under, Self-Erecting Tower Crane With a Lifting Capacity of 4,000 Lbs. & Under; Crane, Tower Crane Portable Tower, Pedestal Tower or Derrick, With Boom, Leads &/or Jib Lengths Measuring 175 Ft or Under; Dredge (NOT Performing Work on the Great Lakes); Licensed Boat Pilot (NOT Performing Work on the Great Lakes); Pile Driver.</p> <p>Future Increase(s): Add \$1.30/hr on 6/1/2016; Add \$1.25/hr on 6/1/2017.</p> <p>Premium Increase(s): DOT PREMIUMS: 1) Pay two times the hourly basic rate on Sunday, New Year's Day, Memorial Day, Independence Day, Labor Day, Thanksgiving Day & Christmas Day. 2) Add \$1.50/hr night work premium. See DOT'S website for details about the applicability of this night work premium at: http://wisconsin.gov/Pages/doing-bus/civil-rights/labornwage/prevaling-wage-compliance.aspx.</p>	37.77	21.85	59.62
543	<p>Air Track, Rotary or Percussion Drilling Machine &/or Hammers, Blaster; Automatic Subgrader (Concrete); Backhoe (Track Type) Having a Mfgr.'s Rated Capacity of Under 130,000 Lbs., Backhoe (Mini, 15,000 Lbs. & Under); Boring Machine (Directional, Horizontal or Vertical); Bridge (Bidwell) Paver; Bulldozer or Endloader; Concrete Batch Plant, Batch Hopper; Concrete Breaker (Large, Auto, Vibratory/Sonic, Manual or Remote); Concrete Bump Cutter, Grinder, Planing or Grooving Machine; Concrete Conveyor System; Concrete Laser/Screed; Concrete Paver (Slipform); Concrete Pump, Concrete Conveyor (Rotec or Bidwell Type); Concrete Slipform Placer Curb & Gutter Machine; Concrete Spreader & Distributor; Crane (Carry Deck, Mini) or Truck Mounted Hydraulic Crane (10 Tons or Under); Crane With a Lifting Capacity of 25 Tons or Under; Forestry Equipment, Timbco, Tree Shear, Tub Grinder, Processor; Gradall (Cruz-Aire Type); Grader or Motor Patrol; Grout Pump; Hydro-Blaster (10,000 PSI or Over); Loading Machine (Conveyor); Manhoist; Material or Stack Hoist; Mechanic or Welder; Milling Machine; Post Hole Digger or Driver; Scraper (Self Propelled or Tractor Drawn) 5 cu yds or More Capacity; Shoulder Widener; Sideboom; Skid Rig; Stabilizing or Concrete Mixer (Self-Propelled or 14S or Over); Straddle Carrier or Travel Lift; Tractor (Scraper, Dozer, Pusher, Loader); Tractor or Truck Mounted Hydraulic Backhoe; Trencher (Wheel Type or Chain Type); Tube Finisher; Tugger (NOT Performing Work on the Great Lakes); Winches & A-Frames.</p> <p>Future Increase(s): Add \$1.30/hr on 6/1/2016; Add \$1.25/hr on 6/1/2017.</p> <p>Premium Increase(s): DOT PREMIUMS: 1) Pay two times the hourly basic rate on Sunday, New Year's Day, Memorial Day, Independence Day, Labor Day, Thanksgiving Day & Christmas Day. 2) Add \$1.50/hr night work premium. See DOT'S website for details about the applicability of this night work premium at: http://wisconsin.gov/Pages/doing-bus/civil-rights/labornwage/prevaling-wage-compliance.aspx.</p>	37.27	21.85	59.12

Fringe Benefits Must Be Paid On <u>All</u> Hours Worked		HOURLY BASIC RATE OF PAY	HOURLY FRINGE BENEFITS	TOTAL
CODE	TRADE OR OCCUPATION	\$	\$	\$
544	Backfiller; Belting, Burlap, Texturing Machine; Broom or Sweeper; Compactor (Self-Propelled or Tractor Mounted, Towed & Light Equipment); Concrete Finishing Machine (Road Type); Environmental Burner; Farm or Industrial Type Tractor; Fireman (Pile Driver & Derrick NOT Performing Work on the Great Lakes); Forklift; Greaser; Jeep Digger; Joint Sawyer (Multiple Blade); Launch (NOT Performing Work on the Great Lakes); Lift Slab Machine; Mechanical Float; Mulcher; Power Subgrader; Robotic Tool Carrier (With or Without Attachments); Self Propelled Chip Spreader; Shouldering Machine; Skid Steer Loader (With or Without Attachments); Telehandler; Tining or Curing Machine. Future Increase(s): Add \$1.30/hr on 6/1/2016; Add \$1.25/hr on 6/1/2017. Premium Increase(s): DOT PREMIUMS: 1) Pay two times the hourly basic rate on Sunday, New Year's Day, Memorial Day, Independence Day, Labor Day, Thanksgiving Day & Christmas Day. 2) Add \$1.50/hr night work premium. See DOT'S website for details about the applicability of this night work premium at: http://wisconsindot.gov/Pages/doing-bus/civil-rights/labornwage/prevailing-wage-compliance.aspx .	37.27	21.85	59.12
545	Air Compressor (&/or 400 CFM or Over); Air, Electric or Hydraulic Jacking System; Automatic Belt Conveyor & Surge Bin; Boiler (Temporary Heat); Concrete Proportioning Plant; Crusher, Screening or Wash Plant; Generator (&/or 150 KW or Over); Heaters (Mechanical); High Pressure Utility Locating Machine (Daylighting Machine); Mudjack; Oiler; Prestress Machine; Pug Mill; Pump (3 Inch or Over) or Well Points; Rock, Stone Breaker; Screed (Milling Machine); Stump Chipper; Tank Car Heaters; Vibratory Hammer or Extractor, Power Pack.	31.62	19.78	51.40
546	Fiber Optic Cable Equipment.	29.50	0.68	30.18
547	Work Performed on the Great Lakes Including Diver; Wet Tender or Hydraulic Dredge Engineer.	41.65	21.71	63.36
548	Work Performed on the Great Lakes Including 70 Ton & Over Tug Operator; Assistant Hydraulic Dredge Engineer; Crane or Backhoe Operator; Hydraulic Dredge Leverman or Diver's Tender; Mechanic or Welder. Future Increase(s): Add \$1.25/hr on 1/1/2017. Premium Increase(s): Add \$.50/hr for Friction Crane, Lattice Boom or Crane Certification (CCO).	44.05	23.24	67.29
549	Work Performed on the Great Lakes Including Deck Equipment Operator or Machineryman (Maintains Cranes Over 50 Tons or Backhoes 115,000 Lbs. or more); Tug, Launch or Loader, Dozer or Like Equipment When Operated on a Barge, Breakwater Wall, Slip, Dock or Scow, Deck Machinery.	36.72	21.15	57.87

550	Work Performed on the Great Lakes Including Deck Equipment Operator; Machineryman or Fireman (Operates 4 Units or More or Maintains Cranes 50 Tons or Under or Backhoes 115,000 Lbs. or Under); Deck Hand, Deck Engineer or Assistant Tug Operator; Off Road Trucks - Great Lakes ONLY.	36.72	21.15	57.87
-----	---	-------	-------	-------

**HEAVY EQUIPMENT OPERATORS
ASPHALT PAVEMENT OR OTHER WORK**

Fringe Benefits Must Be Paid On <u>All</u> Hours Worked		HOURLY BASIC RATE OF PAY	HOURLY FRINGE BENEFITS	TOTAL
CODE	TRADE OR OCCUPATION	\$	\$	\$
551	Crane, Tower Crane, Pedestal Tower or Derrick, With or Without Attachments, With a Lifting Capacity of Over 100 Tons, Self Erecting Tower Crane With a Lifting Capacity of Over 4,000 Lbs., Crane With Boom Dollies; Crane, Tower Crane, Pedestal Tower or Derrick, With Boom, Leads and/or Jib Lengths Measuring 176 Ft or Over; Master Mechanic.	36.67	19.78	56.45
552	Backhoe (Track Type) Having a Mfgr.'s Rated Capacity of 130,000 Lbs. or Over; Caisson Rig; Crane, Tower Crane, Portable Tower, Pedestal Tower or Derrick, With or Without Attachments, With a Lifting Capacity of 100 Tons or Under, Self-Erecting Tower Crane With a Lifting Capacity Of 4,000 Lbs. & Under; Crane, Tower Crane, Portable Tower, Pedestal Tower or Derrick, With Boom, Leads &/or Jib Lengths Measuring 175 Ft or Under; Dredge (NOT Performing Work on the Great Lakes); Licensed Boat Pilot (NOT Performing Work on the Great Lakes); Pile Driver. Future Increase(s): Add \$1.30/hr on 6/1/2016; Add \$1.25/hr on 6/1/2017. Premium Increase(s): DOT PREMIUMS: 1) Pay two times the hourly basic rate on Sunday, New Year's Day, Memorial Day, Independence Day, Labor Day, Thanksgiving Day & Christmas Day. 2) Add \$1.50/hr night work premium. See DOT'S website for details about the applicability of this night work premium at: http://wisconsindot.gov/Pages/doing-bus/civil-rights/labornwage/prevaling-wage-compliance.aspx .	37.77	21.85	59.62

Fringe Benefits Must Be Paid On <u>All</u> Hours Worked		HOURLY BASIC RATE OF PAY	HOURLY FRINGE BENEFITS	TOTAL
CODE	TRADE OR OCCUPATION	\$	\$	\$
553	Air, Track, Rotary or Percussion Drilling Machine &/or Hammers, Blaster; Asphalt Heater, Planer & Scarifier; Asphalt Milling Machine; Asphalt Screed; Backhoe (Track Type) Having a Mfgr.'s Rated Capacity of Under 130,000 Lbs., Backhoe (Mini, 15,000 Lbs. & Under); Bituminous (Asphalt) Plant & Paver, Screed; Boring Machine (Directional, Horizontal or Vertical); Bulldozer or Endloader; Concrete Breaker (Large, Auto, Vibratory/Sonic, Manual or Remote); Concrete Conveyor System; Concrete Laser/Screed; Concrete Slipform Placer Curb & Gutter Machine; Crane (Carry Deck, Mini) or Truck Mounted Hydraulic Crane (10 Tons or Under); Crane With a Lifting Capacity of 25 Tons or Under; Forestry Equipment, Timbco, Tree Shear, Tub Grinder, Processor; Gradall (Cruz-Aire Type); Grader or Motor Patrol; Hydro-Blaster (10,000 PSI or Over); Loading Machine (Conveyor); Manhoist; Material or Stack Hoist; Mechanic or Welder; Milling Machine; Post Hole Digger or Driver; Railroad Track Rail Leveling Machine, Tie Placer, Extractor, Tamper, Stone Leveler or Rehabilitation Equipment; Roller (Over 5 Ton); Scraper (Self Propelled or Tractor Drawn) 5 cu yds or More Capacity; Shoulder Widener; Sideboom; Skid Rig; Stabilizing or Concrete Mixer (Self-Propelled or 14S or Over); Tractor (Scraper, Dozer, Pusher, Loader); Tractor or Truck Mounted Hydraulic Backhoe; Trencher (Wheel Type or Chain Type); Tube Finisher; Tugger (NOT Performing Work on the Great Lakes); Winches & A-Frames. Future Increase(s): Add \$1.60/hr on 6/3/2016.	34.69	20.38	55.07
554	Backfiller; Broom or Sweeper; Compactor (Self-Propelled or Tractor Mounted, Towed & Light Equipment); Concrete Finishing Machine (Road Type); Environmental Burner; Farm or Industrial Type Tractor; Fireman (Asphalt Plant, Pile Driver & Derrick NOT Performing Work on the Great Lakes); Forklift; Greaser; Hoist (Tugger, Automatic); Jeep Digger; Joint Sawyer (Multiple Blade); Launch (NOT Performing Work on the Great Lakes); Lift Slab Machine; Mechanical Float; Mulcher; Power Subgrader; Robotic Tool Carrier (With or Without Attachments); Roller (Rubber Tire, 5 Ton or Under); Self-Propelled Chip Spreader; Shouldering Machine; Skid Steer Loader (With or Without Attachments); Telehandler.	36.17	19.19	55.36
555	Air Compressor (&/or 400 CFM or Over); Air, Electric or Hydraulic Jacking System; Augers (Vertical & Horizontal); Automatic Belt Conveyor & Surge Bin; Boiler (Temporary Heat); Crusher, Screening or Wash Plant; Generator (&/or 150 KW or Over); Heaters (Mechanical); High Pressure Utility Locating Machine (Daylighting Machine); Mudjack; Oiler; Prestress Machine; Pug Mill; Pump (3 Inch or Over) or Well Points; Rock, Stone Breaker; Screed (Milling Machine); Stump Chipper; Tank Car Heaters; Vibratory Hammer or Extractor, Power Pack. Future Increase(s): Add \$1.60/hr on 6/3/2016.	32.62	20.38	53.00
556	Fiber Optic Cable Equipment.	29.50	0.68	30.18

***** END OF RATES *****

The documents following the Prevailing Wage Rate Determination consist of twenty pages (including this one) of various forms/documents that will be used throughout the completion of the project. This prevailing wage rate determination and its underlying legal requirements outlined in the attached documents apply for the life of this project even though work on the project continues into 2017 or beyond. The chart below lists the form number, form/document name, the party who uses the document, and the document's number of pages. If you have any questions regarding these forms please call the Prevailing Wage Office at (608)266-6861.

ERD Form Number	Form Name	Party Who Uses the Form	Pages
	July 2015 description of recent changes to Wisconsin's prevailing wage laws resulting from enactment of the 2015-17 State Budget Bill.		1
	Prevailing Wage - Public Entity Project Owners	Explanation of project owner responsibilities	2
16056	Post the White Sheet	Contracting agency	1
10908	Consolidated List of Debarred Contractors	Any party contracting someone to complete work on a prevailing wage project	4
	Prevailing Wage – Contractors	Explanation of contractor responsibilities	2
7777	Disclosure of Ownership	Contractors that meet the criteria set out in (3)(A)&(B) of the form	1
5724	Prime Contractor Affidavit of Compliance	Prime contractor files with contracting agency upon completion of the work before receiving final payment	2
10584	Agent or Subcontractor Affidavit of Compliance	Subcontractors file with their awarding contractor upon completion of their work on the project before receiving final payment	2
10880	Request to Employ Subjourneyperson	Contractors wishing to employ a subjourneyperson(s)	1
	Additional General Prevailing Wage Law Information	General information for public entity or any other interested party	3

02/16/2016

THE 2015-17 BUDGET BILL MADE SIGNIFICANT CHANGES TO WISCONSIN'S PREVAILING WAGE LAWS. HOWEVER, THOSE CHANGES DO NOT GO INTO EFFECT UNTIL JANUARY 1, 2017.

During calendar year 2016, DWD will continue to enforce prevailing wage laws for local governmental unit and state agency public works projects under current prevailing wage laws.

2015 Wisconsin Act 55 (the budget bill) repealed the state prevailing wage law for **local governmental units** such as villages, towns, cities, school districts, or sewerage districts effective January 1, 2017. However, if a local governmental unit:

- issues a Request for Bids before January 1, 2017, for a project of public works that is subject to bidding or,
- enters into a contract before January 1, 2017, for a project of public works that is not subject to bidding,

then those public works projects are subject to the current prevailing wage law (§66.0903, Wis. Stats.) through the life of the project. Projects of public works with prevailing wage project determinations issued prior to 2017 continue to be subject to the current prevailing wage law through the life of the project even though the project may have work going on in 2017 or subsequent years.

Contractors working on local governmental unit projects with prevailing wage rate determinations must continue to pay employees the appropriate prevailing wage and maintain required prevailing wage payroll records. For instance, if a contractor is working in 2018 on a public works project with a project determination issued prior to 2017, then the contractor is required to comply with the "old" prevailing wage rate law (§66.0903, Wis. Stats.). After January 1, 2017, DWD will continue to enforce prevailing wage requirements for projects with DWD prevailing wage determinations issued under the "old" prevailing wage laws (§§ 66.0903 & 103.49, Wis. Stats.).

For new public works projects starting on January 1, 2017, state prevailing wage law will only apply to **state agency** and **state highway** projects. Prevailing wage rates applicable to state agencies will be those issued by the U.S. Department of Labor under the Davis-Bacon Act, 40 U.S.C. 3142. The Wisconsin Department of Administration will enforce the new state agency prevailing wage law (§16.856, Wis. Stats.) and the Wisconsin Department of Transportation will continue to enforce prevailing wage on state highway projects (under a law renumbered as §84.062, Wis. Stats.).

PREVAILING WAGE – Public Entity Project Owners

Any public works project that has a total estimated project cost that equals or exceeds single-trade or multiple-trade project thresholds requires a prevailing wage rate determination issued by the Department of Workforce Development (DWD). Public works include erecting, constructing, remodeling, repairing, demolishing, alterations, painting and decorating projects for a local governmental unit or state agency. State law excludes minor service or maintenance work, warranty work, or work under a supply-and-installation contract. There is a statutory definition for most of these exclusions. The prevailing wage law that applies to local governmental units is §66.0903, Wis. Stats. The prevailing wage law that applies to state agencies is §103.49, Wis. Stats. The applicable administrative rules for all public entities are DWD 290 and DWD 294, Wis. Adm. Code.

Thresholds

- A “single-trade project of public works” means a project in which a single trade accounts for 85% or more of the total labor cost of the project. The single trade threshold is \$48,000.
- A “multiple-trade project of public works” means a project in which no single trade accounts for 85% or more of the total labor cost of the project.
- (a) The multiple-trade threshold is \$100,000, unless a municipality falls under the description in (b).
 - (b) The multiple-trade threshold of \$234,000 applies to public works projects erected, constructed, repaired, remodeled, or demolished by a private contractor for •a city or village with a population less than 2500 or •a town.

A local governmental unit or state agency that has a public works project that equals or exceeds the prevailing wage thresholds must do all of the following:

- Request a prevailing wage rate determination for the project from DWD at least 30 days before soliciting bids or negotiating contracts. An Application for Prevailing Wage Rate Determination is available on the DWD website: http://dwd.wisconsin.gov/er/prevailing_wage_rate/default.htm
To avoid waiting for a project determination use the on-line application system that permits the user to generate a determination immediately and save all documents in PDF form to the user’s computer. Use this project determination on line application at the following address:

http://dwd.wisconsin.gov/er/prevaling_wage_rate/pw_online_determinations.htm

- Tell potential contractors the project is subject to state prevailing wage law when soliciting bids.
- Include the prevailing wage rate determination in the construction contract, or if there is no written contract, provide a copy of the project determination to each prime contractor.
- Award contracts to contractors who do *not* appear on the “Consolidated List of Debarred Contractors.”
- Notify contractors that they are required to have a written substance abuse testing program in place that fulfills the requirements of §103.503, Wis. Stats., before commencing work on the prevailing wage project.
- Post the prevailing wage rate determination on the project site. (This document is often referred to as “the white sheet.”)
- Notify project contractors that if DWD finds that a contractor violated the prevailing wage law, DWD will assess liquidated damages of 100% of the wages owed to employees.
- Obtain an Affidavit of Compliance from each prime contractor before making final payment for the project.

If the total estimated cost of the project exceeds the prevailing wage thresholds, a local governmental unit or state agency also must obtain a prevailing wage rate determination under the following circumstances:

- when a completed facility is leased, purchased, lease-purchased or otherwise acquired by or dedicated to a public entity in lieu of the public entity contracting for the project,
- when one public entity does work for another public entity,
- when a *private* entity will construct a road, street, bridge, sanitary sewer or water main project and dedicate it to a local governmental unit or the state for its ownership or maintenance (except for some residential subdivisions).

For more information, visit the prevailing wage website: http://dwd.wisconsin.gov/er/prevaling_wage_rate/default.htm. For further assistance, call the Equal Rights Division at 608-266-6861 and ask for prevailing wage.

POST THE WHITE SHEET

As the public entity receiving this prevailing wage rate determination, YOU ARE REQUIRED by law to post the prevailing wage rate determination (i.e., white sheet) in at least one conspicuous and easily accessible place on the project site that is available to all construction workers. The white sheet must remain posted from the onset of the project until all construction labor on the project has been completed.

[See, Wis. Admin. Code §DWD 290.12(1)]

Posting the white sheet inside the general contractor's trailer does not meet this requirement. That placement is not available/accessible to all workers and is not a location over which you have control.

If you have questions about posting, please call (608)266-6861 and ask for prevailing wage intake.

State of Wisconsin - Department of Workforce Development

This list has been prepared in accordance with the provisions of §§66.0903(12) and 103.49(7), Wis. Stats., and Chapter DWD 294 of the Wisconsin Administrative Code. All contractors on this list were found to have committed a "debarable offense" related to certain labor standard provisions determined or established for a state or local public works project. No state agency, local governmental unit or owner or developer may knowingly solicit bids from, negotiate with or award any contracts to or approve or allow any subcontracts with a debarred contractor, including all divisions, affiliates or other organizational elements of such contractor that are engaged in construction business activities, until the debarment is terminated. The name of each debarred contractor must remain on this list for a period of three (3) years from the termination date indicated below. The contractor is, however, only "debarred" from the "effective date" through the "termination date" indicated for that contractor. Questions regarding this list should be addressed to Jim Chiolino, Equal Rights Division, P. O. Box 8928, Madison, WI 53708 or call (608) 266-3345. Deaf, hearing or speech-impaired callers may contact the department by calling its TDD number (608) 264-8752.

<u>Name of Contractor</u>	<u>Address</u>	<u>Effective Date</u>	<u>Termination Date</u>	<u>Cause Code</u>	<u>Date of Violation(s)</u>	<u>Limitations/Deviations</u>
A-1 Duran Roofing & Insulation Services, Inc.	3700 N Fratney St Milwaukee, WI 53212	11/1/14	10/31/17	1, 2 and 4	2011- 2012	None
	or 8095 NW 64 th St Miami, FL 33166					
Abel, Mike	See, Abel Electric, Inc					
Abel Electric, Inc	3385 Belmar Rd Green Bay, WI 54313	9/1/12	8/31/15	1	2011	None
Alpha Electric, LLC	350 Business Park Dr Sun Prairie, WI 53590	8/1/15	7/31/18	4	2014	None
Arnie Christiansen Mason Contractors, LLC	2304 65 th Dr Franksville, WI 53126	9/1/14	8/31/16	1, 2 and 4	2011	None
Atkins, Scott	See, Freedom Insulation, Inc					
Bickel, Matthew	See, Peshtigo Asphalt, Inc					
Boecker, Roger	See, R-Way Pumping, Inc					
Brechtl, Mark G	See, Ecodec, Inc					

<u>Name of Contractor</u>	<u>Address</u>	<u>Effective Date</u>	<u>Termination Date</u>	<u>Cause Code</u>	<u>Date of Violation(s)</u>	<u>Limitations/Deviations</u>
Cargill Heating and Air Conditioning Company, Inc	3049 Edgewater La La Crosse, WI 54603	3/1/14	2/28/17	1 and 2	2011	None
Castlerock Commercial Construction, Inc	PO Box 11699 Milwaukee, WI 53211-0699	2/1/12	1/31/15	1, 2 and 4	2009 & 2010	None
Christiansen, Andy	See, Arnie Christiansen Mason Contractors, LLC					
Christiansen, Arnold	See, Arnie Christiansen Mason Contractors, LLC					
Darnick, Gregory L	See, Darnick Trucking, LLC					
Darnick Trucking, LLC	W914 County Rd V Berlin, WI 54923	11/1/14	10/31/15	1, 2 and 4	2012 & 2013	None
Dem/Ex Group, Inc	805 S Adams St Manito, IL 61546	12/1/11	11/30/14	1 and 2	2010	None
Duran, Bernardo	See, A-1 Duran Roofing & Insulation Services and RRS2 Inc					
Ecodec, Inc	5106 Wintergreen Dr Madison, WI 53704	10/1/14	9/30/17	1	2011 & 2012	None
Fisher, Ed &/or Fisher, Rhonda	See, Dem/Ex Group, Inc					
Freedom Insulation, Inc	117925 219th Ave Chippewa Falls, WI 54729	9/1/11	8/31/14	1	2008- 2010	None
Froode, Kathleen M	See, Masonry Specialists II, LLC					
Galstad, Michael E (aka Michael Earl Galstad)	See, Cargill Heating and Air Conditioning Company, Inc					

<u>Name of Contractor</u>	<u>Address</u>	<u>Effective Date</u>	<u>Termination Date</u>	<u>Cause Code</u>	<u>Date of Violation(s)</u>	<u>Limitations/Deviations</u>
Gjolaj, Ded	See, Horizon Bros Painting Corp					
Grade A Construction, Inc	157 Enterprise Rd Delafield, WI 53018	1/1/16	12/31/19	1, 2 and 4	2014	None
Horizon Bros Painting Corp	1053 Kendra La Howell, MI 48843	10/1/14	9/30/16	4	2012	None
JT Roofing, Inc	350 Tower Dr Saukville, WI 53080	6/1/12	5/31/15	1, 2 and 4	2007 & 2008	None
Jinkins, Richard	See, Castlerock Commercial Construction, Inc					
John's Concrete	See, Wagner Companies, Inc, dba John's Concrete					
Kott, Joseph J	See, Alpha Electric, LLC					
Masonry Specialists II, LLC	5109 Briarwood Ct Racine, WI 53402	8/1/15	7/31/18	4	2014	None
Mid-W Enterprises, Inc	1730 22 nd Avenue Kenosha, WI 53140	6/1/15	5/31/17	1, 2 and 4	2013	None
Midwest Construction Co, Inc	See, Mid-W Enterprises, Inc					
Oden, Cassie	See, A-1 Duran Roofing & Insulation Services and RRS2 Inc					
Ofstie, Darin	See, Precision Excavating and Grading, LLC					
Peret, Robert	See, A-1 Duran Roofing & Insulation Services and RRS2 Inc					

<u>Name of Contractor</u>	<u>Address</u>	<u>Effective Date</u>	<u>Termination Date</u>	<u>Cause Code</u>	<u>Date of Violation(s)</u>	<u>Limitations/Deviations</u>
Peshtigo Asphalt, Inc	W3895 Track La Peshtigo, WI 54157	3/1/16	2/28/17	1	2013- 2014	None
Precision Excavating and Grading, LLC or Precision Excavating Enterprises, LLC	2104 Pierce Saint Croix Rd Baldwin, WI 54002	5/1/11	4/30/14	1, 2 and 4	2006- 2008	None
R-Way Pumping, Inc	3023 Lake Maria Rd Freeport, MN 56331	3/1/12	2/28/15	1, 2 and 4	2008	None
RRS2 Inc.	133 N Jackson St, #427 Milwaukee, WI 53202 or 1313 N Franklin Pl, #805 Milwaukee, WI 53202	11/1/14	10/31/17	1, 2 and 4	2011- 2012	None
Thull, Gerald T	See, JT Roofing, Inc					
Ventura, Robert	See, Mid-W Enterprises, Inc					
Wagner, Cory L	See, Wagner Companies, Inc					
Wagner Companies, Inc, dba John's Concrete	2063 Georgia Ave Racine, WI 53404	8/1/15	7/31/18	1	2013	None
Yaresh, Kathleen R	See, Grade A Construction, Inc					

Cause Code: 1 = Failure to Pay Straight Time 2 = Failure to Pay Overtime 3 = Kickback 4 = Payroll Records.

PREVAILING WAGE – Contractors

Any public works project that has a total estimated project cost that equals or exceeds prevailing wage project thresholds requires a prevailing wage rate determination issued by the Department of Workforce Development (DWD). Public works include erecting, constructing, remodeling, repairing, demolishing, alterations, painting and decorating projects for a local governmental unit or state agency. State law excludes minor service or maintenance work, warranty work, or work under a supply-and-installation contract. There is a statutory definition for most of these exclusions. The prevailing wage laws that apply to local governmental units and their contractors are §§66.0903 and 103.503, Wis. Stats. The prevailing wage laws that apply to state agencies and their contractors are §§103.49 and 103.503, Wis. Stats. The applicable administrative rules for all prevailing wage projects are DWD 290 and DWD 294, Wis. Adm. Code. These laws include provisions that apply to all contractors and subcontractors working on prevailing wage projects.

Any contractor or subcontractor working on a local governmental unit or state agency's public works project that equals or exceeds current prevailing wage project thresholds must do all of the following:

- Receive and review the project's prevailing wage rate determination (i.e., white sheet).
- Tell subcontractors the project is subject to state prevailing wage law and include the prevailing wage rate determination in the construction contract, or if there is no written contract, provide a copy of the project determination to each subcontractor.
- Hire subcontractors who do *not* appear on the "Consolidated List of Debarred Contractors."
- Have a written substance abuse testing program in place that fulfills the requirements of §103.503, Wis. Stats., before commencing work on the project.

- Notify subcontractors that if DWD finds that a contractor or subcontractor violated the prevailing wage law, DWD will assess liquidated damages of 100% of the wages owed to employees.
- Apply to DWD for subjourney wage rates prior to employing these individuals on the project.
- Receive and retain a completed Affidavit of Compliance from each subcontractor brought on to the project before providing final payment to those subcontractors.
- Submit a completed Affidavit of Compliance to the contractor who brought the subcontractor on to the project before receiving final payment for the project.
- Maintain payroll records for 3 years that comply with §§66.0903(10)(a) or 103.49(5)(a), Stats. and DWD 274.06.
- Respond to requests from DWD or the project owner to provide payroll records and/or respond to prevailing wage complaints filed by employees or third parties.

For more information, visit the prevailing wage website: http://dwd.wisconsin.gov/er/prevailing_wage_rate/default.htm. For further assistance, call the Equal Rights Division at 608-266-6861 and ask for prevailing wage.

Disclosure of Ownership

The statutory authority for the use of this form is prescribed in Sections 66.0903(12)(d), 66.0904(10)(d) and 103.49(7)(d), Wisconsin Statutes.

The use of this form is mandatory. The penalty for failing to complete this form is prescribed in Section 103.005(12), Wisconsin Statutes.

Personal information you provide may be used for secondary purposes [Privacy Law, s. 15.04(1) (m), Wisconsin Statutes].

- (1) On the date a contractor submits a bid to or completes negotiations with a state agency, local governmental unit, or developer, investor or owner on a project subject to Section 66.0903, 66.0904 or 103.49, Wisconsin Statutes, the contractor shall disclose to such state agency, local governmental unit, or developer, investor or owner, the name of any "other construction business," which the contractor, or a shareholder, officer or partner of the contractor, owns or has owned within the preceding three (3) years.
- (2) The term "other construction business" means any business engaged in the erection, construction, remodeling, repairing, demolition, altering or painting and decorating of buildings, structures or facilities. It also means any business engaged in supplying mineral aggregate, or hauling excavated material or spoil as provided by Sections 66.0903(3), 66.0904(2), 103.49(2) and 103.50(2), Wisconsin Statutes.
- (3) This form must ONLY be filed, with the state agency project owner, local governmental unit project owner, or developer, investor or owner of a publicly funded private construction project that will be awarding the contract, if **both (A) and (B) are met.**
 - (A) The contractor, or a shareholder, officer or partner of the contractor:
 - (1) Owns at least a 25% interest in the "other construction business," indicated below, on the date the contractor submits a bid or completes negotiations; or
 - (2) Has owned at least a 25% interest in the "other construction business" at any time within the preceding three (3) years.
 - (B) The Wisconsin Department of Workforce Development (DWD) has determined that the "other construction business" has failed to pay the prevailing wage rate or time and one-half the required hourly basic rate of pay, for hours worked in excess of the prevailing hours of labor, to any employee at any time within the preceding three (3) years.

Other Construction Business

Business Name			
Street Address or P O Box	City	State	Zip Code
Business Name			
Street Address or P O Box	City	State	Zip Code
Business Name			
Street Address or P O Box	City	State	Zip Code
Business Name			
Street Address or P O Box	City	State	Zip Code

I hereby state under penalty of perjury that the information, contained in this document, is true and accurate according to my knowledge and belief.

Print the Name of Authorized Officer			
Authorized Officer Signature	Date Signed		
Corporation, Partnership or Sole Proprietorship Name			
Street Address or P O Box	City	State	Zip Code

If you have any questions call (608) 266-6861

List of Agents and Subcontractors

Name			Name		
Street Address			Street Address		
City	State	Zip Code	City	State	Zip Code
Telephone Number			Telephone Number		
Name			Name		
Street Address			Street Address		
City	State	Zip Code	City	State	Zip Code
Telephone Number			Telephone Number		
Name			Name		
Street Address			Street Address		
City	State	Zip Code	City	State	Zip Code
Telephone Number			Telephone Number		
Name			Name		
Street Address			Street Address		
City	State	Zip Code	City	State	Zip Code
Telephone Number			Telephone Number		
Name			Name		
Street Address			Street Address		
City	State	Zip Code	City	State	Zip Code
Telephone Number			Telephone Number		
Name			Name		
Street Address			Street Address		
City	State	Zip Code	City	State	Zip Code
Telephone Number			Telephone Number		

If you have any questions call (608) 266-6861

Agent or Subcontractor Affidavit of Compliance With Prevailing Wage Rate Determination

Authorization for this form is provided under Sections 66.0903(9)(b), 66.0904(7)(b) and 103.49(4r)(9b), Wisconsin Statutes. The use of this form is mandatory. The penalty for failing to complete this form is prescribed in Section 103.005(12), Wisconsin Statutes.

Personal information you provide may be used for secondary purposes [Privacy Law, Section 15.04(1)(m), Wisconsin Statutes].

This form must **ONLY** be filed with the **Awarding Contractor** indicated below.

State Of _____))SS County Of _____)	Project Name		
	DWD Determination Number	Project Number (if applicable)	
	Date Determination Issued	Date of Subcontract	
	Awarding Contractor		
	Date Work Completed		

After being duly sworn, the person whose name and signature appears below hereby states under penalty of perjury that

- **I am** the duly authorized officer of the corporation, partnership, sole proprietorship or business indicated below. We have recently completed all of the work required under the terms and conditions of a subcontract with the above-named awarding contractor. We make this affidavit in accordance with the requirements set forth in Section 66.0903(9)(b), 66.0904(7)(b) or 103.49(4r)(b), Wisconsin Statutes and Chapter DWD 290 of the Wisconsin Administrative Code in order to obtain FINAL PAYMENT from such awarding contractor.
- **I have** fully complied with the entire wage and hour requirements applicable to this project, including all of the requirements set forth in the prevailing wage rate determination indicated above which was issued for such project by the Department of Workforce Development on the date indicated above.
- **I have** received the required affidavit of compliance from each of my agents and subcontractors that performed work on this project and have listed each of their names and addresses on page 2 of this affidavit.
- **I have** full and accurate records that clearly indicate the name and trade or occupation of every worker(s) that I employed on this project, including an accurate record of the hours worked and actual wages paid to such worker(s).
- **I will** retain the records and affidavit(s) described above and make them available for inspection for a period of at least three (3) years from the completion date indicated above at the address indicated below and shall not remove such records or affidavit(s) without prior notification to the awarding contractor.

Name of Corporation, Partnership, Sole Proprietorship, Business, State Agency or Local Governmental Unit				
Street Address or PO Box	City	State	Zip Code	Telephone Number ()
Print Name of Authorized Officer			Date Signed	
Authorized Officer Signature				

List of Agents and Subcontractors

Name			Name		
Street Address			Street Address		
City	State	Zip Code	City	State	Zip Code
Telephone Number ()			Telephone Number ()		
Name			Name		
Street Address			Street Address		
City	State	Zip Code	City	State	Zip Code
Telephone Number ()			Telephone Number ()		
Name			Name		
Street Address			Street Address		
City	State	Zip Code	City	State	Zip Code
Telephone Number ()			Telephone Number ()		
Name			Name		
Street Address			Street Address		
City	State	Zip Code	City	State	Zip Code
Telephone Number ()			Telephone Number ()		
Name			Name		
Street Address			Street Address		
City	State	Zip Code	City	State	Zip Code
Telephone Number ()			Telephone Number ()		
Name			Name		
Street Address			Street Address		
City	State	Zip Code	City	State	Zip Code
Telephone Number ()			Telephone Number ()		
Name			Name		
Street Address			Street Address		
City	State	Zip Code	City	State	Zip Code
Telephone Number ()			Telephone Number ()		

If you have any questions call (608) 266-6861

Request to Employ Subjourneyperson

The use of this form is mandatory. The penalty for failing to complete this form is prescribed in Section 103.005(12), Wisconsin Statutes. Personal information you provide may be used for secondary purposes (Privacy Law, s. 15.04(1)(m), Wisconsin Statutes).

The employer indicated below requests that the Department of Workforce Development (DWD) determine the prevailing wage rate(s) and related qualifications to enable such employer to use a subjourneyperson(s) on the following prevailing wage project, in accordance with the provisions of Section DWD 290.025, Wisconsin Administrative Code.

1. Name of Project Appearing on the Project Determination			
County	City, Village or Town		
DWD Project Determination Number	Project Number (if applicable)		
2. Job Classification(s) for which you request a subjourney rate (i.e., carpenter, electrician, plumber, etc.)			
a.			
c.			
3. Employer Name (Print)			
Address		City	State
Telephone Number ()		Zip Code	
Requester Title		Requester Name (Print)	
Email address (if you prefer to receive your response via email)		Fax Number (if you prefer to receive your response via fax) ()	
Requester Signature			Date Signed

READ CAREFULLY: I understand that this request is ONLY applicable to the project and job classification(s) listed above and that subjourney employees primarily work under the direction of and assist a skilled trade employee by frequently using the tools of a skilled trade and will NOT regularly perform the duties of a general laborer, heavy equipment operator or truck driver. If the subjourney employee regularly performs the work of a different trade or occupation, he/she will be compensated for such work at the applicable journeyperson prevailing wage rate. I agree to compensate subjourney employees in strict accordance with the directions received from the DWD.

MAIL the completed request to:
 EQUAL RIGHTS DIVISION, LABOR STANDARDS BUREAU
 PO BOX 8928, MADISON WI 53708
OR
 FAX the completed request to: (608) 267-4592 / **DO NOT e-mail your request.**
 Call (608) 266-6861 for assistance in completing this form.

ADDITIONAL GENERAL PREVAILING WAGE LAW INFORMATION

(This document updated July 2015)

NOTE: Recent prevailing wage law changes enacted by the 2015-17 Budget Bill (2015 Wisconsin Act 55) do not go into effect until calendar year 2017.

For prevailing wage laws and frequently asked questions, refer to the prevailing wage website at:
http://dwd.wisconsin.gov/er/prevailing_wage_rate/default.htm

Topic	Who's affected?	Brief description of requirement under §66.0903 or §103.49
Non-applicability	All public entities	Prevailing wage rates do not apply to minor service or maintenance work, warranty work, or work under a supply and installation contract.
Non-applicability: Minor service or maintenance work	Local governmental units & Contractors	Minor service or maintenance work means a project of public works that is limited to <ul style="list-style-type: none"> • minor crack filling, chip or slurry sealing, or other minor pavement patching, not including overlays, that has a projected life span of no longer than 5 years or that is performed for a TOWN and is not funded under §86.31, regardless of projected life span; • the depositing of gravel on an existing gravel road applied solely to maintain the road; • road shoulder maintenance; • cleaning of drainage or sewer ditches or structures; or • any other limited, minor work on public facilities or equipment that is routinely performed to prevent breakdown or deterioration.
Non-applicability: Minor service or maintenance work	State agencies	Minor service or maintenance work means a project of public works that is limited to <ul style="list-style-type: none"> • minor crack filling, chip or slurry sealing, or other minor pavement patching, not including overlays, that has a projected life span of no longer than 5 years; • cleaning of drainage or sewer ditches or structures; or • any other limited, minor work on public facilities or equipment that is routinely performed to prevent breakdown or deterioration.
Non-applicability: Supply & installation contract	All public entities	Supply and installation contract means a contract under which the material is installed by means of simple fasteners or connectors such as screws or nuts and bolts and no other work is performed on the site of the project of public works, and the total labor cost to install the material does not exceed 20 percent of the total cost of the contract.
Non-applicability: Work which a contractor or individual donates to a public entity	All public entities	Prevailing wage laws §§66.0903 & 103.49, Stats., do not apply to work performed on a project of public works for which the local governmental unit or the state or the state agency contracting for the project is not required to compensate any contractor, subcontractor, contractor's or subcontractor's agent, or individual for performing the work.

Topic	Who's affected?	Brief description of requirement under §66.0903 or §103.49
Non-applicability: Residential	All public entities	A prevailing wage rate determination is not required for the erection, construction, repair, remodeling, or demolition of a residential property containing 2 dwelling units or less.
Non-applicability: Residential subdivision infrastructure	All public entities	A prevailing wage rate determination is not required for a road, street, bridge, sanitary sewer, or water main project that is a part of a development in which at least 90 percent of the lots contain or will contain 2 dwelling units or less, as determined by the local governmental unit at the time of approval of the development, and that, on completion, is acquired by, or dedicated to, a local governmental unit (including under §236.13(2), Stats.), or the state, for ownership or maintenance by the local governmental unit or the state.
Electronic certified payroll record	Contractors	The requirement that every contractor on a prevailing wage project submit to DWD monthly a certified record of employees who worked on the project and that DWD post these certified records on its Internet website was discontinued effective July 1, 2011. Contractors are still required to maintain payroll records and provide them upon request from DWD &/or the project owner.
Payroll record inspection request by any person	Contractors & Complainants	Any person may request DWD to inspect the payroll records of any contractor working on a prevailing wage project. On receipt of such a request, the contractor must submit to DWD a certified record of its payroll records, other than personally identifiable information relating to an employee of the contractor, for no longer than a 4-week period. DWD may request records from a contractor under this provision no more than once per calendar quarter for each project of public works on which the contractor is performing work. The department may not charge a requester a fee for obtaining that information. DWD must make these certified records available for public inspection.
Statewide uniformity	Local governmental units	A local governmental unit may not enact & administer a prevailing wage ordinance/provision for public works or publicly funded private construction projects. Any extant laws to that effect are void.
Substance Abuse Testing	Contractors & Workers	Before commencing work on a prevailing wage project, a contractor must have a written substance abuse testing program in place that complies with §103.503, Wis. Stats. No employee may use, possess, attempt to possess, distribute, deliver, or be under the influence of a drug or under the influence of alcohol while performing work on a prevailing wage project.

Topic	Who's affected	Brief description of requirement under §66.0903 or §103.49
Covered employees	Truck drivers & Other workers & Contractors	<p>A laborer, worker, mechanic, or truck driver who is employed to process, manufacture, pick up, or deliver materials or products from a commercial establishment that has a fixed place of business from which the establishment supplies processed or manufactured materials or products or from a facility that is not dedicated exclusively, or nearly so, to a project of public works is NOT entitled to receive the prevailing wage rate UNLESS any of the following applies:</p> <ol style="list-style-type: none"> 1) the laborer, worker, mechanic, or truck driver is employed to go to the source of mineral aggregate such as sand, gravel, or stone and deliver that mineral aggregate to the site of a project of public works by depositing the material directly in final place, from the transporting vehicle or through spreaders from the transporting vehicle. 2) the laborer, worker, mechanic, or truck driver is employed to go to the site of a project of public works, pick up excavated material or spoil from the site of the project, and transport that excavated material or spoil away from the site of the project.

SECTION 01 00 00
BASIC REQUIREMENTS

PART 1 GENERAL

1.1 SECTION SUMMARY

- A. Section Includes:
1. Section Summary
 2. Summary of the Work
 3. Contractor Use of Premises
 4. Applications for Payment
 5. Change Procedures
 6. Alternates
 7. Coordination
 8. Cutting and Patching
 9. Conferences
 10. Progress Meetings
 11. Submittal Procedures
 12. Proposed Products List
 13. Shop Drawings
 14. Product Data
 15. Samples
 16. Manufacturers' Instructions
 17. Manufacturers' Certificates
 18. Quality Assurance / Quality Control of Installation
 19. References
 20. Interior Enclosures
 21. Protection of Installed Work
 22. Parking
 23. Staging Areas
 24. Occupancy During Construction and Conduct of Work
 25. Protection
 26. Progress Cleaning
 27. Products
 28. Transportation, Handling, Storage and Protection
 29. Product Options
 30. Substitutions
 31. Starting Systems
 32. Demonstration and Instructions
 33. Contract Closeout Procedures
 34. Final Cleaning
 35. Adjusting
 36. Operation and Maintenance Data
 37. Spare Parts and Maintenance Materials
 38. As-Built and Record Drawings and Specifications

1.2 SUMMARY OF THE WORK

- A. Project Description: Perform the Work as specified and detailed in Construction Documents package. Contractor to provide construction services for a new pre-engineered metal building that is approximately 40' by 120' in size, as outlined in the project drawings and construction documents.
- B. Work by Owner: Not applicable.
- C. Permits: Prior to commencement of the Work, Contractor to secure any and all necessary permits for completion of the Work and facility occupancy.
- D. Diggers Hotline:
 - 1. It is General Contractor's responsibility to contact Diggers Hotline to have all utility locations marked prior to excavation and planning an excavation in a timely manner so as not to delay the Work.
 - 2. Diggers Hotline shall also be used to obtain information on safe working clearances from overhead lines.
 - 3. Completely comply with all requirements of each affected utility company.
 - 4. It is General Contractor's responsibility to contact & hire private utility locating services if necessary.

1.3 CONTRACTOR USE OF PREMISES

- A. Limit use of premises to allow work by Contractors or Subcontractors and access by Owner.

1.4 APPLICATIONS FOR PAYMENT

- A. Submit two (2) original copies with "wet" signatures of each application on AIA G702™ and G703™ forms or approved contractors invoice form.
- B. Content and Format: Utilize Schedule of Values for listing items in Application for Payment.
- C. Payment Period: Monthly.
- D. Submit Applications for Payment to Architect / Engineer for initial approval. Architect / Engineer will forward approved copies to Owner who will also approve & process for payment.

1.5 CHANGE PROCEDURES

- A. Change Order Forms: Dane County Contract Change Order, Form 014-32-20 (latest issue)
- B. Contractor's costs for Products, delivery, installation, labor, insurance, payroll, taxes, bonding, equipment rental, overhead and profit will be included in Change Orders authorizing expenditure of funds from contingency allowance.

1.6 ALTERNATES

- A. Alternates quoted on Bid Form shall be reviewed and accepted or rejected at Owner's option.
- B. Coordinate related work and modify surrounding work as required.
- C. Schedule of Alternates: there are no alternates proposed for this project.

1.7 COORDINATION

- A. Coordinate scheduling, submittals, and work of various sections of Specifications to assure efficient and orderly sequence of installation of interdependent construction elements.
- B. Verify utility requirement characteristics of operating equipment are compatible with building utilities.
- C. Coordinate space requirements and installation of mechanical and electrical work that are indicated diagrammatically on Drawings.
- D. Public Works Project Engineer may choose to videotape site or workers as the Work progresses.

1.8 CUTTING AND PATCHING

- A. Employ a skilled and experienced installer to perform cutting and patching new work; restore work with new Products.
- B. Submit written request in advance of cutting or altering structural or building enclosure elements.
- C. Fit work tight to adjacent elements. Maintain integrity of wall, ceiling, or floor construction; completely seal voids.
- D. Refinish surfaces to match adjacent finishes.

1.9 CONFERENCES

- A. There will be pre-bid conference for this project; see Instructions to Bidders.
- B. Owner will schedule a pre-construction conference after Award of Contract for all affected parties.
- C. Contractor shall submit Construction Schedule at pre-construction meeting.
- D. When required in individual Specification section, convene a pre-installation conference at project site prior to commencing work of Section.

1.10 PROGRESS MEETINGS

- A. Owner shall schedule and administer meetings throughout progress of the Work at minimum of one (1) per week.
- B. Owner shall preside at meetings, record minutes, and distribute copies within two (2) business days to those affected by decisions made.

1.11 SUBMITTAL PROCEDURES

- A. Submittal form to identify Project, Contractor, Subcontractor or supplier; and pertinent Construction Documents references.
- B. Apply Contractor's stamp, signed or initialed, certifying that review, verification of Products required, field dimensions, adjacent construction work, and coordination of information is in accordance with requirements of the Work and Construction Documents.
- C. Identify variations from Construction Documents and Product or system limitations that may be detrimental to successful performance of completing the Work.
- D. Revise and resubmit submittals as required; identify all changes made since previous submittal.

1.12 PROPOSED PRODUCTS LIST

- A. Within fifteen (15) business days after date of Award of Contract, submit complete list of major Products proposed for use, with name of manufacturer, trade name, and model number of each Product.

1.13 SHOP DRAWINGS

- A. Submit number of copies that Contractor requires, plus three (3) copies that shall be retained by Public Works Project Manager.

1.14 PRODUCT DATA

- A. Submit number of copies that Contractor requires, plus two (2) copies that shall be retained by Public Works Project Manager.
- B. Mark each copy to identify applicable products, models, options, and other data. Supplement manufacturer's standard data to provide information unique to this Project.

1.15 SAMPLES

- A. Submit samples to illustrate functional and aesthetic characteristics of Product.
- B. Submit samples of finishes from full range of manufacturers' standard colors, textures, and patterns for Public Works Project Manager's selection.

1.16 MANUFACTURERS' INSTRUCTIONS

- A. When specified in individual Specification sections, submit manufacturers' printed instructions for delivery, storage, assembly, installation, start-up, adjusting, and finishing, in quantities specified for Product Data.

1.17 MANUFACTURERS' CERTIFICATES

- A. When specified in individual Specification sections, submit manufacturers' certificate to Public Works Project Manager for review, in quantities specified for Product Data.
- B. Indicate material or Product conforms to or exceeds specified requirements. Submit supporting reference data, affidavits, and certifications as appropriate.

1.18 QUALITY ASSURANCE / QUALITY CONTROL OF INSTALLATION

- A. Monitor quality control over suppliers, manufacturers, Products, services, site conditions, and workmanship, to produce work of specified quality.
- B. Comply fully with manufacturers' instructions.
- C. Comply with specified standards as minimum quality for the Work except when more stringent tolerances, codes, or specified requirements indicate higher standards or more precise workmanship.

1.19 REFERENCES

- A. Conform to reference standard by date of issue current as of date for receiving bids.
- B. Should specified reference standard conflict with Construction Documents, request clarification from Public Works Project Manager before proceeding.

1.20 INTERIOR ENCLOSURES

- A. Provide temporary partitions as required to separate work areas from Owner occupied areas, to prevent distribution of dust and moisture into Owner occupied areas, and to prevent damage to existing materials and equipment.

1.21 PROTECTION OF INSTALLED WORK

- A. Protect installed work and provide special protection where specified in individual Specification sections.

1.22 PARKING

- A. Arrange for temporary parking areas to accommodate construction personnel. Parking shall be available at the Work site.

1.23 STAGING AREAS

- A. Coordinate staging areas with Public Works Project Manager prior to starting the Work.
- B. On-site space for use as staging areas and storage of materials is limited and will be apportioned among various Contractors as their needs dictate with due regard for storage requirements of each Contractor. Each Contractor shall be responsible for safety of equipment and materials that are stored on site.

1.24 OCCUPANCY DURING CONSTRUCTION AND CONDUCT OF WORK

- A. Areas of existing facility will be occupied during period when the Work is in progress. Work may be done during normal business hours (8:00 am to 4:30 pm), but confer with Owner, schedule work and store materials so as to interfere as little as possible with normal use of premises. Notify Owner when coring or similar noise making work is to be done and obtain Owner's written approval of schedule. If schedule is not convenient for Owner, reschedule and resubmit new times for Owner approval. Coring of floor along with other noisy work may have to be done on second and third shifts.
- B. Work shall be done and temporary facilities furnished so as not to interfere with access to any occupied area and so as to cause least possible interference with normal operation of facility or any essential service thereof.
- C. Contractor shall, at all times, provide approved, safe walkways and facility entrances for use by Owner, employees and public.
- D. Contractor shall provide adequate protection for all parts of facility, its contents and occupants wherever the Work under this Contract is to be performed.
- E. Contractor [is, is not] responsible for providing & maintaining temporary toilet facilities.
- F. Each Contractor shall arrange with Owner to make necessary alterations, do new work, make connections to all utilities, etc., at such times as will not cause interruption of utility services to facility. Contractor doing this work shall protect, cap, cut off and / or replace and relocate existing pipes, electrical work and other active utilities encountered which may interfere with new construction work.
- G. New work in extension of existing work shall correspond in all respects with that to which it connects or similar existing work unless otherwise indicated or specified.
 - 1. Existing work shall be cut, altered, removed or replaced as necessary for performance of Contract obligations.
 - 2. Work remaining in place, damaged or defaced by reason of work done under this Contract shall be restored equal to its condition at time of Award of Contract.
 - 3. If removal of work exposes discolored or unfinished surfaces or work out of alignment, such surfaces shall be refinished or materials replaced as necessary to make continuous work uniform and harmonious.

1.25 PROTECTION

- A. Contractor shall protect from injury all trees, shrubs, hedges, walks and driveways and pay for any damage to same resulting from insufficient or improper protection.
- B. Contractor shall provide and maintain barricades & signage to prohibit public access to construction site.

1.26 PROGRESS CLEANING

- A. Maintain areas free of waste materials, debris, and rubbish. Maintain site in clean and orderly condition.

1.27 PRODUCTS

- A. Products: Means new material, machinery, components, equipment, fixtures, and systems forming the Work, but does not include machinery and equipment used for preparation, fabrication, conveying and erection of the Work. Products may also include existing materials or components specifically identified for reuse.
- B. Do not use materials and equipment removed from existing premises, except as specifically identified or allowed by Construction Documents.

1.28 TRANSPORTATION, HANDLING, STORAGE AND PROTECTION

- A. Transport, handle, store and protect Products in accordance with manufacturer's instructions.

1.29 PRODUCT OPTIONS

- A. Where definite material is specified, it is not intentional to discriminate against "equal" product made by another manufacturer. Intention is to set definite standard of material quality. Should bidder choose to bid materials other than those specified, bidder shall submit said materials specifications to Public Works Project Manager for approval at least seven (7) business days prior to Bid Due Date.
- B. Products and materials that are not specified, but have been approved for use by Public Works Project Manager shall be identified in addenda to all bidding contractors.
- C. Requests for material or product substitutions submitted after Bid Due Date may be considered. Owner reserves right to approve or reject substitutions based on Specification requirements and intended use.

1.30 SUBSTITUTIONS

- A. Public Works Project Manager shall consider requests for Substitutions only within fifteen (15) calendar days after date of Public Works Construction Contract.

- B. Document each request with complete data substantiating compliance of proposed Substitution with Construction Documents.
- C. Submit three (3) copies of requests for Substitution for consideration. Limit each request to one (1) proposed Substitution.
- D. Substitutions shall not change contract price established at Bid Due Date.

1.31 STARTING SYSTEMS

- A. Provide written notification prior to start-up of each equipment item or system.
- B. Ensure that each piece of equipment or system is ready for operation.
- C. Execute start-up under supervision of responsible persons in accordance with manufacturers' instructions.
- D. Submit written report that equipment or system has been properly installed and is functioning correctly.

1.32 DEMONSTRATION AND INSTRUCTIONS

- A. Demonstrate operation and maintenance of Products to Owner's personnel prior to date of final inspection.
- B. Demonstrate start-up, operation, control, adjustment, trouble-shooting, servicing, maintenance, and shutdown of each item of equipment at agreed-upon times, at designated location.
- C. Owner may choose to videotape demonstration session; demonstration and demonstrator shall be to level of satisfaction of Owner.

1.33 CONTRACT CLOSEOUT PROCEDURES

- A. Submit written certification that Construction Documents have been reviewed, the Work has been inspected, and the Work is complete in accordance with Construction Documents and ready for Public Works Project Manager's inspection.
- B. Submit final Application for Payment identifying total adjusted Contract Sum / Price, previous payments, and amount remaining due.

1.34 FINAL CLEANING

- A. Execute final cleaning prior to final inspection.
- B. Clean interior and exterior surfaces exposed to view.
- C. Remove waste and surplus materials, rubbish, and construction facilities from site.

1.35 ADJUSTING

- A. Adjust operating Products and equipment to ensure smooth and unhindered operation.

1.36 OPERATION AND MAINTENANCE MANUAL

- A. Provide operation and maintenance manual for all mechanical and electrical equipment and systems supplied and installed in the Work.

1.37 SPARE PARTS AND MAINTENANCE MATERIALS

- A. Provide Products, spare parts, maintenance and extra materials in quantities specified in individual Specification Sections.
- B. Deliver to the Work site and place in location as directed.

1.38 AS-BUILT AND RECORD DRAWINGS AND SPECIFICATIONS

- A. Contractor-produced Drawings and Specifications shall remain property of Contractor whether Project for which they are made is executed or not. Contractor shall furnish Public Works Project Manager with original marked up redlines of Construction Documents' drawings and specifications that shall include all Addendums, Change Orders, Construction Bulletins, on-site changes, field corrections, etc. These are project As-Built Drawings & Specifications.

PART 2 PRODUCTS

Not Used.

PART 3 EXECUTION

Not Used.

END OF SECTION

SECTION 01 74 19

CONSTRUCTION WASTE MANAGEMENT, DISPOSAL & RECYCLING

PART 1 GENERAL

1.1 SUMMARY

- A. Section Includes:
 - 1. Summary
 - 2. Waste Management Goals
 - 3. Construction and / or Demolition Waste Management
 - 4. Waste Management Plan
 - 5. Reuse
 - 6. Recycling
 - 7. Materials Sorting and Storage On Site
 - 8. Lists of Recycling Facilities Processors and Haulers
 - 9. Waste Management Plan Form

- B. Related Sections:
 - 1. Section 01 00 00 - Basic Requirements

1.2 WASTE MANAGEMENT GOALS

- A. Dane County requires that as many waste materials as possible produced as result of this project be salvaged, reused or recycled in order to minimize impact of construction waste on landfills and to minimize expenditure of energy and cost in fabricating new materials. Additional information may be found in Dane County Green Building Policy, Resolution 299, 1999-2000.

1.3 CONSTRUCTION AND / OR DEMOLITION WASTE MANAGEMENT

- A. All construction and demolition waste suitable for recycling must go to Dane County Construction & Demolition Recycling Facility located at 7102 US Hwy 12, Madison, located across from Yahara Hills Golf Course. This facility can receive mixed loads of construction and demolition waste. For complete list of acceptable materials see www.countyofdane.com/pwht/recycle/CD_Recycle.aspx.
- B. Dane County Landfill, also at 7102 US Hwy 12, Madison, must receive all other waste from this project. www.countyofdane.com/pwht/recycle/landfill.aspx.

1.4 WASTE MANAGEMENT PLAN

- A. Contractor shall develop Waste Management Plan (WMP) for this project. Public Works Project Manager and / or Architect / Engineer may be contacted with questions. Outlined in RECYCLING section of this specification are examples of materials that can be recycled or reused as well as recommendations for waste sorting methods.

B. Contractor shall complete WMP and include cost of recycling / reuse in Bid. WMP will be submitted to Public Works Project Manager within fifteen (15) business days of Bid Due date.. Copy of blank WMP form is in this Section. Submittal shall include cover letter and WMP form with:

1. Information on:
 - a. Types of waste materials produced as result of work performed on site;
 - b. Estimated quantities of waste produced;
 - c. Identification of materials with potential to be recycled or reused;
 - d. How materials will be recycled or reused;
 - e. On-site storage and separation requirements (on site containers);
 - f. Transportation methods; and
 - g. Destinations.

1.5 REUSE

A. Contractors and subcontractors are encouraged to reuse as many waste materials as possible. Salvage should be investigated for materials not reusable on site.

1.6 RECYCLING

A. These materials must be recycled at Dane County Construction & Demolition Recycling Facility:

1. Wood.
2. Wood Pallets.
3. PVC Plastic (pipe, siding, etc.).
4. Asphalt & Concrete.
5. Bricks & Masonry.
6. Vinyl Siding.
7. Cardboard.
8. Metal.
9. Unpainted Gypsum Drywall.
10. Shingles.

B. These materials can be recycled elsewhere in Dane County area:

1. Fluorescent Lamps.
2. Foam Insulation & Packaging (extruded and expanded).
3. Carpet Padding.
4. Barrels & Drums.

C. All materials must be recycled at WDNR permitted waste processing facilities that adhere to all State Statutes.

1.7 MATERIALS SORTING AND STORAGE ON SITE

A. Contractor shall provide separate containers for recyclable materials. Number of containers will be dependent upon project and site conditions.

B. Contractor shall provide on-site locations for subcontractors supplied recycling containers to help facilitate recycling.

- C. Mixed loads of recycled materials are allowed only per instructions at www.countyofdane.com/pwht/recycle/CD_Recycle.aspx.

1.8 LISTS OF RECYCLING FACILITIES PROCESSORS AND HAULERS

- A. Refer to www.countyofdane.com/pwht/recycle/CD_Recycle.aspx for information on Dane County Construction & Demolition Recycling Facility.
- B. Web site www.countyofdane.com/pwht/recycle/categories.aspx lists current information for Dane County Recycling Markets. Contractors can also contact Jan Neitzel-Knox at 608/266-4029, or local city, village, town recycling staff listed at site www.countyofdane.com/pwht/recycle/contacts.aspx. Statewide listings of recycling / reuse markets are available from UW Extension at www4.uwm.edu/shwec/wrmd/search.cfm.

PART 2 PRODUCTS

Not Used.

PART 3 EXECUTION

Not Used.

END OF SECTION

WASTE MANAGEMENT PLAN FORM



Contractor Name: _____

Address: _____

Phone No.: _____ Recycling Coordinator: _____

MATERIAL	ESTIMATED QUANTITY	DISPOSAL METHOD (CHECK ONE)		RECYCLING / REUSE COMPANY OR DISPOSAL SITE
Salvaged & reused building materials	_____ cu. yds. _____ tons	_____ Recycled	_____ Reused	Name: _____
Wood	_____ cu. yds. _____ tons	_____ Recycled	_____ Reused	Name: _____
Wood Pallets	_____ units	_____ Recycled	_____ Reused	Name: _____
PVC Plastic	_____ cu. ft. _____ lbs.	_____ Recycled	_____ Reused	Name: _____
Asphalt & Concrete	_____ cu. ft. _____ lbs.	_____ Recycled	_____ Reused	Name: _____
Bricks & Masonry	_____ cu. ft. _____ lbs.	_____ Recycled	_____ Reused	Name: _____
Vinyl Siding	_____ cu. ft. _____ lbs.	_____ Recycled	_____ Reused	Name: _____
Cardboard	_____ cu. ft. _____ lbs.	_____ Recycled	_____ Reused	Name: _____
Metals	_____ cu. yds. _____ tons	_____ Recycled	_____ Reused	Name: _____
Unpainted Gypsum / Drywall	_____ cu. yds. _____ tons	_____ Recycled	_____ Reused	Name: _____
Shingles	_____ cu. yds. _____ tons	_____ Recycled	_____ Reused	Name: _____
Fluorescent Lamps	_____ cu. ft. _____ lbs.	_____ Recycled	_____ Reused	Name: _____
Foam Insulation	_____ cu. ft. _____ lbs.	_____ Recycled	_____ Reused	Name: _____
Carpet Padding	_____ cu. ft. _____ lbs.	_____ Recycled	_____ Reused	Name: _____
Barrels & Drums	_____ units	_____ Recycled	_____ Reused	Name: _____

WASTE MANAGEMENT PLAN FORM

Glass	_____ cu. yds. _____ tons	_____ Recycled _____ Landfilled	_____ Reused _____ Other	Name: _____
Other	_____	_____ Recycled _____ Landfilled	_____ Reused _____ Other	Name: _____
Other	_____	_____ Recycled _____ Landfilled	_____ Reused _____ Other	Name: _____
Other	_____	_____ Recycled _____ Landfilled	_____ Reused _____ Other	Name: _____
Other	_____	_____ Recycled _____ Landfilled	_____ Reused _____ Other	Name: _____
Other	_____	_____ Recycled _____ Landfilled	_____ Reused _____ Other	Name: _____

SECTION 03 30 00 CAST-IN-PLACE CONCRETE

SCOPE Applicable provisions of the General and Supplementary Conditions and Division 1 govern work under this Section.

INDEX 1.1 Description 1.3 Submittals
1.2 Quality Assurance 2.1 Supplemental Requirements

PART 1 GENERAL

1.1 Description

A. Work Included: Cast-in-place concrete required for this work (including forms and reinforcing) is indicated on the drawings and includes but is not necessarily limited to:

1. Footings - foundations
2. Exterior flat work
3. Interior floor slabs and concrete topping on metal deck
4. Curbs
5. Landings & steps at metal pan stairs

B. Related Work Specified Elsewhere

1. Testing laboratory Per Construction Manager
2. Sitework Per Civil Drawings
3. Miscellaneous Metal Section 05 50 00

C. Work Installed but Furnished by Others: Anchor bolts, templates and built-in items for precast work, Section 03 41 00 and steel work, Section 05 12 00.

1.2 Quality Assurance

- A. Workers: Use only workers experienced in the placing and finishing of concrete and erecting of reinforcing.
- B. Codes and Standards: Concrete work shall conform to all requirements of ACI 301, Specifications for Structural Concrete for Buildings Current Edition, except as modified by the Supplemental Requirements below:
1. A copy of ACI-301, Specifications for Structural Concrete for Buildings is on file at the office of the Architect. The Contractor in submitting a proposal verifies that he has complete knowledge of ACI 301. A copy of ACI 301 will be bound into the copy of the building Specifications and kept on the site during construction. All concrete work will also conform to ACI 318-05 Building Code Requirements for Reinforced Concrete.

1.3 Submittals: At award of Contract and before any concrete is delivered to the job site submit to the Architect in accordance with these Specifications: Reinforcing steel drawings and Mix designs.

PART 2 PRODUCTS

2.1 Supplemental Requirements: Numbers listed below correspond to numbering designations used in ACI 301, Specifications for Structural Concrete for Buildings.

- (1.6) Testing: Take test cylinders as directed by Architects for testing by Owner.
- (2.2.1.4) Joint at perpendicular filler to meet Article 2.2.1.4
- (3.1) Reinforcement: Where fiber mesh reinforcing is called for on the drawings, dosage shall be 5 lb. per cubic yard. Fiber mesh reinforcement is not permitted in concrete to be polished.
- (3.2) Reinforcing steel:
3.2.1.1 Deformed bars grade: ASTM A 615 Grade 60, New billet steel.
3.2.1.5 Wire grade: ASTM A 185.
- (4.2.1.4) Admixtures: No admixtures other than air-entraining agent specified will be permitted, except upon written request by the Contractor and written approval by the Architect.
- (4.2.2) Concrete Strength: All concrete - 4000 psi at 28 days.
- (4.2.2.2) Maximum slumps as follows: Walls and footings - 3"; Slabs and Piers - 4"; Slump tests must be taken for each truck load of concrete.
- (5.3.1) Placing: Notify Architect 24 hours in advance of starting time of each pour. Allow time for inspection of forms, reinforcement, screeds, etc., and to explain procedures for slump and cylinder tests.
- (5.3.1) Concrete contractor to verify actual topping thickness to account for camber in steel joists.
- (5.3.3.3) As-cast finishes:
5.3.3.3.b Smooth form finish required.
- (5.3.3.4.a) Smooth rubbed finish on exposed sections of retaining walls, exposed foundations and curbs. Remove form marks prior to application. Commercial coating as approved by Architect.
- (5.3.4.2) Tolerances: Concrete to be true to plane, plumb and level with true curves. Deviations from dimensions, pitches, contours may not exceed 1/4" when by adding to scratch coat this may be corrected. Deviations which require a reduction in total two inch thickness of tile and setting bed, as shown on the Drawings will not be allowed.
- (5.3.4.2.d) Stiff broom finish on stair treads and areas to receive ceramic tile.
- (5.3.5) Control Joints: saw cut or trowel as shown on plan or max size 14'-0" x 14'-0" curbing 10' o.c.
- (5.3.6) Concrete Surface Sealer: Where noted as "Ashford" on Room Finish Schedule and Painting Schedule, Ashford Formula by Cure Crete. Apply per manufacturer's specifications for new concrete immediately after finishing.

(5.3.6) Concrete Surface Sealer: At all slabs to remain exposed and not noted as "Ashford" on Room Finish Schedule and Painting Schedule, Sonneborn Lapidolith. Apply per manufacturer's specifications for new concrete immediately after finishing.

* * * * *

THIS PAGE INTENTIONALLY LEFT BLANK

SECTION 04 20 00 UNIT MASONRY

SCOPE Applicable provisions of the General and Supplementary Conditions and Division 1 govern work under this Section.

INDEX	1.1 Description	2.1 Materials
	1.2 Quality Assurance	3.1 Surface Conditions
	1.3 Product Delivery, Storage and Handling	3.2 Co-ordination
	1.4 Job Conditions	3.3 Installation
		3.4 Field Quality Control
		3.5 Cleaning Up

PART 1 GENERAL

1.1 Description

- A. Work Included: Unit Masonry required for the work is indicated on the Drawings and includes, but is not limited to:
1. Load bearing and nonload bearing interior concrete block.
 2. Furnish and install wall reinforcement and anchorages.
 3. Install items furnished by other Sections of the Work.
 4. Furnish and install masonry accessories.
 5. Install reinforcement in bond beams and fill with concrete.
 6. Install reinforcement in bond beam lintels under 3'-8" and fill with mortar.
 7. Fill cells of block at pilasters and for grouted wall construction.
 8. Grout under base and bearing plates on masonry walls.
 9. Slush full all jambs of hollow metal frames.
- B. Related Work Specified Elsewhere
- | | |
|-----------------------------|------------------|
| 1. Cleaning | Section 01 77 00 |
| 2. Concrete | Section 03 30 00 |
| 3. Rough carpentry | Section 06 10 00 |
| 4. Flashing and sheet metal | Section 07 60 00 |
| 5. Caulking | Section 07 92 13 |
| 6. Finish Painting | Section 09 91 00 |
- C. Work Installed but Supplied by Others
- | | |
|---------------------|------------------|
| 1. Loose lintels | Section 05 10 00 |
| 2. Bolts | |
| 3. Anchors | |
| 4. Inserts | |
| 5. Expansion Joints | |
- D. Work by Owner: Hiring of testing agency for on-site testing.

1.2 Quality Assurance

- A. Qualifications of Workmen
1. For the actual cutting and placing of concrete masonry units, use only skilled journeyman masons who are thoroughly familiar with the design requirements.

2. In acceptance or rejection of installed concrete masonry units, no allowance will be made for lack of skill on the part of workmen.
 3. Provide one skilled journeyman mason who shall be present at all times during execution of the work of this Section and who shall personally direct the execution of this portion of the Work.
- B. Tolerances: Walls to be erected in accord with standard industry practices and written guidelines of ACI Standard for concrete masonry and BIA Standards for brick masonry.
- C. Requirements of Regulatory Agencies: Work of this Section shall comply with all applicable building codes and as supplemented in subsequent articles contained herein.
- D. Reference Standards: In addition to complying with all pertinent codes and standards, comply with the following standards of masonry installation described in:
1. Masonry construction and materials shall conform to all requirements of (ACI-530).
 2. "Specifications for the Design and Construction of Load Bearing Concrete Masonry", by the National Concrete Masonry Association (NCMA).
 3. Recommended practices of the International Masonry Industry All-Weather Council.
 4. Modular System: Sizes of masonry units and brick: Modular sizes, whether so indicated or not, so that materials specified in this Section will be as per Modular Planning Standards.
 5. American Society of Testing and Materials (ASTM):
 - a. A 82, Cold Drawn Steel Wire for Concrete Reinforcement.
 - b. A 153, Zinc Coating (Hot-Dip) on Iron and Steel Hardware.
 - c. A 615, Deformed Billet-Steel Bars for Concrete Reinforcement
 - d. C 90, Load Bearing Concrete Masonry Units.
 - e. C 129, Hollow non-load Bearing Concrete Masonry Units.
 - f. C 270, Mortar for Unit Masonry.
 - g. C 387, Packaged Dry, Combined Materials for Mortar and Concrete.
 6. Federal Specifications (FS):
 - a. QQ-W-461, Carbon Steel Wire.

1.3 Product Delivery, Storage and Handling

- A. Protection:
1. Use all means necessary to protect the materials of this Section before, during and after installation and to protect the installed work and materials of all other trades.
 2. Stack masonry for facing work on platforms; cover or store in an approved manner that will protect them from contact with soil, weather exposure. Exercise care in handling masonry units to avoid chipping, breakage. Locate storage piles, stacks or bins to avoid being disturbed, or barricade to protect materials from damage. Stack units immediately upon delivery to job, under cover, or otherwise protect from weather conditions.
 3. Protect anchors, ties and reinforcement from elements.
 4. Mortar Materials
 - a. Deliver and store manufactured products in original unopened containers.
 - b. Keep water free of harmful materials.
- B. Replacements: In the event of damage, immediately make all repairs and replacements necessary to the approval of the Architect and at no additional cost to the Owner.

1.4 Job Conditions

A. Environmental Requirements

1. Cold Weather Protection

a. Preparation:

- (1) Remove ice or snow formed on masonry bed by carefully applying heat until top surface is dry to touch.
- (2) Remove frozen or damaged masonry.
- (3) Use dry masonry units.
- (4) Do not use frozen units.

b. Mortar

- (1) Heat mixing water when air temperature is below 40 degrees F. and heat aggregates when air temperature is below 32 degrees F., to assure mortar temperatures between 40 degrees F. and 120 degrees F. until used.
- (2) Do not heat water or sand above 120 degrees F.

c. Protection Requirements While Masonry Units are Being Laid:

- (1) Air temperature 25 degrees F. to 20 degrees F.:
 - (a) Use salamanders or other heat sources on both sides of walls under construction.
- (2) Air temperature 20 degrees F. and below.
 - (a) Provide enclosures and auxiliary heat to maintain air temperature above 32 degrees F.
 - (b) Minimum temperature of units when laid: 20 degrees F.

d. Protection Requirements for Completed Masonry and Masonry not being worked on:

- (1) Mean daily air temperature 48 degrees F. to 32 degrees F.: Protect masonry from rain or snow for 24 hours by covering with non-staining weather-resistive membrane.
- (2) Mean daily air temperature 32 degrees F. to 25 F degrees: Completely cover masonry with nonstaining weather-resistive membrane for 24 hours.
- (3) Mean daily air temperature 25 degrees F. to 20 degrees F.: Completely cover masonry with insulating blankets or equal protection for 24 hours.
- (4) Mean daily air temperature 20 degrees F. and below: Maintain masonry temperature above 32 degrees F. for 24 hours by enclosure and supplementary heat, electric heating blankets, infra-red lamps, or other acceptable methods.
- (5) Cover top of walls with nonstaining waterproof coverings at end of each day or shutdown.
- (6) Cover partially completed walls with nonstaining waterproof membrane when work is not in progress.
- (7) Provide minimum 2 foot overhand of protective covering on each side of wall securely anchored.
- (8) Do not apply uniform floor or roof loading for at least 12 hours after completing masonry columns or walls.
- (9) Do not apply concentrated loads for at least three days after completing masonry columns or walls.

2. Hot Weather Protection: Protect masonry construction from direct exposure to wind and sun when erected in an ambient air temperature of 99 degrees F. in the shade with relative humidity less than 50 percent.

PART 2 PRODUCTS

2.1 Materials

A. Mortar

1. ASTM C 387, color as selected by Architect.
2. Color as selected.
3. Mixes:
 - a. Mix mortar materials to product mortar cubes having the following compressive strength when tested in accord with compressive strength test, ASTM C 270.

MORTAR TYPE	COMPRESSIVE STRENGTH (PSI)	WATER RETENTION	MAXIMUM AIR CONTENT
M	2500	75	18
S	1800	75	18

B. Concrete Masonry Units

1. Load Bearing Units:
 - a. ASTM C 90, Type II Grade N
 - b. Nominal face dimensions: 8 inches by 16 inches.
2. Hollow Nonload Bearing Units:
 - a. ASTM C 129, Type II
 - b. Nominal face dimensions: 8 inches by 16 inches.
3. Provide light weight aggregate units.
4. Bond: running
5. Approve Manufacturers: Prairiestone, Harvard Brik, Trendstone Plus

C. Setting material for base and bearing plates: Mortar shall be same as used in all construction.

D. Anchors and Ties:

1. Welded Wire:
 - a. Type: truss
 - b. Longitudinal wire:
 - (1) Style: single
 - (2) Treatment: deformed
 - (3) Wire: ASTM A 82
 - (4) Size: 9 gauge
 - c. Transverse wires:
 - (1) Wire ASTM A 82
 - (2) Size: 9 gauge
 - d. Finish: Galvanized, FS QQ-W-461, Finish No. 5, Class No.3.
 - e. Installation to conform to Chapter 21 of the International Building Code
2. Corrugated Metal:
 - a. Type: plain end.
 - b. Material: galvanized steel
 - c. Size:
 - (1) Thickness: 22 Gauge.
 - (2) Length: System required to pass thru 3" insulation and 3" into stone.
 - (3) Width: 3/4 inch
 - d. Finish: Galvanized, ASTM A 153, Class B-2.

F. Reinforcement: Billet Steel Deformed Bars: ASTM A 615, Grade 60

- G. Weephole Material: Plastic or rubber tube. 24" o.c. at masonry terminations at concrete or steel.
- H. Flashing: Butyl rubber membrane locate where detailed on Drawings or standard masonry practice to relieve water penetration brick veneer.
- I. Cleaning Agents: As recommended by block supplier.
- J. Grout: All grout shall be transit-mixed in accord with ASTM C 94 and shall consist of one part portland cement, 2-1/2 parts sand, two parts pea gravel, and adequate water to produce a concrete of approximately ten inches slump, and shall have an ultimate compressive strength of at least 2000 psi in 28 days.
- K. Control Joint Resilient Keys: Control joint resilient keys: Factory-fabricated solid section of natural or synthetic rubber, combination thereof, plastic, or other rubber-like material. Durometer hardness shall be not less than 70 when tested in conformance with ASTM Specification D 2240. The key shall be of the shape indicated and of dimensions to completely fill and fit neatly, but without forcing, into masonry-unit jamb-sash grooves and to provide control-joint width of 3/8 inch with tolerance of 1/6 inch. Shear section shall be 5/8 inch minimum thickness.

PART 3 EXECUTION

3.1 Surface Conditions

- A. Inspection
 - 1. Prior to all Work of this Section the mason contractor shall inspect related installed work of other trades, notify the Project Manager who shall verify that such work is complete to the point where portions of the masonry installation may properly commence.
 - 2. Verify that unit masonry may be completed in accord with the referenced standards and the contract documents.
- B. Discrepancies
 - 1. In the event of discrepancy, immediately notify the Project Manager and the Architect for clarification.
 - 2. Do not proceed with installation in areas of discrepancy until all such discrepancies have been completely resolved.

3.2 Co-ordination: Carefully coordinate with all other trades to insure proper and adequate interface of the work of other trades with the work of this Section.

3.3 Installation

- A. General
 - 1. Protection: Protect masonry surfaces not being worked during construction work. At such time as rain or snow is imminent, work is discontinued; protect work with water proof membrane, well secured. Overlap covering two feet each side of wall.
 - 2. Temperature: Do not erect masonry when ambient temperature has dropped below 45 degrees F., unless it is rising; at no time when it has dropped below 40 degrees F., except by written permission.

When masonry work is authorized during temperatures below 40 degrees F., make provisions for heating and drying materials. Protect completed work as per recommended practices for cold weather masonry construction by the International Masonry Industry All-weather Council.

3. At completion of each day's work, all masonry should be cleaned with brushes and as required to keep work neat and clean at all times; covered and protected from weather.
4. Do not permit mortar to touch aluminum surfaces to be exposed.
5. Do not use chopped or broken units; if any such units are discovered in the finished wall, the Architect will require their immediate removal and replacement with new units at no additional cost to the Owner.
6. Lay masonry plumb, true to line, with level, accurately spaced courses. Keep bond plumb throughout. Lay corners, reveals, plumb, true. Exposed block to be running bond. Set in ties, "Durowall" or "AA Wire" reinforcing, etc.
7. Building-In: Unless otherwise required, fill solidly with mortar, spaces around metal door frames, and other built-in items. Built-in work required to be built-in with masonry, including anchors, wall plugs, accessories, as erection progresses.
8. Cutting, patching: For cutting, patching of masonry required to accommodate work of others use masonry mechanics. Use masonry saws to cut and fit masonry units.
9. Adjust masonry unit to final position while mortar is soft and plastic.
10. If units are displaced after mortar has stiffened, remove, clean joints and units of mortar and relay with fresh mortar.
11. Adjust shelf angles to keep masonry level and at proper elevation.
12. Provide pressure-relieving joints by placing a continuous 1/8 inch foam neoprene pad under the shelf angle and seal joint with sealant specified in Division 7.
13. When joining fresh masonry to set or partially set masonry construction, clean exposed surface of set masonry and remove loose mortar prior to laying fresh masonry.
14. If necessary to stop off a horizontal run of masonry, rack back one-half block length in each course.
15. Do not use toothing to join new masonry to set or partially set masonry when continuing a horizontal run.
16. Anchors, ties and reinforcement: Remove all dirt, ice, loose rust and scale prior to installation.
17. Placement of loads (i.e. floors and upper walls) on completed sections of masonry construction shall not proceed until 7 days have elapsed from the completion of that particular construction. Placement of such loads may be made in advance of this time period provided that prism tests show that the construction has achieved sufficient strength and also subject to the approval of the Architect.
18. Installing Control Joints
 - a. Provide expansion and control joints as shown on Drawings. Sealants and backing will be by Sealant Contractor.
 - b. Control joints shall extend through bond beams unless otherwise indicated.
19. Setting Base and Bearing Plates: For those base and bearing plates set by masons, place grout under plates to thoroughly fill all the space under the plates. Plates to be set level.

B. Mixing Mortar

1. General
 - a. Use a mechanical mixer of one sack minimum capacity.
 - b. Mix mortar at least three minutes after all materials have been added.

- c. Mix only as much mortar as can be used in one hour after water has been first mixed into batch.
2. Retempering: Retemper mortar only within 2-1/2 hours of mixing. Discard unused mortar that has begun to set or that is more than 2-1/2 hours old.

C. Built-in Items

1. Build in, around, items required, as indicated. Set loose lintels, small beam plates, bearing strips, in locations required, as indicated. Loose lintels, small beam plates, bearing strips furnished under "Structural Steel" Section. Set anchors, anchor bolts for parapet, fascia, cap, door frames, flashing, etc.
2. Avoid cutting and patching.
3. Solidly grout spaces around built-in items.

D. Blockwork

1. General
 - a. Lay only dry units. Wetting the units shall not be permitted except when hot and dry weather exists causing the units to be warm to the touch, and then the surface only may be wetted with a light fog spray.
 - b. Bond: Running bond with vertical joints located at center of masonry units in alternate course below.
2. Reinforcement
 - a. Install all reinforcement as indicated on the Drawings.
 - b. Fully embed reinforcement in grout, not in mortar or mortar joints.
 - c. Furnish and install all required metal accessories to insure accurate alignment of steel during grout filling operations.
3. Mortar Beds
 - a. Hollow Units:
 - (1) Lay with full mortar coverage on horizontal and vertical face shells.
 - (2) Provide full mortar coverage on horizontal and vertical face shells and webs in all courses of following:
 - (a) Piers, columns and pilasters.
 - (b) Starting course on footings and solid foundation walls.
 - (c) Where adjacent to cells or cavities to be filled with grout.
 - b. Solid Units: Lay with full mortar coverage on horizontal and vertical joints.
4. Joints:
 - a. Horizontal and vertical face joints.
 - (1) Nominal thickness: 3/8 inch.
 - (2) Construct uniform joints.
 - (3) Shove vertical joints tight.
 - (4) Strike joints flush in surfaces to be plastered, stuccoed, or covered with other masonry, or other surface-applied finish other than paint.
 - (5) Point joints tight in unparged masonry below ground.
 - (6) Tool joints in exposed or to-be-painted surfaces when thumb-print hard with round jointer.
 - (7) Remove mortar protruding into cells of cavities to be reinforced or filled.
 - (8) Fill horizontal joints with mortar between top of masonry partitions and underside of concrete slabs or beams
5. Grouting
 - a. Timing: Do not grout until masonry has cured at least 24 hours.

- b. Consolidation: Consolidate all grout at time of pouring by puddling with a mechanical vibrator, filling all cells of the masonry, and then reconsolidating later by puddling before the plasticity is lost.
- 6. Pointing and Cleaning
 - a. At final completion of unit masonry work fill holes in joints and tool.
 - b. Do not fill weepholes.
 - c. Cut out and repoint defective joints.
 - d. Dry brush masonry surface after mortar has set, at end of each day's work and after final pointing.
 - e. Leave work and surrounding surfaces clean and free of mortar spots and drippings.

3.4 Field Quality Control

- A. Prism Testing
 - 1. These requirements generally meet NCMA or BIA. The required 28 day strength, f'm, is shown on the Drawings for each class of masonry construction. The actual strength of the masonry construction shall be determined by the prism method.
 - 2. One prism test consisting of three specimens for each class of masonry shall be made in advance of construction to confirm f'm. Prisms made at the job site shall be carefully handled so as to preclude damage during both handling operations and transportation to testing lab per ASTM E 447.
 - a. Of the three specimens used in the advance test, two shall be tested at 28 days and one shall be tested at 7 days.
 - b. As part of the advance test procedure, six 2 inch by 2 inch by 2 inch mortar cubes shall be fabricated and tested with the three prism specimens. Two tests shall be at 7 days and four at 28 days.
 - c. As a part of the advance test procedure, tests on three masonry units shall be made at the same time as the 28 day prism test.
 - 3. After prism testing and during the construction process, additional prism tests will be required. Prism tests are as defined above and one test shall be made for each 5000 square feet of wall constructed. Subject to written approval of the Architect, test of units and mortar cubes may be made in lieu of prism test. Cubes shall be as described above. Three unit tests will be required at the testing of each set of mortar cubes. For bidding purposes, assume that prism tests will be required during the construction phase.
- B. Mortar Tests: The Architect may at his sole discretion order test on mortar at any time during the construction to insure compliance with the Property requirements of Part 2 even though laboratory test data has been submitted. Mason Contractor shall cooperate with the testing laboratory during the taking of samples.

3.5 Cleaning Up

- A. Inspection and Adjustment: Upon completion of the Work of this Section, make a thorough inspection of all installed masonry and verify that all units have been installed in accord with the provisions of this Section. Make all necessary adjustments.
- B. Cleaning
 - 1. Clean, point and wash down brick and concrete block surfaces. Clean as units are being set and again upon completion. Use all cleaning agents in strict conformance with the Manufacturer's instructions. Make ready for application of the specified finishes.

2. Remove surplus mortar and leave surface of all masonry clean and finished.
Remove large particles of mortar with putty knife or chisel before cleaning walls.
Remove sharp burrs on exposed block mortar joints with rubbing stone.
3. Remove shoring, supports, centering, scaffolding, mason's wedges, false work and protection. Remove mortar spattering from sills, walls and finished work of other trades and contractors. Take special care during cleaning operations not to damage glass, window frames, shrubbery or other similar completed adjacent construction.

* * * * *

THIS PAGE LEFT INTENTIONALLY BLANK

SECTION 05 50 00 METAL FABRICATIONS

SCOPE Applicable provisions of the General and Supplementary Conditions and Division 1 govern work under this Section.

INDEX	1.1 Description	2.2 Fabrication
	1.2 Quality Assurance	3.1 Surface Conditions
	1.3 Submittals	3.2 Preparation
	1.4 Product Delivery, Storage and Handling	3.3 Erection
	2.1 Materials	3.4 Cleaning

PART 1 GENERAL

1.1 Description

- A. Work Included: Metal fabrications required for this work are indicated on the Drawings and include, but are not necessarily limited to:
 - 1. Handrails and railings
 - 2. Miscellaneous metal fabrications
 - 3. Metal Stairways

- B. Related Work Specified Elsewhere
 - 1. Concrete Section 03 30 00
 - 2. Masonry Section 04 20 00
 - 3. Rough Carpentry Section 06 10 00
 - 4. Finish Painting Section 09 91 00

- C. Work Furnished but Not Installed
 - 1. Metal fabrications cast in concrete Section 03 30 00
 - 2. Metal fabrications embedded in masonry Section 04 20 00

1.2 Quality Assurance

- A. Qualifications
 - 1. Fabricator: Fabricator shall have not less than 5 years experience in the fabrication of metal fabrications.
 - 2. Welding: All welding shall be performed by operators who have been recently qualified as prescribed in "Qualification Procedure" of the American Welding Society.

- B. Requirements of Regulatory Agencies: In addition to complying with all pertinent codes and regulations, comply with:
 - 1. "Code for Welding in Building Construction" of the American Welding Society.
 - 2. Specifications for Structural Joints Using ASTM A 325 or A 490 Bolts, approved by the Research Council on Riveted and Bolted Joints of the Engineering Foundation.
 - 3. Specifications of the Structural Steel Painting Council.
 - 4. Applicable Building Code. All railings to meet requirements.
 - 5. In the event of conflict between pertinent codes and regulations and the requirements of the referenced standards or these Specifications, the provisions of the more stringent shall govern.

- C. Source Quality Control: Inspection of shop welds shall be in accord with Section 6 of AWS Building Code.
- D. Reference Standards
 - 1. American Society for Testing and Materials (ASTM):
 - a. A 36, Structural Steel
 - b. A 123, Zinc (Hot-Dip Galvanized) Coatings on Iron and Steel Products
 - c. A 325, High Strength Bolts for Structural Steel Joints
Including Suitable Nuts and Plain Hardened Washers.
 - d. A 501, Hot-Formed Welded and Seamless Carbon Steel Structural Tubing.
 - e. F 1554, Anchor Bolts, Steel, 36, 55, and 105-ksi Yield Strength
 - 2. American Welding Society (AWS)
 - a. D 1.1, Structural Welding Code.
 - 3. Federal Specifications (FS):
 - a. TT-P-645, Primer, Paint Zinc Chromate, Alkyd Type.
 - 4. Structural Steel Painting Council (SSPC)
 - a. Paint 13, Number 13 Red or Brown One-Coat Shop Paint.

1.3 Submittals: Within 35 days after award of Contract, and before any of the materials of this Section are delivered to the job site, submit complete to the Architect in accordance with these Specifications; the following:

- A. Shop Drawings: Show all shop and erection details including cuts, copes, connections, holes, threaded fasteners, rivets, and welds. All welds, both shop and field, shall be indicated by AWS "Welding Symbols" A 2.0. Indicate all required field measurements.
- B. Maintenance Instruction: Procure from manufactures of exposed metals, recommendations describing procedures for maintaining, including cleaning materials, application methods and precautions as to use of materials which may be detrimental to finish when improperly applied.

1.4 Product Delivery, Storage and Handling

- A. Protection: Use all means necessary to protect metal fabrications before, during and after installation and to protect the installed work and materials of all other trades.
- B. Delivery of Materials to be Installed Under Other Sections:
 - 1. Anchor bolts and other anchorage devices which are embedded in cast-in-place concrete or masonry construction shall be delivered to the project side in time to be installed before the start of cast-in-place concrete operations or masonry work.
 - 2. Provide setting drawings, templates, and directions for the installation of the anchor bolts and other devices.
- C. Storage of Materials
 - 1. Metal fabrications which are stored at the project site shall be above ground on platforms, skids or other supports.
 - 2. Steel shall be protected from corrosion.
 - 3. Other materials shall be stored in a weather tight and dry place, until ready for use in the work.
 - 4. Packaged materials shall be stored in their original unbroken package or container.

- D. Replacements: In the event of damage, immediately make all repairs and replacements necessary to the approval of the Architect and at no additional cost to the Owner.

PART 2 PRODUCTS

2.1 Materials

- A. Steel: ASTM A 36.
- B. Bolts, Nuts and Washers: High strength type recommended for structural steel joints; ASTM A 325.
- C. Welding Materials: Applicable AWS D1.1, type required for materials being welded.
- D. Anchor Bolts: conform to ASTM F-1554 - 36.
- E. Steel Bar
 - 1. Carbon Steel
 - a. Shape: round, square or rectangular
 - b. ASTM A 501
 - 2. Fittings
 - a. Carbon Steel: ASTM A 36, 1010 low carbon plate.
 - b. Lead: FS QQ-C-40, type I grade AA, form ingots.
 - c. Machine screws: FS FF-S-92, type III style 2c.
 - d. Cement: Hydraulic, quick-setting, ASTM C 595, factory prepared with accelerator.
- F. Railings: Tube stock per details.
- G. Metal pan stairs and landings: tube or bar railings; stair as detailed. Pipe rail as detailed.
- H. Shop Paint Primer: Standard primer: SSPC Paint 13.
- I. Galvanized Coating: For materials called out as 'galvanized', provide G-90 hot-dipped coating per ASTM A-123.
- J. Other Materials: All other materials, not specifically described but required for a complete and proper installation of metal fabrications, shall be new, free from rust, first quality of their respective kinds, and subject to the approval of the Architect. Fabricate and supply to concrete or masonry subcontractor all cast-in weld plates to anchor railings. See Drawings for toe guards.

2.2 Fabrication

- A. Fabricate metal fabrications in accord with the Shop Drawings and reference standards with the modifications and additional requirements specified in this Section. Fabricate items with joints nearly fitted and properly secured. Fit and shop assemble in largest practical sections, for delivery to site.
- B. Connections:
 - 1. Shop Connections: Welded or bolted.

2. Field Connections:
 - a. Provide bolted connections as follows:
 - (1) High strength threaded fasteners shall be used for bolted connections, except where standard threaded fasteners are permitted.
 - (2) High strength bolted construction assembly: tightening shall be done in accord with Section 5 of Specifications for Structural Joints.
 - (3) Fabricator is responsible for design and strength of connections unless otherwise noted on the Drawings.
 3. Exposed Mechanical Fastenings: Flush countersunk screws or bolts unobtrusively located consistent with design of structure, except where specifically noted otherwise.
 4. Make exposed joints flush butt type hair line joints where mechanically fastened.
 5. Supply components required for proper anchorage of metal fabrications. Fabricate anchorage and related components of same material and finish as metal fabrication, unless otherwise specified.
- C. Holes:
 1. Punch holes as required for connection of other work per templates and directions of such trades.
 2. Steel requiring accurate alignment shall be provided with slotted holes and shims for trueing up steel, as required for alignment.
- D. Welded Construction:
 1. Welding process shall be limited to one or a combination of the following:
 - a. Manual shielded-arc
 - b. Submerged arc
 - c. Gas metal-arc
 - d. Flux cored arc
 - e. Electroslag
 - f. Electro gas
 2. Welded assemblies shall be stress relieved by heat treatment.
 3. Use equipment which will supply proper current in order that operator may produce satisfactory welds. Welding machine: 200 to 400 amperes, 25-40 volts capacity.
 4. Field welding: by direct current. Remove paint within two inches of weld.
 5. Grind exposed welds smooth and flush with adjacent finished surface.
- E. Pipe and Tube Railings
 1. Cut pipe square within 2 degrees and to lengths within 1/8 inch.
 2. Remove butts from cut edges.
 3. Form and assemble joints which will be exposed to the weather so as to exclude water.
- F. Shop Painting: Shop paint all steel work unless noted as 'galvanized'.

PART 3 EXECUTION

3.1 Surface Conditions

- A. Inspection
 1. Prior to installation of the Work of this Section, carefully inspect the installed work of all other trades and verify that all such work is complete to the point where this installation may properly commence.

2. Verify that metal fabrications may be fabricated and erected in strict accord with the original design, the approved Shop Drawings and the reference standards.

B. Discrepancies

1. In the event of discrepancy, immediately notify the Architect.
2. Do not proceed with fabrication or installation in areas of discrepancy until all such discrepancies have been fully resolved.

3.2 Preparation

- A. Field Measurements: Take field measurements to verify or supplement dimensions. Be responsible for accurate fit of all work.

3.3 Erection

A. Field Assembly

1. Metal fabrications shall be accurately assembled to the lines and elevations indicated, within the specified erection tolerances.
2. The various members forming parts of a complete frame or structure after being assembled shall be aligned and adjusted accurately before being fastened.
3. Bearing surfaces and surfaces which will be in permanent contact shall be cleaned before the members are assembled.
4. Provide temporary bracing as necessary, and leave in place as long as may be required.
5. Obtain Architect's review prior to site cutting or making adjustments, which are not part of scheduled work.
6. After installation, touch-up field welds and scratches and damaged. Use a primer consistent with shop coat.

3.4 Cleaning

A. Metals to receive paint

1. Wash thoroughly using clean water and soap; rinse with clean water.
2. Do not use acid solution, steel wool or other harsh abrasive.
3. If stain remains after washing, remove finish and restore in accord with recommendations of fabricator.

* * * * *

THIS PAGE LEFT INTENTIONALLY BLANK

SECTION 06 10 00 ROUGH CARPENTRY

SCOPE Applicable provisions of the General and Supplementary Conditions and Division 1 govern work under this Section.

INDEX	1.1 Description	3.2 Workmanship
	1.2 Quality Assurance	3.3 Installation
	1.3 Submittals	3.4 Fastening
	1.4 Product Handling	3.5 Nailing Schedule
	2.1 Grade Stamps	3.6 Protection
	2.2 Materials	3.7 Cleaning Up
	3.1 Surface Conditions	

PART 1 GENERAL

1.1 Description

- A. Work Included: All wood, nails, bolts, screws, framing anchors and other rough hardware, and all other items needed for rough carpentry in this Work but not specifically described in other Sections of these Specifications; and the installation of all blocking as indicated on Drawings.
- B. Related Work Specified Elsewhere
 - 1. Concrete Section 03 30 00
 - 2. Finished Painting Section 09 91 00

1.2 Quality Assurance

- A. Qualifications of Workmen
 - 1. Provide sufficient skilled workmen and supervisors who shall be present at all times during execution of this portion of the Work and who shall be thoroughly familiar with the type of construction involved and the materials and techniques specified.
 - 2. Rejection: In the acceptance or rejection of rough carpentry, no allowance will be made for lack of skill on the part of workmen.
- B. Codes and Standards
 - 1. Lumber grading rules and wood species to be in conformance with Voluntary Product Standard PS 20: Grading rules of the following associations apply to materials furnished under this Section:
 - a. West Coast Lumber Inspection Bureau (WCLIB).
 - b. Western Wood Products Association (WWPA).
 - 2. Requirements of Regulatory Agencies
 - a. Pressure treated material: American Wood Preservers Bureau Standards.
 - b. American Wood Preservers Bureau (AWPB):
 - (1) LB-2, Standard for Softwood Lumber, Timber, and Plywood Pressure Treated with Water-borne Preservatives for Above Ground Use.
 - c. Federal Specifications (FS):
 - (1) FF-B-561, Bolts (Screw), Lag.
 - (2) FF-B-575, Bolts, Hexagon and Square.

- (3) FF-B-584, Bolts, Finned Neck; Key Head; Machine; Ribbed Neck; Square Neck; Tee Head.
- (4) FF-N-105, Nails, Wire, Brads and Staples.
- (5) FF-N-836, Nuts, Square, Hexagon, Cap, Slotted, Castellated, Clinch Knurled and Welding.
- (6) FF-S-111, Screw, Wood.
- d. Product Standards (PS)
 - (1) 20, American Softwood Lumber Standard.
- 3. Conflicting requirements: In the event of conflict between pertinent codes and regulations and the requirements of the referenced standards or these Specifications, the provisions of the more stringent shall govern.

1.3 Submittals

- A. Certification (only on request of Architect)
 - 1. Pressure-treated wood: Submit certification by treating plant stating chemicals and process used, net amount of salts retained, and conformance with applicable standards.

1.4 Product Delivery, Storage and Handling

- A. Protection
 - 1. Use all means necessary to protect the materials before and after delivery to the job site, and to protect the installed work and materials of all other trades.
 - 2. Deliver the materials to the job site and store, all in a safe area, out of the way of traffic.
 - 3. Store materials a minimum of 6 inches above ground on framework or blocking and cover with protective waterproof covering providing for adequate air circulation or ventilation.
 - 4. Do not store seasoned materials in wet or damp portions of building.
 - 5. Protect sheet materials from corners breaking and damaging surface, while unloading.
 - 6. Identify all framing lumber as to grades and store all grades separately from other trades. Keep grade marks legible.
 - 7. Protect all metal products with adequate weatherproof outer wrappings.
 - 8. Keep all damaged material clearly identified as damaged, and separately store to prevent its inadvertent use.
 - 9. Do not allow installation of damaged or otherwise noncomplying material.
 - 10. Use all means necessary to protect the installed work and materials of all other trades.
- B. Replacements: In the event of damage, immediately make all repairs and replacements necessary to the approval of the Architect and at no additional cost to the Owner.

PART 2 PRODUCTS

- 2.1 Grade Stamps:** Identify all other materials of this Section by the appropriate stamp of the agency listed in the reference standards, or by such other means as are approved in advance by the Architect.

2.2 Materials

A. Lumber

1. Dimensions
 - a. Specified lumber dimensions are nominal.
 - b. Actual dimensions to conform to PS 20.
2. Moisture Content: Unseasoned or 19% maximum at time of permanent closing in of building or structure, for lumber 2 inches or less nominal thickness.
3. Surfacing: Surface four sides (S4S), unless specified otherwise.
4. End Jointed Lumber
 - a. Structural purposed interchangeable with solid sawn lumber.
5. Framing lumber, any commercial softwood species
 - a. Light framing
 - (1) General framing: Standard and Better or Stud grade. Chloride treated at roof blocking and where in contact with concrete.
 - (2) Plates, blocking, bracing and nailers: Utility grade.
 - (3) Bracing, blocking, bulk headings and general utility purposes: Economy grade.
 - b. Beams and Headers – Size and Grade as noted on drawings.

B. Building Paper

1. Tyvek commercial wrap membrane or approved equal.
2. WR grace water and ice shield.

C. Preservative-Treated Wood Products

1. Waterborne salt preservatives for painted, stained, or exposed natural wood product:
 - a. AWPB LP-2, above ground applications.
 - b. Lumber redried to maximum moisture content of 19%, stamped "DRY".

D. Rough Hardware

1. Bolts
 - a. FS FF-B-575.
 - b. FS FF-B-584.
2. Nuts: FS FF-N-836.
3. Expansion shields: FS FF-B-561.
4. Lag screws and bolts: FS FF-B-561.
5. Toggle bolts: FS FF-B-588.
6. Wood Screws: FS FF-S-111.
7. Nails and staples: FS FF-N-105.
8. Metal nailing discs:
 - a. Flat caps, minimum 1 inch diameter.
 - b. Minimum 30 gauge sheet metal.
 - c. Formed to prevent dishing.
 - d. Bell or cup shapes not acceptable.

- E. Valance brackets: per details - verify all dimensions with electrical contractor.

PART 3 EXECUTION

3.1 Surface Conditions

A. Inspection

1. Prior to all Work of this Section, carefully inspect the installed work of all other trades and verify that all such work is complete to the point where this installation may properly commence.
 2. Verify that all rough carpentry may be performed in strict accord with the original design and all pertinent codes and regulations.
- B. Discrepancies
1. In the event of discrepancy, immediately notify the Architect.
 2. Do not proceed with installation in areas of discrepancy until all such discrepancies have been fully resolved.

3.2 Workmanship

- A. General: All rough carpentry shall produce joints true, tight and well secured with all members assembled in accord with the Drawings and with all pertinent codes and regulations.
- B. Selection of lumber pieces.
1. Carefully select all members; select individual pieces so that knots and obvious defects will not interfere with placing bolts or proper nailing or making proper connections.
 2. Cut out and discard all defects which will render a piece unable to serve its intended function; lumber may be rejected by the Architect, whether or not it has been installed, for excessive warp, twist, bow crook, mildew, fungus, or mold, as well as for improper cutting and fitting.

3.3 Installation

- A. General Framing
1. General: In addition to all framing operations normal to fabrication and erection indicated on the Drawings, install all backing required for the Work of other trades.

3.4 Fastening

- A. Nailing
1. Use only common wire nails or spikes, except where otherwise specifically noted in the Drawings.
 2. Provide penetration into the piece receiving the point of not less than 1/2 the length of the nail or spike provided, however, that 16d nails may be used to connect two pieces of two inch (nominal) thickness.
 3. Do all nailing without splitting wood, preboring as required; replace all split members.
- B. Bolting
1. Drill holes 1/16 inch larger in diameter than the bolts being used; drill straight and true from one side only.
 2. Bolt threads must not bear on wood; use washers under head and nut where both bear on wood; use washers under all nuts.

C. Screws

1. For lag-screws and wood screws, prebore holes same diameter as root of thread; enlarge holes to shank diameter for length of shank.
2. Screw, do not drive, all lag screws and wood screws.

3.5 Nailing Schedule: Unless otherwise indicated on the Drawings or required by pertinent codes and regulations, provide at least the nailing shown in Table 2304.9.1 Fastening Schedule of the International Building Code – 2000 Edition.

3.6 Protection: Protect wood decking with protective waterproof covering until roofing has been installed.

3.7 Cleaning Up

A. General: Keep the premises in a neat, safe and orderly condition at all times during execution of this portion of Work, free from accumulation of sawdust, cut-ends, and debris.

B. Sweeping

1. At the end of each working day, or more often if necessary thoroughly sweep all surfaces where refuse from this portion of the Work has settled.
2. Remove the refuse to the area of the job site set aside for its storage.
3. Upon completion of this portion of the Work, thoroughly broom clean all surfaces.

* * * * *

THIS PAGE LEFT INTENTIONALLY BLANK

SECTION 07 21 00 INSULATION

SCOPE Applicable provisions of the General and Supplementary Conditions and Division 1 govern work under this Section.

INDEX	1.1 Description	1.8 Sequencing
	1.2 Quality Assurance	1.9 Project Materials
	1.3 Submittals	2.1 Materials
	1.4 Product Delivery, Storage and Handling	3.1 Surface Conditions
	1.5 Job Conditions	3.2 Preparation
	1.6 Quality Assurance	3.3 Installation
	1.7 Pre-Application Meeting	3.4 Cleaning

PART 1 GENERAL

1.1 Description

- A. Work Included: Building insulation required for this Work includes, but is not limited to:
 - 1. Batt Insulation
 - 2. Below Grade Insulation

- B. Related Work Specified Elsewhere
 - 1. Concrete Section 03 30 00
 - 2. Masonry Section 04 20 00
 - 3. Carpentry Section 06 10 00
 - 4. Mechanical System Insulation Division 23

- C. Work Furnished by Installer
 - 1. Below grade perimeter rigid insulation by Concrete Contractor.
 - 2. Roof insulation by metal building systems
 - 3. Sound insulation at interior metal stud walls and rigid wall insulation at exterior furred walls by Gypsum Wallboard Contractor.
 - 4. Wall panel insulation by metal building system.

1.2 Quality Assurance

- A. Design Criteria: The Heating and Air Conditioning system for the Project was designed for the insulation values listed for each type of insulation in Part 2 of this Section. The Contractor will insure that all insulation used meets or exceeds those values. The Architect will order the removal of all material not meeting this Specification. All insulation will meet State Fire Code. Thickness of roof insulation supplied shall not exceed the space available that would require additional blocking, or raising of parapet, door sills, flashing or curbs.

- B. Testing: Flame spread: ASTM E 84, 25 or less.

- C. Reference Standards
 - 1. American Society for Testing and Materials (ASTM):

- a. E 84, Standard Method of Test for Surface Burning
 - b. C 1289, closed cell polyisocyanurate foam core board.
 - c. ASTM C 518 - Standard Test Method for Steady-State Thermal Transmission Properties by Means of the Heat Flow Meter Apparatus
 - d. ASTM C 177 - Standard Test Method for Steady-State Heat Flux Measurements and Thermal Transmission Properties by Means of the Guarded-Hot-Plate Apparatus
 - e. ASTM C 1338 - Standard Test Method for Determining Fungi Resistance of Insulation Materials and Facings.
 - f. ASTM E 96 - Standard Test Methods for Water Vapor Transmission of Materials.
 - g. ASTM E 283 - Standard Test Method for Determining Rate of Air Leakage Through Exterior Windows, Curtain Walls, and Doors Under Specified Pressure Differences Across the Specimen.
 - h. ASTM D 1621 - Standard Test Method for Compressive Properties of Rigid Cellular Plastics
 - i. ASTM D 1622 - Standard Test Method for Apparent Density of Rigid Cellular Plastics
 - j. ASTM D 1623 - Standard Test Method for Tensile and Tensile Adhesion Properties of Rigid Cellular Plastics
 - k. ASTM D 2126 - Standard Test Method for Response of Rigid Cellular Plastics to Thermal and Humid Aging
 - l. ASTM D 2842 - Standard Test Method for Water Absorption of Rigid Cellular Plastics.
2. Federal Specifications (FS):
- a. HH-I-521, Insulation Blankets, Thermal (Mineral Fiber for Ambient Temperatures)
 - b. HH-I-524, Insulation Board, Thermal (Polystyrene)
 - c. HH-I-1972, Insulation Board, Thermal (Urethane)
 - d. L-P-375, Plastic Film, Flexible, Vinyl Chloride

1.3 Submittals: Within 35 days after award of Contract, and before any of the materials of this Section are delivered to the job site, submit complete to the Architect in accord with the provisions of these Specifications; the following:

- A. Manufacturer's Literature: Manufacturer's recommended installation instructions.
- B. Material List: Submit to the Architect for review a complete list of all insulation material proposed to be furnished. Any material which differs from that specified, shall have engineering data submitted to show that its performance is equal to insulation specified. See Section 01 30 00.
- C. Technical Data: Submit technical data indicating thermal conductance factors of furnished insulation.
- D. Certificates: Manufacturer's certification that materials meet Specification requirements.

1.4 Product Delivery, Storage and Handling

- A. Protection: Use all means necessary to protect the materials of this Section before, during and after installation and to protect the installed work and materials of all other trades.
- B. Deliver materials to Project site in Manufacturer's original unopened packaging.

- C. Identify contents, Manufacturer, brand name, thermal values and applicable standards.
- D. Store materials in area protected from weather, moisture, and open flame or sparks.
- E. Replacements: In the event of damage, immediately replace materials at no additional cost to the Owner. Tears in foil face insulation will not be acceptable.

1.5 Job Conditions

- A. Environmental Requirements: Do not install insulation when temperature is 40 degrees F. or below, during rain or wet weather, or when surfaces are wet.
- B. Scheduling: Coordinate installation with other trades whose work may be affected or have effect.

1.6 Quality Assurance

- A. Manufacturer Qualifications: Manufacturer with a minimum of ten years' experience manufacturing products in this section shall provide all products listed.
- B. Installer Qualifications: Products listed in this section shall be installed by a single organization with at least five years' experience successfully installing insulation on projects of similar type and scope as specified in this section.
- C. Mock-Up: Provide a mock-up for evaluation of surface preparation techniques and application workmanship.
 - 1. Finish areas designated by Architect.
 - 2. Do not proceed with remaining work until workmanship is approved by Architect.
 - 3. Refinish mock-up area as required to produce acceptable work.

1.7 PRE-APPLICATION MEETINGS

- A. Convene minimum two weeks prior to starting work of this section.

1.8 SEQUENCING

- A. Ensure that products of this section are supplied to affected trades in time to prevent interruption of construction progress.

1.9 PROJECT CONDITIONS

- A. Maintain environmental conditions (temperature, humidity, and ventilation) within limits recommended by manufacturer for optimum results. Do not install products under environmental conditions outside manufacturer's absolute limits.
- B. Do not apply insulation when substrate temperatures are under 40 degrees F (4.4 degrees C) prior to installation.
- C. Surfaces must be dry prior to application of spray foam. Excess humidity may cause poor adhesion, and result in product failure.
- D. To avoid overspray, product should not be applied when conditions are windy.

PART 2 PRODUCTS

2.1 Materials (See Drawing Details for applicable products)

A. Building Insulation

1. Rigid Below Grade Insulation

- a. Adhesive: As recommended by insulation Manufacturer.
- b. Expanded polystyrene board, Type IX - 1.80 density minimum, R - 4.76 per inch at 40 degrees F.
- c. Total thickness per drawings – 2 layers with staggered joints.

2. Rigid wall insulation

- a. Adhesive: As recommended by E.I.F.S. manufacturer.
- b. Expanded polystyrene board, Type I. 0.90 pound density, R = 4.17 per inch at 40 degrees F.
- c. Thickness as shown on drawings

PART 3 EXECUTION

3.1 Surface Conditions

- A. Inspection: Prior to all Work of this Section, carefully inspect the installed work of all other trades and verify that all such work is complete to the point where this installation may be installed in accord with original design and the Manufacturer's recommendation.
 1. Examine space allocated for insulation for proper depth to receive material.
 2. Check surfaces to receive rigid insulation to assure they are in uniform plane; and free of mortar chips, debris, grease, oil or other items detrimental to installation.
- B. Discrepancies: In the event of discrepancy, immediately notify the Architect. Do not proceed with installation in areas of discrepancy until all such discrepancies have been fully resolved.

3.2 Preparation: Remove or protect against projections in construction framing that may damage or prevent proper installation.

3.3 Installation

- A. Below grade perimeter insulation: mechanically bond to concrete.
- B. Gypsum Wallboard: per manufacturer's recommendations.

3.4 Cleaning

- A. Any installer using mastic will clean all excess material from all surfaces to be exposed or to receive the work of other trades. Follow criticisms of Architect completely.

* * * * *

SECTION 07 60 00 FLASHING AND SHEET METAL

SCOPE Applicable provisions of the General and Supplementary Conditions and Division 1 govern work under this Section.

INDEX	1.1 Description	2.1 Materials
	1.2 Quality Assurance	3.1 Surface Conditions
	1.3 Submittals	3.2 Preparation
	1.4 Product Delivery, Storage and Handling	3.3 Installation
	1.5 Warranty	3.4 Repairing
		3.5 Cleaning

PART 1 GENERAL

1.1 Description

- A. Work Included: Furnish and install all flashing and sheet metal not specifically described in other Sections of these Specifications but required to prevent penetration of water through exterior shell of the buildings.
- B. Related Work Specified Elsewhere
 - 1. Sealants and Caulking Section 07 92 13
 - 2. Plumbing Division 22
 - 3. Louvers and Vents Division 22

1.2 Quality Assurance

- A. Qualifications of Installers: Provide at least one person who shall be present at all times during execution of the Work of this Section and who shall be thoroughly trained and experienced in the materials and methods required and who shall direct the entire flashing and sheet metal fabrication and installation.
- B. Mock-ups
 - 1. Before work of this Section begins, fabricate for review a one (1) ft. mock-up of the edge flashing using identical project materials and methods.
 - 2. Include seams, fasteners.
 - 3. Maintain accepted mock-up for comparison with finished work.
- C. Reference Standards
 - 1. American Society for Testing and Materials (ASTM):
 - a. A 525, Steel Sheet, Zinc-Coated (Galvanized) by the Hot-Dip Process, General Requirements
 - b. A 526, Steel Sheet, Zinc-Coated (Galvanized) by the Hot-Dip Process, Commercial Quality
 - 2. Federal Specifications (FS):
 - a. FF-S-107, Screws, Tapping and Drive
 - 3. Sheet Metal and Air Conditioning Contractors National Assn., Inc. (SMACNA)
 - a. Sheet Metal Manual

1.3 Submittals: Within 35 days after award of Contract, and before any of the materials of this Section are delivered to the job site, submit complete to the Architect in accordance with these Specifications; the following:

- A. Samples
 - 1. Two, 12 inch by 12 inch samples of each sheet metal material.
 - 2. Show pattern, finish color and thickness.

1.4 Product Delivery, Storage and Handling

- A. Protection: Use all means necessary to protect the materials of this Section before, during and after installation and to protect the installed work and materials of all other trades.
- B. Replacements: In the event of damage, immediately make all repairs and replacements necessary to the approval of the Architect and at no additional cost to the Owner.

1.5 Warranty: All sheet metal work done in conjunction with the roofing membrane shall be warranted for two years against defects in materials and workmanship.

PART 2 PRODUCTS

2.1 Materials

- A. Materials and Gages: Where sheet metal is required and no materials or gage is indicated on the Drawing, furnish and install the highest quality and gage commensurate with the referenced standards.
- B. Sheet Metal
 - 1. Aluminum:
 - a. ASTM B 209, alloy 3003, temper H14
 - b. Finish: AS-C22A41
 - c. Minimum thickness of gage: 0.032 inches
 - 2. Wall Cap:
 - a. Base Clip: 22 gauge galvanized steel, ASTM A 526 commercial quality, coating - G-90, ASTM A 525.
 - b. Cap" Prefinished galvanized steel, 24 gauge, with Kynar 500 coating, smooth surface. "Colorklad" by Vincent Metals, color as selected from all standard colors.
 - 3. Galvanized Steel:
 - a. ASTM A 526, commercial quality
- C. Fasteners:
 - 1. Nails: galvanized, flathead roofing nails.
 - 2. Screws: Self-tapping sheet metal type, FS FF-S-107.
- D. Gutters and Downspouts
 - 1. Seamless stock 6" aluminum with 5" x 6" stock rectangular downspouts. Pipe covers at grade connection to pipe.
 - 2. Color as selected.

E. Standing Seam Roofing: Butler VSR Roof System or equal; installation per manufacturer standards/industry. Color as Selected by Architect

1. Panel Description

- a. Panels shall be produced on a precision roll forming machine.
- b. Panels of maximum possible lengths shall be used to, minimize end laps. Standard lengths shall be used to a nominal 40 foot (shipping restrictions).
- c. Roof panels shall be factory pre-punched at panel end to match pre-punched holes in the eave structural member. Panel end splices shall be pre-punched and pre-notched.
- d. Profile: Edges: Male/female, Double lock standing seam
- e. (2) Rows of snow guards staggered on roof edge.
- f. Ice and Water Shield: ASTM D146, 60 mil, adhesive backed membrane, 36 inches wide over complete sub roof by this contractor.

2. Panel Design:

- a. Panels shall be designed in accord with AISI Specifications for the Design of Light Gage Cold Formed Steel Structural Members and in accord with sound engineering methods and practices.
- b. Panels shall be designed to support design live loads and roof traffic during construction.
- c. The roof shall provide for expansion/contraction without detrimental effect on the roof panel when ambient air temperature varies ± 100 degrees F. from the temperature at which the roof was installed.

3. Panel Material

- a. 24 gage galvanized steel (42,000 yield) conforming to ASTM A 525. Coating shall be G-90 to ASTM A 446 grade D or A 515.
- b. Gage aluminized steel - Type II MIL-S-4174A.
- c. Inch aluminum sheet.

F. Siding: UNI-RIB – MBCI Signature 300 – Allow for two colors per elevations for the building and a third color for the trim. Colors by as selected by Architect.

1. Material and Finish: 26 Gauge, ASTM A 653 (A 653 M), Structural Quality, Grade 80 (550) (formerly Grade E), galvanized steel with G60 (Z180) zinc coating both sides, Triple Spot Test.

a. Exterior Surface Finish:

- 1) Bonderize and provide baked on primer and factory applied, baked-on 70% Kynar 500 or Hylar 5000 PVDF fluoropolymer resin based Fluoropon paint coating as manufactured by Valspar, 0.9 mil (0.023 mm) minimum dry film thickness.
- 2) Gloss (60 Degrees): ASTM D523, 20 to 80.
- 3) Pencil Hardness: ASTM D3363, F to 2H.
- 4) T-Bend: ASTM D4145: 2T to 4T.

2. Configuration:

- a. Roll-formed; 36 inch (915 mm) coverage width. Provide panels covering up to 35 foot (10.5 m) lengths in single pieces.
- b. Four major corrugations, 7/8 inch (22 mm) high, spaced 12 inches (305 mm) on center with 3 minor corrugations, 1/8 inch (3 mm) high, spaced 3 inches (76 mm) on center between each major corrugation.
- c. Form one outboard corrugation as overlapping corrugation.
- d. Form opposite outboard corrugation as underneath corrugation with full return leg to support side lap and a continuous anti-siphon drain channel.
- e. Factory cut to required length.
- f. Factory miter cut gable ends.

- g. Material and Finish: As shown on Erection Drawings, except as specified herein.
 - h. Fasteners: Color coated No. 10 piercing screws with 1/4 inch (6 mm) hex head pre-assembled to 1/2 inch (13 mm) O.D. dome seal or bond seal galvanized steel and EPDM washers.
3. Siding Accessories:
- a. Wall Trim and Flashings: Provide manufacturer's standard pre-engineered wall trim and flashings.
 - b. Louvers: Manufacturer's standard sheet metal unit with 1/2 inch (13 mm) hardware cloth screen, pre-finished enamel in color selected from Lester standard colors, 18 x 24 inch (457 x 610 mm) size.
 - c. Closure Strips: Closed cell, 2 pcf (32 kg/m³) density polyethylene foam, pre-molded to match configuration of panels.
 - d. Material and Finish: As shown on Erection Drawings, except as specified herein.
- G. Soffit Panels: Marquee–Lok Panel or equal - 12" wide flat panel, minimum 1 inch metal thickness; crimped profile. Color as selected by Architect.

PART 3 EXECUTION

3.1 Surface Conditions

- A. Inspection Prior to all Work of this Section, carefully inspect the installed work of all other trades and verify that all such work is complete to the point where this installation may properly commence. Verify that flashing and sheet metal may be installed in accord with the original design, all pertinent codes and regulations, the reference standards, and the approved Shop Drawings.
- 1. Verify that substrates are smooth and clean to extent needed for sheet metal Work.
 - 2. Verify that reglets, nails, cants and blocking to receive sheet metal are installed and free of concrete and soil.
- B. Discrepancies: In the event of discrepancy, immediately notify the Architect. Do not proceed with installation in areas of discrepancy until all such discrepancies have been fully resolved.

3.2 Preparation: Before installing sheet metal verify shapes and dimensions of surface to be covered.

3.3 Installation

- A. General
- 1. Install work watertight, without waves, warps, buckles, fastening stresses or distortion, allowing for expansion and contraction.
 - 2. Angle bottom edges of exposed vertical surfaces to form drips.
- B. Reglets: Install in accurate locations, straight, in-line and with leak proof joints.
- C. Sealant Installation: Apply 1/4 inch diameter bead, centered on full length of joint.

D. Roof Counterflashing

1. Overlap base flashing 4 inch minimum.
2. Install bottom edge tight against base flashing.
3. Lap seam vertical joints 3 inch minimum and apply sealant.
4. Miter, lap seam and close corner joints with solder or sealant.

E. Copings

1. Space drive lock or cover plate seam 8 feet apart maximum.
2. Miter and join corners with seams to match others in coping.
3. Parapet Walls
 - a. Lock exterior edges over continuous cleats secured to substrate.
 - b. Slope 3/4 in 12 toward inside of parapet.
 - c. Lock interior edges to substrate with cleats anchored at seams.

F. Roof Cap

1. Form gravel stop 3/4 inch minimum height.
2. Fabricate joints with lap seams spaced 10 feet apart, maximum.
3. Fill roof flange joints with bituminous plastic cement.
4. Lock drip edge over continuous cleats secured to substrate.
5. Extend roof flange 4 inches on top of roofing, set in plastic cement bed and secure to substrate with nails spaced apart.
6. Miter and bend round corners 12 inches minimum.
7. Provide at built-up roofing edges raised less than 3-1/2 inches above roof deck substrate.

G. Roof Penetration Flashing

1. Base Flashing
 - a. Extend flange onto roof 6 inches minimum away from penetration.
 - b. Extend flange upward around penetration to at least 8 inches above roofing felts.
 - c. Fold back upper and side roof flange edges 1/2 inch minimum.
 - d. Solder-lap joints.
2. Counterflashing
 - a. Overlap base flashing one inch minimum with storm collar sloped away from penetration.
 - b. Secure to penetration with draw band and sealant.

H. Equipment Support Flashing

1. Full cap support.
2. Overlap base flashing 4 inches.
3. Solder-lap joint.
4. Provide sealant around penetration through flashing.

I. Gutters and Downspouts

1. Install where shown on drawings.
2. Provide metal cap at pipe connection at grade.

3.4 Repairing: Repair or replace damaged work at no additional cost to the Owner.

3.5 Cleaning

- A. As work progresses, neutralize excess flux with 5 to 10% washing soda solution and thoroughly rinse.

B. Leave work clean and free of stains, scrap and debris.

* * * * *

SECTION 07 92 13 SEALANTS AND CAULKING

SCOPE Applicable provisions of the General and Supplementary Conditions and Division 1 govern work under this Section.

INDEX	1.1 Description	2.1 Caulking Materials
	1.2 Quality Assurance	2.2 Caulking Equipment
	1.3 Submittals	2.3 Acceptable Manufacturers
	1.4 Product Delivery, Storage and Handling	3.1 Surface Conditions
	1.5 Warranty	3.2 Preparation
		3.3 Installation
		3.4 Caulking Schedule

PART 1 GENERAL

1.1 Description

- A. Work Included
1. The purpose of caulking in this work is to provide a positive barrier against penetration of air and moisture at joints between items where caulking is essential to continued integrity of the barrier.
 2. Such caulking will normally be performed under the work of various Sections of these Specifications but shall be performed in strict accord with the provisions of this Section.
 3. Exterior of Building: Joints and cracks around windows, aluminum entrances, door frames, columns, louvers, wall penetrations, connections and other joints necessary to seal off building from outside air and moisture.
 4. Interior of Building:
 - a. Inside jambs and heads of exterior door frames.
 - b. Interior hollow metal doorframes. Both sides of interior hollow metal frames at exposed masonry or precast concrete.
 - c. Inside perimeter of windows.
 - d. Glass sound seal as detailed on drawings for wall butting exterior glazing (by Glazing Contractor).
 - e. Polished concrete floors – control joints by polished concrete floor contractor (Caulk all joints at polished floor areas)
- B. Related Work Specified Elsewhere: Individual requirements for caulking are described in various other Sections of these Specifications.
- | | |
|-----------------------------|------------------|
| 1. Concrete | Section 03 30 00 |
| 2. Masonry | Section 04 20 00 |
| 3. Flashing and Sheet Metal | Section 07 60 00 |
| 4. Glazing | Section 08 80 00 |

1.2 Quality Assurance

- A. Qualifications of Applicators: Installation of caulking shall be performed only by workers thoroughly skilled and specially trained in the techniques of caulking, and who are completely familiar with the published recommendations of the manufacturer of the caulking materials being used. Minimum two years' experience and approved by manufacturer.

- B. Rejection of Installed Caulking: Indication of lack of skill on the part of caulking installers shall be sufficient ground for the Architect to reject installed caulking and to require its immediate removal and complete re-caulking at no additional cost to the Owner. This item will be strictly enforced and no excuses accepted.
- C. Manufacturer's Representative: Arrange for manufacturer's technical representative to be on project site to advise installer of proper procedures and precautions for the use of materials and to check installation.
- D. Reference Standards
 - 1. American Society for Testing and Materials (ASTM):
 - a. C 790, Recommended Practices for Use of Latex Sealing Compounds.
 - b. C 804, Recommended Practice for Use of Solvent-Release Type Sealants.
 - c. C 920, Elastomeric joint sealants.
 - d. D 1056, Flexible Cellular Materials - Sponge or Expanded Rubber.
 - e. D 1565, Flexible Cellular Materials - Vinyl Chloride Polymers and Co-polymers (Open Cell Foam).

1.3 Submittals: Within 35 days after award of Contract, and before any of the materials of this Section are delivered to the job site, submit complete to the Architect in accord with the provisions of these Specifications; the following:

- A. Product Data: Copies of product manufacturer's specification, recommendations and installation instructions for sealant, backing and associated materials.

1.4 Product Delivery, Storage and Handling

- A. Protection: Use all means necessary to protect the materials of this Section before, during and after installation and to protect the installed work and materials of all other trades.
- B. Delivery of Materials: Deliver materials in original, tightly sealed containers or unopened packages with Manufacturer's name, labels, product identification and lot numbers where appropriate.
- C. Replacements: In the event of damage, immediately make all repairs and replacements necessary to the approval of the Architect and at no additional cost to the Owner.

1.5 Warranty

- A. Provide Manufacturer's standard year 10 material warranty. Replace sealants which fail because of loss of cohesion or adhesion, or do not cure.
- B. Guarantee workmanship against leakage for two years.

PART 2 PRODUCTS

2.1 Caulking Materials: All caulking materials shall be a single or double component, non-sagging type.

A. Sealants

1. Silicone base, solvent curing conforming to requirements of C 920, Type S; Grade NS; Class 25; Use NT; Shore 'A' hardness of minimum 15 and maximum 50; non-staining; non-bleeding; color as selected.
2. Polyurethane base, multi-component, chemical curing; self leveling type for application in horizontal joints and non-sagging type for application in vertical joints; capable of being continuously immersed in water, withstand movement of up to 25 percent of joint width and satisfactorily applied throughout a temperature range of 40 to 80 degrees F.; uniform, homogeneous, and free from lumps, skins and coarse particles when mixed; Shore 'A' hardness of minimum 15 and maximum 50; non-staining; non-bleeding; color as selected.

B. Accessories

1. Primer: Non-staining type, as recommended by sealant Manufacturer to suit application.
2. Joint Cleaner: Non-corrosive and non-staining type, recommended by sealant Manufacturer; compatible with joint forming materials.
3. Joint Filler: as recommended by sealant manufacturer to suit application.
4. Bond Breaker: Pressure sensitive tape recommended by sealant Manufacturer to suit application.
5. Masking Tape: Pressure sensitive adhesive paper tape.

2.2 Caulking Equipment: All caulking equipment shall be only such equipment as is specifically recommended by the manufacturer of the caulking material being installed.

2.3 Acceptable Manufacturers

- A. Dow Chemical
- B. General Electric
- C. Tremco

PART 3 EXECUTION

3.1 Surface Conditions

A. Inspection

1. Prior to all Work of this Section, carefully inspect the installed work of all other trades and verify that all such work is complete to the point where this installation may properly commence.
2. Verify that caulking may be installed in accord with the manufacturer's recommendations.
3. Examine joints to be sealed for construction defects which would adversely affect execution of work.
4. Ensure that masonry and concrete have cured 28 days minimum.

B. Discrepancies

1. In the event of discrepancy, immediately notify the Architect.
2. Do not proceed with installation in areas of discrepancy until all such discrepancies have been fully resolved.

3.2 Preparation

- A. Cleaning: Clean joint surfaces, using joint cleaner as necessary to be free of dust, dirt, oil, grease, rust, lacquers, laitance, release agents, moisture, or other matter which might adversely affect adhesion of sealant.
- B. Do not apply caulking to painted surfaces. Remove old paint and caulking material before applying new caulking.
- C. Masking: Mask area adjacent to joints.
- D. Very porous surfaces require priming.
- E. Before caulking, clean and prime surfaces to receive caulking per manufacturer's recommendations.
- F. Verify that joint shaping materials and release tapes are compatible with sealant.
- G. Examine joint dimensions and size materials to achieve required width/depth ratios.
- H. Use joint filler to achieve required joint depths, to allow sealants to perform properly.
- I. Use bond breaker where required.

3.3 Installation

- A. Application of Backing
 - 1. Verify the compatibility of filler material with caulking before installation.
 - 2. Polyurethane for open joints shall be at least 1-1/2 times width of open joint and of thickness to give solid backing.
 - 3. Backing shall fill up joint do depth of joint is approximately 1/2 of its width for joints from 1/2" to 1".
 - 4. Install backing material in joints using blunt instrument to avoid puncturing. Do not twist rod while installing. Install backing so that joint depth is 50% of joint width, but a minimum of 1/4" deep.
- B. Mixing: (Two Part)
 - 1. Mix in exact proportions recommended by Manufacturer.
 - 2. Do not thin.
 - 3. Secure a perfect blend by thorough slow mixing.
 - 4. Mix five minutes mechanically (one gallon units) or ten minutes by hand.
 - 5. Do not mix in direct sunlight.
- C. Application of Caulking
 - 1. General:
 - a. Do not caulk under weather conditions or sun conditions potentially harmful to the set and curing of the caulking material.
 - b. Perform work in accord with ASTM C 804 for solvent release.

2. Installation

- a. Install caulking in strict accord with the manufacturer's recommendations, taking care to produce beads of proper width and depth, to tool as recommended by the manufacturer, and to immediately remove all surface caulking.
- b. Apply with hand caulking gun. Use gun nozzles of proper size to fit joints.
- c. A minimum adhering surface should be at least 1/2". For joints from 1/2" to 1" wide, depth of sealant shall be 1/2 the width. For joints over 1", maintain depth of sealant to 1/2". (For unusual requirements, consult supplier.)
- d. Seal joint when it is normal; not in a contracted or expanded condition.
- e. Use masking tape to protect surrounding surfaces. Remove tape immediately after drawing bead with inner edge drawn away first to eliminate feather edging.
- f. Tool with putty knife of suitable size within 10 minutes after gunning. Tool may be moistened with solvent to avoid sticking. Tool joints as indicated.
- g. Do not apply caulking at temperatures under 50 degrees F.
- h. Caulk entire perimeter of all openings unless otherwise indicated.
- i. Joints: Free of air pockets, foreign embedded matter, ridges and sags.

D. Cleaning: Remove excess materials adjacent to joints by mechanical means or with xylol (xylene) or mineral spirits as work progresses to eliminate evidence of spillage or damage to adjacent surfaces. Note: When using flammable solvents, avoid heat, sparks and open flames. Always provide adequate ventilation and follow all precautions listed on solvent container label. Leave finished work in neat, clean condition with no evidence of spillovers onto adjacent surfaces.

3.4 Caulking Schedule

- A. Carefully study the Drawings and furnish and install the proper caulking of each point where called for on the Drawings plus all other points where caulking is essential in maintaining the continued integrity of the watertight barrier. In general, caulk all joints of masonry meeting non-masonry surfaces including interior and exterior door and window frames, caulk all masonry expansion joints.
 - 1. Silicone base, "Silicone": Glazing systems, toilet rooms.

* * * * *

THIS PAGE INTENTIONALLY LEFT BLANK

SECTION 08 11 00 METAL DOORS AND FRAMES

SCOPE Applicable provisions of the General and Supplementary Conditions and Division 1 govern work under this Section.

INDEX	1.1 Description	2.2 Materials
	1.2 Quality Assurance	2.3 Fabrications
	1.3 Submittals	2.4 FRP Faced/Alum Doors
	1.4 Product Delivery, Storage and Handling	3.1 Inspection
	2.1 Acceptable Manufacturers	3.2 Installation
		3.3 Adjustment and Cleaning

PART 1 GENERAL

1.1 Description

A. Work Included

1. The metal doors and frames required for this work are indicated on the Drawings and include non-labeled and labeled hollow metal doors and frames and hollow metal frames for borrowed lites.
2. FRP faced aluminum doors noted as "FRP" on door schedule.

B. Related Work Specified Elsewhere

- | | |
|-----------------------|------------------|
| 1. Metal Fabrications | Section 05 50 00 |
| 2. Metal Door Frames | Section 08 11 00 |
| 3. Finish Hardware | Section 08 71 00 |
| 4. Glazing | Section 08 80 00 |
| 5. Finish Painting | Section 09 91 00 |
| 6. Electrical | Division 26 |

1.2 Quality Assurance

- A. Qualifications of Installers: For actual installation of metal doors and frames and installation of finish hardware on metal doors and frames, use only personnel who are thoroughly trained and experienced in the skills required and who are completely familiar with the Manufacturer's current recommended methods of installation as well as the requirements of this Work. Minimum two years experience.
- B. Requirements of Regulatory Agencies
1. Testing agency: Underwriters Laboratories, Inc.
 2. Door assembly fire test
 - a. Procedure: ASTM E 152.
 - b. Exposure: As labeled on Door Schedule.
- C. Reference Standards
1. American National Standards Institute (ANSI):
 - a. A 115, Series on Door and Frame Preparation.
 - b. A 151.1, Performance Test for Standard Steel Doors, Frames, Anchors, Hinge Reinforcing and Exit Device Reinforcings.

2. Hollow Metal Manufacturers Association (HMMA)
 - a. Standard 800, Hollow Metal Manual
3. Steel Door Institute (SDI)
 - a. 100, Recommended Specification, Standard Steel Doors and Frames.
 - b. 105, Recommended Erection Instructions for Steel Frames.
 - c. 107, Hardware on Steel Doors, (reinforcement application).
 - d. 110, Standard Steel Doors and Frames for Modular Masonry Construction.
 - e. 113, Standard Thermal Performance Tests ply Steel Door and Frame Assemblies.
4. In addition to complying with all pertinent codes and regulations:
 - a. Manufacturer all labeled doors in strict accord with the specifications and procedures of Underwriters' Laboratories, Inc.
 - b. In Warranty and Shop Drawings, comply with nomenclature established in American National Standards Institute publication A 123.1 "Nomenclature for Steel Doors and Steel Door Frames".

1.3 Submittals: Within 35 days after award of Contract, and before any of the materials of this Section are delivered to the job site, submit complete to the Architect in accordance with these Specifications; the following:

- A. Samples
 1. A sample of door, showing edge, top and/or bottom construction, insulation, hinge reinforcement and face stiffening.
 2. A sample of a typical frame, showing welded corner joint, welded hinge reinforcements, dust cover boxes and floor anchor.
 3. All samples submitted shall be of the production type and shall represent in all respects the minimum quality of work to be furnished by the Manufacturer. No work represented by the samples shall be fabricated until the samples are approved and any downgrading of quality demonstrated by the samples may be cause for rejection of the work.
- B. Shop Drawings: Illustrations and schedule of door and frame sizes, types, materials, construction, finishing, anchoring, accessories and preparation for installing hardware.
- C. Product Data: Manufacturer's descriptive literature and installation instructions.
- D. Certificates: Manufacturer's certificates that materials meet specification requirements.

1.4 Product Delivery, Storage and Handling

- A. Protection:
 1. Deliver, store and handle all metal doors and frames in a manner to prevent damage and deterioration.
 2. Provide packaging such as cardboard or other containers, separators, banding, spreaders and paper wrappings as required to completely protect all metal doors and frames during transportation and storage.
 3. Store doors upright, in a protected dry area, at least one inch off the ground and with at least 1/4" air space between individual pieces; protect all prefinished and hardware surfaces as required.
- B. Replacements: In the event of damage, immediately make all repairs and replacements necessary to the approval of the Architect and at no additional cost to the Owner.

PART 2 PRODUCTS

2.1 Acceptable Manufacturers: All metal doors and frames shall be the product of one Manufacturer.

- A. Hollow metal doors and frames - Pioneer, Amweld, Ceco, Kewanee, Republic, Precision, Steelcraft, Curries.
- B. FRP/Aluminum
 - 1. Series 100BE FRP, Cline Aluminum Doors, Bradenton, FL
 - 2. D9 heavy duty doors, U.S. Metal & Mfg. Corp, South Bend, IN
 - 3. SL-17 FRP Flush, Special-Lite, Inc. Decatur MI
 - 4. Flushline Series "FRP Faced", Kawneer Co., Inc., Frankline, WI.

2.2 Materials (Hollow Metal)

- A. Steel Fabrications: Carbon Steel: Cold rolled, ASTM A 366.
- B. Coating Materials: Primer: Manufacturer's standard rust inhibitive primer.
- C. Core Filler Material: Manufacturer's standard.
- D. Anchors, Fasteners, Hardware and Accessories: Manufacturer's standard.

2.3 Fabrication (Hollow Metal)

- A. General
 - 1. Fabricate hollow metal work to be rigid, neat in appearance and free from defects, warp or buckle.
 - 2. Completed fabrications to meet ANSI A 151.1.
 - 3. Accurately form metal to required sizes and profiles, including astragals if utilized.
 - 4. Clearly identify work that cannot be permanently factory assembled before shipment, to assure proper assembly at project site.
 - 5. Grind and dress exposed welds to form smooth, flush surfaces.
 - 6. Do not use metallic filler to conceal manufacturing defects.
- B. Doors
 - 1. Form interior face sheets of 18 gauge and exterior face sheets of 16 gauge metal.
 - 2. Stiffener
 - a. Stiffen face sheet with continuous vertical formed steel sections over full thickness of interior space between door faces.
 - b. Stiffeners of 22 gauge minimum spaced not more than 6 inches apart, spot welded to both face sheets not more than 4 inches on center.
 - c. Fill spaces between stiffeners with core material.
 - 3. Join door faces at vertical edges by continuous weld extending full height of door, grind welds flush.
 - 4. Form astragal on meeting edge of door.
 - 5. Close top and bottom edges of doors with steel channel minimum 16 gauge, extending full width of door and spot welded to both faces.
 - 6. Form door seal mortise on door bottom.

7. Edge profiles shall be provided on both vertical edges of doors as follows:
 - a. Single-acting swing doors - beveled 1/8 inch in 2 inches.
 - b. Double-acting swing doors - rounded on 2-1/8 inch radius.
8. Hardware reinforcements
 - a. Doors shall be mortised, reinforced, drilled and tapped at the factory for fully template hardware only, in accord with the approved hardware schedule and templates provided by the hardware contractor. Where surface-mounted hardware is to be applied, doors shall have reinforcing plates only; all drilling and tapping shall be done by others.
 - b. Minimum gages for hardware reinforcing plates shall be as follows:
 - (1) Hinge and pivot reinforcements: 7 gauge
 - (2) Reinforcements for lock face, flush bolts, concealed holders, concealed or surface-mounted closers: 12 gauge
 - (3) Reinforcements for all other surface-mounted hardware: 16 gauge
9. Vision Panels
 - a. Framed for glazing
 - b. Glazing beads:
 - (1) Manufacturer's standard mitered corners.
 - (2) Form beads from minimum 20 gauge metal, prefitted for field glazing.
 - (3) Locate beads on nonsecurity side of opening.
 - (4) Locate screws within one inch of ends of beads and spaced not more than 8 inches apart.

C. Frames

1. Anchors: T-strap or stirrup strap type.
2. Dust cover boxes: Minimum 26 gauge at hardware mortises.
3. Welded frames
 - a. 14 gauge exterior and 16 gauge interior minimum.
 - b. Weld frames to form rigid, neat, square and true units free of defects, warp or buckle.
 - c. Close corner joints tight with trim faces mitered and continuously welded and ground smooth.
 - d. Weld temporary steel brace to both feet of jambs to serve as brace during shipping handling.
 - e. Head assemblies integrally reinforced and mitered joints with 18 gauge minimum channel section.

D. Edge Clearances

1. Between doors and frame at head and jamb: 1/8 inch.
2. At sills without thresholds: 3/4 inch maximum.
3. At sills with thresholds: 1/4 inch maximum between threshold and door.
4. Between meeting edges of pairs of doors: 1/8 inch.

E. Preparation for Hardware: ANSI A 115.

F. Finish

1. Dress tool marks and surface imperfections to smooth surfaces and remove irregularities.
2. Chemically treat and clean doors and frames.
3. Apply Manufacturer's standard prime and finish coating. Frames to be painted by the dipping process.

2.4 FRP Faced/Aluminum Doors

- A. Doors shall be 1-3/4" in thickness of true 5-ply construction. The core shall be ICO - 25 polyisocyanurate foam,. Closed cell, with a density of 2# cu. ft. internal hardware backup shall be full perimeter aluminum tube, 4-1/2" width, .125 wall thickness. (Bronze color door and frame)
- B. Doors shall be constructed of one piece .90" glass fiber laminate (FRP) with a pebble-like, Bronze embossed pattern. ASTM Standard Specification for Glass Fiber D-3841. Reinforced Polyester Plastic Panels Type II, bonded to 0.75" tempered hardboard.
- C. Entire perimeter of door shall be furnished with beveled edge design aluminum extrusion 6063-T5 alloy to receive glass fiber panel and backer board. Doors shall have oil-tempered hardboard the full width of the doors. Wool pile weather-stripping the full perimeter of the door.
- D. Glazing, if any, for 1/4" thick glass with snap-in non-removable stops of extruded aluminum 6063-T5, minimum thickness .050". Vinyl insert shall be used for sealing.

PART 3 EXECUTION

3.1 Inspection

- A. Assure that frame openings correspond to dimensions of frame furnished.
- B. Check that surfaces to contact frame are free of debris.
- C. Verify that metal doors and frames may be installed in strict accord with all pertinent codes and regulations, the original design, approved Shop Drawings and Manufacturer's recommendations.
- D. Discrepancies
 - 1. In the event of discrepancy, immediately notify the Architect.
 - 2. Do not proceed with installation in areas of discrepancy until all such discrepancies have been fully resolved.

3.2 Installation

- A. Anchorage
 - 1. Attach anchor to opening.
 - 2. Minimum number of anchors.
 - a. Masonry walls.
 - (1) Frames up to 7 feet 6 inches: 3 anchors per jamb.
 - (2) Frames 7 feet 6 inches to 8 feet 0 inches: 4 anchors per jamb.
 - (3) Frames more than 8 feet 0 inches: 1 anchor for each 2 feet of jamb or fraction thereof.
 - b. Stud partitions
 - (1) Frames up to 7 feet 6 inches: 3 anchors per jamb.
 - (2) Frames 7 feet 6 inches to 8 feet 0 inches: 4 anchors per jamb.
 - (3) Frames more than 8 feet 0 inches: 4 anchors plus one additional anchor for each 2 feet of jamb or fraction thereof.

- B. Frames
 - 1. Remove shipping spreaders if used.
 - 2. Attach frames square, plumb and true to line with adjacent construction.
 - 3. Frames to be mortar filled by mason.
- C. Finish Hardware: Install all finish hardware supplied under Section 08 71 00 in strict accord with the Manufacturer's recommendations, eliminating all hinge-bound conditions and making all items smoothly operating and firmly anchored into position.
- D. Doors: SDI 100.
- E. Installation: Install hollow metal work in accordance with Manufacturer's instructions.

3.3 Adjustments and Cleaning

- A. Remove dirt and excess sealants or glazing compound from exposed surfaces.
- B. Touch up marred or abraded surfaces to match original finish.
- C. Adjust moving parts for smooth operation.
- D. Remove debris from project site.

* * * * *

SECTION 08 30 00 SPECIAL DOORS

SCOPE Applicable provisions of the General and Supplementary Conditions and Division 1 govern work under this Section.

INDEX	1.1 Description	2.1 Materials
	1.2 Quality Assurance	2.2 Acceptable Manufacturers
	1.3 Submittals	3.1 Surface Conditions
	1.4 Product Delivery, Storage and Handling	3.2 Installation
	1.5 Warranty	3.3 Touching Up 3.4 Instructions

PART 1 GENERAL

1.1 Description

- A. Work Included: Special doors required for this Work are indicated on the Drawings and include, but are not necessarily limited to:
1. Electrically Operable, Insulate Overhead Sectional Doors.
 2. Operable Coiling Door.
 - a. Electrically Operated and Manual
 - b. Insulated and Non-Insulated
 - c. Rated and Non-Rated
 3. Operable Counter Shutter Doors.
 - a. Electrical Operated and Manual
 - b. Rated and Non-Rated
- B. Related Work Specified Elsewhere
- | | |
|---|------------------|
| 1. Concrete | Section 03 30 00 |
| 2. Finish Painting | Section 09 91 00 |
| 3. Electrical Hook-up (line voltage by electrical contractor and low voltage by door contractor). Door contractor to supply all equipment to Electrical contractor. | Division 26 |

1.2 Quality Assurance

- A. Qualifications of Installers: For actual installation of the special door, use only personnel who are thoroughly trained and experienced in installation of the selected products and who are completely familiar with the requirements of this Work.
- B. Requirements of Regulatory Agencies: In addition to meeting all local standards and codes, comply with the provisions of Standards of the American Rolling Door Institute, National Electrical Manufacturer's Association and Factory Mutual.
- C. Reference Standards
1. American Society for Testing and Materials (ASTM):
 - a. A 526, Steel Sheet, Zinc Coated (Galvanized) by the Hot Dip Process, Commercial Quality.
 2. American Institute of Steel Construction - "Manual of Steel Construction".
 3. American Iron and Steel Institute - "Light Gage Steel Design Manual".

4. American Welding Society - "Code for Arc and Gas Welding".
5. Metal Building Manufacturer Association - "Recommended Design Practices Manual".
6. Aluminum Association - "Aluminum Construction Manual".

D. Design Criteria

1. The intended design wind load for the Exterior doors to be 90-MPH.

1.3 Submittals: Within 35 days after award of Contract, and before any of the materials of this Section are delivered to the job site, submit complete to the Owner in accordance with these Specifications; the following:

- A. Shop Drawings: Indicate pertinent dimensioning, general construction, component connections and details, anchorage methods, hardware locations and installation details.
- B. Operation and Maintenance information.

1.4 Product Delivery, Storage and Handling

- A. Protection: Use all means necessary to protect the materials of this Section before, during and after installation and to protect the installed work and materials of all other trades.
- B. Deliver doors in Manufacturer's packaging complete with installation instructions.
- C. Replacements: In the event of damage, immediately make all repairs and replacements necessary to the approval of the Owner and at no additional cost to the Owner.

1.5 Warranty: Doors and motors - one year on workmanship and materials.

PART 2 PRODUCTS

2.1 Materials

- A. Electrically Operable Insulated Overhead Sectional Doors
 1. Door Panels: Panels shall be 3" thick, roll formed from commercial quality hot dip galvanized steel per ASTM A-525 and A-526. Door sections constructed of 26 gauge interior and exterior skins-mechanically interlocked and pressure bonded to a 2-7/8 inch thick expanded polystyrene core. The minimum door R value needs to meet the Raynor R17. Interior and exterior skins to be separated by a continuous dual durometer vinyl extrusion to form an effective thermal break and complete weather tight seal along section joint. Thermal break extrusion to be held in place by means of a mechanical interlock. End stiles to be minimum 14 gauge, separated from exterior skin with vinyl thermal break. Built in backup plates for attaching all end style hardware to be minimum 14 gauge. Backup plates for attaching all other hardware to be minimum 16 gauge.
 2. Finish: Exterior and interior of door skins pre-coated prior to roll forming with a two coat process of baked on Kynar Beige finish over epoxy primer. Kynar paint on exterior/polyester paint on inside of sectional doors is acceptable.
 3. All overhead doors to have lift clearance type track operation.
 4. Weatherstripping: Doors to be furnished with complete weatherstripping system to reduce air infiltration. Top of door provided with EPDM rubber sealing strip.

- Bottom of door to have flexible U-shape vinyl seal encased in extruded aluminum retainer to conform to irregularities in floor. Jamb seal to be EPDM rubber blade type attached to track angle mounting with rigid vinyl snap-on extrusion. Weatherstripping to be replaceable without removal of track, angle mounting or door hardware. Maximum air leakage per foot of door perimeter (floor, jamb, and header) shall not exceed .81 CFM @ 25 M.P. H. when tested in accordance with ASTM E-283. Section 2.1-A-5 Weather / Sensing Edge and Section 2.1-A-10(a) Electric Operators:
5. Both sensing edge and photo eye are required for all doors under this section.
 6. Track: All tracks to be galvanized 3" type 11 gauge. Track to have Graduated Seal for weather tight closing. Tracks to be continuous angle mounted and fully adjustable for sealing door to jamb. Continuous angle size to be not less than 3-1/2" x 6" x 1/8" – 3" tracks. Horizontal track to be adequately reinforced with continuous angle. **Installation to be for operation as high as possible to room framing.**
 7. Hardware: All hinges and brackets made from galvanized hardened steel balls per roller (3"). Cylinder locks at manual doors only.
 8. Springs: Heavy duty 250,000 cycle oil tempered wire torsion springs on continuous ball bearing cross header shaft. Galvanized aircraft type lifting cables with minimum safety of 7 to 1.
 9. Wind Load: Doors designed to withstand 20 lbs. per square foot. Deflection of door in horizontal position to be maximum 1/120 of door width.
 10. Glazing: Lite inserts to be 24" x 8" thermal type, 5/8" insulated glass. Glass unit to be encased in one piece vulcanized EPDM rubber frame. All doors to have lites in third section – maximum quantity available as per door width. Doors under 10 ft. wide use 2 vision strips. Doors over 10 ft. wide use 4 vision strips.
 11. Electric Operators:
 - a. Shall be Raynor RGJH 4435R4 gearhead drive, jackshaft type with chain hoist – 460 volts, 3 phase. Verify with electrical drawings. Horse power determined by door size. All doors to have electric Millers safety edge to stop and reverse door upon striking an object and photo safety eyes. Activation Station – 1-3 button open close and stop Nema 1 surface mounted with 24 volt circuit. Motion loop detectors to open doors only where indicated on plans. Timers to close door, by overhead door contractor. Required at all doors.
 - b. Overhead doors at wash bay should be controlled by key reader. Reader by Fuel Distribution Contractor Section 11 11 28. This contractor to provide all wiring and interfacing. Car wash photo eyes required at wash bay Model #6080203.
 12. Wiring: All electrical wiring to be done by electrical contractor. Door Contractor to supply all materials necessary to Electrical Contractor. Low voltage wiring by Door Contractor. See details on electrical sheets.

B. Operable Coiling Doors

1. General
 - a. Curtain:
 - (1) Slats: No. 5F, 22 gauge for doors up to 14'-4" wide, 20 gauge for doors between 14'-4" and 25'-4" wide, Grade 40, ASTM A 653 (A 653M), Commercial Quality, galvanized steel with G-90 (Z 275) zinc coating.
 - (2) Bottom Bar: Two 2x2x1/8 inch (50x50x3.2 mm) structural steel angles.
 - (3) Fabricate interlocking sections with high strength nylon endlocks for doors up to 16'x16' and cast iron endlocks for larger doors on alternate slats each secured with two 1/4" rivets. Provide windlocks as required to meet design windload.

- (4) Slat Finish – Galvanized Steel: Phosphate treatment followed by baked-on polyester powder coat, color as selected by Architect from manufacturer's standard color range, minimum 32 colors; minimum 2.5 mils (0.065 mm) cured film thickness; ASTM D-3363 pencil hardness: H or better.
 - (5) Bottom Bar Finish – Steel : Phosphate treatment followed by baked-on polyester powder coat, color as selected by Architect from manufacturer's standard color range, minimum 32 colors; minimum 2.5 mils (0.065 mm) cured film thickness; ASTM D-3363 pencil hardness: H or better.
 - b. Guides: Fabricate with minimum 3/16-inch (5mm) structural steel angles. Provide windlock bars of same material when windlocks are required to meet design wind load. Top of inner and outer guide angles to be flared outwards to form bellmouth for smooth entry of curtain into guides. Provide removable guide stoppers to prevent over travel of curtain and bottom bar. Top 16 ½" (419.10 mm) of installation and as needed for future curtain service.
 - (1) Finish – Steel: Phosphate treatment followed by baked-on polyester powder coat, color as selected by Architect from manufacturer's standard color range, minimum 32 colors; minimum 2.5 mils (0.065 mm) cured film thickness; ASTM D-3363 pencil hardness: H or better.
 - c. Counterbalance Shaft Assembly:
 - (1) Barrel: Steel pipe capable of supporting curtain load with maximum deflection of 0.03 inches per foot (2.5 mm per meter) of width.
 - (2) Spring Balance: Oil-tempered, heat-treated steel helical torsion spring assembly designed for proper balance of door to ensure that maximum effort to operate will not exceed 25 lbs (110 N). Provide wheel for applying and adjusting spring torque.
 - d. Brackets: Fabricate from minimum 3/16 inch (5 mm) steel plate with permanently lubricated ball or roller bearings at rotating support points to support counterbalance shaft assembly and form end closures.
 - (1) Finish – Phosphate treatment followed by baked-on polyester powder coat, color as selected by Architect from manufacturer's standard color range, minimum 32 colors; minimum 2.5 mils (0.065 mm) cured film thickness; ASTM D-3363 pencil hardness: H or better.
 - e. Hood: 24 gauge galvanized steel with reinforced top and bottom edges. Provide minimum 1/4-inch (6 mm) steel intermediate support brackets as required to prevent excessive sag.
 - (1) Finish – Galvanized Steel: Phosphate treatment followed by baked-on polyester powder coat, color as selected by Architect from manufacturer's standard color range, minimum 32 colors; minimum 2.5 mils (0.065 mm) cured film thickness; ASTM D-3363 pencil hardness: H or better.
 - f. Weatherstripping:
 - (1) Bottom Bar: Replaceable, 3-point, compressible vinyl gasket extending into guides.
 - g. Operation – Manual Chain Hoist: Provide chain hoist operator with endless steel chain, chain pocket wheel and guard, geared reduction unit, and chain keeper secured to guide.
2. Electrically Operated Doors – Where doors are scheduled for electric operation, add the following:
- a. Operation
 - (1) Motor Operated: Cornell Model M26 or equivalent, UL listed, gear head, worm gear in oil bath, horsepower as recommended by manufacturer, 115v single phase service.

- Provide open drip-proof motor, removable without affecting auxiliary hand chain or setting of limit switches; auxiliary hand chain operator interlock; UL listed thermal overload protection; electric brake and rotary limit switches; transformer with 24 v control secondary; and all integral electrical components prewired to terminal blocks. Include removable electrical control panel.
- (a) Control Station: Flush mounted, "Open/Close/Stop" push buttons; NEMA 1B.
- b. Weather/Sensing Edge: Provide automatic reversing control by an automatic sensing switch within neoprene or rubber astragal extending full width of door bottom bar.
- (1) Contact with switch before fully closing shall cause door to immediately stop downward travel and reverse direction to the fully opened position.
- (2) Provide retracting safety cord and reel connection to control circuit.
- c. Wiring: All electrical wiring to be done by electrical contractor. Door Contractor to supply all materials necessary to Electrical Contractor. Low Voltage wiring by Door Contractor. See details on electrical sheets.
3. Insulated Doors – Where doors are scheduled to be insulated, add/substitute the following:
- a. Curtain:
- (1) Slats: No. 6F, 22/24 gauge ASTM A 653 (A 653M), Commercial Quality, galvanized steel with G-90 (Z 275) zinc coating, 7/8" ((22 mm) foamed-in-place, closed cell urethane insulation, total slat thickness - 15/16 inch (24 mm).
- (2) Bottom Bar: Reinforced extruded aluminum interior face with full depth insulation and exterior skin to match curtain material and gauge.
- (3) Fabricate interlocking sections with high strength nylon end locks on alternate slats each secured with two rivets. Provide wind locks as required to meet design wind load.
- (4) Slat Finish (Interior and Exterior) – Galvanized Steel: Phosphate treatment followed by baked-on polyester powder coat, color as selected by Architect from manufacturer's standard color range, minimum 32 colors; minimum 2.5 mils (0.065 mm) cured film thickness; ASTM D-3363 pencil hardness: H or better.
- (5) Bottom Bar Finish:
- (a) Exterior Face: Match slats.
- (b) Interior Face: Powder coat to match slats.
- b. Weatherstripping:
- (1) Bottom Bar, Motor Operated Doors: Weather/sensing edge within neoprene or rubber astragal extending full width of door bottom bar.
- (2) Guides: Vinyl strip sealing against fascia side of curtain.
- (3) Hood: Neoprene/rayon baffle to impede air flow above coil.
4. Locking Doors – Where doors are scheduled to be locking – Add the following:
- a. Locking: Master keyable cylinder operable from both sides of bottom bar.
5. Rated Doors – Where doors are scheduled to be Fire-Rated, add/substitute the following:
- a. Manual Operation (Where Scheduled):
- (1) Manual M100 Chain Hoist: Provide combination chain/controlled closing system operator including endless steel chain, geared reduction unit, chain keeper and a combination close operation/automatic drop test cable located at floor level.

Integral to the unit is a locking mechanism to hold the door at any position of travel during normal door operation mode and a governor to control automatic closing speed. Automatic closure shall be activated by fusible link [or a local smoke/fire detector by means of a fail-safe releasing device] [or a central smoke/fire alarm system by means of a fail-safe releasing device]. Doors shall maintain an average closing speed of not more than 9" (229 mm) per second during normal and automatic closing. Resetting of spring tension or mechanical dropouts shall not be required.

- b. Motor Operation (Where Scheduled):
 - (1) Motor Operated: M100 Series Motor Operated: Model FS, UL listed and FM approved, NEMA 1 enclosure rating, horsepower as recommended by manufacturer, 120 Volts, Single Phase at doors up to 10' x 10'; 480 Volts, Three Phase at larger doors. Provide open drip-proof motor, removable without affecting setting of limit switches; UL listed thermal overload protection; solenoid brake; planetary reduction gearing and rotary limit switches; transformer with 24 v control secondary; and all integral electrical components prewired to terminal blocks. Include removable electrical control panel. Automatic closure shall be activated by fusible link. Doors shall not require a releasing device when activated by an alarm signal. Doors shall maintain an average closing speed of not more than 9" (229 mm) per second during automatic closing. When automatic closure is activated, electric sensing edge and push button are inoperable. Doors shall be fail-safe and close upon power failure. Resetting of spring tension of mechanical dropouts shall not be required. Upon restoration of power, replacement of fusible link or clearing of the alarm signal, doors shall immediately reset by opening with the push button.
 - (2) Control Station: Flush mounted, "Open/Close/Stop" push buttons; NEMA 1B.
 - (3) Safety Features: All doors to have auto-reverse sensing edge per 7 below and photo eyes.
- c. Smoke Seal/Sensing Edge: (Motor Operated Doors) Provide automatic reversing control by an automatic sensing switch within neoprene or rubber astragal extending full width of door bottom bar.
 - (1) Contact with switch before fully closing shall cause door to immediately stop downward travel and reverse direction to the fully opened position.
 - (2) Provide retracting safety cord and reel connection to control circuit.
- d. Fusible Link with M100 FireGard™ Motor Operated System:
 - (Motor Operated Doors)
 - (1) Activation: Power outage or melting of fusible link.
 - (2) Operation: Motor operator shall close door upon signal from power outage or melting of fusible link.
 - (3) Closing Speed: Not more than 9 inches (229 mm) per second.
 - (4) Reset Procedure: Operation of control station after alarm is cleared or power is restored or replace fusible link; resetting of spring tension or mechanical dropouts shall not be required.
- e. Wiring: (Motor Operated Doors) All electrical wiring to be done by electrical contractor. Door Contractor to supply all materials necessary to Electrical Contractor. Low voltage wiring by Door Contractor. See details on electrical sheets.

2.2 Acceptable Manufacturers

- A. Manufacturers must meet or exceed specifications.
- B. Coiling Doors
 - 1. Cornell Iron Works
 - 2. Mahon Door Company
 - 3. Raynor Manufacturing Company
 - 4. The Cookson Company Inc.

PART 3 EXECUTION

3.1 Surface Conditions

- A. Inspection Prior to all Work of this Section, carefully inspect the installed work of all other trades and verify that all such work is complete to the point where this installation may properly commence.
- B. Discrepancies In the event of discrepancy, immediately notify the Owner. Do not proceed with installation in areas of discrepancy until all such discrepancies have been fully resolved.

3.2 Installation

- A. Install all special doors in strict accord with all pertinent codes and regulations, the original design, the approved Shop Drawings and the Manufacturer's current recommendations, anchoring all components firmly into position for long life under hard use.
- B. Fit, align and adjust complete door assemblies level and plumb and to provide smooth operation.
- C. Securely brace overhead door tracks suspended from structure. Secure tracks to structural members only.

3.3 Touching Up: Upon completion of the installation, touch up all scuffs and abrasions in the shop priming coat, using primer specified above.

3.4 Instructions: Upon completion of the installing, and as a condition of its acceptance, instruct the Owner's maintenance and operation personnel with the operation and maintenance of the special door and grilles.

* * * * *

THIS PAGE LEFT INTENTIONALLY LEFT BLANK

SECTION 08 41 13 ALUMINUM ENTRANCES AND STOREFRONTS

SCOPE Applicable provisions of the General and Supplementary Conditions and Division 1 govern work under this Section.

INDEX	1.1 Description	2.1 Materials
	1.2 Quality Assurance	2.2 Acceptable Manufacturers
	1.3 Submittals	2.3 Fabrication
	1.4 Product Delivery, Storage and Handling	3.1 Surface Conditions
	1.5 Warranty	3.2 Preparation
		3.3 Installation
		3.4 Adjustments and Cleaning

PART 1 GENERAL

1.1 Description

- A. Work Included: Aluminum door, window and sash, complete with finish hardware.
- B. Related Work Specified Elsewhere
 - 1. Masonry Section 04 20 00
 - 3. Metal Fabrications Section 05 50 00
 - 4. Rough Carpentry Section 06 10 00
 - 5. Caulking Section 07 92 13
 - 6. Anchors and Inserts Section 08 10 00
 - 7. Cylinders for locks Section 08 71 00
 - 8. Glazing Section 08 80 00
 - 9. Electrical Division 26
- C. Work Installed but Furnished by Others:
 - 1. Door hardware others than specified in this Section 08 71 00.

1.2 Quality Assurance

- A. Qualifications of Installers
 - 1. For actual installation of the work of this Section use only personnel who are thoroughly trained and experienced in the skills required and who are completely familiar with the Manufacturer's current recommended methods of installation as well as the requirements of this Work.
 - 2. In acceptance or rejection of installed doors and frames, no allowance will be made for lack of skill on the part of installers.
- B. Design Criteria
 - 1. System to provide for expansion and contraction within system components caused by a cycling temperature range of 170 degrees F. without causing detrimental effects to system or components.
 - 2. Design and size members to withstand dead loads and live loads caused by pressure and suction of wind as calculated in accord with the applicable building codes.
 - 3. Limit mullion deflection to 1/200 or flexure limit of glass with full recovery of glazing materials, whichever is less.

4. Drain water entering joints, condensation occurring in glazing channels or migrating moisture occurring within system, to exterior.
5. Limit air infiltration through assembly to 0.06 cubic feet per minute per square foot of assembly surface area, measured at a reference differential pressure across assembly of 0.3 inches water gage as measured in accord with ASTM E 2831.
6. System to accommodate, without damage to system or components, or deterioration of perimeter seal; Movement within system; movement between system and perimeter framing components; dynamic loading and release of loads; and deflection of structural support framing.

C. Allowable Tolerances

1. Variation from Plane: 0.03 inches per foot maximum or 0.25 inches per 30 feet, whichever is less.
2. Misalignment of Two Adjoining Members Abutting in Plane: 0.015 inches.

D. Reference Standards

1. American Society for Testing and Materials (ASTM):
 - a. A 164, Electrodeposited Coatings of Zinc on Steel
 - b. A 386, Zinc Coating (Hot-Dip) on Assembled Steel Products
 - c. B 221, Aluminum - Alloy Extruded Bars, Rods, Wire, Shapes and Tubes
 - d. E 283, Air Performance
 - e. E 330, Structural
 - f. E 331, Water
2. Aluminum Association (AA): Designation for Aluminum Finishes.
3. American Architectural Manufacturers Association (AAMA):
 - a. 501, Water
 - b. 1503, Thermal

1.3 Submittals: Within 35 days after award of Contract, and before any of the materials of this Section are delivered to the job site, submit complete to the Architect in accordance with these Specifications; the following:

- A. Samples: Submit a sample of the prefinished aluminum material illustrating the actual finish obtained in the specified anodizing.
- B. Shop Drawings: Submit complete Shop Drawings showing all details of the fabrication and installation, including system and component dimensions; components within assembly; framed opening requirements and tolerances; anchorage and fasteners; glass and infills; door hardware requirements; and adequate provision for installation of the specified glass.
- C. Certificates: Manufacturer's certificates that materials meet Specification requirements.

1.4 Product Delivery, Storage and Handling

- A. Protection: Use all means necessary to protect the materials of this Section before, during and after installation and to protect the installed work and materials of all other trades.
- B. Deliver materials in Manufacturer's packaging complete with installation instructions.
- C. Provide wrapping or strippable coating to protect prefinished aluminum surfaces.

- D. Replacements: In the event of damage, immediately make all repairs and replacements necessary to the approval of the Architect and at no additional cost to the Owner.

1.5 Warranty: Provide three year Manufacturer's warranty to cover complete system for failure to meet specified requirements.

PART 2 PRODUCTS

2.1 Materials

- A. Extruded Aluminum: ASTM B 221, 6063 alloy, T5 temper.
- B. Touch-up primer for galvanized surfaces: FS TT-P-641.
- C. Fasteners, where exposed, shall be aluminum, stainless steel or zinc plated steel in accord with ASTM A 164.
- D. Perimeter anchors shall be aluminum or steel, providing and steel is properly isolated from the aluminum.
- E. Glazing gaskets shall be EPDM elastomeric extrusions.
- F. Single acing entrance frame weatherstripping shall be a non-porous, polymeric material.
- G. Fabricated Components
 - 1. General
 - a. All assemblies for this Work, unless otherwise specifically approved by the Architect, shall be the product of one Manufacturer.
 - b. All exterior frames and doors shall be of thermal break construction. Mullion and perimeter gutters shall be separated from mullion and perimeter faces by PVC members eliminating all metal to metal contact between exterior and interior of the frame so that it will perform in such a manner that condensation will first appear on the glass before the metal.
 - 2. Exterior Framing System: 4-1/2 inch deep by 2 wide profile of Kawneer TRI-FAB-VG-451-T; extruded aluminum alloy, ASTM B 221; thermally broken with interior portion of frame section completely insulated; complete with extruded aluminum security type snap-in glass stops for sidelights and transom lights, of profile to suit frame section. Verticals to be SSG Type Exterior Butt-Glazed.
 - 3. Interior Frames: 4-1/2 inch deep by 1-3/4 inch wide profile Kawneer Tri-Fab II 451; of extruded aluminum alloy; ASTM B 221 complete with extruded aluminum security type snap-in glass stops for sidelights and transom lights, of profile to suit frame section.
 - 4. Curtain Wall Frames: 7 1/2 inch total deep by 2 1/2 inch wide profile Kawneer 1600 series with extruded aluminum security type snap-in glass stops for sidelights and transom lights, of profile to suit frame section. Size for required wind loading.
 - 5. Doors: Of extruded aluminum alloy; ASTM B 221; wide stile, Kawneer 500, 1-3/4 inches thick with 5 inch wide vertical stiles, 5 inch wide top rail and 6 1/2 inch wide bottom rail; for 1 inch exterior glass and 1/4 inch thick interior glass secured with snap-in glazing splines.
 - 6. Door, Sidelight and Transom Light Glass: Exterior and Interior located; thickness and type same as doors as called for in these Specifications.

H. Finish

1. All exposed framing surfaces shall be free of scratches and other serious blemishes. Aluminum moldings shall be given a caustic etch followed by an anodic oxide treatment to obtain;
 - a. Anodized Finish Permanodic coating conforming to Aluminum Association Standard AA-M12 C22 A44, Bronze.
2. Concealed Steel Items: Galvanized in accord with ASTM A 386 to 2 ounces per square foot.
3. Apply one coat of bituminous paint to concealed aluminum and steel surfaces in contact with cementitious or dissimilar materials.

I. Hardware

1. Weatherstripping, sweep strips, thresholds, hinges: Manufacturer's recommended standard type.
2. Hinges: Full length piano, heavy duty.
3. Push/Pulls: Designer style 1" offset tube each face, 12" long.
4. Panic Device: Panic device per Section 08 71 00 to be provided by Aluminum Entrance Contractor per hardware schedule for aluminum entrance doors.
5. Closer: Heavy-Duty type.
6. Cylinder Lock: 5 pin mortised
7. Security strike as shown as security on hardware schedule; wiring by Electronic Systems Contractor.
8. Prepare doors to meet requirements of electronic systems swipe card entry security systems.
9. Push bottom door opener by Aluminum Door Contractor per Section 08 71 00 2.1 P

- J. Other Materials: All other materials, not specifically described but required for a complete and proper installation shall be new, first quality of their respective kinds and subject to approval of the Architect.

2.2 Acceptable Manufacturers:

- A. Kawneer
- B. U. S. Aluminum
- C. EFCO
- D. CMI Architectural Products
- E. Tubelite

2.3 Fabrication

- A. Fabricate aluminum doors and frames to allow for clearances and shim spacing around perimeter of assemblies to enable installation.
- B. Fabricate aluminum sills, head jamb, jamb closures at exposed precast, insulation as all doors and sash terminations, caps at extended sills, etc, as shown on Drawings.

- C. Provide anchorage devices to securely and rigidly fit door and frame assemblies in place.
- D. Accurately and rigidly fit together joints and corners. Match components ensuring continuity of line and design. Ensure joints and connections are flush, hairline and weatherproof.
- E. Provide for moisture entering joints and condensation occurring within frame construction to drain to exterior.
- F. Make provision for hardware and provide required internal reinforcing.
- G. Shop prefabricate all doors and frames into complete units.
- H. Fabricate in strict accord with the approved Shop Drawings and the Manufacturer's published recommendations.
- I. Weld or mechanically fasten along entire line of contact on the unexposed side.
- J. No discoloration of the face after anodizing will be acceptable.

PART 3 EXECUTION

3.1 Surface Conditions

- A. Inspection
 1. Prior to all Work of this Section, carefully inspect the installed work of all other trades and verify that all such work is complete to the point where this installation may properly commence.
 2. Verify that doors and frames may be installed in complete accord with the original design and the approved Shop Drawings.
 3. Assure that frame openings correspond to dimensions of frame furnished.
 4. Beginning of installation means acceptance of existing conditions.
- B. Discrepancies
 1. In the event of discrepancy, immediately notify the Architect.
 2. Do not proceed with installation in areas of discrepancy until all such discrepancies have been fully resolved.

3.2 Preparation

- A. Verify all measurements at the job site prior to fabrication.

3.3 Installation

- A. Install aluminum doors and frames in accord with Manufacturer's recommendations. Ensure assemblies are plumb, level and free of warp or twist. Maintain dimensional tolerances and alignment with adjacent work.
- B. Use sufficient anchorage devices to securely and rigidly fasten door and frame assemblies to the building.

- C. Install all members with adequate provision for settling, expanding and contracting to occur without breaking glass.
- D. Install hardware in accord with Manufacturer's recommendations, using proper templates. Adjust operating hardware.
- E. Install batt insulation in shim spaces around perimeter of door and frame assemblies, to maintain continuity of thermal barrier.
- F. Install perimeter sealant and related backing materials in accord with workmanship and installation requirements indicated in Section 07 92 00.

3.4 Adjustment and Cleaning

- A. Remove protective material from prefinished aluminum surfaces.
- B. Remove dirt from exposed surfaces using a solution of mild detergent in warm water, applied with soft, clean wiping cloths. Take care to remove dirt from corners. Wipe surfaces clean.
- C. Remove excess sealants or glazing compounds from exposed surfaces by moderate use of mineral spirits or other solvent acceptable to sealant Manufacturer.
- D. Touch up marred or abraded surfaces to match original finish.
- E. Adjust moving parts for smooth operation.
- F. Remove debris from project site.

* * * * *

SECTION 08 71 00 HARDWARE

SCOPE Applicable provisions of the General and Supplementary Conditions and Division 1 govern work under this Section.

INDEX	1.1 Description	2.2 Acceptable Manufacturers
	1.2 Quality Assurance	3.1 Deliveries
	1.3 Submittals	3.2 Installation
	1.4 Product Delivery, Storage and Handling	3.3 Inspection of Installation
	2.1 Materials	3.4 Setup & Training

PART 1 GENERAL

1.1 Description

- A. Work Included: The required hardware for doors is indicated on the Drawings in the form of a hardware schedule; in addition provide hardware for all cabinetwork.
- B. Related Work Specified Elsewhere
 - 1. Architectural woodwork Section 06 40 00
 - 2. Installation on metal doors and frames Section 08 11 00
 - 3. Aluminum Entrances and Storefronts Section 08 41 13

1.2 Quality Assurance

- A. Qualification of Supplier: The finish hardware supplier will employ a hardware consultant who will prepare all submittals and be available to the Owner for consultation should any problems arise during the course of the work; this consultation will be at no additional cost to the Owner. The hardware consultant shall check all installations and report to the Architect.
- B. Quality of Hardware: All hardware will meet applicable materials and finishes standards of the Builders' Hardware Manufacturer's Assn., ANSI A156, and Underwriters' Laboratory for all hardware in fire rated assemblies.
- C. Reference Standards
 - 1. American National Standards Institute (ANSI):
 - a. A115.1 - Door and Frame Preparation for Mortise Door Locks for 1-3/4 inch Doors.
 - b. A115.2 - Door and Frame Preparation for Bored or Cylindrical Locks for 1-3/4 inch Doors.
 - c. A115.4 - Door and Frame Preparation for Lever Extension Flush Bolts.
 - d. A115.5 - Frame Preparation for 181 & 190 Series Deadlock Strikes.
 - e. A115.9 - Door and Frame Preparation for Closer, Offset Hung, Single Acting.
 - f. A115.13 - Door and Frame Preparation for Tubular Deadlocks.
 - g. A115.14 - Preparation for Standard Steel Doors for Open Back Strikes.
 - h. A156.1 - Butts and Hinges.
 - i. A117.1 Accessible and Usable Buildings and Facilities.
 - j. A156.2 - Locks and Lock Trim.
 - k. A156.3 - Exit Devices.
 - l. A156.4 - Door Controls (Closers).
 - m. A156.6 - Architectural Door Trim.

- n. A156.7 - Template Hinges.
- o. A156.8 - Door Controls (Overhead Holders).

1.3 Submittals: Within 35 days after award of Contract, and before any of the materials of this Section are delivered to the job site, submit complete to the Architect in accordance with these Specifications; the following:

- A. Samples
 - 1. Submit samples of each type of hardware required for job.
 - 2. Indicate required style and finish.
- B. Shop Drawings and Product Data
 - 1. Submit Shop Drawings and product data for each style of hardware.
 - 2. Indicate locations and mounting heights of each type of hardware.
 - 3. Supply templates to door and frame manufacturers to enable proper and accurate sizing and locations of cutouts for hardware.
- C. Material List: Before any finish hardware is ordered for this work, submit to the Architect, for approval, a complete list of all finish hardware proposed to be furnished, giving Manufacturer's name, catalog number with a picture of each item.
- D. Operation and Maintenance Data: Provide Architect with Manufacturer's parts list and maintenance instructions for each type of hardware supplied and necessary wrenches and tools required for proper maintenance of hardware.

1.4 Product Delivery, Storage and Handling

- A. Protection: Use all means necessary to protect the materials of this Section before, during and after installation and to protect the installed work and materials of all other trades.
- B. Packaging
 - 1. Furnish all finish hardware with each unit clearly marked or numbered in accord with the Hardware Schedule.
 - 2. Pack each item complete with all necessary pieces and fasteners.
 - 3. Properly wrap and cushion each item to prevent scratches during delivery and storage.
- C. Delivery: Deliver all finish hardware to the installers in a timely manner to ensure orderly progress of the total work.
- D. Replacements: In the event of damage, immediately make all repairs and replacements necessary to the approval of the Architect and at no additional cost to the Owner.

PART 2 PRODUCTS

2.1 Materials: All Hardware Finish is to be US10B (#613) – Oil Rubbed Bronze on all hardware except locksets. Lockset finish to be #643e – Aged Bronze.

- A. General
 - 1. Provide items as listed in this Section, complete to function as intended.
 - 2. Furnish all finish hardware with all necessary screws, bolts and other fasteners of suitable size and type to anchor the hardware in position securely.
 - 3. Furnish fastenings where necessary with expansion shields, toggle bolts, hex bolts and other anchors approved by the Architect, according to the material to which the hardware is to be applied and the recommendations of the hardware manufacturer.
 - 4. Design: All fastenings shall harmonize with the hardware as to material and finish.
 - 5. Fire label approved hardware to be used on all fire rated doors.

- B. Hinges: 5 knuckle, button tip, full mortise, template type, butts with non-rising loose pins. See schedule for ball bearings. Finish 4-1/2 X 4-1/2.

- C. Closures: Furnish flat rectangular type closures with covers. Size all closers in accord with the Manufacturer's recommendations and good standard practice. All surface mounted closures shall be the product of a single manufacturer. Hold opens and door stops where scheduled.

- D. Door Holders: Surface mounted or integral with door closure where applicable.

- E. Panic Hardware: Cylinder bolts and latches per schedule. Panic hardware at aluminum doors by aluminum door contractor.
 - 1. For single doors scheduled as "Panic – NL", supply door pull as specified below and panic hardware with night latch function. Von Duprin – #99NL-OP type, fire hardware where scheduled, finish to be 313AN Dark Bronze.
 - 2. For double doors scheduled as "Panic – NL", supply door pull as specified below and panic hardware with night latch function. Surface mounted vertical rod. Von Duprin – #9927NL-OP type, fire hardware where scheduled, finish to be 313AN Dark Bronze.
 - 3. For single doors scheduled as "Panic – L", supply integral panic hardware and lever. Von Duprin -- #99L-06 type, fire hardware where scheduled, finish to be 313AN Dark Bronze.
 - 4. For double doors scheduled as "Panic – L", supply integral panic hardware and lever. Surface mounted vertical rod. Von Duprin -- #9927L-06 type, fire hardware where scheduled, finish to be 313AN Dark Bronze.

- F. Door stops:
 - 1. Wall mounted, rubber tipped, mount level with knob. 1" projection.
 - 2. Floor mounted: cast dome type, rubber cushion.
 - 3. Door mounted: Rubber tipped, 3-3/4" projection, mount where shown.
 - 4. Integral with closer where scheduled.

- G. Push-pull: Designer style 1" offset tube - Rockwood #107X70B with Rockwood #70B push plate.

- H. Kick-plates: Colored plastic to match Hardware.

- I. Lockset
 - 1. Best Locks: 9K Series, or equal function as scheduled, lever style 15, Rose style D, finish to be bronze.

- 2. Schlage Locks: ND Series, function as scheduled, lever style "Rhodes", finish to be bronze.
- J. Soundstop: Tear drop shape, Zero #188N or equal.
- K. Door sweeps: On schedule listed as door sweep type, Hager #747S to isolate sound from vehicle areas.
- L. Weatherstrip: Zero 626 aluminum to sizes, color and profiles to fit door application and hardware color.
- M. Name Plates: ABS plastic with raised lettering. White letters; background color - selected from standard palette and symbols. ADA approved signs at toilet rooms. See drawings for details.
- N. Threshold: Saddle type, aluminum 6063-T5 mill finish, aluminum color, size 4" X 1/2".
- O. Keying
 - 1. All cylinders shall be construction masterkeyed. No substitutions will be allowed.
 - 2. Master key all locks in accord with Owner's Master Key system.
 - 3. Perform all keying at the factory. Have construction Master Keys only delivered to the job site. Send all other keys, tagged and identified directly to the Owner by registered mail. Stamp all permanent keys and key blanks: "Do Not Duplicate".
 - 4. Deliver two keys for each type of lock plus two master keys.
- P. Electric strikes: H.E.S. 1003 Series, compatible with scheduled frames.
- Q. Automatic door operators and entry and exit radio controlled push plates.
 - 1. Stanley Magic Access operators including headers, control boxes and arms or equal, One (1) each per doors #1 and #2.
 - 2. 24V Radio receivers or equal; One (1) each per doors #1 and #2.
 - 3. 4 -1/2" Radio controlled push plates; Two (2) each per doors #1 and #2.
 - 4. Color – Dark Bronze

2.2 Acceptable Manufacturers

- | | |
|-----------------|--|
| A. Exit Devices | Russwin, Von Duprin |
| B. Push-Pull | Brookline, Dor-Line, Russwin, Hiawatha, Rockwood |
| C. Cylinder | Schlage, Corbin |
| D. Closer | LCN, Norton |
| E. Wall Stop | Ives, Corbin Russwin |
| F. Threshold | Brookline, Reese, Zero |
| G. Hinges | Hager |
| H. Weatherstrip | Zero, Gossen |
| I. Kickplates | Brookline |
| J. Locksets | Best Access Systems, Schlage |
| K. Door Holders | Glynn-Johnson, Russwin |
| L. Soundstops | National Guard Products, Zero |
| M. Door Sweeps | National Guard Products, Zero |

PART 3 EXECUTION

3.1 Deliveries: Stockpile all items sufficiently in advance to ensure their availability and make all necessary deliveries in a timely manner to ensure orderly progress of the total work.

3.2 Installation

- A. Install all hardware securely in place, test, oil, grease, adjust for perfect operation.
- B. Maintain following mounting heights for doors, from finished floor to center line of hardware item: Conform to applicable codes for accessibility requirements.
 - 1. Hinges
 - a. Top - 5 inches from head of frame to top of hinge.
 - b. Bottom - 10 inches from finished floor to bottom of hinge.
 - c. Intermediate - centered between top and bottom hinges.
 - d. On Dutch doors - 5 inches from head of frame to top of hinge; 10 inches from finished floor to bottom of bottom hinge. 5 inches from split line to top and bottom respectively of lower and upper intermediate hinges.
 - 2. Unit and integral type locks and latches - 38 inches to centerline of knob.
 - 3. Deadlocks - 48 inches to centerline of cylinder.
 - 4. Panic hardware - 38 inches to centerline of cross bar.
 - 5. Door pulls - 42 inches to center of grip.
 - 6. Push-pull bars - 42 inches to centerline of bar.
 - 7. Arm pulls - 47 inches to centerline.
 - 8. Push plates - 48 inches to centerline of plate.
 - 9. Roller latches - 45 inches to centerline.
 - 10. Nameplates - 60 inches to centerline, on wall adjacent to latch side of door.

3.3 Inspection of Installation: Upon completion of the installation, and as a condition of its acceptance, deliver to the Architect a report signed by the hardware consultant stating that the consultant's inspection was made, that all adjustments recommended have been complete, and that all finish hardware furnished under this Section has been installed and is in optimum working condition.

3.4 Setup and Training: Upon completion of the installation of the electronic access hardware, install software and card encoder on site. Provide on site training and one-year of telephone support.

* * * * *

THIS PAGE LEFT INTENTIONALLY BLANK

SECTION 08 80 00 GLAZING

SCOPE Applicable provisions of the General and Supplementary Conditions and Division 1 govern work under this Section.

INDEX	1.1 Description	2.2 Acceptable Manufacturers
	1.2 Quality Assurance	2.3 Fabrication
	1.3 Submittals	3.1 Surface Conditions
	1.4 Product Delivery, Storage and Handling	3.2 Preparation
	1.5 Job Conditions	3.3 Installation
	1.6 Warranty	3.4 Protection of Completed Work
	2.1 Materials	3.5 Cleaning

PART 1 GENERAL

1.1 Description

- A. Work Included: Glass and glazing required for this Work includes tempered and regular plate glass; insulating glass; wire glass and safety glass; and bronze tint insulating glass; glass mirrors; glass doors; and glass sound seal.
- B. Related Work Specified Elsewhere
 - 1. Joint sealers Section 07 92 13
 - 2. Metal doors and frames Section 08 11 00
 - 3. Aluminum entrances and storefronts Section 08 41 13

1.2 Quality Assurance

- A. Qualifications of Manufacturers
- B. Qualifications of Installers: Provide at least one person who shall be thoroughly trained and experienced in the skills required, who shall be completely familiar with the referenced standards and the requirements of this Work, and who shall personally direct all installation performed under this Section of these specifications.
- C. Requirements of Regulatory Agencies: Install glass and glazing to meet requirements of State and Federal Building Codes.
- D. Source Quality Control
- E. Reference Standards
 - 1. American National Standards Institute (ANSI):
 - a. Z 97.1, Safety Performance Specifications and Methods of Test for Safety Glazing Material Used in Buildings
 - 2. American Society for Testing and Materials (ASTM):
 - a. E 84, Surface Burning Characteristics of Building Materials.
 - 3. Federal Specifications (FS):
 - a. DD-G-451, Glass, Float or Plate, Sheet, Figured (Flat, for Glazing, Mirrors and Other Uses).

- b. DD-G- 1403, Glass, Plate (Float), Sheet, Figured, and Spandrel (Heat Strengthened and Fully Tempered).
- c. TT-S-230, Sealing Compound: Synthetic Rubber Base, Single Component, Chemically Curing for Caulking, Sealing and Glazing in Building Construction.
- d. TT-S-1543, Sealing Compound: Silicone Rubber Base (for Caulking, Sealing and Glazing in Buildings and Other Structures).
- 4. Conform to Flat Glass Marketing Association (FGMA) Glazing Manual and Glazing Sealing Systems Manual for glazing installation methods.
- 5. Sealed Insulating Glass Manufacturers Association (SIGMA):
 - a. 64-7-2, Specification for Sealed Insulating Glass Units.

1.3 Submittals: Within 35 days after award of Contract, and before any of the materials of this Section are delivered to the job site, submit complete to the Owner in accordance with these Specifications; the following:

- A. Shop Drawings: Sections and details of glass installation at framing members such as head, mullions, transoms, jambs and sills. Provide schedule of sizes, quantities, locations and mounting methods.
- B. Manufacturer's Literature
 - 1. Manufacturer's descriptive data of glass materials. Provide structural, physical and environmental characteristics, size limitations, and special handling or installation requirements.
 - 2. Provide data on glazing sealant identifying available colors.

1.4 Product Delivery, Storage and Handling

- A. Protection
 - 1. Use all means necessary to protect the materials of this section before, during and after installation and to protect the installed work and materials of all other trades.
 - 2. Keep glass free from contamination by materials capable of staining glass.
- B. Delivery of Materials
 - 1. Deliver glass with Manufacturer's labels intact. Do not remove labels until glass has been installed.
 - 2. Deliver glazing compounds and sealants in Manufacturer's unopened, labeled containers.
- C. Replacements: In the event of damage, immediately make all repairs and replacements necessary to the approval of the Owner and at no additional cost to the Owner.

1.5 Job Conditions

- A. Environmental Requirements
 - 1. Perform glazing when ambient temperature is above 40 degrees F.
 - 2. Perform glazing on dry surfaces only.

1.6 Warranty

1. The subcontract for the glass will not be approved by the Owner until the subcontractor has submitted to the Owner, for approval, the proposed warranty on the glass material to be supplied. This warranty should be supplied to the Owner on execution of the General Contract. This warranty should cover a period of 5 years.
2. Include coverage of sealed glass units from seal failure, interpane dusting or misting and replacement of same.
3. Mirror warranty to cover glass and coating against discoloration or manufacturing defects and against failure from mastic.

PART 2 PRODUCTS

2.1 Materials

A. Glass

1. Float Glass: FS DD-G-451; Type I, Class 1, quality; 1/4" and 3/8" inch thick.
2. Safety Glass: FS DD-G-451 and FS DD-G-1403; Type I; All floor to ceiling glass to be 3/8 inch tempered clear or bronze tint per elevations, all other interior glass walls to be 1/4" tempered clear or tint per elevations.
3. Safety Glass: FS DD-G-1403; Kind HS, Condition A. Type I, 1/4 inch thick minimum clear.
4. Tinted Glass: Float and safety glass - Bronze tint heat absorbing: FS DD-G-451 and FS dd-G-1403 Style A. Type I, Class 2 - 1/4" inch thickness.
5. Insulated Glass Units: Double pane units with edge seal; outer pane 1/4 inch Bronze tint, inner pane 1/4" clear, 1/2 inch interpane space purged with inert argon gas. Total unit thickness 1 inch. Low emissivity, #3 surface. Tempered pane each face where required by 1.2.C or if shown on Drawings or specified in addition to above code reference.
Insulating glass to meet the following requirements:
 - a. Transmittance: average daylight -44%; solar -35%; UV – 23%
 - b. External reflectance: average daylight -8%; solar – 7%.
 - c. Winter U-Value – 0.30
 - d. Shading coefficient – 0.53
 - e. Relative heat gain - 111
6. Exterior and interior glass edge finished for silicone butt glazing.
 - a. Silicone Sealant: FS-S-1543, Type II, Class A, single component neutral cure medium modulus silicone for butt glazing, color as selected by Owner.
 - b. Urethane Sealant: FS S-230-6, Type II, Class A, single component polymer for general glazing, color as selected by Owner.
7. Spandrel Glass: Ceramic frit type to match tinted glass.
8. Fire Rated Glass: Fire-protection-rated glazing suitable for use in a rated door assembly as scheduled. SuperLite I-XL by Safti First, 60 minute rated, or equal.

B. Glazing Accessories

1. Setting Blocks: Neoprene; 70-90 Shore A durometer hardness; 4 inches long by 3/8 inch wide by 1/4 inch high, chemically compatible with sealant used.
2. Spacer Shims: Neoprene; 50 Shore A durometer hardness; 3 inches long by 1/4 inch wide by 1/4 inch thick; self adhesive one face, chemically compatible with sealant used.

3. Glazing Tape: Preformed butyl compound; 10-15 Shore A durometer hardness; coiled on release paper; Size and spacers where recommended by manufacturer; black color.
4. Glazing Splines: Resilient polyvinylchloride extruded shape to suit glazing channel retaining slot; color as selected.
5. Glazing Clips: Manufacturer's standard type.
6. Filler Rod: Compressible synthetic rubber of foam, chemically compatible with sealant use.
7. Primer-Sealers and Cleaners: As recommended by glass Manufacturer.

2.2 Acceptable Manufacturers

- A. Glass: SIGMA Member
- B. Glazing Compound: Tremco
 1. Butt glazing: Silicone sealant: Spectrum 2
 2. Standard glazing: Dymonic
- C. Substitutions: Under provisions of Section 01 60 00.
- D. Wausau Window and Wall System

2.3 Fabrication

- A. Glass: All glass shall bear labels showing strength, thickness, type and quality and shall be relatively distortion free with all distortion waves in the horizontal direction and shall be in the following qualities.
- B. Interior Glazing: Door lites all tempered; 1/4 inch clear, tint, or frosted per door schedule: fixed lites 1/4 inch clear or tint plate tempered below eye level; 3/8 inch and 1/4 inch clear or tint plate, edges for butt glazing.
 1. Tinting Schedule
 - a. Provide Clear Glass at all interior glass
 - b. Provide Bronze tinted glass at all interior glass
- C. Exterior Glazing
 1. Windows: One inch Bronze tint insulating.
 2. Doors and sidelites: One inch insulating tempered.
 3. Edges for butt glazing.
- D. Tempered Glass: Where tempered insulating glass is called for, both lites will be tempered.
- E. Insulating Glass: Exterior insulating glass construction shall be; 1/4 inch Bronze exterior, 1/2 inch air space and 1/4 inch clear interior lite. Low emensivity #3 surface, inert argon gas, tempered where specified or required. Edges for butt glazing at all windows with two panes.

PART 3 EXECUTION

3.1 Surface Conditions

A. Inspection

1. Prior to all Work of this Section, carefully inspect the installed work of all other trades and verify that all such work is complete to the point where this installation may properly commence.
2. Verify that all glazing may be performed in accord with all pertinent codes and regulations, the original design and the reference standards.
3. Check that glazing channels are free of burrs, irregularities and debris.
4. Check that glass is free of edge damage or face imperfections.
5. Do not proceed with installation until conditions are satisfactory.
6. Beginning of installation means acceptance of substrate.

B. Discrepancies

1. In the event of discrepancy, immediately notify the Owner.
2. Do not proceed with installation in areas of discrepancy until all such discrepancies have been fully resolved.

3.2 Preparation

A. Field Measurements

1. Measure size of frames to receive glass.
2. Compute actual glass size, allowing for edge clearances.

B. Preparation of Surfaces

1. Remove protective coatings from surfaces to be glazed.
2. Clean glass and glazing surfaces, to remove dust, oil and contaminants and wipe dry.
3. Seal porous glazing channels or recesses.
4. Prime surfaces scheduled to receive sealant.

3.3 Installation - Application - Erection

A. General

1. Positioning Glass
 - a. Orient pattern and draw of glass pieces in same direction.
 - b. Place glass waves parallel to floor.
 - c. Set smooth side to exterior.
2. Do not cut, seam, nip or abrade tempered, heat strengthened, coated or insulating glass.
3. Slope exterior surfaces of gaskets, tapes and sealant beads to provide for water runoff.
4. All glazing materials must be compatible.
5. Provide weep holes to remove all water from the glazing assembly.

B. Exterior Dry Method (Preformed Glazing)

1. Cut glazing tape spline to length; install on glass pane. Seal corners by butting tape and dabbing with butyl sealant.
2. Place setting blocks at 1/4 points.

3. Rest glass on setting blocks and push against fixed stop with sufficient pressure to attain full contact at perimeter of pane.
4. Install removable stops without displacement of glazing spline. Exert pressure for full continuous contact.
5. Trim protruding tape edge.

C. Interior Dry Method (Tape and Tape)

1. Cut glazing tape to length and set against permanent stops, projecting 1/16 inch above sightline.
2. Place setting blocks at 1/4 1/3 points.
3. Rest glass on setting blocks and push against tape for full contact at perimeter of pane.
4. Place glazing tape on free perimeter of pane in same manner described above.
5. Install removable stop without displacement of tape. Exert pressure on tape for full continuous contact.
6. Knife trim protruding tape.

3.4 Protection of Completed Work

- A. Attach crossed streamers away from glass face.
- B. Do not apply markers to glass surface.
- C. Replace damaged glass.

3.5 Cleaning

- A. Remove excess glazing compound from installed glass and frames.
- B. Remove labels from glass surface as soon as installed.
- C. Wash and polish faces of glass.
- D. Remove debris from worksite.

* * * * *

SECTION 09 91 00 PAINTING

SCOPE Applicable provisions of the General and Supplementary Conditions and Division 1 govern work under this Section.

INDEX	1.1 Description	2.3 Mixing and Tinting
	1.2 Quality Assurance	3.1 Surface Conditions
	1.3 Submittals	3.2 Preparation of Surfaces
	1.4 Product Delivery, Storage and Handling	3.3 Paint Application
	1.5 Job Conditions	3.4 Reinstallation of Removed Items
	2.1 Materials	3.5 Cleaning Items
2.2 Acceptable Manufacturers	3.6 Painting Schedules	

PART 1 GENERAL

1.1 Description

A. Work Included

1. The Painting Contractor shall furnish all material, labor and equipment required to complete all painting and finishing as shown on the Drawings, Plans and Specifications.
2. The Painting Contractor shall examine the Specifications for the various other trades and shall thoroughly become familiar with all provisions regarding painting. All surfaces that are left unfinished by the requirements of other Specifications shall be painted or finished as a part of this Work.
3. In general, paint all wood, metal surfaces, doors, frames, masonry; omit acoustic tile, aluminum and prefinished wood doors.
4. Following Specifications cover complete painting, finishing of wood and other surfaces throughout interior and exterior of building, unless otherwise noted.
5. Painting Contractor will include in his Bid the Painting of all cabinetwork and millwork supplies as part of the Millwork Contractor's Bid.
6. The types of paint to be used and the number of coats to be applied are listed in the Painting Schedule in Part 3.7 of this Section of these Specifications.
7. Furnish tools, ladders, scaffolding, and other equipment necessary for work completion.

B. Related Work Specified Elsewhere

1. Prefinishing: Shop priming and factory prefinishing are required on some, but not all of the items described in other Sections of these Specifications.
2. Structural Steel, Miscellaneous Metals and Metal Doors and Frames; one shop coat and touching up in field.
3. Sealants and Caulking Section 07 92 13
4. Gypsum Board System Section 09 29 00
5. Painting of Exterior Roof Vents/Louvers Division 23

C. Definitions

1. The term "Paint", as used herein, includes enamels, paints, sealers, fillers, emulsions, and other coatings, whether used as prime, intermediate or finish coats.

2. "Coats" described later are based on roller, brush or spray application. Above does not refer to processes that require spraying only for their application or where specifically specified to be sprayed.
3. Conform to ASTM D16 for interpretation of terms used in this Section.

1.2 Quality Assurance

A. Qualifications of Painters

1. Maintain a crew of painters throughout the duration of the work who shall be qualified to fully satisfy the requirements of this Specification.
2. Use only qualified journeyman painters for the mixing and application of paint on exposed surfaces. Apprentices may be employed to work under the direction of qualified journeymen, in accord with trade regulations. In the acceptance or rejection of installed painting, no allowance will be made for lack of skill on the part of painters.

B. Requirements of Regulatory Agencies

1. Occupational Safety and Health and pollution Regulations: Conform to the Federal and State requirements for painting work applicable to this Project.
2. Permits: Obtain and pay for any special permits required by local governmental agencies.

C. Reference Standards

1. American Society for Testing and Materials (ASTM):
 - a. D 16, Definitions of Terms Relating to Painting, Varnish, Lacquer and Related Products.
2. In addition to complying with all pertinent codes and regulations, comply with "Standard (Type 1)" as defined by the Painting and Decorating Contractors of America in their "Modern Guide to Paint Specifications", current Edition.

1.3 Submittals: Within 35 days after award of Contract, and before any of the materials of this Section are delivered to the job site, submit complete to the Owner in accordance with these Specifications; the following:

- A. Samples: Accompanying the materials list, submit to the Owner two copies of the full range of colors, textures and finishes available in each of the proposed products.
- B. Manufacturer's Recommendations: In each case where material proposed is not the material specified or specifically described as an acceptable alternate in this Section of these Specifications, submit for the Owner's review the current Manufacturer of the proposed material.
- C. Material List
 1. A complete list of all materials proposed to be furnished and installed under this portion of the Work.
 2. This shall in no way be construed as permitting substitution of materials for those specified or approved for this Work by the Owner.
- D. Color Charts: Include color charts for selection by Owner.

- E. Extra Stock: Upon completion of this portion of the Work, deliver to the Owner an extra stock of paint equaling approximately 10% of each color used in each coating material used, with all such extra stock tightly sealed in clearly labeled containers. Extra stock to be from batch mix furnished for Work.

1.4 Product Delivery, Storage and Handling

- A. Protection: Use all means necessary to protect the materials of this Section before, during and after installation and to protect the installed work and materials of all other trades.
- B. Delivery of Materials: Deliver all paint materials to the job site in their original unopened containers with all labels intact and legible at time of use.
- C. Storage of Materials
 - 1. Store only the approved materials at the job site, and store only in suitable and designated area restricted to the storage of paint materials and related equipment.
 - 2. Use all means necessary to ensure the safe storage and use of paint materials and the prompt and safe disposal of waste.
 - 3. Store paint materials at minimum ambient temperature of 45 degrees F. and a maximum of 90 degrees F., in well ventilated area, unless required otherwise by Manufacturer's instructions.
- D. Handling Materials and Equipment
 - 1. Take precautionary measures to prevent fire hazards and spontaneous combustion.
 - 2. All soiled or used rags, waste and trash must be removed from the building each night and every precaution taken to avoid the danger of fire.
 - 3. Toxic Materials:
 - a. Where toxic materials, including both toxic and explosive solvents are used, take appropriate precautions as a regular procedure, conforming to the Manufacturer's recommendations and to the requirements of the applicable safety regulatory agencies.
 - b. In applying acid etch coating or solutions and toxic materials, provide ventilation and take protective measures to conform to the requirements of regulatory agencies.
- E. Replacements: The painting trade is responsible for making repairs of their own Work when due to defective workmanship or materials. Repair of damaged paint finish caused by other trades will be done by this Contractor but paid for by the contractor causing such damage. See Section 01 70 00.

1.5 Job Conditions

- A. Environmental Requirements
 - 1. Comply with Manufacturer's recommendations as to environmental conditions under which coatings and coating systems can be applied.
 - 2. Do not apply finish in areas where dust is being generated.

3. Provide continuous ventilation and heating facilities to maintain surface and ambient temperatures above 45 degrees F. for 24 hours before, during and for 48 hours after application of finishes, unless required otherwise by Manufacturer's instructions.
4. Do not apply exterior coatings during rain or snow or when relative humidity is above 50 percent, unless required otherwise by Manufacturer's instructions.
5. Minimum Application Temperatures for Latex Paints: 45 degrees F. for interiors; 50 degrees F. for exteriors; unless required otherwise by Manufacturer's instructions.
6. Minimum Application Temperature for Varnish Finishes: 65 degrees F. for interior, unless required otherwise by Manufacturer's instructions.
7. Provide lighting level of 80 foot candles measured mid-height at substrate surface.
8. Do not do exterior work on unprotected surfaces if it is raining or moisture from any other source is present or expected before applied materials can dry or attain proper cure.
9. Allow surfaces wetted by rain or other moisture source to dry and to attain temperatures and conditions specified before proceeding or continuing with coating application.

B. Protection

1. Cover or otherwise protect finished work of other trades and surfaces not being painted concurrently or not to be painted.
2. The Painting Contractor shall protect surfaces and objects inside and outside the building, as well as the grounds, lawns, shrubbery and adjacent properties against damage. The Painting Contractor shall be held responsible for damage to adjacent furnishings.
3. Drop Cloths: Provide sufficient drop cloths, shields and protective equipment to prevent spray or drippings from fouling surfaces not being painted including surfaces within the paint storage and preparation areas.
4. Exposed Concrete Floors: Floor slabs that will not be covered by other finishes will be protected against staining or damage by the work of the Painting Contractor. Repair of such damage may include replacement of the slab if so determined by the Architect or Owner.

PART 2 PRODUCTS

2.1 Materials

- A. Select primary products of the coating system from products of a single manufacturer.
- B. Secondary products not specified by name and required for the job such as oils, thinners, patching, compounds, putty, shall be "best grade" or "first line" products of a reputable manufacturer.
- C. Compatibility
 1. All paint materials and equipment shall be compatible in use; finish coats shall be compatible with prime coats; prime coats shall be compatible with the surface to be coated; all tools and equipment shall be compatible with the coating to be applied.
 2. Thinners, when used, shall be only those thinners recommended for that purpose by the Manufacturer of the material to be thinned.
 3. All shop primers are required to be approved by finish coat paint manufacturer.

- D. Colors and glosses: All colors shall be as selected by the Owner and will be limited to not more than six paint colors in the total Work.
1. Colors of paints and stains match color chips submitted to the Owner.

2.2 Acceptable Manufacturers

- A. Materials selected for coating systems for each type surface shall be the product of a single manufacturer.

2.3 Mixing and Tinting

- A. Deliver paints and enamels ready-mixed to job site.
- B. Accomplish job mixing and job tinting only when acceptable to the Owner.
- C. Fungicidal agent shall be incorporated into the paint by the Manufacturer.

PART 3 EXECUTION

3.1 Surface Conditions

- A. Inspection
1. Prior to all Work of this Section, carefully inspect the installed work of all other trades and verify that all such work is complete to the point where this installation may properly commence.
 2. Verify that paint finishes may be applied in strict accord with all pertinent codes and regulations and the requirements of these Specifications.
 3. Examine surfaces scheduled to receive paint and finishes for conditions that will adversely affect execution, permanence or quality of work and which cannot be put into an acceptable condition through preparatory work as included in Article 3.2 Preparation.
 4. If woodwork, metal or any other surface to be finished cannot be put in proper condition for finishing by customary cleaning, filling, sanding, dusting, puttying operation, notify Owner immediately for clarification.
 5. Do not proceed with installation in areas of discrepancy until such discrepancies have been fully resolved.
 6. Measure moisture content of surfaces using an electronic moisture meter. Do not apply finishes unless moisture content of surfaces are below the following maximums or as required by paint materials manufacturer: (submit written documentation by paint manufacturer).
 - a. Plaster and Gypsum Wallboard: 12 percent.
 - b. Masonry, Concrete and Concrete Unit Masonry: 12 percent.
 - c. Interior Located Wood: 15 percent, measured in accord with ASTM D 2016.
 7. Beginning of installation means acceptance of existing surfaces or substrate.

3.2 Preparation

- A. General
1. Protection: Prior to all surface preparation and painting operation, completely mask, remove or otherwise adequately protect all hardware, accessories, machined surfaces, plates, lighting fixtures and similar items in contact with painted surfaces, but not scheduled to receive paint.

2. Priming:
 - a. Spot prime all exposed nails and other metals which are to be painted with emulsion paints using a primer recommended by the Manufacturer of the coating system.
 - b. Back prime interior trim before installation, with interior trim primer.
 3. Cleaning:
 - a. Before applying paint or other surface treatment, thoroughly clean all surfaces involved.
 - b. Previously Painted Surfaces:
 - (1) Remove all blistered, peeling and scaling paint to bare substrate. Remove heavy chalk by scrubbing with seal and water. Sand or etch any glossy areas and dust clean. Clean and spot prime any failed areas. Rinse clean and let dry. Any existing mildew on the surface must be completely killed and remove before applying paint.
 - (2) Efflorescence should be removed from masonry surfaces. Rusted or abraded areas on painted metal should be thoroughly hand or power toll cleaned and spot primed. For optimum performance in more corrosive areas, entire metal surface should be abrasive blast cleaned. In all cases if the old paint shows poor adhesion, it shall all be removed and the entire surface primed.
 - (3) Where new work joints existing work, prepare existing surfaces extending to the nearest break in the plane.
 - (4) Wash surfaces with detergent and water or other solution as required to remove any accumulated dirt, oil, grease or other foreign matter which would impair bond or bleed through new finishes. After washing, rinse with water and allow to dry thoroughly.
 - c. Schedule all cleaning and painting so that dust and other contaminants from the cleaning process will not fall on wet, newly painted surfaces.
 - d. Work will be received broom clean only from General Contractor. Note protection and cleaning required by Painting Contractor.
- B. Wood Surfaces
1. Cleaning: Clean all wood surfaces until they are free from dirt, oil and other foreign substances. Remove all pencil marks and grade stamps, sanding when a semi-transparent finish is to be applied. All loose wood fibers or dust should be removed by brushing.
 2. Smoothing:
 - a. Unless specifically noted to be left rough, smooth all finished wood surfaces exposed to view, using the proper sandpaper, the dust off.
 - b. Where so required, use varying degrees of coarseness in sandpaper to produce uniformly smooth and unmarred wood surfaces.
 3. Dryness: Unless specifically approved by the Owner, do not proceed with the painting of wood surfaces
- C. Masonry
1. Fill cracks and irregularities with portland cement grout to provide uniform surface texture.
 2. Fill concrete masonry unit surfaces with block filler.

D. Ferrous Metal Surfaces

1. Thoroughly clean all surfaces until they are completely free from dirt, oil, rust, scale or grease. When heavy coatings of scale are evident, remove by wire brushing or sandblasting; clean by washing with solvent. Apply a treatment of phosphoric acid solution, ensuring weld joints, bolts and nuts are similarly cleaned. Spot prime paint after repairs.
2. Allow to dry thoroughly before application of paint.
3. Shop Primed Steel Surfaces: Sand and scrape to remove loose primer and rust. Feather edges to make touch-up patches inconspicuous. Clean surfaces with solvent. Prime bare steel surfaces. Prime metal items including shop primed items.

3.3 Paint Application

A. General

1. Workmanship: Very best, spread materials evenly, glow on smoothly without runs, sags, employ skilled mechanics.
2. Use materials only as specified by Manufacturer's direction label on container.
3. Where interior or exterior wood and metal are primed in the mill or ship, use material in every case same as the specified for such surfaces; use as per Manufacturer's directions for first or priming coat.
4. Finish door tops, bottoms, edges, same as balance of doors after they are fitted.
5. Cover surfaced to be stained with uniform stain coat; wipe off as required.
6. Sand smoothly woodwork to be finished with stain. Clean surface before proceeding with first coat application. Use fine sand paper between coats. Finish wood or metal to produce even, smooth finish.
7. Do not apply finishes to surfaces that are not dry.
8. Each coat shall cover preceding coat, so that preceding coat shall not show through. Each coat of paint shall be slightly darker than preceding coat unless otherwise directed. Undercoats shall be tinted similar to finish coats. Color of priming shall be lighter than body coat. Body coat shall be same color but lighter than finish coat.
9. Paint all surfaces, except glass, flat concrete and similar items, not pre-finished and not called out as unfinished.
10. Apply paint enamel stain and varnish with suitable brushes, or rollers, or spraying equipment.
 - a. Rate of application shall not exceed that as recommended by paint Manufacturer for the surface involved.
 - b. Keep brushes, and rollers, and spraying equipment clean, dry, free from contaminates and suitable for the finish required.
 - c. Apply stain by brush.
11. Finish coats shall be smooth, free of brush marks, streaks, laps or pile up of paints, and skipped or missed areas.
 - a. Finished metal surfaces shall be free of skips, voids or pinholes in any coat when tested with a low voltage detector. Test required on first application.
12. Make edges of paint adjoining other materials or colors clean and sharp with no overlapping.
13. Apply primer on all work before glazing.
14. Refinish whole wall where portion of finish has been damaged or is not acceptable.
15. Finish metal doors and frames to be Manufacturer's standard primed (not finish coated); finish coats by Painting Contractor.
16. No overhead doors or rolling steel doors should be painted. Rolling steel door track and all tube steel door jambs are scheduled to be painted.

17. All ceilings to be painted except acoustical tile ceilings. See schedules.

B. Drying

1. Allow sufficient drying time between coats.
2. Modify the period as recommended by the material Manufacturer to suit adverse weather conditions.

C. Environmental Conditions

1. Comply with the Manufacturer's recommendations as to environmental conditions under which the coating system may be applied. No painting allowed when temperatures are below 50 degrees F., above 120 degrees F. or with 90% or above relative humidity.
2. Do not apply paint in areas where dust is being generated.

D. Defects: Sand and dust between coats to remove all defects visible to the unaided eye from a distance of five feet.

E. Dry Mil Thickness

1. General: Apply all coatings to the dry mil thickness indicated in the "Painting Schedule". In general all painted surfaces to have a DFT as listed unless noted otherwise.

F. Recoating

1. Whenever possible, notify Architect between coats.

3.4 Reinstallation of Removed Items: Following completion of painting, in each space, promptly reinstall all items removed for painting or wall covering using only workmen skilled in the particular trade.

3.5 Cleaning Up

A. General

1. During progress of the Work, do not allow the accumulation of empty containers or other excess items except in areas specifically set aside for the purpose.
2. Prevent accidental spilling of paint materials and in event of such spill, immediately remove all spilled material and the waste or other equipment used to clean up the spill, and wash the surfaces to their original undamaged condition, all at no additional cost to the Owner.
3. Collect cotton waste, cloths and material which may constitute a fire hazard, place in closed metal containers and remove daily from site.
4. Touch up and restore finish where damaged.
5. Do not mar surface finish of item being cleaned.
6. Leave storage space clean and in condition required for equivalent spaces in project.

B. Prior to Final Inspection: Upon completion of this portion of the Work visually inspect all surfaces and remove all paint and traces of paint from surfaces not scheduled to be painted.

3.6 Painting Schedule

- A. Surfaces Not to be Painted.
 - 1. Pre-finished wall, ceiling and floor coverings.
 - 2. Items with factory applied final finish.
 - 3. Concealed ducts, pipes and conduit.
 - 4. Glass, flat concrete and similar items, not pre-finished.
 - 5. Ceramic tile, acoustical tile and plastic laminate.

- B. Exterior Work (use only exterior quality materials)
 - 1. Exterior Ferrous Metals:
 - a. Touch-up: Rust-inhibitive waterborne acrylic primer, free of heavy metals;
Min. DFT: 2.5 - 5.0 mils
Min. Volume Solids: 44%
 - b. 2nd Coat: Non-blocking, 100% acrylic gloss coating
 - c. 3rd Coat: Non-blocking, 100% acrylic gloss coating; Min. DFT: 1.3 mils per coat;
Min. Volume Solids: 31%;
Sheen: 70-90 units at 60 degrees.

- C. Interior Work
 - 1. Interior Wood - transparent finish:
 - a. First Coat: VOC compliant wiping stain; spreading rate: as needed to match Owner's sample.
 - b. 2nd Coat: Polyurethane satin varnish
 - c. 3rd Coat: Polyurethane satin varnish:
Min DFT: 1.7 mils per coat;
Min. Volume Solids: 41%;
Sheen: 20-35 units at 60 degrees.
 - 2. Interior Wood - painted
 - a. First Coat: 100% acrylic primer;
Min. DFT: 1.6 mils; Min. Volume Solids: 39%
 - b. 2nd Coat: Non-blocking, acrylic semi-gloss
 - c. 3rd Coat: Non-blocking, acrylic semi-gloss Pencil Hardness (ASTM D3363): H or harder;
Min. DFT: 1.3 mils per coat;
Min. Volume Solids: 33%;
Sheen: 35-45 units at 60 degrees.
 - 3. Concrete (scheduled for epoxy)
 - a. First Coat: 100% acrylic, alkali resistant primer;
Min DFT: 3.0 mils;
Min Volume Solids: 37%;
Alkali Resistance: tolerance of PH levels up to 13.
 - b. 2nd Coat: 2-component water based catalyzed epoxy
 - c. 3rd Coat: 2-component water based catalyzed epoxy
DFT: 2.5 - 3.0 mils per coat
Min Volume Solids: 38% (catalyzed)
Sheen: 20 - 30 units at 60 degrees.
 - 4. Concrete Masonry Units:
 - a. First Coat: Vinyl acrylic blockfiller
Min DFT: 8.0 mils; (50-90 sq.ft./gal)
Min Volume Solids: 53.5%

- b. 2nd Coat: 2-component water based catalyzed epoxy
- c. 3rd Coat: 2-component water based catalyzed epoxy
Min DFT: 2.5 - 3.0 per coat;
Min Volume Solids: 38% (catalyzed)
Sheen: 20-30 units at 60 degrees.
- 5. Concrete (scheduled for Latex - E)
 - a. First Coat: 100% acrylic, alkali resistant primer
Min. DFT: 3.0 mils per coat Min.
Volume Solids: 37%
Alkali Resistance: tolerance of PH levels up to 13
 - b. Second Coat: Vinyl acrylic finish
 - c. Third Coat: Vinyl acrylic eggshell finish
Min. DFT: 1.6 mils per coat Min.
Volume Solids: 37%
Sheen: 10 - 20 units at 85 degrees
- 6. Concrete (scheduled for Latex - S)
 - a. First Coat: 100% acrylic, alkali resistant primer
Min. DFT: 3.0 mils per coat Min.
Volume Solids: 37%
Alkali Resistance: tolerance of PH levels up to 13
 - b. Second Coat: Vinyl acrylic semi-gloss finish
 - c. Third Coat: Vinyl acrylic semi-gloss finish
Min. DFT: 1.6 mils per coat Min.
Volume Solids: 37%
Sheen: 25 - 35 units at 60 degrees
- 7. Concrete masonry units (scheduled for Latex - E)
 - a. First Coat: Vinyl acrylic blockfiller
Min. DFT: 8.0 mils (75-125 sq.ft./gallon)
Min. Volume Solids: 48%
 - b. Second Coat: Vinyl acrylic eggshell finish
 - c. Third Coat: Vinyl acrylic eggshell finish
Min. DFT: 1.6 mils per coat
Min. Volume Solids: 37%
Sheen: 10 - 20 units at 85 degrees
- 8. Concrete masonry units (scheduled for Latex - S)
 - a. First Coat: Vinyl acrylic blockfiller
Min. DFT: 8.0 mils (75-125 sq.ft./gallon)
Min. Volume Solids: 48%
 - b. Second Coat: Vinyl acrylic semi-gloss finish
 - c. Third Coat: Vinyl acrylic semi-gloss finish
Min. DFT: 1.6 mils per coat
Min. Volume Solids: 37%
Sheen: 25 - 35 units at 60 degrees
- 9. Interior Ferrous Metal:
 - a. Touch-up: Rust-inhibitive waterborne acrylic primer,
free of heavy metals; Min. DFT:
2.5 - 5.0 mils Min. Volume Solids:
44%
 - b. 2nd Coat: Non-blocking, acrylic semi-gloss
 - c. 3rd Coat: Non-blocking, acrylic semi-gloss coating; Pencil Hardness
(ASTM D3363): H or harder

Min. DFT: 1.3 mils per coat; Min.
Volume Solids: 33%;
Sheen: 35-45 units at 60 degrees.

10. Interior Zinc-coated metal:

- a. First Coat: Rust-inhibitive waterborne acrylic primer, free of heavy metals;
Min. DFT: 2.5 - 5.0 mils
Min. Volume Solids: 44%
- b. 2nd Coat: Non-blocking, acrylic semi-gloss
- c. 3rd Coat: Non-blocking, acrylic semi-gloss
Pencil Hardness (ASTM D3363): H or harder
Min. DFT: 1.3 mils per coat; Min.
Volume Solids: 33%
Sheen: 35-45 units at 60 degrees.

11. Exposed Overhead Work:

- a. Touch-up Rust-inhibitive Oil- Based acrylic primer, free of heavy metals.
- b. DFT: 2.5 - 5.0 mils
- c. Min. volume solids: 44%
- d. 2nd Coat: Oil- Based flat dryfall
- e. DFT: 3.0 - 5.0 mils
- f. Min. volume Solids: 40%
- g. Sheen: 0-5 at 80 degrees.

D. Finishing Mechanical and Electrical Equipment

- 1. Paint in finished areas only and on exterior of building, exposed or visible galvanized metal ducts, hangers, sheet metal work, conduit boxes, brackets, collars, supports, exposed covered and uncovered plumbing, heating and other piping and conduit. See Mechanical and Electrical Drawings for extent of such work. Do not include painting of pipes, ducts, conduit, etc. in mechanical rooms and other unfinished areas unless specifically noted.
- 2. Piping or ducts to be hidden above ceilings or in pipe chases will not be painted.
- 3. Paint plumbing, heating, ventilating and electrical equipment not furnished with factory finish e.g. grilles, louvers, covers and access panels. Equipment furnished with a prime coat shall receive 2 coats of enamel in colors as selected.
- 4. Paint bright metal portion and interior surfaces of ductwork convectors and baseboard heating cabinets that is visible through grilles and louvers with one coat of flat black paint to the limits of sight lines. Paint dampers exposed behind louvers, grilles and convectors and baseboard cabinets to match face panels.
- 5. Remove oil or grease from piping and ductwork and apply one coat of primer compatible with surface being finished and with painting material being used for finished coats.
- 6. In general, exposed covered or uncovered piping and ductwork will be finished with the same materials, number or finish coats of paint and color as the surface to which they are attached.
- 7. Replace identification markings on mechanical or electrical equipment when painted accidentally.
- 8. Paint both sides and edges of plywood backboards for electrical and telephone equipment before installing equipment.

* * * * *

THIS PAGE INTENTIONALLY LEFT BLANK

SECTION 13 34 19 METAL BUILDING SYSTEMS

SCOPE Applicable provisions of the General and Supplementary Conditions and Division 1 govern work under this Section.

INDEX	1.1 Description	1.7 Warranties
	1.2 Quality Assurance	2.1 Materials
	1.3 Submittals	2.2 Acceptable Manufacturers
	1.4 Product Delivery, Storage and Handling	2.3 Fabrication
	1.5 Job Conditions	3.1 Surface Conditions
	1.6 Alternatives	3.2 Preparation
		3.3 Erection

PART 1 GENERAL

1.1 Description

- A. Work Included: This Specification covers the material for and the fabrication of metal buildings as described herein and shown on the Drawings. The materials to be furnished and installed shall include the structural framing, roofing panels, wall panels, fasteners, sealants, and/or caulking, accessories, anchor bolts, connections, gutters, downspouts, roof leaders, sleeves, insulation, and any other component parts for the metal building. This Contractor will also obtain approvals from all regulatory agencies and provide erection of the complete building. The structural design shall include bracing and reinforcing for all crane and conveyor loads.
- B. Related Work Specified Elsewhere
- | | |
|----------------------|------------------|
| 1. Concrete | Section 03 30 00 |
| 2. Masonry | Section 04 20 00 |
| 3. Steel Framing | Section 05 12 00 |
| 4. Sheet metal | Section 07 60 00 |
| 5. Glass and Glazing | Section 08 80 00 |
| 6. Painting | Section 09 91 00 |
| 7. Plumbing | Division 22 |
| 8. HVAC | Division 23 |
| 9. Electrical | Division 26 |
- C. Work Installed but Furnished by Others:
- D. Work Furnished but not Installed
- | | |
|-------------------------------|------------------|
| 1. Anchor bolts - base plates | Section 03 30 00 |
|-------------------------------|------------------|
- E. Description of System
1. Beam and Column Framing
 2. Secondary Framing: Purlins, girts, eave struts, flange bracing, sill supports, clips, and other items detailed.
 3. Roof System: Preformed metal panels of vertical profile, with girt, anchorage fasteners, insulation, liner sheets and accessory components as noted on drawings.
- F. Definitions: Refer to "Metal Building Systems Nomenclature" of the Metal Building

Manufacturers Association.

1.2 Quality Assurance

- A. Qualifications of Manufacturers: The Manufacturer of the building system used shall have been in the manufacture of metal buildings for at least 5 years; shall have the capabilities of supplying the specified materials in the quantities required to meet the construction schedule; shall have full engineering capabilities to meet all design requirements; and shall be able to transport the material to the job site.
- B. Qualifications of Metal Building Contractor
1. 5 years experience in the sale and erection of metal building type specified.
 2. A licensed supplier of the Manufacturer whose system is selected for the Work.
 3. Incorporated to do work as specified in applicable building codes.
 4. Have the resources necessary to maintain the construction schedule.
- C. Qualifications of Installer
1. A firm with a least 5 years experience in the type of work required that will be under the direct supervision of the metal building Contractor.
 2. Qualifications of Welders: AWS D 1.1
- D. Design Criteria
1. Structural Design
 - a. Design responsibility: The entire building system shall be designed by a Registered Professional Engineer employed by the Manufacturer. Any system required as specified in applicable Building Codes shall bear the stamp of a professional engineer registered in WI. The system shown is given as a guide to the required design. The final design is the responsibility of this contractor. Any load changes to the footings will be the responsibility of this contractor and the General Contractor.
 - b. Loading
 - (1) Initial handling and erection stresses.
 - (2) All dead and live loads as specified on the Contract Drawings and as required by the State of WI Building Code.
 - (3) All other loads specified for members where they are applicable.
 - (4) Wind load: Applied to the main frame as specified in the "Recommended Design Practices Manual" of the Metal Building Manufacturers Association.
 - (5) Load combinations shall be:
 - (a) Dead load plus live load.
 - (b) Dead load plus wind load.
 - (c) Dead load plus live load plus wind load.
 - (6) Equipment loads etc. shown on Roof Framing Plan and HVAC drawings.
 - (7) No live load reductions allowed in computing column loads for future floors.
 - (8) Exterior wall and roof system to withstand imposed loads with maximum allowable deflection of span: L/360 for the office addition and L/240 for the west bay addition.
 2. Provide drainage to exterior for water entering or condensation occurring within cladding system.
 3. Assembly to permit movement of components without buckling, failure of joint seals, undue stress on fasteners or other detrimental affects, when subject to temperature range of minus 20 to plus 100 degrees F.

4. Size and fabricate wall and roof systems free of distortion or defects detrimental to appearance or performance.
 5. Permissible Design Deviations:
 - a. Design deviations will be permitted only after the Engineer's written approval of the Manufacturer's proposed design supported by complete design calculations and Drawings.
 - b. Design deviations shall provide an installation equivalent to the basic intent without incurring additional cost to the Owner.
- E. Allowable Tolerances: American Institute of Steel Construction, "Code of Standard Practice of Steel Buildings and Bridges".
- F. Source Quality Control
1. Material Compliance: Manufacturer will supply on request of Engineer, certificates showing mechanical, physical and strength properties of all materials supplied.
 2. Inspection of Welds shall be in accord with AWS Building Code.
 3. Inspection of Shop Painting:
 - a. Surface preparation prior to painting shall be visually evaluated for degree of cleaning by comparison with SSPC pictorial standards.
 - b. Measurement of dry film thickness of each coat of shop applied paint shall be in accord with ASTM D 1005.
 4. Inspection of field assembled high strength bolted construction shall be in accord with Section 6, AISC Specification for Structural Joints.
- G. Reference Standards
1. Applicable Building Codes.
 2. Metal Building Manufacturers Association (MBMA)
 - a. Metal Building Systems Manual
 - b. Recommended Design Practices Manual
 3. American Institute of Steel Construction (AISC)
 - a. Specifications for the Design, Fabrication, and Erection of Steel for Buildings.
 - b. Code of Standard Practices for Steel Buildings and Bridges
 4. American Welding Society (AWS)
 - a. Standard Code for Arc and Gas Welding in Building Construction
 - b. D 1.1, Structural Welding Code
 5. American Iron and Steel Institute (AISI)
 - a. Specification for the Design of Cold-formed Steel Structural Members
 - b. Design of Light Gage Steel Diaphragms
 6. Aluminum Association (AA)
 - a. Specification for Aluminum Structures
 - b. Aluminum Formed Sheet Building Sheathing Design Guide
 7. American Society for Testing and Materials (ASTM)
 - a. A 1, Carbon-Steel Rails
 - b. A 36, Structural Steel
 - c. A 53, Pipe, Steel, Black and Hot-Dipped, Zinc Coated Welded and Seamless Steel Pipe
 - d. A 164, Electrodeposited Coatings of Zinc on Steel
 - e. A 165, Electrodeposited Coatings of Cadmium on Steel
 - f. A 233,
 - g. A 307, Carbon Steel Externally Threaded Standard Fasteners
 - h. A 325, High Strength Bolts for Structural Steel Joints

- i. A 386, Zinc-coating (Hot-Dip) on Assembled Steel Products
 - j. A 446, Steel Sheet, Zinc-Coated (Galvanized) by the Hot-Dip Process, Structural (Physical) Quality
 - k. A 490, Quenched and Tempered Alloy Steel Bolts for Structural Steel Joints
 - l. A 500, Cold-Formed Welded and Seamless Carbon Steel Structural Tubing in Rounds and Shapes
 - m. A 501, Hot-Formed Welded and Seamless Carbon Steel Structural Tubing
 - n. A 515,
 - o. A 525, Steel Sheet, Zinc-Coated (Galvanized) by the Hot-Dip Process, General Requirements.
 - p. A 529, Structural Steel with 42,000 psi Minimum Yield Point
8. American National Standards Institute (ANSI)
- a. B 27.2
 - b. B 27.4
9. Commercial Standards (CS)
- a. 214,
10. Federal Specifications (FS)
- a. HH-I-521, Insulation Blankets, Thermal, Mineral Fiber
 - b. TT-E-496, Enamel, Semi-gloss, Rust-inhibiting
 - c. TT-P-31, Paint, Oil: Iron-Oxide, Ready Mixed, Red and Brown

1.3 Submittals: Within 35 days after award of Contract, and before any of the materials of this Section are delivered to the job site, submit complete to the Engineer in accordance with these Specifications; the following:

- A. Samples: Submit color samples for approval.
- B. Shop Drawings: Before foundation work begins, submit Shop Drawings for all the Work to be performed under this Section.
 - 1. Structural Steel: Show all shop and erection details including cuts, copes, connections, holes, cambers, loads, threaded fasteners, rivets, and welds. All welds, both shop and field, shall be indicated by AWS "Welding Symbols" A 2.0. Separate drawing sheet showing anchor bolt locations and installation.
 - 2. Erection Procedure: Submit descriptive data to illustrate the structural steel erection procedure, including the sequence of erection and temporary staying and bracing.
 - 3. Welding procedure: Submit written description as required to illustrate each welding procedure to be performed in specified Work.
 - 4. Field welding equipment: Submit descriptive data for field welding equipment, including type, voltage and amperage.
- C. Calculations: The designer will submit to the Engineer one set of design calculations for review. (Registered WI Engineer stamp required).

1.4 Product Delivery, Storage and Handling

- A. Protection: Use all means necessary to protect the materials of this Section before, during, and after installation and to protect the installed Work and materials of all other trades.
- B. Delivery and Handling: Handle all components in a manner consistent with their shape and design. Lift or support units only at points shown on erection drawings. Protect components from dirt and damage during transport and handling. Protect and support units during shipping.

- C. Storage at Jobsite: Deliver to job site in quantities only as needed for erection. Store location set aside by General Contractor. Store components to protect from contact with soil, staining, abrasions and general physical damage. Protect finished roof and wall panels, trim, doors, frames and sash by covering with plastic sheets.
- D. Delivery of Materials to be Installed Under Other Sections: Anchor bolts and other anchorage devices which are embedded in cast-in-place concrete or masonry construction shall be delivered to the project site in time to be installed before the start of cast-in-place concrete operations or masonry work.
- E. Replacements: In the event of damage, immediately make all repairs and replacements necessary to the approval of the Engineer and at no additional cost to the Owner.

1.5 Job Conditions

- A. Site Conditions and Scheduling: Immediately after award of the Contract this Contractor will verify with General Contractor the requirements for site access for erection and the scheduling for erection. The General Contractor will be responsible for providing this Contractor access to the site so that all erection equipment can be used.

1.6 Alternatives: The Work of this Section is affected by alternatives as described on the Drawings and in Section 01 23 00 of these Specifications.

1.7 Warranties: At completion of Work, Manufacturer will provide Owner with written warranties as follows:

- A. Manufacturer's standard warranty covering complete assembly.
- B. Weather tightness endorsement – 50 year.
- C. Extended life endorsement on coated steel.

PART 2 PRODUCTS

2.1 Materials

- A. General: All materials furnished shall meet or exceed the stated design requirements.
- B. Steel
 - 1. General: Steel shall meet or exceed the physical requirements of AISC, "Specifications for the Design" Fabrication and Erection of Structural Steel for Buildings" and/or American Iron and Steel Institutes, "Specification for the Design of Cold-Formed Steel Structural Members," whichever is applicable.
 - 2. Steel Shapes, Bars and Plates: ASTM A 36 A 529.
 - 3. Structural Steel Tubing: ASTM A 501 A 500 Grade B.
 - 4. Pipe Columns: ASTM A 53, Grade B.
 - 5. All cold formed structural material shall have a minimum yield strength of 50,000 psi.
 - 6. All rods and angles shall have a minimum yield of 36,000 psi, except the angle stock used in open web framing, which shall have a minimum yield of 50,000 psi.
 - 7. Standard Threaded Fasteners:
 - a. Standard bolts and nuts: ASTM A 307, Grade A.
 - b. Plain washers: ANSI B 27.2, Type

- c. Beveled washers: ANSI B 27.4.
 - 8. Anchor Bolts: Conform to Section 1c of ASTM A 325.
 - 9. High-Strength Threaded Fasteners: ASTM A 325.
 - a. Use high strength bolts for all bolted connections.
 - b. Bolt Holes: 1/16" larger than bolt diameter.
 - c. All bolts to have threads excluded from shear plane.
 - d. Avoid bolts in tension.
 - 10. Welding Electrodes: ASTM A 233 E 70 Series. Suitable for position and other conditions of intended use, as per container instructions.
 - 11. Plate or bar stock: ASTM A 529.
 - 12. Primer: FS-TT-P-31 White.
- C. Aluminum: The Aluminum Association's, "Specification for Aluminum Structures" and "Aluminum Formed Sheet Building Sheathing Design Guide" shall be the guide in the design of aluminum parts for building components.
- D. Non-shrink Grout: Premixed compound consisting of non-metallic aggregate, cement, water reducing and plasticizing agents, developing minimum compressive strength of 2400 psi in two days and 7000 psi in 28 days.
- E. Minimum Standards for Thickness (except as specified elsewhere)
- 1. Individual structural members of steel other than roof covering to be a minimum of 18 gage.
 - 2. Roof Covering:
 - a. Steel: minimum of 26 gage.
 - b. Aluminum: minimum of 0.032 inch thickness.
 - c. Plastic: minimum of 0.045 inch thickness.
 - 3. Gable and eave trim, fascia closure strips, rake flashing, and copings:
 - a. Steel: minimum of 26 gage.
 - b. Aluminum: minimum of 0.032" thickness.
 - c. Plastic: minimum of 0.045" thickness.
 - 4. Eave Gutters and Downspouts:
 - a. Steel: minimum of 26 gage.
 - b. Aluminum: minimum of 0.032 inch thickness.
 - 5. Use of materials of less thickness than that given above, may be allowed upon the submission of test data from approved authorities and/or calculations verifying the structural adequacy and erection feasibility of members formed from such material.
- F. Primary Framing
- 1. Beam and Column: This type of building utilizes frames with tapered or uniform dept beam or girder supported by columns. This type of framing, commonly designated as "simple" framing (unrestrained, free-ended), assumes that, insofar as gravity loading is concerned, the ends of beams, or girders, are connected to resist shear only, and are free to rotate under gravity load.
This primary framing is spaced on pre-determined bay lengths and supports the secondary framing and the roof and wall covering.
 - 2. Self-Framing: This type of building shall be a single span or multi-span structure utilizing the roof and wall covering as a load bearing diaphragm in addition to its function as an exterior skin of the building.
 - 3. Building Geometry: The roof slope, width, eave height, length of building and spacing of bents (bays) shall conform to the Manufacturers' standards covering the listed types of buildings.
- G. Secondary Framing
- 1. Purlins:

- a. Solid Purlins: Purlins shall be inches in depth and shall be designed for the specified loading conditions from 16, 15, 14, 13, 12, or 11 gage steel. Purlins shall be designed as simple span and/or continuous span and shall be "Z" shaped. They shall be pre-punched at the factory to provide for field bolting to the primary framing.
- b. Truss Purlins
 - (1) Truss purlins shall be cold-formed trusses which are factory assembled and welded.
 - (2) Purlins shall be braced on the top and bottom chords spaced at intervals shown on the erection drawings.
 - (3) All concentrated loads shall be hung at purlin panel points.
 - (4) Purlin top chords shall have factory punched holes for roof panel clip attachment.
- 2. Girts
 - a. Girts shall be inches in depth and shall be designed for the specified loading conditions from 16, 15, 14, 13, 12 or 11 gage steel. Girts shall be designed as simple span and/or continuous span and shall be "Z" shaped.
 - b. Outer flange of all girts shall have factory punched holes for panel connections.
 - c. All girt webs shall have factory punched holes for sag rod, door post and fascia frame installation.
- 3. Eave Members
 - a. Eave members shall be cold formed, C-shaped members.
 - b. Webs and outer flange of all eave members shall have factory punched holes for panel connections and for connections to truss purlins, where required.
- 4. Bracing
 - a. Wind bracing: Shall be as shown on Drawings and is to be accomplished by diagonal bracing, diaphragm action, knee bracing or portal type rigid frame.
 - b. Flange Braces shall be steel angles attached to purlin and/or girts and primary framing. The quantity and location of all brace angles shall be as dictated by design.
- 5. Base Angle: A continuous member steel angle, should be attached to the base of the wall to the foundation with expansion bolts or equivalent anchors.
 - a. See base bid of the roof and wall panel system.

H. Roof Covering

- 1. Panel Description (Varco Pruden SLR II - 2" rib / 16" wide panel or equal).
 - a. Panels shall be produced on a precision roll forming machine.
 - b. Panels of maximum possible lengths shall be used with no end laps. Lengths shall be used min. 52'-0" (or) maximum final design length.
 - c. Roof panels shall be factory pre-punched at panel end to match pre-punched holes in the eave structural member. Panel end splices shall be prepunched and prenotched.
 - d. Profile: Match Existing roof panel
 - e. Edges: Male/female, Double lock standing seam
- 2. Panel Design:
 - a. Panels shall be designed in accord with AISI Specifications for the Design of Light Gage Cold Formed Steel Structural Members and in accord with sound engineering methods and practices.
 - b. Panels shall be designed to support design live loads and roof traffic during construction.
 - c. The roof shall provide for expansion/contraction without detrimental effect on the roof panel when ambient air temperature varies ± 100 degrees F. from the temperature at which the roof was installed.

3. Panel Material
 - a. 24 gage galvanized steel (42,000 yield) conforming to ASTM A 525. Coating shall be G-90 to ASTM A 446 grade D or A 515. color choices – manufacturer's standard colors.
 - b. Gage aluminized steel - Type II MIL-S-4174A.
 - c. Inch aluminum sheet.
 4. Energy Conservation: Purlins shall be insulated so as to eliminate "thermal short circuits" between purlins and roof panels caused by compression of the blanket insulation between structural and panel.
 5. U.L. Uplift Ratings: The roof system shall carry a U. L. wind-uplift Class 90 rating, U.L. construction No.
- I. Snow Guards: Fence Style
1. Quantity: 2 rows minimum at all roof vent pipes. 2 rows minimum, more as required by system design per roof size and slope.
 2. Continuous Bar: 6000 series aluminum, mill finish. Include splice plate. Designed to support retained snow loads.
 3. Attachment Clamp Bracket: Aluminum block to be attached to standing seam flanges in such a way as not to void roof warranty. Spacing as recommended by the roofing manufacturer. All hardware to be stainless steel or aluminum.
 4. Assembly: Provided manufactured system components specifically designed for this purpose. Components to be compatible with each other and the roofing system.
- J. Wall Panels:
1. Vertical Ribbed Panels
 - a. VP Tech Four Wall Panel by Varco Pruden Buildings or equal
 - i. 16" wide panels, 2" deep profile
 - ii. Concealed fasteners system
 - iii. Standard manufacturer's warranty
 - iv. 24" gage panel – Kynar 500 finish, color to match existing building as close as possible from standard manufacturer colors.
- K. Insulation System
- Roof Insulation: R-38 fiberglass system with liner panel.
1. Insulation: Formaldehyde free, 12" total thickness fiberglass batt insulation; thermal resistance R=38; ASTM C-991, Type I / ASTM E-136 / ASTM E-84; Flame Spread Classification of 25/50 or less flame spread / smoke developed rating. Lower layer 8" and upper layer 4"
 2. Fabric Liner System:
 - a. Strapping: Corrosion resistant, 1" wide x 0.020 UVMAX strapping, 100,000 psi tensile strength. No field splicing. Color matched to fabric.
 - b. Fasteners: Color matched with sealing washers, size and type appropriate for substrate use.
 - c. Tapes and Sealants: As recommended by system manufacturer, compatible with system components.
 - d. Fabric Liner: Woven, high density polyethylene fabric which provides a Class A fire retardant rating.

Wall Insulation: R-25 fiberglass system

1. Insulation: Formaldehyde free, 8" thick fiberglass batt insulation; thermal resistance R=25; ASTM C-991, Type I / ASTM E-136 / ASTM E-84; Flame Spread Classification of 25/50 or less flame spread / smoke developed rating.
2. Vapor Barrier: 6 mil polyethylene on warm side of walls.

L. Interior Finish- Walls - Innerliner

1. White Steel: Uni-Rib - 29 Gauge, ASTM A 653 (A 653 M), Structural Quality, Grade 80 (550) formerly Grade E), galvanized steel with G60 (Z180) zinc coating both sides, Triple Spot Test.

M. Fasteners: Manufacturer's standard type, galvanized to ASTM A 386 2.0 ounces per square foot; finish to match adjacent surfaces when exterior exposed.

1. Self-tapping screws:
2. Lock-rivets:
3. Hidden clip:
4. Seaming:

N. Sealants

1. Closure strips:
2. Tape Mastic:
3. Sealant: non-staining, elastomeric, skinning.
4. Joint Seal Gaskets: Manufacturer's standard type.

O. Accessories

1. Trim:
2. Ventilators:
3. Insulation: Guardian (ES) energy saver system with FP banding; R40 – 12 inches.
4. Gutters-Downspouts:
 - a. Fabricate of same material and finish as roofing metal.
 - b. Form gutters and downspouts of profile and size to collect and remove water. Fabricate with connection pieces.
 - c. Form sections in maximum possible lengths. Hem exposed edges. Allow for expansion at joints.
5. Soffit Panels: Marquee – LOK 12" wide flat panel: Minimum 1-1/2 inch metal V thickness; crimped profile – or equal.
6. Internal and External Corners: Same material thickness and finish as adjacent material; profile shop cut and factory mitered to required angles. Back brace mitered internal corners
7. Expansion Joints: Same material and finish as adjacent material Manufacturer's standard brake formed
8. Flashings, Closure Pieces, Fascia, Infills, Caps, and same material and finish as adjacent material; profile to suit system. Foam filled base tube with anchors, galvanized.

P. Minimum Finish (except as specified elsewhere)

1. Galvanized (Zinc Coated) Steel Covering when specified shall be a minimum coating class of 1.25 ounces per square foot according to ASTM A 525. In addition, a mill treatment shall be added to aid in the prevention of oxidation on the zinc coated surfaces.

2. Aluminum Coated Steel Covering shall be a minimum of Type II Federal Specification MIL-S-4174-A (0.75 ounce per square foot).
3. Aluminum Cladding over Aluminum Covering shall be in accord with "Aluminum Standards and Data," of the Aluminum Association.
4. Pre-painted Covering-factory applied: The primer on pre-treatment shall be the building Manufacturer's standard, compatible with the metal surface to be painted as well as the finish coat of paint. The finish coat of paint, on the exposed exterior surface shall consist of a properly stabilized synthetic base coating oven dried and pigmented to obtain optimum performance. The dry film thickness shall be one mil (0.001 inch) with a tolerance of minus two tenths mil (0.0002 inch). Color shall conform to the building Manufacturer's standards. Red Primer.
5. Covering Fasteners: The minimum coating thickness for covering fasteners of carbon steel shall be 0.0003 inch electro-galvanized in accord with ASTM A 164 or 0.0003 inch cadmium plated in accord with ASTM A 165.
6. Structural Painting: All structural framing of the metal building systems, not protected by a corrosion resistant coating, is painted one coat of shop primer by the Manufacturer. All surfaces to receive shop primer are cleaned of loose rust, loose mill scale, and other foreign material by the Manufacturer prior to painting. The Manufacturer is not required to sandblast, flame clean or pickle the steel framing. The coat of primer is intended to protect the steel framing for only a short period of exposure to ordinary atmospheric conditions.
7. Dissimilar materials which are not compatible with the adjoining materials when exposed to moisture must be separated by means of coatings, gaskets or other effective means. Aluminum surfaces which may contact unprotected steel should be separated by brush-on coatings such as per Federal Specification TT-E-496, Type 1, MIL-P-6883, JAN-P-735 or equal. Aluminum alloys shall be considered compatible with zinc and cadmium coated surfaces and the 300 and 400 AISI Series Stainless Steel Alloys and do not require application of barrier material.

2.2 Acceptable Manufacturers

- | | |
|---------------------------------|---|
| A. Foremost Building, Inc. | I. Ceco Building Systems, Butler |
| B. Kirby | J. Varco Pruden Buildings |
| C. Nucor Building Systems Group | K. Approved Manufacturers |
| D. Inland Buildings | L. Canam Steel Building Corporation |
| E. Behlen Building Systems | M. Presidential Steel Buildings |
| F. Star Building System | N. American Standard Steel Building Systems |
| H. Mesco Building Solutions | O. Corle Building System |

2.3 Fabrication

- A. General: Fabricate all Work in accord with the approved Shop Drawings and referenced standards. Be responsible for accurate fit of all Work.
- B. Connections
 1. Shop Connections: Welded or bolted.
 2. Field Connections:
 - a. Provide bolted connections as follows:
 - (1) High strength threaded fasteners shall be used for bolted connections, except where standard threaded fasteners are permitted.
 - (2) High strength bolted construction assembly: tightening shall be done in

- accord with Section 5 of Specifications for Structural Joints.
- (3) Fabricator is responsible for design and strength of connections unless otherwise noted on the Drawings.

3. Holes :
- a. Punch holes as required for connection of other Work per templates and directions of such trades.
 - b. Steel requiring accurate alignment shall be provided with slotted holes and shims for truing up steel, as required for alignment.
4. Welded Construction:
- a. Welding process shall be limited to one or a combination of the following:
 - (1) Manual shielded-arc
 - (2) Submerged arc
 - b. Welded assemblies shall be stress relieved by heat treatment.
 - c. Use equipment which will supply proper current in order that operator may produce satisfactory welds. Welding machine: 200 to 400 amperes, 25-40 volts capacity.
 - d. Field welding: by direct current. Remove paint within two inches of weld.
5. Column bases shall be milled and attached to columns.
6. Bearing plates:
- a. Bearing plates shall be provided under beams, girders, columns and trusses resting on footings, piers and walls.
 - b. Bearing plates shall be either attached or loose.
- C. Identifying Marks: All fabricated or purchased items shall have an identifying number corresponding to marking shown on erection drawings. The marking shall be stamped, stenciled, tagged, or printed on these items after shop paint has been applied.
- D. Shipping: The size and weight of the building components as packaged and shipped shall be such that will permit transportation by common carrier.
- E. Painting
1. Prior to painting, the fabricator shall clean the steel of loose rust, loose mill scale, dirt, and other foreign material. Unless otherwise specified the fabricator shall not sandblast, flame clean or pickle prior to painting. The fabricator shall then factory coat all steel with one coat of zinc chromate alkyd primer formulated to equal or exceed the performance requirements of Federal Specifications TT-P-636.
 - a. All purlins shall be dip tank coated by an electro-deposition method.
 - b. All other structural steel components and sub-assembly parts shall be spray painted.
 2. The shop coat of paint is a primer and is intended to protect the steel for a short period of exposure. Subsequent finish painting, if required, is to be performed in the field by others.

PART 3 EXECUTION

3.1 Surface Conditions

- A. Inspection: Before fabrication or erection examine the Site, inspect bearing surfaces, take field measurements, and carefully inspect the installed Work of all other trades and verify that all such Work is complete and that the Work of this Section can be installed in accord with the original design and approved Shop Drawings. In the event of discrepancies, notify Engineer immediately for clarification. Do not proceed with the

work of this Section until all such discrepancies have been fully resolved.

3.2 Preparation

- A. Supply the General Contractor with all anchor bolts, setting plates, bearing pads or other built-in items required for this Work.
- B. Site Access: The General Contractor shall be responsible for providing suitable access to the building and firm level bearing for the hauling and erection equipment to operate under their own power.
- C. The General Contractor shall be responsible for providing true, level bearing surfaces on all field placed bearing walls and other field placed supporting members.

3.3 Erection

- A. Column Bases and Bearing Plates:
 - 1. Attached column bases and bearing plates for beams and similar structural members shall be aligned with wedges or shims.
 - 2. Loose column bases and bearing plates which are too heavy to be placed without a derreck or crane shall be set and wedged or shimmed.
 - 3. Set column base plates with non-shrink grout to full plate bearing.
- B. Framing
 - 1. Erect framing in accord with AISC Specifications.
 - 2. Provide for erection and wind loads. Provide temporary bracing to maintain structure plumb and in alignment until completion of erection and installation of permanent bracing. (Locate braced bays as indicated)
 - 3. Structural steel frames shall be accurately assembled to the lines and elevations indicated, within the specified erection tolerances.
 - 4. The various members forming parts of a complete frame or structure after being assembled shall be aligned and adjusted accurately before being fastened.
 - 5. Fastening of splices of compression members shall be done after the abutting surfaces have been brought completely into contact.
 - 6. Bearing surfaces and surfaces which will be in permanent contact shall be cleaned before the members are assembled.
 - 7. Splices shall be permitted only where indicated.
 - 8. Use drift pins only for bringing members into position, not to enlarge or distort holes.
 - 9. Erection bolts used in welded construction may be either tightened securely and left in place or removed and the holes filled with plug welds.
 - 10. Give special attention to steel handling during construction to void overloading green floor slabs; adhere to Engineer's instructions when criticisms are made in this regard.
 - 11. Gas Cutting:
 - a. Field correcting of fabrication by gas cutting shall not be permitted on any major member in the structural framing without prior approval of the Engineer.
 - b. Cut out and reinforce, as indicated and/or required, holes through webs of members for mechanical Work. Verify exact locations with heating and ventilating Contractor.

B. Touch up: At completion of erection touch-up prime coat of paint at all welds, abraisions, bolts etc. with same material used for shop coat.

* * * * *

THIS PAGE LEFT INTENTIONALLY BLANK

**SECTION 22 05 00
COMMON WORK RESULTS FOR PLUMBING**

PART 1 - GENERAL

SCOPE

This section includes information common to two or more technical plumbing specification sections or items that are of a general nature, not conveniently fitting into other technical sections. Included are the following topics:

PART 1 - GENERAL

- Scope
- Related Work
- Reference
- Standards
- Quality Assurance
- Protection of Finished Surfaces
- Sleeves and Openings
- Sealing and Firestopping
- Equipment Furnished By Others
- Provisions for Future
- Off Site Storage
- Codes
- Request and Certification for Payment
- Certificates and Inspections
- Operating and Maintenance Data
- Record Drawings

PART 2 - PRODUCTS

- Access Panels and Doors
- Identification
- Sealing and Firestopping
- Bedding and Backfill

PART 3 - EXECUTION

- Excavation and Backfill
- Sheeting, Shoring and Bracing
- Dewatering
- Surface Repair
- Concrete Work
- Cutting and Patching
- Building Access
- Equipment Access
- Coordination
- Identification
- Lubrication
- Sleeves
- Sealing and Firestopping

RELATED WORK

- Section 22 13 53 – Septic System
- Section 33 21 00 – Well System
- Division 21 00 00 – Fire Protection

REFERENCE

Applicable provisions of Division 1 govern work under this section.

This section applies to all Division 22 00 00 sections of plumbing.

STANDARDS

Abbreviations of standards organizations referenced in this and other sections are as follows:

AMCA Air Movement and Control Association
ANSI American National Standards Institute
ARI Air Conditioning and Refrigeration Institute
ASME American Society of Mechanical Engineers
ASPE American society of Plumbing Engineers
ASSE American Society of Sanitary Engineering
ASTM American Society for Testing and Materials
AWWA American Water Works Association
AWS American Welding Society
CISPI Cast Iron Soil Pipe Institute
CGA Compressed Gas Association
CS Commercial Standards, Products Standards Sections, Office of Eng. Standards Service, NBS
EPA Environmental Protection Agency
FS Federal Specifications, Superintendent of Documents, U.S. Government Printing Office
GAMA Gas Appliance Manufacturers Association
IAPMO International Association of Plumbing & Mechanical Officials
IEEE Institute of Electrical and Electronics Engineers
ISA Instrument Society of America
MCA Mechanical Contractors Association
MICA Midwest Insulation Contractors Association
MSS Manufacturer's Standardization Society of the Valve & Fitting Industry, Inc.
NBS National Bureau of Standards
NEC National Electric Code
NEMA National Electrical Manufacturers Association
NFPA National Fire Protection Association
NSF National Sanitation Foundation
PDI Plumbing and Drainage Institute
SMACNA Sheet Metal and Air Conditioning Contractors' National Association. Inc.
UL Underwriters Laboratories Inc.

Standards referenced in this section:

ACI 614 Recommended Practice for Measuring, Mixing and Placing of Concrete
ASTM D1557 Standard Test Method for Moisture-Density Relations of Soils
ASTM E814 Standard Test Method for Fire Tests of Through-Penetration Fire Stops
ASTM E84 Standard Test Method for Surface Burning Characteristics of Building Materials
UL1479 Fire Tests of Through-Penetration Firestops
UL723 Surface Burning Characteristics of Building Materials

QUALITY ASSURANCE

Substitution of Materials: Refer to Section GC - General Conditions of the Contract, Equals and Substitutions.

All products and materials used are to be new, undamaged, clean and in good condition. Existing products and materials are not to be reused unless specifically indicated.

Where equipment or accessories are used which differ in arrangement, configuration, dimensions, ratings, or engineering parameters from those indicated on the contract documents, the contractor is responsible for all costs involved in integrating the equipment or accessories into the system and for obtaining the intended performance from the system into which these items are placed.

PROTECTION OF FINISHED SURFACES

Refer to Division 1, General Requirements, Protection of Finished Surfaces.

SLEEVES AND OPENINGS

Refer to Division 1, General Requirements, Sleeves and Openings.

SEALING AND FIRESTOPPING

Sealing and firestopping of sleeves/openings between piping, etc. and the sleeve or structural opening shall be the responsibility of the contractor whose work penetrates the opening. The contractor responsible shall hire individuals skilled in such work to do the sealing and fireproofing. These individuals hired shall normally and routinely be employed in the sealing and fireproofing occupation.

EQUIPMENT FURNISHED BY OTHERS

There are many systems that the Plumber will have to connect to and interface with:

Well Water Supply

Septic Tank

Fire Protection System

OFF SITE STORAGE

Prior approval by the A/E will be needed. The contractor shall submit Storage Agreement Form for consideration of offsite materials storage. Generally, sleeves, pipe/pipe fittings and similar rough-in material will not be accepted for off site storage. No material will be accepted for off site storage unless shop drawings for the material have been approved.

CODES

Comply with requirements of Wisconsin Administrative Code.

REQUEST AND CERTIFICATION FOR PAYMENT

Within 10 days after Notice to Proceed, the successful bidder will submit to the Project Representative in a form prescribed below and by the General Conditions of the Contract - Scheduling and Coordination of Work, Reports, Records and Data, Payments to Contractor, a cost breakdown of the proposed values for work performed which, if approved by Owners Rep, will become the basis for construction progress and monthly payments. The cost breakdown items shall reflect actual work progress stages as closely as feasible.

In addition, if payment is requested for approved off-site stored material, then that material shall be listed as a line item in the request and certification for payment cost breakdown.

CERTIFICATES AND INSPECTIONS

Refer also to Division 1, General Conditions, Permits, Regulations, Utilities and Taxes.

Obtain and pay for all required State installation inspections except those provided by the Architect/Engineer in accordance with State of Wisconsin. Deliver originals of these certificates to the Owner's Project Representative. Include copies of the certificates in the Operating and Maintenance Instructions.

SUBMITTALS

Refer to Division 1, General Conditions, Submittals.

Not more than two weeks after award of contract but before any shop drawings are submitted, contractor to submit the following plumbing system data sheet. List piping material type for each piping service on the project, ASTM number, schedule or pressure class, joint type, manufacturer and model number where appropriate. List valves and specialties for each piping service, fixture and equipment with manufacturer and model number. The approved plumbing system data sheet(s) will be made available to the Project Representative for their use on this project.

PLUMBING SYSTEM DATA SHEET

<u>Item</u>	<u>Pipe Service/Sizes</u>	<u>Manufacturer/Model No.</u>	<u>Remarks</u>
Pipe Systems			
Plbg. Specialties			
Pipe Specialties			
Hangers & Supports			
Insulation			
Valves			
Plbg. Fixtures			
Plbg. Equipment			

Shop drawing submittals are to be bound, labeled, contain the project manual cover page and a material index list page showing item designation, manufacturer and additional items supplied with the installation. Submit for all equipment and systems as indicated in the respective specification sections, marking each submittal with that specification section number. Mark general catalog sheets and drawings to indicate specific items being submitted and proper identification of equipment by name and/or number, as indicated in the contract documents. Include wiring diagrams of electrically powered equipment.

Submit sufficient quantities of data sheets and shop drawings to allow the following distribution:

- Operating and Maintenance Manuals 2 copies
- Architect/Engineer 2 copy

OPERATION AND MAINTENANCE DATA

All operations and maintenance data shall comply with the submission and content requirements specified under section GENERAL REQUIREMENTS.

In addition to the general content specified under GENERAL REQUIREMENTS supply the following additional documentation:

1. Records of tests performed to certify compliance with system requirements
2. Manufacturer's wiring diagrams for electrically powered equipment
3. Certificates of inspection by regulatory agencies
4. Valve schedules
5. Lubrication instructions, including list/frequency of lubrication
6. Parts lists for fixtures, equipment, valves and specialties.
7. Manufacturers installation, operation and maintenance recommendations for fixtures, equipment, valves and specialties.
8. Additional information as indicated in the technical specification sections

TRAINING OF OWNER PERSONNEL

Instruct user agency personnel in the proper operation and maintenance of systems and equipment provided as part of this project. Include not less than 4 hours of instruction, using the Operating and Maintenance manuals during this instruction. Demonstrate startup, operation and shutdown procedures for all equipment. All training to be during normal working hours. Videotape all instructions and provide Owner with copy.

RECORD DRAWINGS

Refer to Division 1, General Requirements, Record Drawings.

PART 2 - PRODUCTS

ACCESS PANELS AND DOORS

LAY-IN CEILINGS:

Removable lay-in ceiling tiles in 2 X 2 foot or 2 X 4 foot configuration provided under Section 09500 are sufficient; no additional access provisions are required unless specifically indicated.

DRYWALL WALLS AND CEILINGS:

16 gauge frame with not less than a 20 gauge hinged door panel, prime coated steel for general applications, stainless steel for use in toilets, showers, and similar wet areas, concealed hinges, screwdriver operated cam latch for general applications, key lock for use in public or secured areas, UL listed for use in fire rated partitions if required by the application. Use the largest size access opening possible, consistent with the space and the item needing service; minimum size is 16" by 16".

IDENTIFICATION

NON POTABLE WATER SYSTEMS (WATER REUSE):

Shall conform to SPS 382.40.

Not less than 1 inch high letters/numbers for marking pipe and equipment

STENCILS:

Not less than 1 inch high letters/numbers for marking pipe and equipment.

VALVE TAGS:

Round brass tags with 1/2 inch numbers, 1/4 inch system identification abbreviation, 1-1/4 inch minimum diameter, with brass jack chains, brass "S" hooks or one piece nylon ties around the valve stem, available from EMED Co., Seton Name Plate Company, or W. H. Brady.

UNDERGROUND WARNING TAPE:

Detectable underground warning tape, 5.0 mil overall thickness, 6" width, .0035" thick aluminum foil core with polyethylene jacket bonded to both sides. Color code tape and print caution along with name of buried service in bold letters on face of tape. Thor Enterprises Magnatec or equal by Carlton, MSI Marking Services, Seton.

UNDERGROUND TRACER WIRE:

All underground non-metallic sewers/mains and water services/mains shall be provided with tracer wire installations. Tracer wire installations shall conform with Section 182.0715(2r) of Wisconsin Statutes and prevailing Department of Commerce Chapter 84 requirements. Tracer wire shall be continuous solid copper or steel plastic coated with split bolt or compression-type connectors.

BEDDING AND BACKFILL

Bedding up to a point 12" inches above the top of the pipe shall be thoroughly compacted sand or crushed stone chips meeting the following gradations:

<u>Gradation for Bedding Sand</u>		<u>Gradation for Crushed Stone Chip Bedding</u>	
<u>Sieve Size</u>	<u>% Passing (by Wt)</u>	<u>Sieve Size</u>	<u>% Passing (by Wt)</u>
1 inch	100	1/2 inch	100
No. 16	45 - 80	No. 4	75 - 100
No. 200	2 - 10	No. 100	10 - 25

Backfill above the bedding in lawn areas shall be thoroughly compacted excavated material free of large stones, organic, perishable, and frozen materials.

Backfill above the bedding under existing and future utilities, paving, sidewalks, curbs, roads and buildings shall be granular materials, pit run sand, gravel, or crushed stone, free from large stones, organic, perishable, and frozen materials.

SEALING AND FIRESTOPPING

FIRE AND/OR SMOKE RATED PENETRATIONS:

Manufacturers: 3M, Hilti, Rectorseal, STI/SpecSeal, Tremco, or approved equal.

All firestopping systems shall be provided by the same manufacturer.

Fire stop systems shall be UL listed or tested by an independent testing laboratory approved by the WI-DSPS.

Submittals: Contractor shall submit product data for each firestop system. Submittals shall include product characteristics, performance and limitation criteria, test data, MSDS sheets, installation details and procedures for each method of installation applicable to this project. For non-standard conditions where no UL tested system exists, submit manufacturer's drawings for UL system with known performance for which an engineering judgement can be based upon.

Use a product that has a rating not less than the rating of the wall or floor being penetrated. Reference architectural drawings for identification of fire and/or smoke rated walls and floors.

Use firestop putty, caulk sealant, intumescent wrapstrips, intumescent firestop collars, firestop blocks, firestop mortar or a combination of these products to provide a UL listed system for each application required for this project. Provide mineral wool backing where specified in manufacturer's application detail.

NON-RATED PENETRATIONS:

At pipe penetrations of non-rated interior partitions, floors and exterior walls, use urethane caulk in annular space between pipe insulation and sleeve. For non-rated drywall, plaster or wood partitions where sleeve is not required use urethane caulk in annular space between pipe insulation and wall material

PART 3 - EXECUTION

EXCAVATION AND BACKFILL

Perform all excavation and backfill work necessary to accomplish indicated plumbing systems installation. Excavate to bottom of pipe and structure bedding, 4" in stable soils, 6" in rock or wet trenches and 8" in unstable soil. Finish bottoms of excavations to true, level surface.

At no time place excavated materials where they will impede surface drainage unless such drainage is being safely rerouted away from the excavation.

Excavate whatever materials are encountered as required to place at the elevations shown, all pipe, manholes, and other work. Remove debris and rubbish from excavations before placing bedding and backfill material.

Remove surplus excavated materials from site.

Verify the locations of any water, drainage, gas, sewer, electric, telephone or steam lines which may be encountered in the excavation. Underpin and support all lines. Cut off service connections encountered which are to be removed at the limits of the excavation and cap.

Provide and maintain all fencing, barricades, signs, warning lights, and/or other equipment necessary to keep all excavation pits and trenches and the entire subgrade area safe under all circumstances and at all times. No excavation shall be left unattended without adequate protection.

Elevations shown on the plans are subject to such revisions as may be necessary to fit field conditions. No adjustment in compensation will be made for adjustments up to two (2) feet above or below the grades indicated on the plans.

Install lines passing under foundations with minimum of 1-1/2 inch clearance to concrete and insure there is no disturbance of bearing soil.

Bed pipe up to a point 12" above the top of the pipe. Take care during bedding, compaction and backfill not to disturb or damage piping.

Mechanically compact bedding and backfill to prevent settlement. The initial compacted lift to not exceed 24" compacted to 95% density per Modified Proctor Test (ASTM D-1557). Subsequent lifts under pavements, curbs, walks and structures are not to exceed 12" and be compacted to 95% density per Modified Proctor Test. In all other areas where construction above the excavation is not anticipated within 2 years, mechanically compact backfill in lifts not exceeding 24" to 90% density per Modified Proctor Test. Route the equipment over each lift of the material so that the compaction equipment contacts all areas of the surface of the lift.

SHEETING, SHORING AND BRACING

Provide shoring, sheet piling and bracing in conformance with the Iowa Administrative Code to prevent earth from caving or washing into the excavation. Shore and underpin to properly support adjacent or adjoining structures. Abandon in place shoring, sheet piling and underpinning below the top of the pipe, or, if approved in advance by the engineer, maintained in place until other permanent support approved by the engineer is provided.

DEWATERING

Provide, operate and maintain all pumps and other equipment necessary to drain and keep all excavation pits, trenches and the entire subgrade area free from water under all circumstances. Obtain general permit for discharge of construction dewatering effluent. Comply with permit requirements.

ROCK EXCAVATION

Remove rock encountered in the excavation to a minimum dimension of six (6) inches outside the pipe. Rock excavation includes all hard, solid rock in ledges, bedded deposits and unstratified masses, all natural conglomerate deposits so firmly cemented as to present all the characteristics of solid rock; which material is so hard or so firmly cemented that in the opinion of the Engineer it is not practical to excavate and remove same with a power shovel except after thorough and continuous drilling and blasting. Rock excavation includes rock boulders of 1/2 cubic yard or more in volume.

Rock excavation will be computed on the basis of the depth of rock removed and a trench width two (2) feet larger than the outside diameter of the pipe where one (1) pipe is laid in the trench and three (3) feet larger than the combined outside diameter where two (2) pipes are laid in the trench. Include 6" pipe and structure bedding in rock excavation. Include rock excavation shown on the plans in the Base Bid.

SURFACE RESTORATION

Completely restore the surface of all disturbed areas to a like condition of the surface prior to the work. Level off all waste disposal areas and clean up all areas used for the storage of materials or the temporary deposit of excavated earth. Remove all surplus material, tools and equipment.

CONCRETE WORK

Cast-in-place concrete within the building will be performed by the Division 3 Contractor unless otherwise noted. Provide all layout drawings, anchor bolts, metal shapes, and/or templates required to be cast into concrete or used to form concrete for support or installation of plumbing piping, fixtures, specialties and equipment. Coordinate locations of equipment, pipe penetrations in wet areas, etc. with the Division 3 Contractor.

CUTTING AND PATCHING

Refer to Division 1, General Requirements, Cutting and Patching.

BUILDING ACCESS

Arrange for the necessary openings in the building to allow for admittance or removal of all apparatus. When the building access was not previously arranged and must be provided by this contractor, restore any opening to its original condition after the apparatus has been brought into the building.

EQUIPMENT ACCESS

Install all piping, conduit and accessories to permit access to equipment for maintenance and service. Coordinate the exact location of wall and ceiling access panels and doors with the General Contractor, making sure that access is available for all equipment and specialties. Access doors in general construction are to be furnished by the Plumbing Contractor and installed by the General Contractor.

Provide color coded thumb tacks or screws, depending on the surface, for use in accessible ceilings which do not require access panels.

COORDINATION

Coordinate all work with other contractors prior to installation. Any work that is not coordinated and that interferes with other contractor's work shall be removed or relocated at the installing contractor's expense.

Verify that all devices are compatible for the type of construction and surfaces on which they will be used.

IDENTIFICATION

See SPS 382.40 for labeling requirements of piping and valves.

Identify equipment in mechanical equipment rooms by stenciling equipment number and service with one coat of black enamel against a light background or white enamel against a dark background. Use a primer where necessary for proper paint adhesion.

Where stenciling is not appropriate for equipment identification, engraved name plates may be used.

Identify interior piping not less than once every 30 feet, not less than once in each room, adjacent to each access door or panel, and on both side of the partition where accessible piping passes through walls or floors. Place flow directional arrows at each pipe identification location. Use one coat of black enamel against a light background or white enamel against a dark background.

Identify all exterior buried piping for entire length with underground warning tape except for sewer piping which is routed in straight lines between manholes or cleanouts. Place tape 6"-12" below finished grade along entire length of pipe. Extend tape to surface at building entrances, meters, hydrants and valves.

Where existing underground warning tape is broken during excavation, replace with new tape identifying appropriate service and securely spliced to ends of existing tape.

Identify valves with brass tags bearing a system identification and a valve sequence number. Valve tags are not required at a terminal device unless the valves are greater than ten feet from the device, located in another room or not visible from device. Provide a typewritten valve schedule and pipe identification schedule indicating the valve number and the equipment or areas supplied by each valve and the symbols used for pipe identification; locate schedules in mechanical room and in each Operating and Maintenance manual. Schedule in mechanical room to be framed under clear plastic.

LUBRICATION

Lubricate all bearings with lubricant as recommended by the manufacturer before the equipment is operated for any reason. Once the equipment has been run, maintain lubrication in accordance with the manufacturer's instructions until the work is accepted by the Owner. Maintain a log of all lubricants used and frequency of lubrication; include this information in the Operating and Maintenance Manuals at the completion of the project.

SLEEVES

Provide galvanized sheet metal sleeves for pipe penetrations through interior and exterior walls to provide a backing for sealant or firestopping. Patch wall around sleeve to match adjacent wall construction and finish. Grout area around sleeve in masonry construction. In finished spaces where pipe penetration through wall is exposed to view, sheet metal sleeve shall be installed flush with face of wall. In existing poured concrete walls where penetration is core drilled, pipe sleeve is not required.

Pipe sleeves are not required in interior non-rated drywall, plaster or wood partitions and sleeves are not required in existing poured concrete walls where penetrations are core drilled.

SEALING AND FIRESTOPPING

FIRE AND/OR SMOKE RATED PENETRATIONS:

Install approved product in accordance with the manufacturer's instructions where a pipe penetrates a fire/smoke rated surface. When pipe is insulated, use a product which maintains the integrity of the insulation and vapor barrier.

Where firestop mortar is used to infill large fire-rated floor openings that could be required to support weight, provide permanent structural forming. Firestop mortar alone is not adequate to support substantial weight.

NON-RATED PARTITIONS:

At all interior partitions and exterior walls, pipe penetrations are required to be sealed. Apply sealant to both sides of the penetration in such a manner that the annular space between the pipe sleeve or cored opening and the pipe or insulation is completely blocked.

END OF SECTION

THIS PAGE INTENTIONALLY LEFT BLANK

SECTION 22 05 14

PLUMBING SPECIALTIES

PART 1 - GENERAL

SCOPE

This section includes specifications for floor drains, roof drains, cleanouts, backflow preventers, water hammer arrestors and other miscellaneous plumbing specialties.

PART 1 - GENERAL

- Scope
- Related Documents
- Reference
- Reference Standards
- Quality Assurance
- Shop Drawings
- Operation and Maintenance Data

PART 2 - PRODUCTS

- Floor Drains
- Roof Drains
- Trench Drains
- Cleanouts
- Water Hammer Arrestors
- Backflow Preventers
- Wall Hydrants
- Hose Bibbs
- Catch Basins
- Safings
- Vent Flashings
- Washing Machine Wall Boxes
- Air Reels
- Water Reels
- Water Make-up for Fire Protection Tank
- High Water alarm for Process sewer tank
- HW Alarm/solenoid
- 6000 gallon Separator
- 2500 Gallon pump tank for process sewer
- Building Water Meter
- ME Garage Area Holding Tank
- ME Autopsy Holding Tank

PART 3 - EXECUTION

- Installation

RELATED DOCUMENTS

- Section 22 11 00 - Facility Water Distribution
- Section 22 13 00 - Facility Sanitary Sewerage
- Section 22 14 00 - Facility Storm Drainage
- Section 22 15 13 - General Service Compressed-Air Piping
- Section 22 05 23 - General-Duty Valves for Plumbing Piping

REFERENCE

Applicable provisions of Division 1 shall govern work under this section.

REFERENCE STANDARDS

- ANSI A112.21.1 - Floor Drains.
- ANSI A112.21.2 - Roof Drains.
- ANSI A112.26.1/PDI WH-201 - Water Hammer Arrestors.
- ASSE 1001 - Pipe Applied Atmospheric Type Vacuum Breakers.
- ASSE 1010 - Water Hammer Arrestors.

ASSE 1011 - Hose Connection Vacuum Breakers.
ASSE 1012 - Backflow Preventers with Intermediate Atmospheric Vent.
ASSE 1013 - Reduced Pressure Principle Backflow Preventers.
ASSE 1019 - Wall Hydrants, Frost Proof Automatic Draining, Anti-Backflow Type.

QUALITY ASSURANCE

Substitution of Materials: Refer to Section GC - General Conditions of the Contract, Equals and Substitutions.

Plumbing products requiring approval by the State of Wisconsin Dept. of Commerce must be approved or have pending approval at the time of shop drawing submission.

SHOP DRAWINGS

Include data concerning dimensions, capacities, materials of construction, ratings, certifications, weights, manufacturer's installation requirements, manufacturer's performance limitations, and appropriate identification.

OPERATION AND MAINTENANCE DATA

All operations and maintenance data shall comply with the submission and content requirements specified under section GENERAL REQUIREMENTS.

PART 2 - PRODUCTS

FLOOR DRAINS

Manufacturer: Smith, Wade, Watts, Zurn.

FD-1: Enameled cast iron two piece body with double drainage flange, weep holes, reversible clamping adjustable collar, adjustable 6" round polished nickel-bronze strainer with threaded collar, bottom outlet.
JR Smith 2005Y-B-M

FD-2: Enameled heavy duty cast iron two piece body with double drainage flange, weep holes, heavy duty adjustable 8 1/2" round coated cast iron tractor grate strainer, with sediment bucket, bottom outlet.
JR Smith 2320Y-B-M

ROOF DRAINS

Manufacturer: Smith, Wade, Watts, Zurn.

RD-1: Bottom outlet roof drain, enameled cast iron body with flashing collar and gravel stop, cast iron dome strainer, adjustable extension, underdeck clamp, 15" diameter.
JR Smith 1015-C-CID

TRENCH DRAINS

Manufacturer: JR Smith or Equal

TD-1: Modular precast polyester trench drain, interlocking sections with presloped 4" wide interior radiused waterways, knockouts, endcaps, ductile iron rail and extra heavy duty (Class F rated) slotted ductile iron grate, grate locking devices.

JR Smith Powerdrain 9877 sloped trench drain w/integral ductile iron frame and Class F ductile iron grates with powerlocking grate locking system, include all end caps, outlets, #9879 channel support/clamping device and accessories.

ABT #2010 Channel with #2513 Ductile Iron Grate and frame with all accessories as needed to meet specifications.

SEE PART 3 for installation items

CLEANOUTS

Manufacturer: Smith, Wade, Watts, Zurn.

UNFINISHED INTERIOR CONCRETE FLOOR AREAS:

Heavy Duty, Enameled cast iron body with round adjustable scoriated cast iron cover, tapered threaded ABS closure plug.
JR Smith 4224S

FINISHED INTERIOR CONCRETE FLOOR AREAS: Enameled cast iron body with round adjustable scoriated polished nickel bronze cover, tapered threaded ABS closure plug.
JR Smith 4024S

INTERIOR FINISHED WALL AREAS: Line type cleanout tee with tapered threaded ABS cleanout plug, round polished stainless steel access cover secured with machine screw.
JR Smith 4530 wall access cover

INTERIOR EXPOSED VERTICAL STACKS: Line type cleanout tee with tapered threaded ABS closure plug.

INTERIOR HORIZONTAL LINES: Cast iron hub with tapped ferrule and tapered threaded ABS or PVC closure plug, or no-hub coupling and blind plug.

EXTERIOR PAVED AREAS: Cast iron hub or plug with tapered threaded ABS or PVC closure plug, cast iron frost sleeve and cover set in 24" square by 4" min. thick reinforced concrete pad top or surrounding pavement, crowned for drainage. SR Smith 4253S or Neenah R-1976 with non-ferrous securing screw.

EXTERIOR UNPAVED AREAS: Cast iron hub or plug with tapered threaded ABS or PVC closure plug, cast iron or PVC frost sleeve and cover set in 24" square by 4" min. thick reinforced concrete pad top. JR Smith 4253S or Neenah R-1976 with non-ferrous securing screw.

WATER HAMMER ARRESTORS

Manufacturer: JR Smith, PPP Industries, Sioux Chief, Wade, Watts.

ANSI A112.26.1, ASSE 1010; sized in accordance with PDI WH-201, precharged piston type constructed of hard drawn Type K copper, threaded brass adapter, brass piston with o-ring seals, FDA approved silicone lubricant, suitable for operation in temperature range 35 to 150 degrees F, maximum 250 psig working pressure, 1500 psig surge pressure. JR Smith 5200 Series or Watts series 15.

BACKFLOW PREVENTERS

Manufacturers: Beeco, Cla-Val, Conbraco, Febco, Watts, Wilkins.

HOSE CONNECTION VACUUM BREAKERS: ASSE 1011, brass or bronze construction, EPDM diaphragm and seat, rated for 125 psig and 180°F. Watts 8 (interior application).

PIPE APPLIED ATMOSPHERIC TYPE VACUUM BREAKERS: ASSE 1001, same size as pipe, brass or bronze construction, silicone disc, rated for 125 psig and 160°F. Watts 288A.

HIGH HAZARD ANTI-SIPHON, ANTI-SPILL VACUUM BREAKERS: ASSE 1056, same size as pipe, brass or bronze construction, silicone rubber discs, stainless steel springs, inlet and outlet ball shutoff valves, with test cocks, anti-spill design, rated for 150 psig and 180 deg. F max.. Watts 008QT.

DUAL CHECK WITH ATMOSPHERIC VENT: 3/8", stainless steel body and parts, dual check with third ball check outlet, rated for 150 psig and 140°F.
Watts SD3.

INTERMEDIATE ATMOSPHERIC VENTED BACKFLOW PREVENTERS: ASSE 1012, same size as pipe, with intermediate atmospheric vent between independent check valves, bronze body with union ends, stainless steel springs, rated for 175 psig and 210°F. Watts 9DM.

REDUCED PRESSURE ZONE BACKFLOW PREVENTERS: ASSE 1013 reduced pressure zone backflow assembly complete with inlet strainer, inlet and outlet ball or non-rising stem gate isolation valves.. Constructed of bronze or epoxy coated cast iron body with bronze and plastic internal parts, stainless steel springs, non-threaded vent outlet, 4 test cocks, rated for 175 psig and 210°F, with air gap apparatus on drain. Watts series 009 or 909 series products.

WALL HYDRANTS

Manufacturer: Woodford.

WH-1: Freezeproof automatic draining wall hydrant with exposed chrome plated bronze wall plate, 3/4" inlet, 3/4" hose thread ASSE 1019-93 backflow preventer outlet, copper or bronze casing, loose key operator. Woodford model 67 series

HOSE BIBBS

HB-1: Bronze or brass construction hose faucet/valve, cast iron handwheel, replaceable disc, hose thread spout, with ASSE 1011 backflow preventer outlet, 3/4" size.
Woodford #24.

CATCH BASINS

Garage Catch Basin #1 & #2

Shall be 36" diameter inside diameter by 6' deep reinforced precast concrete (or Fiberglass) with proper inlet/outlet openings.

6" thick concrete base, if applicable.

Backfill shall be gravel or sand compacted.

Frame and grate shall be heavy duty.

See plan for elevations.

SAFINGS

Manufacturers: Noble, Oatey.

Chlorinated polyethylene sheeting, 40 mils thick, ASTM D4068, joined with CPE solvent;

VENT FLASHINGS

Manufacturers: Semco, Oatey.

Single Ply Membrane Roofs: Flashing boot of material compatible with roofing membrane with base flange for adhering to membrane and stainless steel drawband for securing to vent pipe.

WASHING MACHINE WALL BOXES

AWC-1: recessed wall box with face flange, overflow lip, fastening tabs, 1/2" hot and cold bronze washing machine ¼ turn shutoff valves rated for 125 psi and 180 degrees F, long shank valve fittings for replacement of valves within box, 2" drain outlet fitting.

Symmons W-602

Screw on shock stops with hose thread connections

AIR REELS, AR1 & AR2

Description: Low Pressure air reel, heavy duty, all steel construction, spring driven,

2 sealed bearings at main shaft, dual pedestal base and guide arms,

75' of ½" hose, baked-on powder coat finish

Fixture: Reelcraft 82075 OLP

Flex hose: SS braided shell, synthetic rubber inner hose, brass connectors

WATER REELS, WR1

Description: Low Pressure water reel, heavy duty, all steel construction, spring driven, 2 Sealed

bearings at main shaft, dual pedestal base and guide arms, 50' of 1" hose,

baked-on powder coat finish.

Fixture: Reelcraft D84050 OLP

Flex hose: SS braided shell, synthetic rubber inner hose, brass connectors

Backflow preventer: Watts 1" 008PCQT (ASSE 1056) vacuum breaker.

1" aluminum Nozzle, Kochek # NZ030 (FireHose Direct)

Thread Adaptor, Grainger 6ANXO, 1"NTP male to 1"NPSH male adaptor.

1"NTP brass coupler.

WATER MAKE-UP FOR FIRE PROTECTION TANK

Level sensor – SJE Rhombus Float switch SPDT, 30' normally closed (closes when level drops)

Slow closing solenoid valve – ASCO 2", normally closed, Model 8221, 120V

2" water meter – Badger Recordall 2" disc meter

HW ALARM/SOLENOID (near HW storage tank on mezzanine)

Symmons HTA-100 with SV-1000 2" solenoid valve.
Set at alarm at 130F

6000 GALLON OIL/GRIT SEPERATOR

Exterior Buried Reinforced precast concrete assembly for separation of oil/grease/grit.
Manhole covers & tank top shall be capable of withstanding Semi truck loading.
6000 gallon 5000 psi precast concrete unit with manholes as needed to inspect & clean tank compartments, manhole risers, riser rings, CI heavy duty frame/solid lids, baffles/drop pipes as needed , joints sealed with Mastic sealant, 6"pipe size.

5000 GALLON PUMP TANK FOR PROCESS SEWER

Exterior Buried Reinforced precast concrete assembly.
Manhole covers & tank top shall be capable of withstanding Semi truck loading.
5000 gallon 5000 psi precast concrete unit with manholes as needed to inspect & clean tank compartments, manhole risers, riser rings, CI heavy duty frame/solid lid, joints sealed with Mastic sealant, 6"pipe size.
SJE-Rhombus, SJE Level Monitor CL100 with Alarm for remote installation (200')

BUILDING WATER METER

2" water meter – Badger Recordall 2" disc meter.

ME GARAGE AREA, HOLDING TANK

Exterior Buried Reinforced precast concrete assembly for separation of oil/grease/grit.
Manhole covers & tank top shall be capable of withstanding Semi truck loading.
2500 gallon 5000 psi precast concrete unit with manholes as needed to inspect & clean tank compartments, manhole risers, riser rings, CI heavy duty frame/solid lids, warning labels, joints sealed with Mastic sealant, 4"pipe size.
SJE-Rhombus, SJE Level Monitor CL100with Alarm for remote installation (200')

ME AUTOPSY, HOLDING TANK

Exterior Buried Reinforced precast concrete assembly.
Manhole covers & tank top shall be capable of withstanding Semi truck loading.
7500 gallon 5000 psi precast concrete unit with manholes as needed to inspect & clean tank compartments, manhole risers, riser rings, Lockable CI heavy duty frame/solid lids, warning labels, joints sealed with Mastic sealant, 4"pipe size.
SJE-Rhombus, SJE Level Monitor CL100with Alarm for remote installation (200')

PART 3 - EXECUTION

INSTALLATION

Coordinate location and setting of plumbing specialties with adjacent construction. Install in accordance with manufacturers recommendations.

Set floor drains, roof drains, trench drains and cleanouts level and plumb adjusted to finished floor elevation, roof elevation or finished wall location. Locate where serviceable. Allow minimum of 18" clearance around cleanouts for rodding. Lubricate threaded cleanout plugs with graphite and oil, teflon tape or waterproof grease. Provide deep seal traps on floor drains.

Installation of Holding Tank Level Controls/Alarm for 3 holding tanks shall conform to MFG installation guide.

Include all miscellaneous items for installation. Set and adjust Equipment per Mfg installation guide. Provide signage indicating tank served.

Install water hammer arrestors where indicated and at quick closing valve installations.

Install backflow preventers in accordance with Wisconsin Code requirements maintaining minimum clearance distances for servicing and testing. Provide indirect waste piping with air gap installation from relief opening to above hub drain or floor drain.

Where backflow preventers requiring Code registration are installed, provide initial registration, testing and report filing required by the WI-DSPS. Follow all Code Requirements. Include app paperwork in Owners manuals.

Mount wall hydrants recessed in exterior wall construction with valve plug extended beyond interior side of building insulation. Slope to drain to exterior. Install so discharge is 18" min. above finished grade. Set in grout or caulk and fill exterior wall penetration with insulation.

Mount hose bibbs securely fastened to wall where indicated. Provide water hammer arrestor in line to hose bibb.

Excavate for catch basins setting precast bases on granular backfill and pouring cast in place bases on undisturbed soil. Seal joints between base, sections, collars and castings with gasketing material for tightly packed waterproof seals. Adjust casting to match finished grade. Form interior shelves with concrete grout for smooth flowlines conforming to the shape and slope of the sewer. Place piping into manholes providing full support of piping on exterior bedding and insuring pipe seals are properly installed and waterproof. Structures intended to remain dry must be made waterproof and are subject to infiltration testing. Backfill and compact soil around manhole or catch basin.

Excavate for Large oil/grit separator, pump tank, Holding tanks (3) and wash bay water reclaim separator tanks (5) setting precast base on granular backfill bases with undisturbed soil below. Seal joints between base, sections, collars and castings with gasketing material for tightly packed waterproof seals. Adjust casting to match finished grade. Place piping into manholes providing full support of piping on exterior bedding and insuring pipe seals are properly installed and waterproof. Structures intended to remain dry must be made waterproof and are subject to infiltration testing, Backfill and compact soil around underground structure.

Install safing at floor drains above grade. Extend 12" beyond drains in all directions Install on concrete floor that is smooth and free of debris. Seal all joints and connect to drain body clamp. Safing is subject to standing water leak test. Install safing at all built-up shower installations. (Note: spray-on and brush applied liquid safing is not acceptable).

Flash vent penetrations through roof. Co-ordinate installation of pipe and roof boot with roof installer, Tighten drawband of membrane boot to vent pipe. Adhere base flashing to deck or membrane.

Install washing machine boxes in wall construction, secured to structure, directly behind proposed washing machine location. Provide water hammer arrestors in supply piping. Mount box a min. of 36" above floor.

TRENCH DRAIN INSTALLATION

See Mfg instructions for installation, include all required concrete bedding materials, supports, staking to secure trench drain during concrete installation, co-ordination with other trades as needed.

WATER MAKE-UP FOR FIRE PROTECTION TANK

Level sensor – SJE Rhombus Float switch SPDT, 30' normally closed (closes when level drops)
Slow closing solenoid valve – ASCO 2", normally closed, Model 8221, 120V
2" water meter – Badger Recordall 2" disc meter

BACKFLOW PREVENTERS

Install units, test and register with WI-DSPS

END OF SECTION

SECTION 22 05 29
HANGERS AND SUPPORTS FOR PLUMBING PIPING AND EQUIPMENT

PART 1 - GENERAL

SCOPE

This section includes specifications for supports of all plumbing equipment and materials as well as piping system anchors. Included are the following topics:

PART 1 - GENERAL

- Scope
- Related Work
- Reference
- Reference Standards
- Quality Assurance
- Description
- Shop Drawings
- Design Criteria

PART 2 - PRODUCTS

- Manufacturers
- Structural Supports
- Pipe Hangers and Supports
- Beam Clamps
- Riser Clamps
- Concrete Inserts
- Equipment Stands
- Corrosive Atmosphere Coatings

PART 3 - EXECUTION

- Installation
- Hanger and Support Spacing
- Riser Clamps
- Concrete Inserts

RELATED WORK

Section 22 07 00 - Plumbing Insulation for insulation protection at support devices.

REFERENCE

Applicable provisions of Division 1 shall govern work under this section.

REFERENCE STANDARDS

MSS SP-58
MSS SP-69

REFERENCE

Applicable provisions of Division 1 govern work under this section.

QUALITY ASSURANCE

Substitution of Materials: Refer to Section GC - General Conditions of the Contract, Equals and Substitutions.

DESCRIPTION

Provide all supporting devices as required for the installation of mechanical equipment and materials. All supports and installation procedures are to conform to the latest requirements of the ANSI Code for building piping.

Do not hang any mechanical item directly from a metal deck or run piping so its rests on the bottom chord of any truss or joist.

Fasteners depending on soft lead for holding power or requiring powder actuation will not be accepted.

Support apparatus and material under all conditions of operation, variations in installed and operating weight of equipment and piping, to prevent excess stress, and allow for proper expansion and contraction.

Protect insulation at all hanger points; see Related Work above.

SHOP DRAWINGS

Schedule of all hanger and support devices indicating attachment methods and type of device for each pipe size and type of service.

All submittals are to comply with submission and content requirements specified with in section 17 00 00.

DESIGN CRITERIA

Materials and application of pipe hangers and supports shall be in accordance with MSS Standard Practice SP-58 and SP-69 unless noted otherwise.

Piping connected to pumps, compressors, or other rotating or reciprocating equipment is to have vibration isolation supports for a distance of one hundred pipe diameters or three supports away from the equipment, whichever is greater. Standard pipe hangers/supports as specified in this section are required beyond the 100 pipe diameter/3 support distance.

PART 2 - PRODUCTS

MANUFACTURERS

Anvil, B-Line, Pate, Piping Technology, Roof Products & Systems or approved equal.

STRUCTURAL SUPPORTS

Provide all supporting steel required for the installation of mechanical equipment and materials, including angles, channels, beams, etc. to suspended or floor supported tanks and equipment. All of this steel may not be specifically indicated on the drawings.

PIPE HANGERS AND SUPPORTS

HANGERS FOR PIPE SIZES 1/2" THROUGH 2":

Carbon steel, adjustable swivel ring. B-Line B3170NF, Anvil 69 or 70.

Carbon steel, adjustable clevis, standard. B-Line B3100, Anvil 260.

HANGERS FOR PIPE SIZES 2" AND LARGER:

Carbon steel, adjustable clevis, standard. B-Line B3100, Anvil 260.

MULTIPLE OR TRAPEZE HANGERS:

Steel channels with welded spacers and hanger rods.

WALL SUPPORT:

Carbon steel welded bracket with hanger. B-Line 3068 Series, Anvil 194 Series.

Perforated, epoxy painted finish, 16-12 gauge, min., steel channels securely anchored to wall structure, with interlocking, split-type, bolt secured, galvanized pipe/tubing clamps. B-Line type S channel with B-2000 series clamps, Anvil type PS 200 H with PS 1200 clamps. When copper piping is being supported, provide flexible elastomeric/thermoplastic isolation cushion material to completely encircle the piping and avoid contact with the channel or clamp, equal to B-Line B1999 Vibra Cushion or provide manufacturers clamp and cushion assemblies, B-Line BVT series, Anvil PS 1400 series.

VERTICAL SUPPORT:

Carbon steel riser clamp. B-Line B3373, Anvil 261 for above floor use.

FLOOR SUPPORT:

Carbon steel pipe saddle, stand and bolted floor flange. B-Line B3088T/B3093.

COPPER PIPE SUPPORTS:

All supports, fasteners, clamps, etc. directly connected to copper piping shall be copper plated or polyvinylchloride coated. Where steel channels are used, provide isolation collar between supports/clamps/fasteners and copper piping.

PIPE HANGER RODS

STEEL HANGER RODS:

Threaded both ends, threaded one end, or continuous threaded, complete with adjusting and lock nuts.

Size rods for individual hangers and trapeze support as indicated in the following schedule.

Total weight of equipment, including valves, fittings, pipe, pipe content, and insulation, are not to exceed the limits indicated.

Maximum Load (Lbs.) <u>(650°F Maximum Temp.)</u>	Rod Diameter <u>(inches)</u>
610	3/8
1130	1/2
1810	5/8
2710	3/4
3770	7/8
4960	1
8000	1-1/4

BEAM CLAMPS

MSS SP-69 Types 19 & 23 malleable black iron clamp for attachment to beam flange to 0.62 inches thick with a retaining ring and threaded rod of 3/8, 1/2, and 5/8 inch diameter. Furnish with a hardened steel cup point set screw. B-Line B3036L/B3034, Anvil 86/92.

MSS SP-69 Type 28 or Type 29 forged steel jaw type clamp with a tie rod to lock clamp in place, suitable for rod sizes to 1-1/2 inch diameter. B-Line B3054, Anvil 228.

CONCRETE INSERTS

DRILLED FASTENERS:

Carbon steel expansion anchors, vibration resistant, with ASTM B633 zinc plating. Use drill bit of same manufacturer as anchor. Hilti, Rawl, Redhead.

EQUIPMENT STANDS

Use structural steel members welded to and supported by pipe supports. Clean, prime and coat with three coat rust inhibiting alkyd paint or one coat epoxy mastic. Where exposed to weather, treat with corrosive atmosphere coatings.

CORROSIVE ATMOSPHERE COATINGS

Factory coat supports and anchors used in corrosive atmospheres with hot dip galvanizing after fabrication, ASTM A123, 1.5 ounces/square foot of surface each side. Mechanical galvanize threaded products, ASTM B695 Class 50, 2.0 mil coating. Field cuts and damaged finishes to be field covered with zinc rich paint of comparable thickness to factory coating.

Corrosive atmospheres include the following locations:

- Manual Wash

PART 3 - EXECUTION

INSTALLATION

Size, apply and install supports and anchors in compliance with manufacturers recommendations.

Install supports to provide for free expansion of the piping system. Support all piping from the structure using concrete inserts, beam clamps, ceiling plates, wall brackets, or floor stands. Fasten ceiling plates and wall brackets securely to the structure and test to demonstrate the adequacy of the fastening.

Coordinate hanger and support installation to properly group piping of all trades.

Where piping can be conveniently grouped to allow the use of trapeze type supports, use standard structural shapes or continuous insert channels for the supporting steel. Where continuous insert channels are used, pipe supporting devices made specifically for use with the channels may be substituted for the specified supporting devices provided that similar types are used and all data is submitted for prior approval.

Size and install hangers and supports, except for riser clamps, for installation on the exterior of piping insulation. Where a vapor barrier is not required, hangers may be installed either on the exterior of pipe insulation or directly on piping.

Perform welding in accordance with standards of the American Welding Society.

HANGER AND SUPPORT SPACING

Install hangers to provide minimum 1/2 inch space between finished covering and adjacent work.

Place a hanger within 12 inches of each horizontal elbow, valve, strainer, or similar piping specialty item.

Use hangers with 1-1/2 inch minimum vertical adjustment.

Where several pipes can be installed in parallel and at the same elevation, provide multiple or trapeze hangers.

Support riser piping independently of connected horizontal piping.

Adjust hangers to obtain the slope specified in the piping section of these specifications.

Space hangers for pipe as follows:

<u>Pipe Material</u>	<u>Pipe Size</u>	<u>Max. Horiz. Spacing</u>	<u>Max. Vert. Spacing</u>
Cast Iron	2" and larger	5'-0"	15'-0"
Copper	1/2" through 3/4"	5'-0"	10'-0"
Copper	1" through 1-1/4"	6'-0"	10'-0"
Copper	1-1/2" through 2-1/2"	8'-0"	10'-0"
Copper	3"	10'-0"	10'-0"
Copper	4" and larger	12'-0"	10'-0"
Steel	1/2" through 1-1/4"	7'-0"	15'-0"
Steel	1-1/2" through 6"	10'-0"	15'-0"
Steel	8" through 12"	14'-0"	20'-0"
Plastic	Drain and Vent	4'-0"	10'-0"

RISER CLAMPS

Support vertical piping with clamps secured to the piping and resting on the building structure or secured to the building structure below at each floor.

CONCRETE INSERTS

Select size based on the manufacturer's stated load capacity and weight of material that will be supported. Use inserts for suspending hangers from reinforced concrete slabs and sides of reinforced concrete beams. Where concrete slabs form finished ceiling, provide inserts that are flush with the slab surface.

END OF SECTION

THIS PAGE INTENTIONALLY LEFT BLANK

**SECTION 22 13 00
FACILITY SANITARY SEWERAGE**

PART 1 - GENERAL

SCOPE

This section contains specifications for plumbing pipe and pipe fittings for this project. Included are the following topics:

PART 1 - GENERAL

- Scope
- Reference
- Reference Standards
- Shop Drawings
- Quality Assurance
- Delivery, Storage, and Handling
- Design Criteria

PART 2 - PRODUCTS

- Sanitary Waste and Vent

PART 3 - EXECUTION

- General
- Preparation
- Erection
- Threaded Pipe Joints
- Solvent Welded Pipe Joints
- Mechanical Hubless Pipe Connections
- Sanitary Waste and Vent
- Piping System Leak Tests

RELATED WORK

22 05 29 - Hangers and Supports for Plumbing Piping and Equipment

22 05 14 - Plumbing Specialties

REFERENCE

Applicable provisions of Division 1 govern work under this section.

REFERENCE STANDARDS

ANSI B16.5	Pipe Flanges and Flanged Fittings
ASTM A74	Cast Iron Soil Pipe and Fittings
ASTM A888	Hubless Cast Iron Soil Pipe and Fittings for Sanitary and Storm Drain, Waste, and Vent Piping Applications
ASTM C564	Standard Specifications for Rubber Gaskets for Cast Iron Soil Pipe and Fittings
ASTM C1540	Standard Specifications for Heavy Duty Shielded Couplings Joining Hubless Cast Iron Soil Pipe and Fittings
ASTM D1785	Poly Vinyl Chloride (PVC) Plastic Pipe
ASTM D2466	Poly Vinyl Chloride (PVC) Plastic Pipe Fittings, Schedule 40
ASTM D2564	Solvent Cements for Poly Vinyl Chloride (PVC) Plastic Pipe and Fittings
ASTM D2665	Poly Vinyl Chloride (PVC) Plastic Drain, Waste and Vent Pipe and Fittings
ASTM D2729	Poly Vinyl Chloride (PVC) Sewer Pipe and Fittings
ASTM D2855	Making Solvent Cemented Joints with Poly Vinyl Chloride (PVC) Pipe and Fittings
ASTM D3311	Drain, Waste and Vent (DWV) Plastic Fitting Patterns
CISPI 301	Hubless Cast Iron Soil Pipe and Fittings for Sanitary and Storm Drain, Waste and Vent Piping Applications

CISPI 310 Couplings For Use In Connection With Hubless Cast Iron Soil Pipe And Fittings For Sanitary And Storm Drain, Waste And Vent Piping Applications

SHOP DRAWINGS

Schedule from the contractor indicating the ASTM, or CISPI specification number of the pipe being proposed along with its type and grade if known at the time of submittal, and sufficient information to indicate the type and rating of fittings for each service.

Statement from manufacturer on his letterhead that pipe furnished meets the ASTM, or CISPI specification contained in this section.

QUALITY ASSURANCE

Substitution of Materials: Refer to Section GC – General Conditions of the Contract, Equals and Substitutions.

Order all pipe with each length marked with the name or trademark of the manufacturer and type of pipe; with each shipping unit marked with the purchase order number, metal or alloy designation, temper, size, and name of supplier.

Any installed material not meeting the specification requirements must be replaced with material that meets these specifications without additional cost to the Owner.

DELIVERY, STORAGE, AND HANDLING

Promptly inspect shipments to insure that the material is undamaged and complies with specifications.

Cover pipe to prevent corrosion or deterioration while allowing sufficient ventilation to avoid condensation. Do not store materials directly on grade. Protect pipe, tube, and fitting ends so they are not damaged. Where end caps are provided or specified, take precautions so the caps remain in place. Protect fittings, flanges, and unions by storage inside or by durable, waterproof, above ground packaging.

Offsite storage agreements will not relieve the contractor from using proper storage techniques.

Storage and protection methods must allow inspection to verify products.

DESIGN CRITERIA

Use only new material, free of defects, rust and scale, and meeting the latest revision of ASTM, or CISPI specifications as listed in this specification.

Construct all piping for the highest pressures and temperatures in the respective system.

Non-metallic piping will be acceptable only for the services indicated. It will not be acceptable in ventilation plenum spaces, including plenum ceilings.

PART 2 - PRODUCTS

SANITARY/PROCESS WASTE AND VENT

INTERIOR ABOVE GROUND:

Hubless cast iron soil pipe and fittings with no-hub couplings, ASTM A888, CISPI 301, ASTM A74.

PVC plastic pipe
Schedule 40, Class 12454-B (PVC 1120), ASTM D1785; PVC plastic drain, waste and vent pipe and fittings, ASTM D2665; socket fitting patterns, ASTM D3311; primer (Lo-VOC), ASTM F656; solvent cement (Lo-VOC), ASTM D2564.

INTERIOR BELOW GROUND:

Hubless cast iron soil pipe and fittings with no-hub couplings, ASTM A888, CISPI 301, ASTM A74.

PVC plastic pipe, Schedule 40, Class 12454-B (PVC 1120), ASTM D1785; PVC plastic drain, waste and vent pipe and fittings, ASTM D2665; socket fitting patterns, ASTM D3311; primer, ASTM F656; solvent cement, ASTM D2564.

EXTERIOR BELOW GROUND 6" AND SMALLER:

Cast iron soil pipe and fittings, CISPI 301, ASTM A74 or ASTM A888 with neoprene rubber compression gaskets, ASTM C564 and CISPI HSN 85. Pipe and fittings shall be marked with the collective trademark of the Cast Iron Pipe Institute.

PVC plastic pipe, Schedule 40, Class 12454-B (PVC 1120), ASTM D1785; PVC plastic drain, waste and vent pipe and fittings, ASTM D2665; socket fitting patterns, ASTM D3311; primer, ASTM F656; solvent cement, ASTM D2564.

PART 3 - EXECUTION

GENERAL

Install pipe and fittings in accordance with reference standards, manufacturers recommendations and recognized industry practices.

PREPARATION

Cut pipe ends square. Ream ends of piping to remove burrs. Clean scale and dirt from interior and exterior of each section of pipe and fitting prior to assembly.

ERECTION

Install all piping parallel to building walls and ceilings and at heights which do not obstruct any portion of a window, doorway, stairway, or passageway. Where interferences develop in the field, offset or reroute piping as required to clear such interferences. Coordinate locations of plumbing piping with piping, ductwork, conduit and equipment of other trades to allow sufficient clearances. In all cases, consult drawings for exact location of pipe spaces, ceiling heights, door and window openings, or other architectural details before installing piping.

Install underground warning tape 6"-12" below finished grade above all exterior below ground piping. Where existing underground warning tape is encountered, repair and replace.

Maintain piping in clean condition internally during construction.

Provide clearance for installation of insulation, access to valves and piping specialties.

Provide anchors, expansion joints, swing joints and/or expansion loops so that piping may expand and contract without damage to itself, equipment, or building.

Do not route piping through transformer vaults or above transformers, panelboards, or switchboards, including the required service space for this equipment, unless the piping is serving this equipment

SOLVENT WELDED PIPE JOINTS

Install in accordance with ASTM D2855 "Making Solvent Cemented Joints with PVC Pipe and Fittings". Saw cut piping square and smooth. Tube cutters may be used if they are fitted with wheels designed for use with PVC pipe that do not leave a raised bead on pipe exterior. Support and restrain pipe during cutting to prevent nicks and scratches. Bevel ends 10-15 degrees and deburr interior. Remove dust, drips, moisture, grease and other superfluous materials from pipe interior and exterior. Check dry fit of pipe and fittings. Reject materials which are out of round or do not fit within close tolerance. Use heavy body solvent cement for large diameter fittings.

Maintain pipe, fittings, primer and cement between 40 and 100 degrees during application and curing. Apply primer and solvent using separate daubers (3" and smaller piping only) or clean natural bristle brushes about 1/2 the size of the pipe diameter. Apply primer to the fitting socket and pipe surface with a scrubbing motion. Check for penetration and reapply as needed to dissolve surface to a depth of 4-5 thousandths. Apply solvent cement to the fitting socket and pipe in an amount greater than needed to fill any gap. While both surfaces are wet, insert pipe into socket fitting with a quarter turn to the bottom of the socket. Solvent cement application and insertion must be completed in less than 1 minute. Minimum of 2 installers is required on piping 4" and larger. Hold joint for 30 seconds or until set. Reference manufacturers recommendations for initial set time before handling and for full curing time before pressure testing. Cold weather solvent/cement may be utilized only under unusual circumstances and when specifically approved by the Project Representative.

MECHANICAL HUBLESS PIPE CONNECTIONS

Place the gasket on the end of one pipe or fitting and the clamp assembly on the end of the other pipe or fitting. Firmly seat the pipe or fitting ends against the integrally molded shoulder inside the neoprene gasket. Slide the clamp assembly into position over the gasket. Tighten fasteners to manufacturers recommended torque.

SANITARY WASTE AND VENT

Verify invert elevations and building elevations prior to installation. Install exterior piping pitched to drain at indicated elevations and slope. Install interior piping pitched to drain at minimum slope of 1/4" per foot where possible and in no case less than 1/8" per foot for piping 3" and larger.

Install exterior piping below predicted frost level and not less than 5' bury depth to top of pipe wherever possible.

Flush piping inlets (floor drains, hub drains, mop basins, fixtures, etc.) with high flow of water at completion of project to demonstrate full flow capacity. Remove blockages and make necessary repairs where flow is found to be impeded.

PIPING SYSTEM LEAK TESTS

Isolate or remove components from system which are not rated for test pressure. Perform final testing for medical and lab gas with all system components in place. Test piping in sections or entire system as required by sequence of construction. Do not insulate or conceal pipe until it has been successfully tested.

If required for the additional pressure load under test, provide temporary restraints at fittings or expansion joints.

For hydrostatic tests, use clean water and remove all air from the piping being tested by means of air vents or loosening of flanges/unions. Measure and record test pressure at the high point in the system.

For air or nitrogen tests, gradually increase the pressure to not more than one half of the test pressure; then increase the pressure in steps of approximately one-tenth of the test pressure until the required test pressure is reached. Examine all joints and connections with a soap bubble solution or equivalent method. System will not be approved until it can be demonstrated that there is no measurable loss of test pressure during the test period.

Inspect system for leaks. Where leaks occur, repair the area with new materials and repeat the test; caulking will not be acceptable.

Entire test must be witnessed by the Owner's representative. All pressure tests are to be documented on forms to be provided to the contractor.

<u>System</u>	<u>Test Medium</u>	<u>Initial Test</u>		<u>Final Test</u>	
		<u>Pressure</u>	<u>Duration</u>	<u>Pressure</u>	<u>Duration</u>
Sanitary/Process Waste and Vent	Water	N/A		10' water	2 hr

END OF SECTION

PIPING SYSTEM TEST REPORT

Date Submitted: _____

Project Name: _____

Location: _____ **Project No.:** _____

Contractor: _____

Plumbing

Test Medium: Air Water Other _____

Test performed per specification Section No. _____

Specified Test Duration _____ Hours Specified Test Pressure _____ PSIG

System Identification: _____

Describe Location: _____

Test Date: _____	
Start Test Time: _____	Initial Pressure: _____ PSIG
Stop Test Time: _____	Final Pressure: _____ PSIG

Tested By: _____

Witnessed By: _____

Title: _____

Title: _____

Signed: _____

Signed: _____

Date: _____

Date: _____

Comments: _____

**SECTION 23 05 00
COMMON WORK RESULTS FOR HVAC**

PART 1 - GENERAL

SCOPE

This section includes information common to two or more technical specification sections or items that are of a general nature, not conveniently fitting into other technical sections. Included are the following topics:

PART 1 - GENERAL

- Scope
- Related Work
- Reference
- Reference Standards
- Quality Assurance
- Continuity of Existing Services
- Protection of Finished Surfaces
- Sleeves and Openings
- Sealing and Firestopping
- Submittals
- Off Site Storage
- Request and Certification for Payment
- Certificates and Inspections
- Operating and Maintenance Instructions
- Training of Owner Personnel
- Record Drawings

PART 2 - PRODUCTS

- Access Panels and Doors
- Identification
- Sealing and Firestopping

PART 3 - EXECUTION

- Demolition
- Excavation and Backfill
- Concrete Work
- Cutting and Patching
- Building Access
- Equipment Access
- Coordination
- Identification
- Lubrication
- Sleeves
- Sealing and Firestopping

RELATED WORK

Section 23 05 13 - Common Motor Requirements for HVAC.
Section 23 33 00 - Air Duct Accessories.

REFERENCE

Applicable provisions of Division 1 govern work under this section.

REFERENCE STANDARDS

Abbreviations of standards organizations referenced in other sections are as follows:

AABC	Associated Air Balance Council
ABMA	American Boiler Manufacturers Association
ADC	Air Diffusion Council
AGA	American Gas Association
AMCA	Air Movement and Control Association
ANSI	American National Standards Institute
ARI	Air-Conditioning and Refrigeration Institute
ASHRAE	American Society of Heating, Refrigerating and Air Conditioning Engineers
ASME	American Society of Mechanical Engineers
ASTM	American Society for Testing and Materials

AWWA	American Water Works Association
AWS	American Welding Society
EPA	Environmental Protection Agency
GAMA	Gas Appliance Manufacturers Association
IEEE	Institute of Electrical and Electronics Engineers
ISA	Instrument Society of America
MCA	Mechanical Contractors Association
MICA	Midwest Insulation Contractors Association
MSS	Manufacturer's Standardization Society of the Valve & Fitting Industry, Inc.
NBS	National Bureau of Standards
NEBB	National Environmental Balancing Bureau
NEC	National Electric Code
NEMA	National Electrical Manufacturers Association
NFPA	National Fire Protection Association
SMACNA	Sheet Metal and Air Conditioning Contractors' National Association. Inc.
UL	Underwriters Laboratories Inc.
ASTM E814	Standard Test Method for Fire Tests of Through-Penetration Fire Stops
ASTM E84	Standard Test Method for Surface Burning Characteristics of Building Materials
UL1479	Fire Tests of Through-Penetration Firestops
UL723	Surface Burning Characteristics of Building Materials

QUALITY ASSURANCE

Refer to Division 1, General Conditions, Equals and Substitutions.

Where equipment or accessories are used which differ in arrangement, configuration, dimensions, ratings, or engineering parameters from those indicated on the contract documents, the contractor is responsible for all costs involved in integrating the equipment or accessories into the system and for obtaining the performance from the system into which these items are placed. This may include changes found necessary during the testing, adjusting, and balancing phase of the project.

CONTINUITY OF EXISTING SERVICES

Do not interrupt or change existing services without prior written approval from the A/E or Owner. When interruption is required, coordinate the down-time with the user agency to minimize disruption to their activities. Unless specifically stated, all work involved in interrupting or changing existing services is to be done during normal working hours.

PROTECTION OF FINISHED SURFACES

Refer to Division 1, General Requirements, Protection of Finished Surfaces.

Furnish one can of touch-up paint for each different color factory finish which is to be the final finished surface of the product. Deliver touch-up paint with other "loose and detachable parts" as covered in the General Requirements.

SLEEVES AND OPENINGS

Refer to Division 1, General Requirements, Sleeves and Openings.

SEALING AND FIRESTOPPING

Sealing and firestopping of sleeves/openings between ductwork, piping, etc. and the sleeve, structural or partition opening shall be the responsibility of the contractor whose work penetrates the opening. The contractor responsible shall hire individuals skilled in such work to do the sealing and fireproofing. These individuals hired shall normally and routinely be employed in the sealing and fireproofing occupation.

SUBMITTALS

Refer to Division 1, General Conditions, Submittals.

Submit for all equipment and systems as indicated in the respective specification sections, marking each submittal with that specification section number. Mark general catalog sheets and drawings to indicate specific items being submitted and proper identification of equipment by name and/or number, as indicated in the contract documents.

Before submitting electrically powered equipment, verify that the electrical power and control requirements for the equipment are in agreement with the motor starter schedule on the electrical

drawings. Include a statement on the shop drawing transmittal to the architect/engineer that the equipment submitted and the motor starter schedule are in agreement or indicate any discrepancies. See related comments in Section 23 05 13 in Part 1 under Electrical Coordination.

Include wiring diagrams of electrically powered equipment.

Submit sufficient quantities of shop drawings to allow the following distribution:

- Operating and Maintenance Manuals 2 copies
- Testing, Adjusting and Balancing Contractor 1 copy
- A/E 1 copy

OFF SITE STORAGE

Ductwork, metal for making ductwork, duct lining, sleeves, pipe/pipe fittings and similar rough-in material will not be accepted for off site storage. For material that can be stored off site, no material will be accepted for off site storage unless shop drawings for that material have been approved.

REQUEST AND CERTIFICATION FOR PAYMENT

Refer to general conditions for payment requirements.

CERTIFICATES AND INSPECTIONS

Refer also to Division 1, General Conditions, Permits, Regulations, Utilities and Taxes.

Obtain and pay for all required State installation inspections except those provided by the Architect/Engineer in accordance with Wis Adm Code Section ILHR 50.12 and Wisconsin Department of Health Services. Include copies of the certificates in the Operating and Maintenance Instructions.

OPERATING AND MAINTENANCE INSTRUCTIONS

Refer to Division 1, General Requirements, Operating and Maintenance Instructions.

Assemble material in three-ring or post binders, using an index at the front of each volume and tabs for each system or type of equipment. In addition to the data indicated in the General Requirements, include the following information:

- Copies of all approved shop drawings.
- Manufacturer's wiring diagrams for electrically powered equipment
- Records of tests performed to certify compliance with system requirements
- Certificates of inspection by regulatory agencies
- Temperature control record drawings and control sequences
- Parts lists for manufactured equipment
- Valve schedules
- Lubrication instructions, including list/frequency of lubrication done during construction
- Warranties
- Additional information as indicated in the technical specification sections

TRAINING OF OWNER PERSONNEL

Instruct owner personnel in the proper operation and maintenance of systems and equipment provided as part of this project; video tape all training sessions. Include not less than 8 hours of instruction, using the Operating and Maintenance manuals during this instruction. Demonstrate startup and shutdown procedures for all equipment. All training to be during normal working hours.

RECORD DRAWINGS

Refer to Division 1, General Requirements, Record Drawings.

In addition to the data indicated in the General Requirements, maintain temperature control record drawings on originals prepared by the installing contractor/subcontractor. Include copies of these record drawings with the Operating and Maintenance manuals.

PART 2 - PRODUCTS

ACCESS PANELS AND DOORS

LAY-IN CEILINGS:

Removable lay-in ceiling tiles in 2 X 2 foot or 2 X 4 foot configuration provided under Section 09500 are sufficient; no additional access provisions are required unless specifically indicated.

CONCEALED SPLINE CEILINGS:

Removable sections of ceiling tile held in position with metal slats or tabs compatible with the ceiling system used will be provided under Section 09500.

PLASTER WALLS AND CEILINGS:

16 gauge frame with not less than a 20 gauge hinged door panel, prime coated steel for general applications, stainless steel for use in toilets, showers, and similar wet areas, concealed hinges, screwdriver operated cam latch for general applications, key lock for use in public areas, UL listed for use in fire rated partitions if required by the application. Use the largest size access opening possible, consistent with the space and the equipment needing service; minimum size is 12" by 12".

IDENTIFICATION

STENCILS:

Not less than 1 inch high letters/numbers for marking pipe and equipment.

SNAP-ON PIPE MARKERS:

Cylindrical self-coiling plastic sheet that snaps over piping insulation and is held tightly in place without the use of adhesive, tape or straps. Not less than 1 inch high letters/numbers and flow direction arrows for piping marking. W. H. Brady, Seton, Marking Services, or equal.

ENGRAVED NAME PLATES:

White letters on a black background, 1/16 inch thick plastic laminate, beveled edges, screw mounting, Setonply Style 2060 by Seton Name Plate Company or Emedolite- Style EIP by EMED Co., or equal by Marking Services, or W. H. Brady.

VALVE TAGS:

Round brass tags with 1/2 inch numbers, 1/4 inch system identification abbreviation, 1-1/4 inch minimum diameter, with brass jack chains or brass "S" hooks around the valve stem, available from EMED Co., Seton Name Plate Company, Marking Services, or W. H. Brady.

SEALING AND FIRESTOPPING

FIRE AND/OR SMOKE RATED PENETRATIONS:

Manufacturers:

3M, Hilti, Rectorseal, STI/SpecSeal, Tremco, or approved equal.

All firestopping systems shall be provided by the same manufacturer.

Submittals:

Contractor shall submit product data for each firestop system. Submittals shall include product characteristics, performance and limitation criteria, test data, MSDS sheets, installation details and procedures for each method of installation applicable to this project. For non-standard conditions where no UL tested system exists, submit manufacturer's drawings for UL system with known performance for which an engineering judgement can be based upon.

Product:

Fire stop systems shall be UL listed or tested by an independent testing laboratory approved by the Department of Commerce.

Use a product that has a rating not less than the rating of the wall or floor being penetrated. Reference architectural drawings for identification of fire and/or smoke rated walls and floors.

Contractor shall use firestop putty, caulk sealant, intumescent wrapstrips, intumescent firestop collars, firestop blocks, firestop mortar or a combination of these products to provide a UL listed

system for each application required for this project. Provide mineral wool backing where specified in manufacturer's application detail.

NON-RATED PENETRATIONS:

Pipe Penetrations:

At pipe penetrations of non-rated interior partitions, floors and exterior walls above grade, use urethane caulk in annular space between pipe insulation and sleeve. For non-rated drywall, plaster or wood partitions where sleeve is not required use urethane caulk in annular space between pipe insulation and wall material.

Duct Penetrations:

Annular space between duct (with or without insulation) and the non-rated partition or floor opening shall not be larger than 2". Where existing openings have an annular space larger than 2", the space shall be patched to match existing construction to within 2" around the duct.

Where shown or specified, pack annular space with fiberglass batt insulation or mineral wool insulation. Provide 4" sheet metal escutcheon around duct on both sides of partition or floor to cover annular space.

PART 3 - EXECUTION

DEMOLITION

Perform all demolition as indicated on the drawings to accomplish new work. Where demolition work is to be performed adjacent to existing work that remains in an occupied area, construct temporary dust partition to minimize the amount of contamination of the occupied space. Where pipe or duct is removed and not reconnected with new work, cap ends of existing services as if they were new work. Coordinate work with the user agency to minimize disruption to the existing building occupants.

All pipe, wiring and associated conduit, insulation, ductwork, and similar items demolished, abandoned, or deactivated are to be removed from the site by the Contractor. All piping and ductwork specialties are to be removed from the site by the Contractor unless they are dismantled and removed or stored by the user agency. All designated equipment is to be turned over to the user agency for their use at a place and time so designated. Maintain the condition of material and/or equipment that is indicated to be reused equal to that existing before work began.

EXCAVATION AND BACKFILL

Perform all excavation and backfill work to accomplish indicated mechanical systems installation in accordance with Division 31 - Earthwork. Blasting will not be allowed without written permission of the Architect/Engineer.

Install lines passing under foundations with minimum of 1-1/2 inch clearance to concrete and insure there is no disturbance of bearing soil.

CONCRETE WORK

All cast-in-place concrete will be performed by the Division 3 Contractor unless otherwise noted. Provide all layout drawings, anchor bolts, metal shapes, and/or templates required to be cast into concrete or used to form concrete for support of mechanical equipment.

CUTTING AND PATCHING

Refer to Division 1, General Requirements, Cutting and Patching.

BUILDING ACCESS

Arrange for the necessary openings in the building to allow for admittance of all apparatus. When the building access was not previously arranged and must be provided by this contractor, restore any opening to its original condition after the apparatus has been brought into the building.

EQUIPMENT ACCESS

Install all piping, conduit, ductwork, and accessories to permit access to equipment for maintenance and service. Coordinate the exact location of wall and ceiling access panels and doors with the General Contractor, making sure that access is available for all equipment and

specialties. Where access is required in plaster walls or ceilings, furnish the access doors to the General Contractor.

Provide color coded thumb tacks or screws, depending on the surface, for use in accessible ceilings which do not require access panels.

COORDINATION

Verify that all devices are compatible for the surfaces on which they will be used. This includes, but is not limited to, diffusers, registers, grilles, and recessed or semi-recessed heating and/or cooling terminal units installed in/on architectural surfaces.

Coordinate all work with other contractors prior to installation. Any installed work that is not coordinated and that interferes with other contractor's work shall be removed or relocated at the installing contractor's expense.

Cooperate with the test and balance agency in ensuring Section 23 05 93 specification compliance. Verify system completion to the test and balance agency (flushing, pressure testing, chemical treatment, filling of liquid systems, proper pressurization and air venting of hydronic systems, clean filters, clean strainers, duct and pipe systems cleaned, controls adjusted and calibrated, controls cycled through their sequences, etc.), ready for testing, adjusting and balancing work. Install dampers, shutoff and balancing valves, flow measuring devices, gauges, temperature controls, etc., required for functional and balanced systems. Demonstrate the starting, interlocking and control features of each system so the test and balance agency can perform its work.

IDENTIFICATION

Identify equipment in mechanical equipment rooms by stenciling equipment number and service with one coat of black enamel against a light background or white enamel against a dark background. Use a primer where necessary for proper paint adhesion. Do not label equipment such as cabinet heaters and ceiling fans in occupied spaces.

Where stenciling is not appropriate for equipment identification, engraved name plates may be used.

Identify piping not less than once every 30 feet, not less than once in each room, adjacent to each access door or panel, and on both side of the partition where exposed piping passes through walls, floors or roofs. Place flow directional arrows at each pipe identification location. Use one coat of black enamel against a light background or white enamel against a dark background for stenciling, or provide snap-on pipe markers as specified in Part 2 – Products.

Identify valves with brass tags bearing a system identification and a valve sequence number. Valve tags are not required at a terminal device unless the valves are greater than ten feet from the device or located in another room not visible from the terminal unit. Provide a typewritten valve schedule indicating the valve number and the equipment or areas supplied by each valve; locate schedules in each mechanical room and in each Operating and Maintenance manual. Schedules in mechanical rooms to be framed under clear plastic.

Use engraved name plates to identify control equipment.

LUBRICATION

Lubricate all bearings with lubricant as recommended by the manufacturer before the equipment is operated for any reason. Once the equipment has been run, maintain lubrication in accordance with the manufacturer's instructions until the work is accepted by A/E. Maintain a log of all lubricants used and frequency of lubrication; include this information in the Operating and Maintenance Manuals at the completion of the project.

SLEEVES

PIPE SLEEVES:

Provide galvanized sheet metal sleeves for pipe penetrations through interior and exterior walls to provide a backing for sealant or firestopping. Patch wall around sleeve to match adjacent wall construction and finish. Grout area around sleeve in masonry construction. In finished spaces where pipe penetration through wall is exposed to view, sheet metal sleeve shall be installed flush with face of wall.

Pipe sleeves are not required in interior non-rated drywall, plaster or wood partitions and sleeves are not required in existing poured concrete walls where penetrations are core drilled.

Pipe sleeves in new poured concrete construction shall be schedule 40 steel pipe (sized to allow insulated pipe to run through sleeve), cast in place.

Extend the top of sleeve 1 inch above the adjacent floor in piping floor penetrations located in the mechanical rooms and wet locations listed below. In finished areas sleeves shall be flush with rough floor.

For floor pipe penetrations through existing floors in mechanical rooms and wet locations listed below, core drill opening and provide 1-1/2"x 1-1/2" x 1/8" galvanized steel angles fastened to floor surrounding the penetration or group of penetrations to prevent water from getting to penetration. Provide urethane caulk between angles and floor and fasten angles to floor minimum 8" on center. Seal corners water tight with urethane caulk. Or, core drill sleeve opening large enough to insert schedule 40 sleeve and grout area around sleeve with hydraulic setting, non-shrink grout. If the pipe penetrating the sleeve is supported by a pipe clamp resting on the sleeve, weld a collar or struts to the sleeve that will transfer weight to existing floor structure

Wet locations include:

- Toilet Rooms
- Parking ramps
- Swimming pool equipment rooms
- Chemical storage and hazardous waste storage rooms

For pipe penetrations through existing floors located in food service areas, core drill sleeve opening large enough to insert schedule 40 sleeve and grout area around sleeve with hydraulic setting, non-shrink grout. Size sleeve to allow insulated pipe to run through sleeve and paint the sleeve.

Pipe sleeves are not required in cored floor pipe penetrations through existing floors that are not located in mechanical rooms, food service areas or wet locations listed above.

DUCT SLEEVES:

Duct sleeves are not required in non-rated partitions or floors.

Provide sleeve required for fire dampers in fire-rated partitions and floors. Reference fire damper details on drawings.

For duct penetrations through mechanical room floors and wet locations listed below, provide 1-1/2"x 1-1/2" x 1/8" galvanized steel angles fastened to floor around the perimeter of the duct opening to prevent water from getting to floor opening. Provide urethane caulk between angles and floor and fasten angles to floor 8" on center. Seal corners water tight with urethane caulk.

Wet locations include:

- Toilet Rooms
- Parking ramps
- Swimming pool equipment rooms
- Chemical storage and hazardous waste storage rooms
- Food service/kitchen areas (behind/under equipment, cabinets, tables, etc.)

SEALING AND FIRESTOPPING

FIRE AND/OR SMOKE RATED PENETRATIONS:

Install approved product in accordance with the manufacturer's instructions where pipes penetrate a fire/smoke rated surface. When pipe is insulated, use a product which maintains the integrity of the insulation and vapor barrier.

Where firestop mortar is used to infill large fire-rated floor openings that could be required to support weight, provide permanent structural forming. Firestop mortar alone is not adequate to support any substantial weight.

NON-RATED PARTITIONS:

Duct penetrations through non-rated partitions shall require sheet metal escutcheons with fiberglass or mineral wool insulation fill for spaces that include laboratories, clean rooms, animal rooms, kitchens, cart wash rooms, janitor closets, cart wash rooms, toilet rooms, mechanical rooms, conference rooms, private consultation rooms, and where noted on drawings elsewhere.

END OF SECTION

THIS PAGE INTENTIONALLY LEFT BLANK

**SECTION 23 05 13
COMMON MOTOR REQUIREMENTS FOR HVAC EQUIPMENT**

PART 1 - GENERAL

SCOPE

This sections includes requirements for single and three phase motors that are used with equipment specified in other sections:

RELATED WORK

Section 23 09 14 - Electric Instrumentation and Control Devices for HVAC

Section 23 05 14 - Variable Frequency Drives

Division 26 00 00 - Electrical

REFERENCE

Applicable provisions of Division 1 govern work under this section.

REFERENCE STANDARDS

ANSI/IEEE 112 Test Procedure for Polyphase Induction Motors and Generators

ANSI/NEMA MG-1 Motors and Generators

ANSI/NFPA 70 National Electrical Code

QUALITY ASSURANCE

Refer to division 1, General Conditions, Equals and Substitutions.

SHOP DRAWINGS

Refer to division 1, General Conditions, Submittals.

Include with the equipment which the motor drives the following motor information: motor manufacturer, horsepower, voltage, phase, hertz, rpm, full load efficiency. Include project wiring diagrams prepared by the contractor specifically for this work.

OPERATION AND MAINTENANCE DATA

All operations and maintenance data shall comply with the submission and content requirements specified under section GENERAL REQUIREMENTS.

ELECTRICAL COORDINATION

All starters, overload relay heater coils, disconnect switches and fuses, relays, wire, conduit, pushbuttons, pilot lights, and other devices required for the control of motors or electrical equipment are furnished and installed by the Electrical Contractor, except as specifically noted elsewhere in this division of specifications.

Electrical drawings and/or specifications show number and horsepower rating of all motors furnished by this Contractor, together with their actuating devices if these devices are furnished by the Electrical Contractor. Should any discrepancy in size, horsepower rating, electrical characteristics or means of control be found for any motor or other electrical equipment after contracts are awarded, Contractor is to immediately notify the architect/engineer of such discrepancy. Costs involved in any changes required due to equipment substitutions initiated by this contractor will be the responsibility of this contractor. See related comments in Section 23 05 00 - Common Work Results for HVAC, under Shop Drawings.

Electrical Contractor will provide all power wiring and control wiring, except temperature control wiring.

Furnish project specific wiring diagrams to Electrical Contractor for all equipment and devices furnished by this Contractor and indicated to be wired by the Electrical Contractor.

PRODUCT CRITERIA

Motors to conform to all applicable requirements of NEMA, IEEE, ANSI, and NEC standards and shall be listed by U.L. for the service specified.

Select motors for conditions in which they will be required to perform; i.e., general purpose, splashproof, explosion proof, standard duty, high torque or any other special type as required by the equipment or motor manufacturer's recommendations.

Furnish motors for starting in accordance with utility requirements and compatible with starters as specified.

PART 2 - PRODUCTS

THREE PHASE, SINGLE SPEED MOTORS

Use NEMA rated 460 volt, three phase, 60 hertz motors for all motors 1/2 HP and larger unless specifically indicated.

EF-5 and EF-6 require motors that can handle 240/3/60 along with 460/3/60 power because they will be initially installed on the existing sanitation building located on 4th Ave and Michigan Street.

Use NEMA general purpose, continuous duty, Design B, normal starting torque, T-frame or U-frame motors with Class B or better insulation unless the manufacturer of the equipment on which the motor is being used has different requirements. Use open drip-proof motors unless totally enclosed fan-cooled, totally enclosed non-ventilated, explosion-proof, or encapsulated motors are specified in the equipment sections.

Use grease lubricated anti-friction ball bearings with housings equipped with plugged/capped provision for relubrication, rated for minimum AFBMA 9, L-10 life of 20,000 hours. Calculate bearing load with NEMA minimum V-belt pulley with belt center line at the end of NEMA standard shaft extension. Stamp bearing sizes on nameplate.

All open drip-proof motors to have a 1.15 service factor. Other motor types may have minimum 1.0 service factors.

All motors 1 HP and larger, except specially wound motors and inline pump motors 56 frame and smaller, to be high efficiency design with full load efficiencies which meet or exceed the values listed below when tested in accordance with NEMA MG 1.

SINGLE PHASE, SINGLE SPEED MOTORS

Use NEMA rated 115 volt, single phase, 60 hertz motors for all motors 1/3 HP and smaller.

Use permanent split capacitor or capacitor start, induction run motors equipped with permanently lubricated and sealed ball or sleeve bearings and Class A insulation. Service factor to be not less than 1.35.

MOTORS USED ON VARIABLE FREQUENCY DRIVES

In addition to the requirements specified above, the motor must be suitable for use with the drive specified in Section 23 05 14, including but not limited to motor cooling. Motor shall comply with NEMA MG1 Part 31 to provide windings capable to withstand up to 1600 peak Volts with a rise time of 0.1 μ s. Provide bearing protection grounding rings to bleed current from the motor shaft to the motor casing. Manufacturers: Aegis SGR, Inpro/Seal CDR, or equal.

PART 3 - EXECUTION

INSTALLATION

Mount motors on a rigid base designed to accept a motor, using shims if required under each mounting foot to get a secure installation.

When motor will be flexible coupled to the driven device, mount coupling to the shafts in accordance with the coupling manufacturer's recommendations. Using a dial indicator, check angular misalignment of the two shafts; adjust motor position as necessary so that the angular misalignment of the shafts does not exceed 0.002 inches per inch diameter of the coupling hub. Again using the dial indicator, check the shaft for run-out to assure concentricity of the shafts; adjust as necessary so that run-out does not exceed 0.002 inch.

When motor will be connected to the driven device by means of a belt drive, mount sheaves on the appropriate shafts in accordance with the manufacturer's instructions. Use a straight edge to check alignment of the sheaves; reposition sheaves as necessary so that the straight edge

contacts both sheave faces squarely. After sheaves are aligned, loosen the adjustable motor base so that the belt(s) can be added and tighten the base so that the belt tension is in accordance with the drive manufacturer's recommendations. Frequently recheck belt tension and adjust if necessary during the first day of operation and again after 80 hours of operation. Verify the proper rotation of each three-phase motor as it is being wired or before the motor is energized for any reason. Lubricate all motors requiring lubrication. Record lubrication material used and the frequency of use. Include this information in the maintenance manuals.

END OF SECTION

THIS PAGE INTENTIONALLY LEFT BLANK

**SECTION 23 05 29
HANGERS AND SUPPORTS FOR HVAC PIPING AND EQUIPMENT**

PART 1 - GENERAL

SCOPE

This section includes specifications for supports of all HVAC equipment and materials as well as piping system anchors. Included are the following topics:

PART 1 - GENERAL

- Scope
- Related Work
- Reference
- Reference Standards
- Quality Assurance
- Description
- Shop Drawings
- Design Criteria

PART 2 - PRODUCTS

- Pipe Hanger and Support Manufacturers
- Structural Supports
- Pipe Hangers and Supports
- Beam Clamps
- Concrete Inserts
- Continuous Concrete Insert Channels
- Anchors
- Equipment Curbs
- Equipment Stands
- Pipe Penetration through Roof

PART 3 - EXECUTION

- Installation
- Hanger and Support Spacing
- Vertical Riser Clamps
- Concrete Inserts and Continuous Insert Channels
- Anchors
- Roof Mounted Pipe Roller Support; Equipment Rails
- Equipment Curbs
- Equipment Stands
- Pipe Penetration through Roof

RELATED WORK

Section 23 07 00 - HVAC Insulation

REFERENCE

Applicable provisions of Division 1 shall govern work under this section.

REFERENCE STANDARDS

MSS SP-58 Pipe Hangers and Supports - Materials, Design and Manufacture.
MSS SP-59 Pipe Hangers and Supports - Selection and Application.

QUALITY ASSURANCE

Refer to Division 1, General Conditions, Equals and Substitutions.

DESCRIPTION

Provide all supporting devices as required for the installation of mechanical equipment and materials. All supports and installation procedures are to conform to the latest requirements of the ANSI Code for pressure piping.

Do not hang any mechanical item directly from a metal deck or run piping so it rests on the bottom chord of any truss or joist.

Support apparatus and material under all conditions of operation, variations in installed and operating weight of equipment and piping, to prevent excess stress, and allow for proper expansion and contraction.

Protect insulation at all hanger points; see Related Work above.

SHOP DRAWINGS

Refer to division 1, General Conditions, Submittals.

Schedule of all hanger and support devices indicating shields, attachment methods, and type of device for each pipe size and type of service. Reference section 23 05 00.

DESIGN CRITERIA

Materials and application of pipe hangers and supports shall be in accordance with MSS Standard Practice SP-58 and SP-69 unless noted otherwise.

Piping connected to base mounted pumps, compressors, or other rotating or reciprocating equipment is to have vibration isolation supports for a distance of one hundred pipe diameters or three supports away from the equipment, whichever is greater. Standard pipe hangers/supports as specified in this section are required beyond the 100 pipe diameter/3 support distance.

Piping flexible connections and vibration isolation supports are required for piping connected to coils that are in a fan assembly where the entire assembly is mounted on vibration supports; the vibration isolation supports are required for a distance of one hundred pipe diameters or three supports away from the equipment, whichever is greater. Piping flexible connection and vibration isolation supports are not required when the fan section is separately and independently isolated by means of vibration supports and duct flexible connections. Standard pipe hangers/supports as specified in this section are required when there are no vibration isolation devices in the piping and beyond the 100 pipe diameter/3 support distance.

Piping supported by laying on the bottom chord of joists or trusses will not be accepted.

Fasteners depending on soft lead for holding power or requiring powder actuation will not be accepted.

Allow sufficient space between adjacent pipes and ducts for insulation, valve operation, routine maintenance, etc.

PART 2 - PRODUCTS

PIPE HANGER AND SUPPORT MANUFACTURERS

B-Line, Fee and Mason, Grinnell, Kindorf, Michigan Hanger, Unistrut, or approved equal. Grinnell figure numbers are listed below; equivalent material by other manufacturers is acceptable.

STRUCTURAL SUPPORTS

Provide all supporting steel required for the installation of mechanical equipment and materials, whether or not it is specifically indicated or sized, including angles, channels, beams, etc. to suspend or floor support tanks and equipment.

PIPE HANGERS AND SUPPORTS

Until this section gets revised, the consultant will have to insert roller hangers for use on hot piping (LPS, HPS and any other service with a fluid temperature over 220°F) and insulation protection shields for use between a hanger and insulation.

HANGERS FOR STEEL PIPE SIZES 1/2" THROUGH 2":

Carbon steel, adjustable, clevis, black finish. Grinnell figure 65 or 260.

HANGERS FOR STEEL PIPE SIZES 2-1/2" AND OVER:

Carbon steel, adjustable, clevis, black finish; or adjustable steel yoke, cast iron roll, double hanger. Grinnell figure 260. Use Grinnell figure 181 for steam lines.

MULTIPLE OR TRAPEZE HANGERS:

Steel channels with welded spacers and hanger rods if calculations are submitted.

WALL SUPPORT:

Welded steel bracket with hanger. B-Line 3068 Series, Grinnell 194 Series.

Perforated epoxy painted finish, 16-12 gauge min., steel channels securely anchored to wall structure with interlocking, split type, bolt secured, galvanized pipe/tubing clamps. B-Line type S channel with B-2000 series clamps, Grinnell type PS200 H with PS 1200 clamps. When copper piping is being supported, provide flexible elastomeric/thermoplastic isolation cushion material to completely encircle the piping and avoid contact with the channel or clamp, equal to B-Line B1999 Vibra Cushion or provide manufacturers clamp and cushion assemblies, B-Line BVT series, Grinnell PS 1400 series.

VERTICAL RISER SUPPORT:

Carbon steel riser clamp, copper plated when used with copper pipe. Grinnell figure 261 for steel pipe, figure CT121 for copper pipe.

FLOOR SUPPORT FOR PIPE SIZES THROUGH 4”:

Cast iron adjustable pipe saddle, locknut nipple, floor flange, and concrete pier or steel support.

FLOOR SUPPORT FOR PIPE SIZES 5” AND OVER:

Adjustable cast iron roll and stand, steel screws, and concrete pier or steel support.

COPPER PIPE SUPPORT:

Carbon steel ring, adjustable, copper plated or polyvinylchloride coated.

INSULATION PROTECTION SHIELDS:

Galvanized carbon steel of not less than 18 gauge for use on insulated pipe 2-1/2 inch and larger. Minimum shield length is 12 inches. Equal to Grinnell figure 167.

STEEL HANGER RODS:

Threaded both ends, threaded one end, or continuous threaded, black finish.

Size rods for individual hangers and trapeze support as indicated in the following schedule.

Total weight of equipment, including valves, fittings, pipe, pipe content, and insulation, are not to exceed the limits indicated.

Maximum Load (Lbs.)(650°F Maximum Temp.)	Rod Diameter(inches)
610	3/8
1130	1/2
1810	5/8
2710	3/4
3770	7/8
4960	1
8000	1-1/4

Provide rods complete with adjusting and lock nuts.

BEAM CLAMPS

MSS SP-69 Type 23 malleable black iron clamp for attachment to beam flange to 0.62 inches thick for single threaded rods of 3/8, 1/2, and 5/8 inch diameter, for use with pipe sizes 4 inch and less. Furnish with a hardened steel cup point set screw. Grinnell figure 86.

MSS SP-69 Type 28 or Type 29 forged steel jaw type clamp with a tie rod to lock clamp in place, suitable for rod sizes to 1-1/2 inch diameter but limited in application to pipe sizes 8 inch and less without prior approval. Grinnell figure 228.

CONCRETE INSERTS

MSS SP-69 Type 18 wedge type or universal concrete inserts

Wedge type to be constructed of a black carbon steel body with a removable malleable iron nut that accepts threaded rod to 7/8 inch diameter. Wedge design to allow the insert to be held by concrete in compression to maximize the load carrying capacity.

Universal type to be constructed of black malleable iron body with a removable malleable iron nut that accepts threaded rod to 7/8 inch diameter.

Use drilled steel shell with plug type inserts when the inserts are placed after the concrete is poured.

CONTINUOUS CONCRETE INSERT CHANNELS

Steel inserts with an industry standard pre-galvanized finish, nominally 1-5/8 inch wide by 1-3/8 inch deep by length to suit the application, designed to be nailed to concrete forms and provide a linear slot for attaching other support devices. Installed channels to provide a load rating of 2000 pounds per foot in concrete. Manufacturer's standard brackets, inserts, and accessories designed to be used with the channel inserts may be used. Select insert length to accommodate all pipe, duct, and conduit in the area.

ANCHORS

Use welding steel shapes, plates, and bars to secure piping to the structure.

EQUIPMENT CURBS

Manufacturers: Custom Curb, Pate, Roof Products and Systems, ThyCurb, Vent Products.

Constructed of not less than 18 gauge galvanized steel reinforced so it is structurally capable of supporting the intended load with no penetrations through the curb flashing, inside and outside corner sections that are mitered and continuously welded, filled with 3 pound density insulation, integral deck mounting flange, nominal two inch wood nailer, galvanized steel counter flashing. Do not use built-in metal base flashings or cants. Use 18 inch high equipment curbs where the curb completely surrounds the perimeter of the equipment and there is no roof exposed to the weather.

EQUIPMENT STANDS

Use contractor fabricated stand consisting of structural steel members supported by pipe supports; protect the pipe through roof as specified below under Pipe Penetration Through Roof. All steel exposed to the weather to be galvanized or stainless.

PIPE PENETRATION THROUGH ROOF

Manufacturers: Custom Curb, Pate, Roof Products and Systems, ThyCurb, Vent Products.

Curb assembly constructed of not less than 18 gauge galvanized steel reinforced so it is structurally capable of supporting the intended load, inside and outside corner sections that are mitered and continuously welded, filled with 3 pound density insulation, integral deck mounting flange, nominal two inch wood nailer, laminated acrylic clad thermoplastic cover with graduated step boots to accommodate various size pipes, fastening screws for cover, and stainless steel clamps for securing boots around the pipe. Do not use built-in metal base flashings or cants. Height of assembly to be as follows:

Length of Support Rail (inches)	Min. Curb Height Above Deck
to 24	14 inches
25 - 36	18
37 - 48	24
49 - 60	30
61 and over	48

PART 3 - EXECUTION

INSTALLATION

Install supports to provide for free expansion of the piping and duct system. Support all piping from the structure using concrete inserts, beam clamps, ceiling plates, wall brackets, or floor stands. Fasten ceiling plates and wall brackets securely to the structure and test to demonstrate the adequacy of the fastening.

Coordinate hanger and support installation to properly group piping of all trades.

Where piping can be conveniently grouped to allow the use of trapeze type supports, use standard structural shapes or continuous insert channels for the supporting steel. Where continuous insert channels are used, pipe supporting devices made specifically for use with the channels may be substituted for the specified supporting devices provided that similar types are used and all data is submitted for prior approval.

Perform all welding in accordance with standards of the American Welding Society. Clean surfaces of loose scale, rust, paint or other foreign matter and properly align before welding. Use wire brush on welds after welding. Welds shall show uniform section, smoothness of weld metal and freedom from porosity and clinkers. Where necessary to achieve smooth connections, joints shall be dressed smooth.

HANGER AND SUPPORT SPACING

Place a hanger within 12 inches of each horizontal elbow, valve, strainer, or similar piping specialty item.

Where several pipes can be installed in parallel and at the same elevation, provide multiple or trapeze hangers.

Support riser piping independently of connected horizontal piping.

Adjust hangers to obtain the slope specified in the piping section of this specification.

Space hangers for pipe as follows:

Pipe Material	Pipe Size	Max Horiz. Spacing	Max Vert. Spacing
Steel	1/2" through 1-1/4"	6'-6"	15'-0"
Steel	1-1/2" through 6"	10'-0"	15'-0"
Copper	1/2" through 3/4"	5'-0"	10'-0"
Copper	1" through 1-1/4"	6'-0"	10'-0"
Copper	1-1/2" through 2-1/2"	8'-0"	10'-0"
Copper	3"	10'-0"	10'-0"
Copper	4" and above	12'-0"	10'-0"

VERTICAL RISER CLAMPS

Support vertical piping with clamps secured to the piping and resting on the building structure or secured to the building structure below at each floor.

Piping 5" and above, of lengths exceeding 30 feet, shall be additionally supported on base elbows secured to the building structure, with flexible supporting hangers provided at top of riser to allow for pipe expansion.

CONCRETE INSERTS AND CONTINUOUS INSERT CHANNELS

Select size based on the manufacturer's stated load capacity and weight of material that will be supported. Locate continuous insert channels on 8'-0" maximum centers and 2'-0" from corners. Furnish inserts to the General Contractor for placement in concrete formwork. Use inserts for suspending hangers from reinforced concrete slabs and sides of reinforced concrete beams. Provide hooked rod to concrete reinforcement section for inserts carrying pipe over 4 inch size. Where concrete slabs form finished ceiling, provide inserts that are flush with the slab surface.

Where inserts are omitted, drill through concrete slab from below and provide thru-bolt with recessed square steel plate and nut recessed into and grouted flush with the slab.

ANCHORS

Install where indicated on the drawings and details. Where not specifically indicated, install anchors at ends of principal pipe runs and at intermediate points in pipe runs between expansion loops. Make provisions for preset of anchors as required to accommodate both expansion and contraction of piping.

ROOF MOUNTED PIPE ROLLER SUPPORT; EQUIPMENT RAILS

Use for all pipe on roof. Secure bottom of support flat on roof deck. Apply two coats of zinc rich paint to cut edges of all galvanized steel elements. Flashing and counter flashing by the General Contractor.

Add requirements specific to the project.

EQUIPMENT CURBS

Secure bottom of support flat on roof deck. Secure equipment to curb in accordance with equipment manufacturer's instructions. Flashing and counter flashing by the General Contractor.

PIPE PENETRATION THROUGH ROOF

Install at points where pipes penetrate roof. Install as shown on the drawings, as detailed and according to the manufacturer's installation instructions. Flashing and counter flashing by the General Contractor.

END OF SECTION

**SECTION 23 05 93
TESTING, ADJUSTING, AND BALANCING FOR HVAC**

PART 1 - GENERAL

SCOPE

This section includes all air and water testing, adjusting and balancing for the entire project. This work will be performed by a Contractor independent from the Mechanical Contractor and contracted directly with Dane County. Included are the following topics:

PART 1 - GENERAL

- Scope
- Reference
- Reference Standards
- Description
- Related Work
- Pre-Balance Conference
- Submittals

PART 2 - PRODUCTS

- Instrumentation

PART 3 - EXECUTION

- Preliminary Procedures
- Performing Testing, Adjusting and Balancing
- Deficiencies

REFERENCE

Applicable provisions of the General Conditions, Supplementary General Conditions and General Requirements in Division 1 govern work under this section.

REFERENCE STANDARDS

AABC	National Standards for Testing and Balancing Heating, Ventilating, and Air Conditioning Systems, Fifth Edition, 1989.
ASHRAE	ASHRAE Handbook, 1987 HVAC Systems and Applications, Chapter 57, Testing Adjusting and Balancing.
NEBB	Procedural Standards for Testing Adjusting Balancing of Environmental Systems, Fifth Edition, 1991.

DESCRIPTION

Provide an independent test and balance agency to perform all testing, adjusting, and balancing of air and hydronic systems required for this project. Work related to the testing, adjusting, and balancing that must be performed by the installing mechanical contractor is specified in other section of these specifications.

Provide total mechanical systems testing, adjusting and balancing. Requirements include the balance of air and water distribution, adjustment of new and existing systems to provide design quantities indicated on the drawings, electrical measurement and verification of performance of all equipment, all in accordance with standards published by AABC or NEBB.

Test, adjust and balance all air and hydronic systems so that each room, piece of equipment or terminal device is using the quantities indicated on the drawings and in the specifications.

Accomplish testing, adjusting and balancing work in a timely manner that allows partial occupancy of major buildings, occupancy of one building when the project involves many buildings, and completion of the entire project in the time stated in the Instruction to Bidders and in accordance with the completion schedule established for this project.

The test and balance agency is encouraged to make periodic site visits to make sure that provisions are being made to accomplish the specified testing, adjusting and balancing work. If problems are found, handle as specified in Part 3 under Deficiencies.

RELATED WORK

Division 23 00 00 - Heating, Ventilating, and Air-Conditioning (HVAC) for hvac shop drawings to be given to the test and balance agency and for coordination between the Division 23 00 00 contractor and the firm performing the work in this section.

Division 23 00 00 drawings and specifications which define the scope of the systems to be balanced. Refer to construction bulletins for proposed changes and to change orders for changes that have been accepted.

Division 26 00 00 - Electrical drawings and specifications which define the scope of the electrical systems that serve the mechanical equipment.

PRE-BALANCE CONFERENCE

Prior to beginning testing, adjusting and balancing, schedule and conduct a conference with the Architect/Engineer, and the mechanical system and temperature control system installing Contractors. The objective is final coordination and verification of system operation and readiness for testing, adjusting and balancing procedures and scheduling procedures with the above mentioned parties. Indicate work required to be completed prior to testing, adjusting, and balancing and identify the party responsible for completion of that work.

SUBMITTALS

See also Related Work in this section.

Submit testing, adjusting and balancing reports bearing the seal and signature of the NEBB or AABC Certified Test and Balance Supervisor. The reports to be certified proof that the systems have been tested, adjusted and balanced in accordance with the referenced standards; are an accurate representation of how the systems have been installed and are operating; and are an accurate record of all final quantities measured to establish normal operating values of the systems.

Submission: Submit four (4) complete sets of reports. If information is incomplete or further testing, adjusting and balancing is deemed necessary, resubmit four (4) final complete sets. Distribution of submittals will be:

Architect/Engineer
Owner

Two (2) copies
Two (2) copies.

Format: Bind report forms in three-ring binders or portfolio binders. Label edge or front with label identifying project name, project number and descriptive title of contents. Divide the contents of the report into the below listed divisions, separated by divider tabs:

- General Information
- Summary
- Air Systems
- Hydronic Systems
- Special Systems

Contents: Provide the following minimum information, forms and data:

General Information: Inside cover sheet identifying Test and Balance Agency, Contractor, Architect, Engineer, Project Name and Project Number. Include addresses, contact names and telephone numbers. Also include a certification sheet containing the seal and signature of the Test and Balance Supervisor.

Summary: Provide summary sheet describing mechanical system deficiencies. Describe objectionable noise or drafts found during testing, adjusting and balancing. Provide recommendations for correcting unsatisfactory performances and indicate whether modifications required are within the scope of the contract, are design related or installation related. List instrumentation used during testing, adjusting and balancing procedures.

The remainder of the report to contain the appropriate standard NEBB or AABC forms for each respective item and system. Fill out forms completely. Where information cannot be obtained or is not applicable indicate same.

PART 2 - PRODUCTS

INSTRUMENTATION

Provide all required instrumentation to obtain proper measurements. Application of instruments and accuracy of instruments and measurements to be in accordance with the requirements of NEBB or AABC Standards and instrument manufacturer's specifications.

All instruments used for measurements shall be accurate, and calibration histories for each instrument to be available for examination by Architect/Engineer upon request. Calibration and maintenance of all instruments to be in accordance with the requirements of NEBB or AABC Standards

PART 3 - EXECUTION

PRELIMINARY PROCEDURES

Obtain preconstruction meeting report, applicable construction bulletins, applicable change orders and approved shop drawings of equipment, outlets/inlets and temperature controls.

Check filters for cleanliness, dampers and valves for correct positioning, equipment for proper rotation and belt tension, temperature controls for completion of installation, hydronic systems for proper charge and purging of air, and refrigerant coils charged.

Identify deficiencies preventing completion of testing, adjusting and balancing procedures. Do not proceed until systems are fully operational with all components necessary for complete testing, adjusting and balancing. Installing Contractors are required to provide personnel to check and verify system completion, readiness for balancing and assist Balancing Agency in providing specified system performance.

PERFORMING TESTING, ADJUSTING AND BALANCING

Perform testing, adjusting and balancing procedures on each system identified, in accordance with the detailed procedures outlined in the referenced standards except as may be modified below.

Unless specifically instructed in writing, all work in this specification section is to be performed during the normal workday.

In areas containing ceilings, remove ceiling tile to accomplish balancing work; replace tile when work is complete and provide new tile for any tile that are damaged by this procedure. If the ceiling construction is such that access panels are required for the work of this section and the panels have not been provided, inform the owner's project representative.

Cut insulation, ductwork and piping for installation of test probes to the minimum extent necessary for adequate performance of procedures. Patch using materials identical to those removed, maintaining vapor barrier integrity and pressure rating of systems.

In air systems employing filters, blank off sufficient filter area to simulate a pressure drop that is midway between that of a clean filter and that of a dirty filter.

Measure and record system measurements at the fan and/or pump to determine total flow. Adjust equipment as required to yield specified total flow at terminals. Proceed taking measurements in mains and branches as required for final terminal balancing. Perform terminal balancing to specified flows balancing branch dampers, deflectors, extractors and valves prior to adjustment of terminals.

Measure and record static air pressure conditions across fans, coils and filters. Indicate in report if cooling coil measurements were made on a wet or dry coil and if filter measurements were made on a clean or dirty filter. Spot check static air pressure conditions directly ahead of terminal units.

Adjust outside air, return air and relief air dampers for design conditions at both the minimum and maximum settings and record both sets of data. Balance modulating dampers at extreme conditions and record both sets of data. Balance variable air volume systems at maximum air flow rate, full cooling, and minimum flow rate, full heating; record all data.

Adjust register, grille and diffuser vanes and accessories to achieve proper air distribution patterns and uniform space temperatures free from objectionable noise and drafts within the capabilities of the installed system.

Provide fan and motor drive sheave adjustments necessary to obtain design performance. Include in scope of services drive changes specifically noted on drawings, if any. If work of this section indicates that any drive or motor is inadequate for the application, advise the owner's project representative by giving the representative properly sized motor/drive information (in accordance with manufacturers original service factor and installed motor horsepower requirements); make sure that any change will keep the duct/piping system within its design limitations with respect speed of the device and pressure classification of the distribution system. Time and material for motor/drive changes will be considered a reimbursable expense and will require an itemized cost breakdown of all time and drive changes submitted to owner's project representative; prior authorization is needed before this work is started.

Areas or rooms designed to maintain positive, negative or balanced air pressures with respect to adjacent spaces, as indicated by the design air quantities, require special attention. Adjust fan drives, distribution dampers, terminals and controls to maintain indicated pressure relationship.

Final air system measurements to be within the following range of specified cfm:

Fans	-5% to +10%
Supply grilles, registers, diffusers	-5% to +10%
Return/exhaust grilles, registers	-5% to -10%
Room pressurization air	-5% to +5%

Final water system measurements must be within the following range of specified gpm:

Heating flow rates	0% to -10%
Cooling flow rates	-5% to +5%

Contact the temperature control Contractor for assistance in operation and adjustment of controls during testing, adjusting and balancing procedures. Cycle controls and verify proper operation and setpoints. Include in report description of temperature control operation and any deficiencies found.

Permanently mark equipment settings, including damper and valve positions, control settings, and similar devices allowing settings to be restored. Set and lock memory stops.

Leave systems in proper working order, replacing belt guards, closing access doors and electrical boxes, and restoring temperature controls to normal operating settings.

DEFICIENCIES

Division 23 00 00 contractor to correct any installation deficiencies found by the test and balance agency that were specified and/or shown on the Contract Documents to be performed as part of that division of work. Test and balance agency will notify the Architect/Engineer of these items and instructions will be issued to the Division 23 00 00 contractor for correction of the deficient work. All corrective work to be done at no cost to the Owner.

END OF SECTION

**SECTION 23 09 14
ELECTRIC INSTRUMENTATION AND CONTROL DEVICES FOR HVAC**

PART 1 - GENERAL

SCOPE

This sections includes pneumatic control system specifications for all HVAC work as well as related pneumatic control for systems found in other specification sections. Included are the following topics:

PART 1 - GENERAL

- Scope
- Point List
- Related Work
- Quality Assurance
- Reference Standards
- System Description
- Submittals
- Design Criteria
- Operating and Maintenance Manuals
- Training
- Material Delivery and Storage

PART 2 - PRODUCTS

- Manufacturers
- Control Dampers
- Control Systems Instrumentation
- Electric Thermostats
- Timeclocks
- Duct Smoke Detector and Fire Alarm Interface Modules
- Differential Pressure Switches
- Current Status Switches
- Variable Refrigerant Flow Controls
- Gas Detectors
- Power Supplies
- Radiant Heating Multiple Zone Control
- Water Flow Measurement
- Temperature Control Panels
- Temperature Sensors
- Pressure Transducers(Air)
- Pressure Transducers (Liquid)

PART 3 - EXECUTION

- Installation
- Control and Smoke Dampers
- Control System Instrumentation
- Room Thermostats and Temperature Sensors
- Low Limit Thermostats (Freezestats)

RELATED WORK

Applicable provisions of Division 1 govern work under this Section.

Section 23 05 93 - Testing, Adjusting, and Balancing for HVAC - Coordination

Section 23 09 93 - Sequence of Operation

Section 23 33 00 - Ductwork Accessories - for control damper installation

Division 23 - HVAC - Equipment provided to be controlled or monitored
Division 26 - Electrical - Installation requirements & Equipment provided to be controlled or monitored
Division 28 - Electronic Safety and Security

QUALITY ASSURANCE

Installing contractor must be a manufacturer's branch office or an authorized representative of the control equipment manufacturer that provides engineering and commissioning of the manufacturers control equipment, submit written confirmation of such authorization from the manufacturer. Indicate in letter of authorization that installing contractor has successfully completed all necessary training required for engineering, installation, and commissioning of equipment and systems to be provided for the project, and that such authorization has been in effect for a period of not less than three years.

REFERENCE STANDARDS

ANSI B16.22	Wrought Copper and Wrought Copper Alloy Solder Joint Pressure Fittings
ANSI/ASTM B32	Specification for Solder Metal
ASTM B75	Seamless Copper Tube
ASTM D1693	Environmental Stress-Cracking of Ethylene Plastics
ASTM D 635	Standard Test Method for Rate of Burning and/or Extent and Time of Burning of Plastics in a Horizontal Position
UL 94 Appliances	Tests for Flammability of Plastic Materials for Parts in Devices and
AMCA 500-D	Laboratory Method of Testing Dampers for Rating

SYSTEM DESCRIPTION

System is to be electric/electronic.

SUBMITTALS

Include the following information:

Manufacturer's data sheets indicating model number, pressure/temperature ratings, capacity, methods and materials of construction, installation instructions, and recommended maintenance. General catalog sheets showing a series of the same device is not acceptable unless the specific model is clearly marked.

Schematic flow diagrams of systems showing fans, pumps, coils, dampers, valves, and other control devices. Label each device with setting or adjustable range of control. Indicate all wiring, clearly, differentiating between factory and field installed wiring. Wiring should be shown in schematics that detail contact states, relay references, etc. Diagrammatic representations of devices alone are not acceptable.

Details of construction, layout, and location of each temperature control panel within the building, including instruments location in panel and labeling. Also include on drawings location of mechanical equipment controlled (room number), horsepower and flow of motorized equipment (when this data is available on plans), locations of all remote sensors and control devices (either by room number or column lines).

Schedule of control dampers indicating size, leakage rating, arrangement, pressure drop at design airflow, and number and size of operators required.

Schedule of control valves indicating system in which the device is to be used, rated capacity, flow coefficient, flow required by device served, actual pressure drop at design flow, size of operator required, close-off pressure, and locations where valves are to be installed.

A complete description of each control sequence for equipment that is not controlled by direct digital controls. Direct digital controlled equipment control sequences will be provided by the DDC control contractor.

Prior to request for final payment, submit record documents which accurately record actual location of control components including panels, thermostats, wiring, and sensors. Incorporate changes required during installation and start-up.

DESIGN CRITERIA

Size all control apparatus to properly supply and/or operate and control the apparatus served.

Provide control devices subject to corrosive environments with corrosion protection or construct them so they are suitable for use in such an environment.

Provide devices exposed to outside ambient conditions with weather protection or construct them so they are suitable for outdoor installation.

Use only UL labeled products that comply with NEMA Standards. Electrical components and installation to meet all requirements of the electrical sections (Division 26) of project specifications.

OPERATING AND MAINTENANCE MANUALS

Furnish three (3) bound operating and maintenance manuals for review and approval prior to substantial completion, performance testing, and training. Manuals to include the following:

- Operation and maintenance instructions for the equipment and systems provided, including the following items:
- Recommendations for frequency of service and preventative maintenance.
- List indicating types and grades of oil and/or grease, packing materials, normal and abnormal tolerances for devices, and method of equipment adjustment.
- A description of recommended replacement parts and materials which the owner should stock.
- A summary of equipment vendors, or location where replacement parts can be purchased.
- Manufacturer's literature indicating features, materials of construction, and operating limits of installed equipment. (Brochures giving brief descriptions of multiple pieces of control apparatus are not acceptable.)
- A complete set of record control drawings.
- Name, address, and telephone number of the person or office to contact for service during the warranty period.
- Name, address, and telephone number of the person or service organization to be contacted for service after the warranty period.

TRAINING

Provide a minimum of 8 hours of training to the owner, concerning the proper operation and maintenance of all control systems and all sensing, monitoring, and control equipment. Training sessions shall be conducted during normal business hours after system start-up and acceptance by A/E.

Submit operating and maintenance manuals to Owner a minimum of five (5) working days prior to training session. Use these manuals as the basis for instruction at all training sessions.

MATERIAL DELIVERY AND STORAGE

Provide factory shipping cartons for each piece of equipment and control device. This contractor is responsible for storage of equipment and materials inside and protected from the weather.

PART 2 - PRODUCTS

MANUFACTURERS

Alerton, Invensys (Siebe), Distech, or approved equal. Actuators shall be manufactured by Belimo.

CONTROL DAMPERS

Provide control dampers shown on the plans and as required to perform the specified functions. Dampers shall be rated for velocities that will be encountered at maximum system design and rated for pressure equal or greater than the ductwork pressure class as specified in Section 23 31 00 of the ductwork where the damper is installed.

Use only factory fabricated dampers with mechanically captured replaceable resilient blade seals, stainless steel jamb seals and with entire assembly suitable for the maximum temperature and air velocities encountered in the system.

All dampers in aluminum ductwork shall be constructed of stainless steel or aluminum.

Dampers in galvanized ductwork shall be constructed of galvanized steel and/or aluminum.

All dampers, unless otherwise specified, to be rated at a minimum of 180° F working temperature. Leakage testing shall be certified to be based on latest edition of AMCA Standard 500-D and all dampers, unless otherwise specified, shall have leakage ratings as follows:

Damper Class	Differential Pressure	Leakage
Class IA	1" w.g.	≤3 CFM/ft ²
Class I	4" w.g.	≤8 CFM/ft ²
Class I	8" w.g.	≤11 CFM/ft ²
Class I	12" w.g.	≤14 CFM/ft ²

Leakage rate dampers for differential pressures that they will encounter at maximum system design pressures.

Steel framed dampers: Nailor models 2010 & 2020; Greenheck models VCD-33 & VCD-42; Johnson Controls model V-1330; Ruskin Models CD60 & CD40; other approved equal.

Aluminum frame and blade dampers: Nailor models 2010EAF & 202EAF; Greenheck model VCD-43; Ruskin model CD50; Arrow model AFD-20; other approved equal.

Dampers used for isolation on the discharge of centrifugal fans shall have damper blades perpendicular to the fan shaft to minimize system effect. Dampers mounted with blades vertically shall be designed for vertical blade orientation.

Maximum damper width is 48 inches; where required width exceeds 48 inches, use multiple damper sections. Inside frame free area shall be a minimum of 90% of total inside duct area.

Multiple width damper sections shall utilize jack shaft linkages unless noted below. Sections over 144 inches wide shall be actuated from two locations on the jack shaft. Double width damper sections for two-position operation may be actuated without jack shafts if each damper section is actuated separately. Dampers that have multiple width and multiple vertical sections shall have a jackshaft for each vertically stacked set of dampers and be provided with crossover linkages between jack shafts to transfer uneven loading.

Jack shafts shall be extended outside of the ductwork for external actuator mounting. Provide bearings on the point of exit for support of damper shafts to prevent wear on the shaft and the ductwork. If locating actuators out of the air stream is impossible, obtain mounting location approval from the designer unless the contract documents indicate in air stream mounting is acceptable. In no cases shall damper actuators for fume exhaust systems be located in the air stream or require entering the air stream to service an actuator.

Provide weatherproof stainless steel enclosures or NEMA 4 watertight actuator housing to prevent actuator failure or freeze-up when mounting in locations exposed to harsh environments or outdoor locations.

Size operators for smooth and positive operation of devices served, and with sufficient torque capacity to provide tight shutoff against system temperatures and pressure encountered. For electric modulating actuation, use fully proportional actuators with 0-10VDC inputs and zero and span adjustments. For two-position electric actuation use 24 VAC for DDC controlled actuators, 120 VAC actuators may be used for hardwire interlocking. Actuator stroke times shall match the requirements of the DDC controllers provided under 23 09 23 and/or the specific system requirements for proper operation. All electric actuators will be provided with overload protection to prevent motor from damage when stall condition is encountered. Equip operators with spring return for applications involving fire, freeze protection, moisture protection or specified normally open/closed operation. Provide damper end switches with form "C" contacts where control sequences require damper position indication.

All power required for electric actuation shall be provided by this contractor if it is not able to be directly provided from the DDC controller.

Provide operators with linkages and brackets for mounting on device served.

CONTROL VALVES

Provide all control valves as shown on the plans/details and as required to perform functions specified. Spring ranges must be selected to prevent overlap of operation and simultaneous heating and cooling.

Size operators to allow smooth and positive operation of devices served and to provide sufficient torque capacity for tight shutoff against system temperatures and pressure encountered. For electric modulating actuation, use fully proportional actuators with 0-10VDC inputs and zero and span adjustments unless specified otherwise in the chart below. If TriState with feedback is specified, valve position shall be fed back to the controller and controller shall position valve based on this feedback. For two-position electric actuation use 24 VAC for DDC controlled actuators, 120 VAC actuators may be used for hardwire interlocking. Electric actuators, for applications other than terminal units, shall be provided with a manual override capability. All electric actuators shall be provided with a visible position indicator.

All power required for electric actuation shall be provided by this contractor if it is not able to be directly provided from the DDC controller.

Provide operators that are full proportioning or two-position, as required for specified sequence of operation. Provide spring-return for applications involving fire, freeze protection, moisture protection or specified normally open/closed operation. Valves shall move to their fail positions on loss of electrical power.

Two-position shut-off valves shall be sized for a maximum pressure drop of 2 PSI at design flow and shall be a minimum of line size.

Provide operators with linkages and brackets for mounting on device served.

All valves unless specifically noted on the plans or indicated below shall be globe style valves.

VALVE SERVING	TYPE	SIGNAL	SPRING RETURN REQUIRED	FAIL POSITION
	Globe Butterfly (BF) Ball Press Independent Ball (PI Ball)	0-10 VDC TriState (24VAC) 2-Position Elect Pneumatic (Pneu)	Yes No	Open (thru Coil) Closed (bypass Coil) Last Position
Reheat Coil	Globe or Ball	0-10 VDC or TriState w/feedback	No	Last Position
Standalone Radiation	Globe or Ball	0-10 VDC	No	Last Position
CUH and UH	Globe or Ball	TriState or 2-Pos Elect	Yes	Open
HW Heat Exchanger	Globe	0-10 VDC	Yes	Open

See plan details, notes, and schedules for where two-way and three-way valves should be used.

1. Equivalent Cv butterfly valves may be used where 3" and larger globe valves would be required.

WATER SYSTEMS:

Use equal percentage valves for two-way control valves; size for a pressure drop not less than 4 psi or more than 6 psi. Note: For low flows, the required minimum Cv size will result in lower pressure drop than 4 psi.

Use three-way valves sized for a maximum pressure drop of 5 psi and that have linear characteristics so that the valve pressure drop remains constant regardless of the valve position.

Globe valves 2" and smaller: Cast bronze or forged brass body, brass plug and brass or stainless steel seat, stainless steel stem, screwed ends, suitable for use on water systems at 150 psig and 240° F. Seat leakage with actuator supplied will meet ANSI class IV leakage (0.01%). For globe valves that are specified to fail in place, valves shall be open when the stem is up. Only the following globe valve body styles will be acceptable for terminal unit control: Siemens Powermite 599 VF Series (599 VE Series Zone Valves are not acceptable), Invensys VB7200 Series, Johnson Controls VG7000 Series, and Honeywell V5011/V5013 Series. Minimum size for globe valves shall be 1.5 Cv.

Globe valves 2 1/2" and larger: Iron body, brass plug and seat, stainless steel stem, spring loaded Teflon, or EPDM packing, flanged ends, suitable for use on water systems at 150 psig and 240° F.

Butterfly valves: Iron body, stainless steel shaft, bronze bearings, and resilient seat. Disc to be aluminum-bronze, nickel-plated ductile iron, cast iron with welded nickel edge, or stainless steel. Valve assembly to be bubble tight, suitable for use on water systems at 150 psig and 240° F. When butterfly valves are used in modulating applications, entering and leaving pipe sizes and required transition distances shall be detailed on the control valve submittals. The control contractor shall be responsible for coordinating the proper pipe sizes and transitions with the mechanical contractor to provide the correct Cv at 70° open position.

Characterized Ball Valves: The following manufacturers are acceptable: Honeywell, Belimo, Johnson Controls, KMC Controls, Yamatake, Bray. For use on terminal units only where specified above. Forged brass or bronze body, stainless steel shaft and ball, reinforced Teflon or PTFE ball seals, double O-ring stem seals, characterized disk, maximum of ANSI Class IV (0.01%) leakage, suitable for use on water systems at 150 psig and 212° F. Minimum size for ball valves shall be 1.0 Cv.

Pressure Independent Characterized Ball Valves: The following manufacturers and models are acceptable: Belimo model PICCV and Griswold Controls PIC-V. For use on terminal units only where specified above. Forged brass or bronze body, reinforced Teflon or PTFE ball seals, double O-ring stem seals, characterized disk, maximum of ANSI Class IV (0.01%) leakage,

suitable for use on water systems at 150 psig and 212° F. Flow shall be varied by actuator position and at any given position, flow through the valve shall not vary more than +/- 5% due to system pressure fluctuations across the valve in the selected operating range. Valves shall be pressure independent between a system differential pressure of 8 and 50 PSID. Minimum size for ball valves shall be 1.0 Cv.

CONTROL SYSTEM INSTRUMENTATION

DUCT THERMOMETERS:

3-1/2" dial type with swivel mount. Maximum scale graduations of 2°F. Provide averaging type, liquid filled capillary sensing element.

REMOTE BULB THERMOMETERS:

3-1/2 inch dial type with recalibration screw on face. Accuracy within 1% of scale range. Thermometers with sensing elements in air ducts with an area of above 4 square feet to have averaging elements. Provide separable wells for all pipeline applications.

ELECTRIC THERMOSTATS

LINE VOLTAGE THERMOSTATS:

Use single or two pole as required, with minimum rating equal to electrical load of device being controlled. Provide integral manual On/Off/Auto selector switch, maximum dead band of 2°F, concealed temperature adjustment, and locking cover.

LOW LIMIT THERMOSTATS (freezestats):

Electric two-position type with temperature sensing element and manual reset. Unit to be capable of opening control circuit if any one-foot length of sensing element is subject to a temperature below the setpoint. Length of sensing element to be not less than one lineal foot per square foot of coil surface areas. Unless otherwise indicated, set low limit controls at 36°F.

REMOTE BULB THERMOSTATS:

Line voltage type with single pole, double throw switch of adequate rating for the applied load. Thermostat to have adjustable setpoint suitable for controlled load.

FIRESTATS:

UL labeled, manual reset, line voltage type with 135°F setpoint.

TIMELOCKS

UL listed, digital, 7-day, minimum of 10 on/off programs per day, holiday programming, automatic daylight savings switchover, and minimum of seven-day battery back-up.

Intermatic ET1705CPD82 electronic timeclock with NEMA 3R indoor/outdoor lockable polycarbonate enclosure with clear cover.

DUCT SMOKE DETECTOR AND FIRE ALARM INTERFACE MODULES

Detectors with auxiliary contacts or fire alarm control modules will be provided by others. Provide wiring, conduit, and necessary interface with fire alarm system to perform specified sequence of operation.

DIFFERENTIAL PRESSURE SWITCHES

Differential pressure switches shall sense both inlet and outlet of fans and pumps. Device shall be rated for 150% of maximum system pressures that may be encountered. Provide with pressure differential that will be required to meet specified operation and/or to prevent nuisance "toggling" of the device in the system served.

CURRENT STATUS SWITCHES

Provide a current sensor with adjustable threshold and digital output with LED display, equal to a Veris model H-708/H-904. Threshold adjustment must be by a multi-turn potentiometer or set by multiprocessor that will automatically compensate for frequency and amperage changes associated with variable frequency drives. When used on variable speed motor applications, use a current sensor that will not change state due to varying speeds.

GAS DETECTORS

CO/NO2 & Methane(Natural Gas) detection system shall be manufactured by Vulcain, or QEL.

Base of design is QEL M-series panel networked remote gas detectors with a central panel. The Central panel shall be furnished with MODBus communications to BAS and relay connections for fire alarm panel. The relays shall communicate type of gas and which garage/room the detector is located in. The panel shall have remote detectors for CO, NO2 and Methane(CH4 or Natural Gas). The panel shall have 2 alarm modes. Remote Methane detectors shall be included in sequence where shown on the plans.

- Low alarm shall engage Make up air unit and garage exhaust fans
- High alarm shall continue energizing make up air unit and exhaust fan and shall energize an audible alarm in garage.

Gas sensors shall be installed and calibrated by a factory certified installer. CO sensors shall be mounted 3'-5' above the floor, NO2 sensors shall be mounted within 3'-0" – 5'-0" from the roof deck or ceiling. Methane sensors shall be mounted within 18" below the roof deck or ceiling.

Include an Edwards signals grey horn strobe with green light 24VDC horn strobe in each garage as located on the plans.

The factory certified installer shall conduct the owner training and provide maintenance personal with contact information for future system calibrations.

Gas detector settings

Type of Gas	Units measure	Range	1 st Alarm Limit	2 nd Alarm limit
CO	PPM	0-250	35	150
NO2	PPM	0-10	1	5
CH4	%of LEL	0-100	25	75

POWER SUPPLIES

Provide all required power supplies for transducers, sensors, transmitters and relays. All low voltage transformers shall have a resettable secondary circuit breaker.

WATER FLOW MEASUREMENT

Manufacturers: Onicon Inc., Badger Meter Data Industrial, Emerson Rosemount, Yokogawa., or approved equal.

Provide an Insertion style Impeller mechanical flow meter with pulsed frequency output. The flow meter shall be installed in either the supply or return pipe of the system to be measured following the manufacturer's installation instructions. Full bore style flow meters shall be installed via flanges matching the ANSI class (150, 300) required for the application. The installing contractor is responsible for providing suitable mating flanges. Sensor shall be 316 stainless steel

The manufacturer shall provide a certificate of NIST traceable wet-calibration for each flow meter. Accuracy shall be as follows: ± 1% of reading over a 10:1 turndown (from 2 to 20 ft/s) Overall rangeability shall be from 0.25 ft/s to 20 ft/s (80:1 turndown ratio).

The flow meter shall have a maximum operating pressure of 400 PSI, maximum operating temperature of 200° F (optional 300° F peak) and a pressure drop of less than 1 PSI at 17 feet per second flow velocity.

Provide a BTU Measurement System that shall consist of a flow sensor, two temperature sensors, a BTU meter, thermowells and all required mechanical installation hardware. The BTU meter shall include a front panel mounted display for BTU total, liquid flow rate, supply temperature and return temperature. The meter shall be supplied by 24VAC or 24VDC to provide power to the BTU meter electronics, flow meter, and temperature sensors.

The BTU measurement system shall provide a BACnet MSTP RS-485 communication interface that will provide information corresponding to total thermal energy transfer, supply temperature, return temperature, and liquid flow rate. For meters that do not have integral BACnet communications, provide a separate gateway device that will provide a BACnet MSTP communication interface. All programming of the gateway device shall be provided by this contractor. Temperature sensors shall be calibrated and matched for the specific temperature range for each application. The calculated differential temperature used in the energy calculation shall be accurate to within $\pm 0.15^{\circ}\text{F}$ (including the error from individual temperature sensors, sensor matching, input offsets, signal conditioning, and calculations). When DDC PI control loops are specified in 23 09 93 that use flow or temperatures from the flow meter and BTU measurement system, provide a compatible discrete hardwired output to the DDC controller that is doing the control loop in addition to the information provide through the communication interface.

TEMPERATURE CONTROL PANELS

Constructed of steel or extruded aluminum, with hinged door, keyed lock, and baked enamel finish. Install controls, relays, transducers and automatic switches inside panels. Label devices with permanent printed labels and provide as-built wiring/piping diagram within enclosure. Provide raceways for wiring and poly within panel for neat appearance and to separate high and low voltage wiring. Provide termination blocks and resettable circuit breaker for 120VAC power wiring. Provide label within the panel indicating circuit number of 120VAC serving panel. Label outside of panel with panel number corresponding to plan tags and as-built control drawings as well as building system(s) served.

Provide a service shutdown toggle switch for each air handling unit system located inside the temperature control panel that will initiate a logical shutdown of the air handling unit system. Label the switch so it is clear which position is shutdown and which is auto.

TEMPERATURE SENSORS

Thermistor temperature sensor manufacturers: PreCon, BAPI, Badger Data Industrial, and ACI

Use thermistor or RTD type temperature sensing elements constructed so accuracy and life expectancy is not affected by moisture, physical vibration, or other conditions that exist in each application.

RTD's shall be of nickel or platinum construction and have a base resistance of 1000 Ω at 70°F and 77°F respectively. 100 Ω platinum RTD's are acceptable if used with temperature transmitters.

The temperature sensing device used must be compatible with the DDC controllers used on the project.

RTD

Accuracy (Room Sensor Only)	minimum $\pm 1.0^{\circ}\text{F}$
Accuracy (Averaging)	minimum $\pm 1.2^{\circ}\text{F}$
Accuracy (Other than Room Sensor or Averaging)	minimum $\pm 0.65^{\circ}\text{F}$

Range	minimum -40 - 220°F
Thermistor	
Accuracy (All)	minimum $\pm 0.36^\circ\text{F}$
Range	minimum -30 - 230°F
Heat Dissipation Constant	minimum 2.7 mW/°C
Temperature Transmitter	
Accuracy	minimum $\pm 0.1^\circ\text{F}$ or $\pm 0.2\%$ of span
Output	4-20 mA

Provide limited range or extended range sensors if required to sense the range expected for a respective point. Use RTD type sensors for extended ranges beyond -30 to 230°F. If RTD's are incompatible with DDC controller direct temperature input use temperature transmitters in conjunction with RTD's.

Use wire size appropriate to limit temperature offset due to wire resistance to 1.0°F. If offset is greater than 1.0°F due to wire resistance, use temperature transmitter. If feature is available in DDC controller, compensate for wire resistance in software input definition.

Provide sensors in occupied spaces with brushed aluminum or brushed nickel covers unless otherwise noted or features specified will not allow for this. Terminal unit sensors with setpoint adjustments and digital displays may use plastic covers. Provide information to the AE on sensor colors offered by the manufacturer and obtain approval on what color should be provided on the project.

Terminal unit sensors shall be provided with digital displays that indicate room temperature and setpoint and have a manual occupancy override and indication of occupancy status. Provide setpoint adjustment as specified in the DDC Input/Output Summary Table and sequence of operation. Range adjustment shall be set and controlled at the main control interface and not at the terminal unit sensor.

Use averaging elements on duct sensors when the ductwork is ten square feet or larger. All mixed air and heating coil discharge sensors shall have averaging elements regardless of duct size.

In piping systems use temperature sensors with separable wells designed to be used with temperature element.

PRESSURE TRANSDUCERS (AIR)

Provide pressure transducers specified below for the following applications:

- Duct static pressure applications where setpoints are specified to control at greater than 0.1" w.c.
- Pitot type fan inlet air flow stations.
- Terminal unit air flow measurement regardless of the minimum velocity pressure unless otherwise noted in the contract documents.

Manufacturers: Mamac Systems, Setra, and Veris Industries.

Provide a transmitter that operates on the capacitance principle and is capable of sensing low positive, negative or differential pressures. Transmitter shall have a minimum of three pressure ranges adjustable by an onboard switch or jumper. Size the transmitter where the middle or high range is suitable for the application. Use a bi-directional transmitter for applications that may have both positive and negative pressure excursions. Transmitter shall be provided with an integral four-digit display of the pressure sensed.

Accuracy (including non-linearity and hysteresis)	± 1% FS
Compensated Temperature Range	32°-140° F
Temperature Effect	0-1"wc Range .09% FS/°F; >1"wc Range .02% FS/°F
Output	4-20 MA
Load Impedance (smallest maximum acceptable)	800 Ω max.
Operating Temperature	32°-140° F

Pressure transducers used for supply VAV box flow applications do not need to have adjustable pressure ranges or integral display.

Provide pressure transducers specified below for the following applications:

- Duct static pressure applications where setpoints are specified to control at 0.1" w.c. or lower.
- All duct mounted pitot type air flow stations.
- Space/building static control or monitoring.

Manufacturers: Paragon Controls MicroTrans, Air Monitor Veltron DPT2500 Plus, or approved equal.

The airflow transducer shall provide noise filtration and automatic auto-zeroing. The automatic zeroing circuit shall be capable of maintaining the transducer output to within ±0.25% of operating span. The transducer output shall be locked and maintained at the last given output value during the automatic zeroing period so as not to interrupt the automatic control process. Use a bi-directional transmitter for applications that may have both positive and negative pressure excursions. Transmitter shall be provided with an integral four-digit display of the pressure sensed.

Transducer Span: <2 times the design velocity pressure at maximum flow, single range
Accuracy: ±0.25% of full scale, including non-linearity, hysteresis, deadband, and non-repeatability
Temperature Effect: ±0.15% of full scale/°F
Response: 0.5 sec. for 98% of full span change
Overpressure: 5 PSIG Proof
Power: 24VAC/VDC
Analog Output: 0-5VDC, 0-10VDC, or 4-20mA field adjustable
Auto Zero Frequency: every 1 to 24 hours on 1 hour intervals

For space or building static pressure monitoring, use Vaisala model SPH10 Static Pressure Head, or approved equal for outside air reference. Mount in location shown on plans or approved by AE.

PRESSURE TRANSDUCERS (LIQUID/STEAM)

Provide a transmitter that utilizes capacitive or thin film strain gauge sensing. Provide for an analog gauge piped in parallel with the transducer. Gauge shall meet specifications as specified in Section 23 05 15. Coordinate with mechanical contractor to provide and install this gauge. For differential pressure applications provide with bypass valve manifold assembly with valved venting capability.

Accuracy (including non-linearity and hysteresis)	± 0.5% FS
Compensated Temperature Range	32°-150° F
Temperature Effect (over compensated range)	0.03%/°F;
Output	4-20 MA
Load Impedance (smallest maximum acceptable)	600 Ω Minimum
Operating Temperature	0°-175° F

Hysteresis

0.75% of span

PART 3 - EXECUTION

INSTALLATION

Install system with trained mechanics and electricians employed by the control equipment manufacturer or an authorized representative of the manufacturer. Where installing contractor is an authorized representative of the control manufacturer, such authorization shall have been in effect for a period of no less than three years.

Install all control equipment, accessories, wiring, and piping in a neat and workmanlike manner. All control devices must be installed in accessible locations. This contractor shall verify that all control devices furnished under this Section are functional and operating the mechanical equipment as specified in Section 23 09 93.

Label all control devices with the exception of dampers, valves, and terminal unit devices with permanent printed labels that correspond to control drawings. Temperature control junction and pullboxes shall be identified utilizing spray painted green covers. Other electrical system identification shall follow the 26 05 53 specification.

All control devices and electrical boxes mounted on insulated ductwork shall be mounted over the insulation. Provide mounting stand-offs where necessary for adequate support. Cutting and removal of insulation to mount devices directly on ductwork is not acceptable. This contractor shall coordinate with the insulation contractor to provide for continuous insulation of ductwork.

Mounting of electrical or electronic devices shall be protected from weather if the building is not completely enclosed. This Contractor shall be solely responsible for replacing any equipment that is damaged by water that infiltrates the building if equipment is installed prior to the building being enclosed.

Provide all electrical relays and wiring, line and low voltage, for control systems, devices and components. Install all high voltage and low voltage wiring (includes low voltage cable) in metal conduit, Electrical Non-metallic Tubing (ENT), or Electrical Metallic Tubing (EMT), as scheduled below and hereafter referred to generically as conduit. See Wire and Air Piping Conduit Installation Schedule below for specific conduit or tubing to be used. All conduit must be installed in accordance with electrical sections (Division 26) of this specification and the National Electrical code.

Conduit shall be a minimum of 1/2 " for low voltage control provided the pipe fill does not exceed 40%.

Minimum low voltage wiring gauge to be 18 AWG for outputs and 20 AWG for inputs. All low voltage wiring to be stranded.

Low voltage wiring can be run without conduit above accessible lay-in tile ceilings. All wiring in mechanical rooms, above inaccessible hard ceilings, exterior locations, and in any exposed areas, and in all other locations should be in conduit. Wire for wall sensors must be run in conduit. Wiring for radiation valves shall be run in conduit where routed through walls.

Where wiring is installed free-air, installation shall consider the following:

- Wiring shall utilize the cable tray wherever possible.
- Wiring shall run at right angles and be kept clear of other trades work.

- Wiring shall be supported utilizing "J" or "Bridal-type" steel mounting rings anchored to ceiling concrete, piping supports, walls above ceiling or structural steel beams. Mounting rings shall be of open design (not a closed loop) to allow additional wire to be strung without being threaded through the ring. For mounting rings that do not completely surround the wire, attach the wire to the mounting ring with a strap.
- Supports shall be spaced at a maximum 4-foot interval unless limited by building construction. If wiring "sag" at mid-span exceeds 4-inches; another support shall be used.
- Wiring shall never be laid directly on the ceiling grid or attached in any manner to the ceiling grid wires.
- Wall penetrations shall be sleeved.

Wiring shall not be attached to existing cabling, existing tubing, plumbing or steam piping, ductwork, ceiling supports or electrical or communications conduit.

Provide communication trunk wiring to integrated devices (i.e. VFD's, Flow Meters, Chillers, Lighting Panels, Electrical Meters, etc.) that are specified to be connected to the building automation system. Communication trunk wiring shall be as required by the equipment specified under the 23 09 23 Sections and shall be routed to the DDC panel designated for that equipment as shown on the plans or the closest DDC panel if not designated. If communication trunks required daisy chained style wiring, provide two communication cables.

Install "hand/off/auto" selector switches on systems where automatic interlock controls are specified and "hand/off/auto" selector switches are not supplied with the equipment controlled. Control panel power will not be required for "hand" switch to operate. When switch is in "hand" position, allow manual operation of the selected device without operating the interlocked motors but allowing all unit safety devices to stay in the circuit.

All pneumatic tubing and electrical wiring are to be permanently tagged or labeled within one inch of terminal strip with a numbering system to correspond with the "Record Drawings".

After completion of installation, test and adjust control equipment. Submit data showing set points and final adjustments of controls.

CONTROL AND SMOKE DAMPERS

All control dampers furnished by the control manufacturer are to be installed by the Mechanical Contractor under the coordinating control and supervision of the Control Contractor in locations shown on plans or where required to provide specified sequence of control.

Coordinate installation with the sheet metal installer to obtain smooth duct transitions where damper size is different than duct size. Blank off plates will not be accepted.

Each operator shall serve a maximum damper area of 36 square feet. Where larger dampers are used, provide multiple operators.

ROOM THERMOSTATS AND TEMPERATURE SENSORS

Check and verify location of thermostats, humidistats, and other exposed control sensors with plans and room details before installation. Locate room thermostats and sensors 48 inches above floor. Align with light switches and humidistats. For drywall installations, thermostat mounting shall use a back-box attached to a wall stud, drywall anchors are not acceptable.

Any room thermostats or sensors mounted on an exterior wall shall be mounted on a thermally insulated sub-base. Subbase to provide a minimum of one half inch of insulation.

Where thermostats or sensors are mounted on exterior walls or in any location where air transfer will affect the measured temperature or humidity seal the conduit and any other opening that will effect the measurement.

Thermostat and temperature sensor range shall be set and adjustable be the Building Automation system.

DIFFERENTIAL PRESSURE SWITCHES

Provide for each fan or pump specified, or shown on point list. Provide shutoff valves at piping takeoff points. Readjust pressure and/or differential setpoints for proper operation after final balancing is completed.

END OF SECTION

**SECTION 23 11 00
FACILITY FUEL PIPING**

PART 1 - GENERAL

SCOPE

This section contains specifications for fuel pipe and fuel pipe fittings for this project. Included are the following topics:

PART 1 - GENERAL

- Scope
- Related Work
- Reference
- Reference Standards
- Shop Drawings
- Quality Assurance
- Delivery, Storage, and Handling
- Design Criteria
- Welder Qualifications
- Natural Gas Service

PART 2 - PRODUCTS

- Natural Gas
- Vents and Relief Valves
- Unions and Flanges

PART 3 - EXECUTION

- Preparation
- Erection
- Welded Pipe Joints
- Threaded Pipe Joints
- Natural Gas
- Vents and Relief Valves
- Unions and Flanges
- Piping System Leak Tests
- Piping System Test Report

RELATED WORK

Section 23 05 29 - Hangers and Supports for Mechanical Piping and Equipment

Section 23 05 23 - General-Duty Valves for HVAC Piping

REFERENCE

Applicable provisions of Division 1 govern work under this section.

REFERENCE STANDARDS

ANSI B16.3	Malleable Iron Threaded Fittings
ASTM A53	Pipe, Steel, Black and Hot-Dipped, Zinc Coated Welded and Seamless
ASTM A234	Pipe Fittings of Wrought Carbon Steel and Alloy Steel for Moderate and Elevated Temperatures

SHOP DRAWINGS

Refer to Division 1 - General Requirements, Administrative Requirements.

Contractor shall submit schedule indicating the ASTM specification number of the pipe being proposed along with its type and grade and sufficient information to indicate the type and rating of fittings for each service.

TYPE E OR S STEEL PIPE:

Mill certification papers, also known as material test reports, for the pipe furnished for this project, in English. Heat numbers on these papers to match the heat numbers stenciled on the pipe. Chemical analysis indicated on the mill certification papers to meet or exceed the requirements of the referenced ASTM specification.

QUALITY ASSURANCE

Order all Type E and Type S steel pipe with heat numbers rolled, stamped, or stenciled to each length or each bundle, depending on the size of the pipe, and in accordance with the appropriate ASTM specification.

Any installed material not meeting the specification requirements must be replaced with material that meets these specifications without additional cost to the Owner.

DELIVERY, STORAGE, AND HANDLING

Promptly inspect shipments to insure that the material is undamaged and complies with specifications.

Cover pipe to eliminate rust and corrosion while allowing sufficient ventilation to avoid condensation. Do not store materials directly on grade. Protect pipe, tube, and fitting ends so they are not damaged. Where end caps are provided or specified, take precautions so the caps remain in place.

Offsite storage agreements will not relieve the contractor from using proper storage techniques.

Storage and protection methods must allow inspection to verify products.

DESIGN CRITERIA

Use only new material, free of defects, rust and scale, and meeting the latest revision of ASTM specifications as listed in this specification.

Construct all piping for the highest pressures and temperatures in the respective system in accordance with ANSI B31, but not less than 125 psig unless specifically indicated otherwise.

Non-metallic piping will be acceptable only for the services indicated. It will not be acceptable in occupied spaces and ventilation plenum spaces, including plenum ceilings.

Where weld fittings or mechanical grooved fittings are used, use only long radius elbows having a centerline radius of 1.5 pipe diameters.

Where ASTM A53 grade A pipe is specified, ASTM A53 grade B pipe may be substituted at Contractor's option. Where the grade or type is not specified, Contractor may choose from those commercially available.

WELDER QUALIFICATIONS

Before any metallic welding is performed, Contractor to submit his Standard Welding Procedure Specification together with the Procedure Qualification Record as required by Section IX of the ASME Boiler and Pressure Vessel Code and/or the National Certified Pipe Welding Bureau.

Before any polyethylene fusion welding is performed, Contractor to submit certification that the welders to be used on this project have successfully demonstrated proper welding procedures in accordance with the Code of Federal Regulations, Title 49, Part 192, Section 192.285.

The A/E reserves the right to test the work of any welder employed on the project, at the Contractor's expense. If the work of the welder is found to be unsatisfactory, the welder shall be prevented from doing further welding on the project.

NATURAL GAS SERVICE

Owner to pay and provide natural gas service to the building. Contractor shall provide gas load and exact meter location requirements to the owner for gas service installation. Temporary gas service remains the responsibility of the Contractor.

PART 2 - PRODUCTS

NATURAL GAS(Systems)

2" and Smaller: ASTM A53, type E or S, standard weight (schedule 40) black steel pipe with ASTM A197/ANSI B16.3 class 150 black malleable iron threaded fittings or ASTM A234 grade WPB/ANSI B16.9 standard weight, seamless, carbon steel weld fittings.

2-1/2" and Larger: ASTM A53, type E or S, standard weight black steel pipe with ASTM A234 grade WPB/ANSI B16.9 standard weight, seamless, carbon steel weld fittings.

VENTS AND RELIEF VALVES

Use pipe and pipe fittings as specified for the system to which the relief valve or vent is connected.

UNIONS AND FLANGES

2" and Smaller: ASTM A197/ANSI B16.3 malleable iron unions with brass seats. Use black malleable iron on black steel piping and galvanized malleable iron on galvanized steel piping. Use unions of a pressure class equal to or higher than that specified for the fittings of the respective piping service but not less than 250 psi.

2-1/2" and Larger: ASTM A181 or A105, grade 1 hot forged steel flanges of threaded, welding and of a pressure class compatible with that specified for valves, piping specialties and fittings of the respective piping service. Flanges smaller than 2-1/2" may be used as needed for connecting to equipment and piping specialties. Use raised face flanges ANSI B16.5 for mating with other raised face flanges on equipment with flat ring or full face gaskets. Use ANSI B16.1 flat face flanges with full face gaskets for mating with other flat face flanges on equipment.

PART 3 - EXECUTION

PREPARATION

Remove all foreign material from interior and exterior of pipe and fittings.

ERECTION

Install all piping parallel to building walls and ceilings and at heights which do not obstruct any portion of a window, doorway, stairway, or passageway. Where interferences develop in the field, offset or reroute piping as required to clear such interferences. In all cases, consult drawings for exact location of pipe spaces, ceiling heights, door and window openings, or other architectural details before installing piping.

Provide anchors, expansion joints, swing joints and/or expansion loops so that piping may expand and contract without damage to itself, equipment, or building.

Mitered ells, notched tees, and orange peel reducers are not acceptable. On threaded piping, bushings are not acceptable.

"Weldolets" and "Threadolets" may be used for branch takeoffs up to one-half (1/2) the diameter of the main.

Do not route piping through transformer vaults or above transformers, panelboards, or switchboards, including the required service space for this equipment, unless the piping is serving this equipment

Install all valves, and piping specialties, including items furnished by others, as specified and/or detailed. Make connections to all equipment installed by others where that equipment requires the piping services indicated in this section.

WELDED PIPE JOINTS

Make all welded joints by fusion welding in accordance with ASME Codes, ANSI B31, and State Codes where applicable.

Contractor will ensure that these steps are followed where pipe sections will be joined by welding:

1. Cleaning – Welding surfaces will be clean and free of defects.
2. Alignment – Inside diameter of piping components will be aligned as accurately as possible. Internal misalignment shall not exceed 1/16”.
3. Spacing – Pipe sections will be spaced to allow deposition of weld filler material through the entire weld joint thickness.
4. Girth Butt Welds:
 - a. Girth butt welds shall be complete penetration welds.
 - b. Concavity will not exceed 1/32”
 - c. Under cuts will not exceed 1/32”
 - d. As welded surfaces are permitted however surfaces will be free from coarse ripples, grooves, abrupt ridges and valleys.

Electrodes shall be Lincoln, or approved equal, with coating and diameter as recommended by the manufacturer for the type and thickness of work being done.

THREADED PIPE JOINTS

Use a Teflon based thread lubricant or Teflon tape when making joints; no hard setting pipe thread cement or caulking will be allowed.

NATURAL GAS

Pitch horizontal piping down 1" in 60 feet in the direction of flow. Install a 4" minimum depth dirt leg at the bottom of each vertical run and at each appliance. When installing mains and branches, cap gas tight each tee or pipe end which will not be immediately extended. All branch connections to the main shall be from the top or side of the main.

Do not install gas pipe in a ventilation air plenum.

If an above ground vent terminates in an area subject to snow accumulation, terminate the line at least five feet above grade.

Install a shut off valve at each appliance. Provide a valved connection at the main for equipment and appliances furnished by others.

Piping through a roof shall be run through an approved roof penetration with flashing and counter flashing.

Each gas pressure reducing valve vent and relief valve vent shall be run separately to a point outside of the building, terminated with a screened vent cap, and located according to gas utility regulations.

Clean all welded piping before all regulators and control valves. Test by placing target cloth over piping and blow with compressed air. Clean piping until target cloth is clean and free of debris.

VENTS AND RELIEF VALVES

Install vent and relief valve discharge lines as indicated on the drawings, as detailed, and as specified for each specific valve or piping specialty item. In no event is a termination to occur less than six feet above a roof line.

UNIONS AND FLANGES

Install a union or flange, as required, at each automatic control valve and at each piping specialty or piece of equipment which may require removal for maintenance, repair, or replacement. Where a valve is located at a piece of equipment, locate the flange or union connection on the equipment side of the valve. Concealed unions or flanges are not acceptable.

PIPING SYSTEM LEAK TESTS

Verify that the piping system being tested is fully connected to all components and that all equipment is properly installed, wired, and ready for operation. If required for the additional pressure load under test, provide temporary restraints at expansion joints or isolate them during the test. Verify that hangers can withstand any additional weight load that may be imposed by the test.

Provide all piping, fittings, blind flanges, and equipment to perform the testing.

Conduct pressure test with test medium of air or water unless specifically indicated. Minimum test time is indicated in the table below; additional time may be necessary to conduct an examination for leakage. If leaks are found, repair the area with new materials and repeat the test; caulking will not be acceptable.

Do not insulate pipe until it has been successfully tested.

For hydrostatic tests, use clean water and remove all air from the piping being tested by means of air vents or loosening of flanges/unions. Measure and record test pressure at the high point in the system.

For air tests, gradually increase the pressure to not more than one half of the test pressure; then increase the pressure in steps of approximately one-tenth of the test pressure until the required test pressure is reached. Examine all joints and connections with a soap bubble solution or equivalent method. The piping system exclusive of possible localized instances at pump or valve packing shall show no evidence of leaking. After testing is complete, slowly release the pressure in a safe manner.

Measure natural gas system test pressure with a water manometer or an equivalent device calibrated in increments not greater than 0.1 inch water column. System will not be approved until it can be demonstrated that there is no measurable loss of test pressure during the test period.

<u>System</u>	<u>Pressure</u>	<u>Medium</u>	<u>Duration</u>
Natural gas	100 psig	Air	24 hr

On piping that can not be tested because of connection to an active line, provide temporary blind flanges and hydrostatically test new section of piping. After completion of test, remove temporary flanges and make final connections to piping. Die penetrate test pass weld or x-ray the piping that was not hydrostatically tested up to the active system.

END OF SECTION

PIPING SYSTEM TEST REPORT

Date: _____
Submitted: _____

Project Name: Dane County Highway York Satellite Building _____

Location: _____ Project No: _____

Contractor: _____

- | | | |
|---|--|--------------------------------------|
| <input type="checkbox"/> HVAC | <input type="checkbox"/> Refrigeration | <input type="checkbox"/> Controls |
| <input type="checkbox"/> Power Plant | <input type="checkbox"/> Plumbing | <input type="checkbox"/> Sprinkler |
| Test Medium: <input type="checkbox"/> Air | <input type="checkbox"/> Water | <input type="checkbox"/> Other _____ |

Test performed per specification section No. _____

Specified Test Duration _____ Hours Specified Test Pressure _____ PSIG

System Identification: _____

Describe Location: _____

Test Date: _____	
Start Test Time: _____	Initial Pressure: _____ PSIG
Stop Test Time: _____	Final Pressure: _____ PSIG

Tested By: _____

Witnessed By: _____

Title: _____

Title: _____

Signed: _____

Signed: _____

Date: _____

Date: _____

Comments: _____

**SECTION 23 31 00
HVAC DUCTS and CASINGS**

PART 1 - GENERAL

SCOPE

This section includes specifications for all duct systems used on this project. Included are the following topics:

PART 1 - GENERAL

- Scope
- Related Work
- Reference
- Reference Standards
- Quality Assurance
- Shop Drawings
- Design Criteria

PART 2 - PRODUCTS

- General
- Materials
- Low Pressure Ductwork (Maximum 2 inch pressure class)
- Above Ground Vehicle Exhaust Duct
- Moisture Laden Exhaust
- Duct Sealant
- Gaskets

PART 3 - EXECUTION

- Installation
- Low Pressure Duct (Maximum 2 inch pressure class)
- Cleaning
- Leakage Test
- Structural Test

RELATED WORK

- 23 07 00 – HVAC Duct Insulation
- 23 33 00 – Air Duct Accessories
- 23 05 93 - Testing, Adjusting, and Balancing for HVAC

REFERENCE

Applicable provisions of Division 1 govern work under this Section.

REFERENCE STANDARDS

ANSI SS-EN 485-2	Aluminum and Aluminum Alloys-Sheet, Strip and Plate-Part 2: Mechanical Properties
ASTM B209	Specification for Aluminum and Aluminum-Alloy Sheet and Plate
ASTM A90	Test Method for Weight of Coating on Zinc-Coated (Galvanized) Iron or Steel Articles
ASTM A167	Specification for Stainless and Heat-Resisting Chromium-Nickel Steel Plate, Sheet, and Strip
ASTM A623	Standard Specification for Steel Sheet, Zinc-Coated (Galvanized) by the Hot-Dip Process
ASTM A527	Specification for General Requirements for Steel Sheet, Zinc-Coated (Galvanized) by the Hot-Dip Process, Lock-Forming Quality
ASTM 924	Standard Specification for General Requirements for Sheet Steel, Metallic-coated by the Hot-dip Method
ASTM C 1071	Specification for Fibrous Glass Duct Lining Insulation
ASTM C 411	Test Method for Hot Surface Performance of High Temperature Thermal
	Insulation
ASTM E 84	Test Method for Surface Burning Characteristics of Building Materials
ASTM C 1338	Test Method for Determining Fungal Resistance of Insulation Materials and Facings
ASTM G 21	Standard Practice for Determining Resistance of Synthetic Polymeric Materials to

ASTM C 916	Fungi
90A	Standard Specification for Adhesives for Duct Thermal Insulation
UL 181	NFPA Standard for the Installation of Air Conditioning and Ventilating Systems
NAIMA	Standard for Safety for Factory Made Air Ducts and Air Connectors.
	Fibrous Glass Duct Liner Standard

QUALITY ASSURANCE

Refer to division 1, General Conditions, Equals and Substitutions.

SHOP DRAWINGS

Refer to division 1, General Conditions, Submittals.

Include manufacturer's data and/or Contractor data for the following:

- Fabrication and installation drawings.
- Schedule of duct systems including material of construction, gauge, pressure class, system class, method of reinforcement, joint construction, fitting construction, and support methods, all with details as appropriate.
- Duct sealant and gasket material.
- Duct liner including data on thermal conductivity, air friction correction factor, and limitation on temperature and velocity.

DESIGN CRITERIA

Construct all ductwork to be free from vibration, chatter, objectionable pulsations and leakage under specified operating conditions.

Use material, weight, thickness, gauge, construction and installation methods as outlined in the following SMACNA publications, unless noted otherwise:

- HVAC Duct Construction Standards, Metal and Flexible, 2nd Edition, 1995
- HVAC Air Duct Leakage Test Manual, 1st Edition, 1985
- HVAC Systems - Duct Design, 3rd Edition, 1990
- Rectangular Industrial Duct Construction Standard, 1st Edition, 1980
- Round Industrial Duct Construction Standards, 2nd Edition, 1999
- Thermoplastic Duct (PVC) Construction Manual, 2nd Edition, 1995
- Round Industrial Duct Construction Standards, 2nd Edition, 1999
- Rectangular Industrial Duct Construction Standards, 1st Edition, 1980

Use products which conform to NFPA 90A, possessing a flame spread rating of not over 25 and a smoke developed rating no higher than 50.

DELIVERY, STORAGE AND HANDLING

Promptly inspect shipments to ensure that Ductwork is undamaged and complies with the specification.

Protect Ductwork against damage.

Protect Ductwork by storing inside or by durable, waterproof, above ground packaging. Do not store material on grade. Protect Ductwork from dirt, dust, construction debris and foreign material. Where end caps/packaging are provided, take precautions so caps/packaging remain in place and free from damage.

Offsite storage agreements do not relieve the contractor from using proper storage techniques.

Storage and protection methods must allow inspection to verify products.

PART 2 - PRODUCTS

GENERAL

All sheet metal used for construction of duct shall be 24 gauge or heavier except for round and spiral ductwork and spiral duct take-offs 12" and below may be 26 gauge where allowed in SMACNA HVAC Duct Construction Standards, Metal and Flexible, 2nd Edition, 1995.

Duct sizes indicated on plans are net inside dimensions; where duct liner is specified, dimensions are net, inside of liner.

DUCTWORK PRESSURE CLASS

Minimum acceptable duct pressure class, for all ductwork except transfer ductwork, is 2 inch W.G. positive or negative, depending on the application. Transfer ductwork minimum acceptable duct pressure class is 1 inch W.G. positive or negative, depending on the application. Duct system pressure classes not indicated on the drawings to be as follows:

MATERIALS

GALVANIZED STEEL SHEET:

Use ASTM A 653 galvanized steel sheet of lock forming quality. Galvanized coating to be 1.25 ounces per square foot, both sides of sheet, G90 in accordance with ASTM A90.

ALUMINUM SHEET:

Use ANSI/ASTM B209 aluminum sheet, alloy 3003H-14, capable of double seaming without fracture.

STAINLESS STEEL SHEET:

Use ASTM A167, Type 304 or 316 stainless steel sheet as specified, 316L if welded ductwork, with No. 2B finish for concealed work and No. 3 finish for exposed work.

LOW PRESSURE DUCTWORK (Maximum 2 inch pressure class)

Fabricate and install ductwork in sizes indicated on the drawings and in accordance with SMACNA recommendations, except as modified below.

Construct so that all interior surfaces are smooth. Use slip and drive or flanged and bolted construction when fabricating rectangular ductwork. Use spiral lock seam construction when fabricating round spiral ductwork. Sheet metal screws may be used on duct hangers, transverse joints and other SMACNA approved locations if the screw does not extend more than 1/2 inch into the duct.

Use elbows and tees with a center line radius to width or diameter ratio of 1.5 wherever space permits. When a shorter radius must be used due to limited space, install single wall sheet metal splitter vanes in accordance with SMACNA publications, Type RE 3. Where space will not allow and the C value of the radius elbow, as given in SMACNA publications, exceeds 0.31, use rectangular elbows with turning vanes as specified in Section 15820. Square throat-radius heel elbows will not be acceptable. Straight taps or bullhead tees are not acceptable.

Where rectangular elbows are used in supply, return and general exhaust ductwork, provide turning vanes in accordance with Section 23 33 00.

Provide expanded take-offs or 45 degree entry fittings for branch duct connections with branch ductwork airflow velocities greater than 700 fpm. Square edge 90-degree take-off fittings or straight taps will not be accepted.

Button punch snaplock construction will not be accepted on aluminum ductwork.

Round ducts may be substituted for rectangular ducts if sized in accordance with ASHRAE table of equivalent rectangular and round ducts. No variation of duct configuration or sizes permitted except by written permission of the Architect/Engineer.

Round snap lock duct is acceptable on duct up to 12" diameter, duct larger than 14" and larger shall be spiral seam. Exposed round duct shall be spiral seam.

Increase duct sizes gradually, not exceeding 15 degrees divergence wherever possible. Divergence upstream of equipment shall not exceed 30 degrees; convergence downstream shall not exceed 45 degrees.

ABOVE GROUND VEHICLE EXHAUST DUCT

Above ground vehicle exhaust duct shall be spiral galvanized steel duct constructed to 10" pressure class SMACNA standards.

Only spiral helical wound duct shall be used, no snap lock duct allowed. Elbows shall be constructed of 1 gauge heavier material.

MOISTURE LADEN EXHAUST DUCT CONSTRUCTION

Fabricate and install ductwork in sizes indicated on the drawings and in accordance with SMACNA recommendations, except as indicated below.

Use 2" pressure class aluminum duct on moisture laden exhaust duct. Seal all joints with water proof mastic or duct sealer.

Use elbows and tees as specified for the appropriate duct pressure class.

DUCT SEALANT

Manufacturer: 3M 800, 3M 900, H.B. Fuller/Foster, Hardcast, Hardcast Peal & Seal, Lockformer cold sealant, Mon-Eco Industries, United Sheet Metal, or approved equal. Silicone sealants are not allowed in any type of ductwork installation.

Install sealants in strict accordance with manufacturer's recommendations, paying special attention to temperature limitations. Allow sealant to fully cure before pressure testing of ductwork, or before startup of air handling systems.

GASKETS

2 INCH PRESSURE CLASS AND LOWER:

Soft neoprene or butyl gaskets in combination with duct sealant for flanged joints.

PART 3 - EXECUTION

INSTALLATION

Verify dimensions at the site, making field measurements and drawings necessary for fabrication and erection. Check plans showing work of other trades and consult with Architect in the event of any interference.

Make allowances for beams, pipes or other obstructions in building construction and for work of other contractors. Transform, divide or offset ducts as required, in accordance with SMACNA HVAC Duct Construction Standards, Figure 2-7, except do not reduce duct to less than six inches in any dimension and do not exceed an 8:1 aspect ratio. Where it is necessary to take pipes or similar obstructions through ducts, construct easement as indicated in SMACNA HVAC Duct Construction Standards, Figure 2-8, Fig. E. In all cases, seal to prevent air leakage. Pipes or similar obstructions may not pass through high pressure or fume exhaust ductwork.

Test openings for test and balance work will be provided under Section 15.

Provide frames constructed of angles or channels for coils, filters, dampers or other devices installed in duct systems, and make all connections to such equipment including equipment furnished by others. Secure frames with gaskets and screws or nut, bolts and washers.

Install duct to pitch toward outside air intakes and drain to outside of building. Solder or seal seams to form watertight joints.

Where two different metal ducts meet, the joint shall be installed in such a manner that metal ducts do not contact each other by using proper seal or compound.

Install all motor operated dampers and connect to or install all equipment furnished by others. Blank off all unused portions of louvers, as indicated on the drawings, with 1-1/2 inch board insulation with galvanized sheet metal backing on both sides.

Do not install ductwork through dedicated electrical rooms or spaces unless the ductwork is serving this room or space.

Locate ducts with sufficient space around equipment to allow normal operating and maintenance activities.

Provide adequate access to ductwork for cleaning purposes.

Provide temporary capping of ductwork openings to prevent entry of dirt, dust and foreign material.

Protect diffusers, registers and grilles with plastic wrap or some other approved form of protection to maintain dirt and dust free and to prevent entry of dirt, dust and foreign material into the Ductwork.

Install prefabricated grease ductwork assemblies in accordance with manufacturer requirements and NFPA 96.

During construction provide temporary closures of metal or taped polyethylene on open ductwork to prevent construction dust from entering ductwork system.

Round duct passing through fire rated construction shall be a minimum of 26ga sheet metal.

DUCTWORK SUPPORT

Support ductwork in accordance with SMACNA HVAC Duct Construction Standards, Figure 4-4.

LOW PRESSURE DUCT (Maximum 2 inch pressure class)

Seal all duct, with the exception of transfer ducts, in accordance with SMACNA seal class listed in specifications.

Install a manual balancing damper in each branch duct and for each diffuser or grille. The use of splitter dampers, extractors, or grille face dampers will not be accepted for balancing dampers.

Hangers must be wrapped around bottom edge of duct and securely fastened to duct with sheet metal screws or pop rivets. Trapeze hangers may be used at contractor's option.

EXHAUST DUCT (Moisture laden air)

Pitch duct to drain back to equipment or exhaust grille.

Provide water tight drain pan at low points or at locations where moisture may collect. Pipe drain pan to nearest floor drain.

EXHAUST DUCT Vehicle exhaust

Provide blast gate type balancing dampers. All branch takeoffs shall be made by 45degree saddles or taps in the direction of flow. All elbow shall have a centerline radius of 2 times the diameter

CLEANING

Remove all dirt and foreign matter from the entire duct system and clean diffusers, registers, grilles and the inside of air-handling units before operating fans.

Protect equipment and ductwork that may be operated during construction with MERV13 filters on all return connections to the unit. If filters are not used during construction clean duct systems with high power vacuum machines where systems have been used for temporary heat, air-conditioning, or ventilation purposes during construction.

LEAKAGE TEST

Test all ductwork in accordance with test methods described in Section 5 of SMACNA HVAC Air Duct Leakage Test Manual. Do not insulate ductwork until it has been successfully tested. Test pressure shall be equal to the duct pressure class.

If excessive air leakage is found locate leaks, repair the duct in the area of the leak, seal the duct, and retest.

Leakage rate shall not exceed more than 5% of the system air quantity for low pressure ductwork, determined in accordance with Appendix C of the SMACNA HVAC Air Duct Leakage Test Manual.

Leakage rate shall not exceed more than 1% of the system air quantity for high pressure ductwork, determined in accordance with Appendix C of the SMACNA HVAC Air Duct Leakage Test Manual.

Leakage test for ductwork designed to 2"wg pressure or below may be omitted but will not relieve the contractor from duct sealing requirements.

Submit a signed report to the Architect/ Engineer indicating test apparatus used, results of the leakage test, and any remedial work required to bring duct systems into compliance with specified leakage rates.

STRUCTURAL TEST

Deflection limits shall not exceed those listed in accordance with Chapter 7 of SMACNA HVAC Duct Construction Standards, 3.0 Performance Requirements.

END OF SECTION

**SECTION 23 33 00
AIR DUCT ACCESSORIES**

PART 1 - GENERAL

SCOPE

This sections includes accessories used in the installation of duct systems. Included are the following topics:

PART 1 - GENERAL

- Related Work
- Reference
- Reference Standards
- Quality Assurance
- Shop Drawings

PART 2 - PRODUCTS

- Manual Volume Dampers
- Turning Vanes
- Fire Dampers
- Control Dampers
- Smoke Detectors
- Access Doors
- Flexible Duct
- Duct Lining
- Flashings
- Duct Flexible Connections
- Hoods for Intake and Exhaust
- Louvers Suspended
- Vehicle Exhaust Hose reels
- Flexible Vehicle Exhaust Hose

PART 3 - EXECUTION

- Manual Volume Dampers
- Turning Vanes
- Fire Dampers
- Smoke Dampers and Combination Fire/Smoke Dampers
- Control Dampers
- Smoke Detectors
- Access Doors
- Flashings
- Duct Flexible Connections
- Hoods for Intake and Exhaust
- Louvers
- Suspended Vehicle Exhaust Hose reels

RELATED WORK

23 05 29 – Hanger and Supports for HVAC Piping and Equipment
23 05 48 – Vibration and Seismic Controls for HVAC Piping and Equipment
23 31 00 – HVAC Ducts and Casings

REFERENCE

Applicable provisions of Division 1 govern work under this Section.

REFERENCE STANDARDS

NFPA 90A Standard for Installation of Air Conditioning and Ventilating Systems
SMACNA HVAC Duct Construction Standards - Metal and Flexible, 2nd Edition, 1995
UL 214

UL 555 (6th edition) Standard for Fire Dampers and Ceiling Dampers
UL 555S (4th edition) Leakage Rated Dampers for Use in Smoke Control Systems

QUALITY ASSURANCE

Refer to division 1, General Conditions, Equals and Substitutions

SHOP DRAWINGS

Refer to division 1, General Conditions, Submittals.

Submit for all accessories and include dimensions, capacities, ratings, installation instructions, and appropriate identification.

Include certified test data on dynamic insertion loss, self-noise power levels, and aerodynamic performance of sound attenuators.

Submit manufacturer's color charts where finish color is specified to be selected by the Architect/Engineer.

PART 2 - PRODUCTS

MANUAL VOLUME DAMPERS

Manufacturers: Ruskin, Vent Products, Air Balance, or approved equal.

Dampers must be constructed in accordance with SMACNA Fig. 2-12, Fig. 2-13, and notes relating to these figures, except as modified below.

Reinforce all blades to prevent vibration, flutter, or other noise. Construct dampers in multiple sections with mullions where width is over 48 inches. Use rivets or tack welds to secure individual components; sheet metal screws will not be accepted. Provide operators with locking devices and damper position indicators for each damper; use an elevated platform on insulated ducts. Provide end bearings or bushings for all volume damper rods penetrating ductwork constructed to a 3" w.c. pressure class or above.

FIRE DAMPERS

Manufacturers: Air Balance, Advanced Air, American Warming and Ventilating, Greenheck, Phillips-Aire, Prefco, Ruskin, Safe-Air or approved equal.

STATIC FIRE DAMPERS

Static fire damper assemblies must be UL 555 (6th edition) listed and labeled for static applications (where air systems do not operate during a fire) and meet requirements of NFPA 90A. Damper must be type B curtain type with blades out of the air stream; dampers with blades in the air stream will not be accepted. Damper fire rating to be compatible with the rating of the building assembly in which the damper is used.

TURNING VANES

Manufacturers: Aero Dyne, Anemostat, Barber-Colman, Hart & Cooley, or approved equal.

Construct turning vanes and runners for square elbows in accordance with SMACNA Fig. 2-3 and Fig. 2-4 except use only single width type vanes. Construct turning vanes for short radius elbows and elbows where one dimension changes in the turn in accordance with SMACNA Fig. 2-5 and Fig. 2-6.

CONTROL DAMPERS

Control dampers are specified in section 23 09 14.

SMOKE DETECTORS

Smoke detectors are furnished and wired by the Electrical Contractor and installed in ductwork by the Mechanical Contractor

ACCESS DOORS

Access door to be designed and constructed for the pressure class of the duct in which the door is to be installed. Doors in exposed areas shall be hinged type with cam sash lock. Hinges shall be steel full length continuous piano type. Doors in concealed spaces may be secured in place with cam sash latches. For both hinged and non hinged doors provide sufficient number of cam sash latches to provide air tight seal when door is closed. Do not use hinged doors in concealed spaces if this will restrict access. Use minimum 1" deep 24 gauge galvanized steel double wall access doors with minimum 24 gauge galvanized steel frames. For non-galvanized ductwork, use minimum 1" deep double wall access door with frame that shall use materials of construction identical to adjacent ductwork. Provide double neoprene gasket that shall provide seals from the frame to the door and frame to the duct. When access doors are installed in insulated ductwork or equipment provide insulated doors with insulation equivalent to what is provided for adjacent ductwork or equipment. Access doors constructed with sheet metal screw fasteners will not be accepted.

Use insulated, 1-1/2 hour UL 555 listed and labeled access doors in kitchen exhaust ducts.

FLEXIBLE DUCT

Manufacturers: Anco Products, Clevaflex, Thermafex, Flexmaster or approved equal.

Factory fabricated , UL 181 listed as a class 1 duct, and having a flame spread of 25 or less and a smoke developed rating of 50 or under in accordance with NFPA 90A.

Suitable for pressures and temperatures involved but not less than a 180°F service temperature and ±2 inch pressure class, depending on the application.

Duct to be composed of polyester film, aluminum laminate or woven and coated fiberglass fabric bonded permanently to corrosion resistant coated steel wire helix. Two-ply, laminated, and corrugated aluminum construction may also be used.

Where duct is specified to be insulated, provide a minimum fiberglass insulation blanket thickness to match connecting ducts insulation requirement with maximum thermal conductance of 0.23 K (75 degrees F.) and vapor barrier jacket of polyethylene or metalized reinforced film laminate. Maximum perm rating of vapor barrier jacket to be 0.1 perm.

DUCT LINING

Manufacturer: Manville, Owens-Corning, Knauf, or approved equal.

1 inch thick, flexible, mat faced insulation made from inorganic glass fibers bonded with a thermosetting resin with thermal conductivity of .25 Btu inch / hour sq.ft. deg F.

Meet erosion testing per UL 181 or ASTM C 1071 for 5000 fpm maximum air velocity. ASTM C 411 maximum operating temperature rating of 250 deg F. ASTM E84 flame spread less than 25 and smoke developed less than 50.

Meet requirements of ASTM C 1338 and ASTM G21 for fungi resistance.

Install liner using adhesive conforming to ASTM C 916.

FLASHINGS

Provide flashing to completely weatherproof connection of ductwork to louvers. Flashing to be constructed of material similar to louver material.

Flashing and counterflashing for roof curbs will be provided by others.

Flashing and curbs for duct and pipe penetrations of roof assemblies to be in accordance with details.

DUCT FLEXIBLE CONNECTIONS

Material to be fire retardant, be UL 214 listed, and meet the requirements of NFPA 90A.

Connections to be a minimum of 3 inches wide, crimped into metal edging strip, and air tight. Connections to have adequate flexibility and width to allow for thermal expansion/contraction, vibration of connected equipment, and other movement.

Use coated glass fiber fabric for all applications. Material for inside applications other than corrosive environments, fume exhaust, or kitchen exhaust to be double coated with neoprene, air and water tight, suitable for temperatures between -10°F and 200°F, and have a nominal weight of 30 ounces per square yard. Material used for outdoor applications other than corrosive environments, fume exhaust, or kitchen exhaust to be double coated with Hypalon, air and water tight, suitable for temperatures between -10°F and 250°F, and have a nominal weight of 26 ounces per square yard.

HOODS FOR INTAKE AND EXHAUST

Manufacturers: Acme, Ammerman, Carnes, Cook, Greenheck, Louvers and Dampers, Penn, or approved equal.

Use low silhouette type hoods.

Construct hoods of aluminum.

Provide bird screen and motor operated damper for each hood.

LOUVERS

Manufacturers: Greenheck, Ruskin or approved equal.

Similar to Greenheck Type ESD-603, extruded aluminum alloy not less than 12 gauge (.081" thick), 6063 series frame and blades, all-welded assembly, 30 degree blades with water baffle, 6 inches thick. Provide with bird screen of ½" x ½" mesh aluminum in 12 gauge aluminum frame and an aluminum sill. Locate the bird screen inside of the louver unless noted otherwise.

Louver to bear the AMCA certified ratings seal for both air performance and water penetration, having a free area not less than 50% based on a 48" x 48" section, a water penetration less than 0.1 oz/square foot under AMCA test at 1000 feet per minute, and an intake pressure drop less than 0.20 inches of water at 1000 feet per minute.

Furnish sufficient paint in the same color as the louver to paint the outer surface of panels over unused portions of louvers and to paint the interior portion of ductwork visible through the louvers.

SUSPENDED VEHICLE EXHAUST HOSE REELS

Manufacturers: Car-mon, DSP Monoxivent, NSGV, Nederman, or Plymovent

The overhead vehicle exhaust system shall include a hose reel with a direct drive planetary gear function motor – asynchronous, single phase and totally enclosed. Motor shall be operated with a wall mounted spring rocker switch.

The hose reel side mounting support frame shall be constructed of 11 gauge cold rolled steel. The side plates shall be drawn together by two heavy gauge J channel steel support braces. Each side plate shall have two pre-drilled 9/116" holes for mounting. The hose drum shall be constructed of 16 gauge cold rolled steel. The hose reel shall have a hose connection fitting allowing for use of a 6" hose. The side discharge fitting shall allow for a 6" duct connection. The hose reel shall be protected with a powder coating. Hose reel shall be equipped with a manual override on the motor.

The hose reel drum shall be supplied with a hose tracking bar to guide the hose during recoiling.

FLEXIBLE VEHICLE EXHAUST HOSE

Manufacturers: Car-mon, DSP Monoxivent, NSGV, Nederman, or Plymovent

Above Ground exhaust hose shall be a double ply hose with an inner liner ply of woven fiberglass coated silicone rubber. A helically wound spring steel wire is imbedded between the inner liner ply and an exterior ply of woven Nomex coated with silicone rubber. Exhaust hose shall be capable of handling 600°F tailpipe exhaust with an intermittent rating of 1250°F.

PART 3 - EXECUTION

MANUAL VOLUME DAMPERS

Install manual volume dampers in each branch duct and for each grille, register, or diffuser as far away from the outlet as possible while still maintaining accessibility to the damper. Install so there is no flutter or vibration of the damper blade(s).

CONCEALED DAMPER OPERATORS

Support cables with the clamps at all changes in direction and at 3' intervals. Cable must have a 4" minimum operating radius. Test individual damper operation to evaluate cable support prior to final ceiling installation. Cable may supported in EMT conduit instead of cable supports every 3'.

TURNING VANES

Install turning vanes in all rectangular, mitered elbows in accordance with SMACNA standards and/or manufacturer's recommendations.

Install single width, 2 inch radius 24gauge vanes in ducts with air velocity less than 2000 fpm. Install single vane , 4-1/2 inch radius 22gauge vanes in ducts with air velocity 2000 fpm or greater. Install vane runners in accordance with SMACNA Standards.

If duct size changes in a mitered elbow, use single wall type vanes with a trailing edge extension. If duct size changes in a radius elbow or if short radius elbows must be used, install sheetmetal turning vanes in accordance with SMACNA Figure 4-3, 4-4, and 4-5.

FIRE DAMPERS

Install dampers in strict accordance with manufacturer's installation instructions. Install damper sleeves with retaining angles on both sides of rated partition. Connections of ductwork to fire damper assemblies to be as specified on the installation instructions. Where it is necessary to set dampers out from the rated wall, install a sleeve extension encased in two hour rated fire proofing insulation. Install an access door at each fire damper, located to permit resetting the damper replacing the fusible link.

Manually test each fire damper for proper operation by removing the fusible link. Repair or replace any fire damper that does not close completely. Re-install fusible link after test.

CONTROL DAMPERS

Install dampers in locations indicated on the drawings, as detailed, and according to the manufacturer's instructions. Install blank-off plates or transitions where required for proper

mixing of airstreams in mixing plenums. Provide adequate operating clearance and access to the operator. Install an access door adjacent to each control damper for inspection and maintenance.

SMOKE DETECTORS

Wiring of detectors will be by the Electrical Contractor. Install detector and an access door at each detector location.

ACCESS DOORS

Install access doors where specified, indicated on the drawings, and in locations where maintenance, service, cleaning or inspection is required. Examples include, but are not limited to motorized dampers, fire and smoke dampers, smoke detectors, fan bearings, heating and cooling coils, filters, valves, and control devices needing periodic maintenance.

Size and numbers of duct access doors to be sufficient to perform the intended service. Minimum access door size shall be 8 x 8 inch size for hand access, 18 x 18 inch size for shoulder access, or other size as indicated. Install access doors on both inlet and outlet sides of reheat coils as well as other duct mounted coils.

FLEXIBLE DUCT

Flexible duct may only be used for final connections of air inlets and outlets at diffuser, register, and grille locations. Where flexible duct is used, it shall be the minimum length required to make the final connections, but no greater than 5 feet in length, and have no more than one (1) 90 degree bend.

Secure inner jacket of flexible duct in place with stainless steel metal band clamp. Secure insulation vapor barrier jacket in place with steel or nylon draw band. Sheetmetal screws and/or duct tape will not be accepted.

Flexible duct used to compensate for misalignment of main duct or branch duct will not be accepted.

Individual sections of flexible ductwork shall be of one piece construction. Splicing of short sections will not be accepted.

Flexible ductwork used as transfer duct shall be sized for a maximum velocity of 300 fpm.

Penetration of any partition, wall, or floor with flexible duct will not be accepted.

DUCT LINING

Apply lining to the following ductwork: No lining allowed on this project.

FLASHINGS

Flashing for roof curbs, equipment supports or rails located on roof, will be installed by others.

DUCT FLEXIBLE CONNECTIONS

Install at all duct connections to rotating or vibrating equipment, including air handling units (unless unit is internally isolated), fans, or other motorized equipment in accordance with SMACNA Figure 2-19. Install thrust restraints to prevent excess strain on duct flexible connections at fan inlets and outlets; see Related Work.

For applications in corrosive environments or fume exhaust systems, use a double layer of the Teflon₂ coated fabric when making the connector.

HOODS FOR INTAKE AND EXHAUST

Install in locations indicated on the drawings, coordinating the roof opening location with the General Contractor. Curbs are covered in Section 23 05 29.

LOUVERS

Furnish louvers to the General Contractor for mounting in exterior walls. Connect outside air intake duct to the louver, sealing all connections air and water tight.

Provide bird screen on inside of active louver area where none is provided with louvers. Where louvers are equipped with inside birdscreen, remove screen at all locations where duct connections are not made.

Install insulated metal panel on unused portion of louver. Panels must be sealed weathertight to louver assembly with flashing as required for proper drainage to outside of building. Paint outside surface of panel to match louver prior to installation. Where ductwork is visible through louver when viewed from outside the building, paint inside of duct to match louver color.

SUSPENDED VEHICLE EXHAUST HOSE REEL

Suspend vehicle exhaust hose reels from roof trusses per manufacturer's recommendations. Special attention must be taken to install reels in joist space to avoid the beam crane.

END OF SECTION

THIS PAGE INTENTIONALLY LEFT BLANK

**SECTION 23 34 00
HVAC FANS**

PART 1 - GENERAL

SCOPE

This section includes specifications for fans that are not an integral part of a manufactured device. Included are the following topics:

PART 1 - GENERAL

- Scope
- Related Work
- Reference
- Reference Standards
- Quality Assurance
- Shop Drawings
- Design Criteria

PART 2 - PRODUCTS

- General
- Power Roof Exhaust Fan
- De-stratification Fans
- Centrifugal Exhaust Fans
- Ceiling Exhaust Fans

PART 3 - EXECUTION

- Installation

RELATED WORK

Section 23 05 29 - Hangers and Supports for HVAC Piping and Equipment
Section 23 05 13 - Common Motor Requirements for HVAC Equipment
Section 23 05 48 - Vibration and Seismic Controls for HVAC Piping and Equipment

REFERENCE

Applicable provisions of Division 1 govern work under this Section.

REFERENCE STANDARDS

AMCA 203	AMCA Fan Application Manual - Troubleshooting
AMCA 210	Laboratory Method of Testing Fans for Rating
AMCA 300	Reverberant Room Method for Sound Testing of Fans
NFPA 90A	Standard for the Installation of Air Conditioning and Ventilating Systems

QUALITY ASSURANCE

Refer to division 1, General Conditions, Equals and Substitutions.

SHOP DRAWINGS

Refer to division 1, General Conditions, Submittals.

Include dimensions, capacities, fan curves, materials of construction, ratings, weights, motors and drives, sound power levels, appropriate identification and vibration isolation for all equipment. Sound power levels to be based on tests performed in accordance with AMCA Standard 300.

Submit color selection charts for equipment where applicable.

Fan curves shall indicate the relationship of CFM to static or total pressure for various fan speeds. Brake horsepower, recommended selection range, and limits of operation are to also be indicated on the curves. Indicate operating point on the fan curves at design air quantity and indicate the manufacturer's recommended drive loss factor for the specific application. Tabular fan performance data is not acceptable.

For variable air volume application, include data which indicates the effect of capacity control devices, such as inlet vanes, on performance.

DESIGN CRITERIA

Tested and certify all fans in accordance with the applicable AMCA test code.

Each fan and motor combination shall be capable of delivering 110% of air quantity scheduled at scheduled static pressure. The motor furnished with the fan shall not operate into the motor service factor when operating under these conditions.

Consider drive efficiency in motor selection according to manufacturer's published recommendation or according to AMCA Publication 203, Appendix L.

Where inlet and outlet ductwork at any fan is changed from that shown on the drawings, provide any motor, drive and/or wiring changes required due to increased static pressure or baffling necessary to prevent uneven airflow or improve mixing.

All internal insulation and other components exposed to the airstream are to meet the flame spread and smoke ratings contained in NFPA 90A.

All roof mounted equipment to be provided with curbs or equipment stands in accordance with specification in Section 23 05 29.

PART 2 - PRODUCTS

GENERAL

Use fan size, class, type, arrangement, and capacity as scheduled.

Furnish complete with motors, wheels, drive assemblies, bearings, vibration isolation devices, and accessories required for specified performance and proper operation. All single phase motors to have inherent thermal overload protection.

Provide variable pitch sheaves for drives 3 hp and smaller, fixed pitch sheaves for drives 5 hp and larger. Design all drives for 150% of motor rating.

Use OSHA approved belt guards that totally enclose the entire drive. Construct guards of expanded metal to allow for ventilation; provide tachometer openings at shaft locations.

Statically and dynamically balance all fans so they operate without objectionable noise or vibration.

Use AMCA Type A spark resistant construction for all fans handling flammable or grease laden vapors.

Provide a corrosion resistant coating on all surfaces exposed to fume and other corrosive exhaust air. Coating to be as scheduled.

POWER ROOF EXHAUST FANS

Manufacturers: Greenheck, Penn Barry, or approved equal.

Provide upblast or downblast units, as scheduled, with aluminum housing, non-overloading type centrifugal wheel, inlet cone, factory mounted and wired motor and disconnect switch, and bird screen.

Electrical Contractor will provide disconnect switches and thermal overload protection for units with three phase motors.

Upblast units to have motor, bearings, and drives completely enclosed and isolated from the exhaust air stream with ventilation provided by outside air. Units handling grease laden vapors to be U.L. listed for conveying such vapors, operating continuously at 300 degrees F.

DESTRATIFICATION FANS

Emerson-Chromalox, Envirofan, Hunter, or approved equal.

U.L. listed, all metal construction, baked enamel finish with factory standard color selected by Architect. Motors to be totally enclosed, impedance protected, single speed, of split capacitor design with permanently lubricated ball bearings.

Provide solid state variable speed controls as scheduled.

Motors to be reversible for summer/winter operation.

CENTRIFUGAL EXHAUST FANS

Manufacturers: PennBarry, Peerless, Buffalo, Champion, Chicago Blower, Greenheck, New York Blower, Twin City, or approved equal.

Construct housing of lock seam steel with angle iron frame. Use spun or die formed inlet cones to provide a streamlined flow into the wheel. Use airfoil blades welded to spun wheel cones unless otherwise indicated. Shafts shall be AISI C 1045 hot rolled steel turned, ground and polished. Shaft shall be sized for at least 125% of the fans maximum cataloged RPM.

Bearings to be self-aligning grease packed pillow block type with grease seal and external grease fittings with a minimum L50 life of 200,000 hours at the maximum cataloged operating speed. Provide each fan housing with a capped drain connection and bolted and gasketed access door for inspection of fan wheel. Unless a special coating is scheduled, paint fans with a prime coat after metal cleaning and surface preparation; apply a second coat of paint to all exterior surfaces.

Fans shall bear the AMCA Certified Ratings Seal for Sound and Air Performance.

CEILING EXHAUST FANS

Broan, Greenheck, or approved equal.

Centrifugal blower wheel, steel housing with acoustical lining, integral exhaust grille, adjustable mounting brackets to allow for any ceiling thickness, integral junction box with permanently lubricated and thermally protected motor factory wired.

Provide wall, eave, or roof discharge assembly, as indicated on the drawings. Exhaust fan shall be supplied and ducted by HVAC Contractor; Electrical contractor shall wire and hang the exhaust fan.

SIDEWALL PROPELLER FANS

Manufacturers: Greenheck, Penn, ACME or approved equal.

Constructed of steel with angle iron reinforcing and motor support frame, die formed propeller blades with a welded reinforcing gusset on the backside for added rigidity, belt or drive drive as scheduled gravity operated counter balanced backdraft damper with blade edge and jamb seals, damper operator, birdscreen, and screened inlet/fan guard. Unless a special coating is scheduled, paint fans with a prime coat after metal cleaning and surface preparation; apply a second coat of paint to all exterior surfaces.

Provide factory fabricated wall sleeves, and 45 degree wall hood.

PART 3 - EXECUTION

Install as shown on the drawings, as detailed, and according to manufacturer's installation instructions.

INSTALLATION

On units provided with a drain connection, reduce drain connection down to ½' fitting and leave open.

Install thrust restraints in accordance with the requirements of Section 23 05 48.

Contractor shall balance blade assembly of destratification fans after installation to assure stable operation.

Roof mounted Centrifugal exhaust fans shall be provided with roof rails set level on roof deck. Rails shall be flashed and roofed by roofing contractor.

END OF SECTION

THIS PAGE INTENTIONALLY LEFT BLANK

**SECTION 23 54 00
FUEL FIRED HEATING EQUIPMENT**

PART 1 - GENERAL

SCOPE

This section includes specifications for gas fired equipment that use direct and indirect gas firing to heat air. Included are the following topics:

PART 1 - GENERAL

- Scope
- Related Work
- Reference
- Reference Standards
- Quality Assurance
- Submittals
- Warranty

PART 2 - PRODUCTS

- Direct Fired Make up Air Units

PART 3 - EXECUTION

- Installation
 - Direct Fired Make Up Air Units
 - Gas & Oil Fired Unit Heaters
 - Infrared Heating Devices

RELATED WORK

Section 23 05 29 – Hangers and Support for HVAC Equipment and Piping
Section 23 05 23 – General Duty Valves for HVAC Piping
Section 23 11 00 – Facility Fuel Piping

REFERENCE

Applicable provisions of Division 1 govern work under this section.

REFERENCE STANDARDS

AGA	American Gas Association
ANSI Z83.4	Direct Gas Fired Makeup Air Heaters
ANSI Z83.6	Gas Fired Infrared Heaters
ANSI Z21.64	Direct Vent Central Furnaces
GAMA	Gas Appliance Manufacturers Association
NEC	National Electrical Code

QUALITY ASSURANCE

Refer to division 1, General Conditions, Equals and Substitutions.

SUBMITTALS

Refer to division 1, General Conditions, Submittals.

Include specific manufacturer and model numbers, equipment identification corresponding to project drawings and schedules, dimensions, capacities, materials of construction, ratings, weights, power requirements and wiring diagrams, filter information and information for all accessories.

WARRANTY

Furnace primary and secondary heat exchangers warranted for 20 years under normal use and maintenance. Remainder of furnace components warranted for 1 year from date of start up.

Gas fired unit heaters heat exchangers warranted for five years. Remainder of unit heater

components warranted for 1 year from startup.

Radiant heat tubes warranted against internal corrosion for 10 years. Remainder of infrared radiant heater components warranted for 1 year from date of startup.

Direct fired make-up air units warranted for 12 months from date of startup.

Indirect fired make-up air units warranted for 12 months from date of startup.

PART 2 - PRODUCTS

DIRECT FIRED MAKE-UP AIR UNITS

Manufacturers: AbsoluteAire, Addison, Greenheck, Reznor, Rapid, Sterling, or Modine.

AGA certified for use with natural gas.

Exterior units cabinet constructed of 16 gauge aluminized steel with enamel finish or 18 gauge galvanized steel, gasketed access panels and doors for access to all components including blower, burner and electrical components.

Insulate cabinet with 1" thick foil faced. Insulation facing erosion resistance as indicated in TIMA standard AHC 101-75, section D-4-10.

Provide centrifugal DWDI forward curved fan with statically and dynamically balanced wheels and one piece through shaft and heavy duty sealed ball bearings with extended grease fittings. Fan shall be isolated from unit with vibration isolators and flexible connectors to prevent vibration from transmitting to the building. As an option to internal vibration isolation provide isolators for [floor mounting][suspending] unit along with pipe flex connectors and duct flex connectors as indicated in section 23 05 48.

Units larger than 20,000CFM shall have a single width, single-inlet backward inclined airfoil plenum type fan with spherical roller bearings and solid steel shaft. Fans shall be statically and dynamically balanced. Provide Variable frequency drive on units for either soft start or space pressure control as specified on schedules.

Motors shall be open drip proof with adjustable belt drives.

Modulating type direct fired burner shall be constructed of cast iron gas manifold connected to stainless steel mixing plates, turndown ratio of 25:1, suitable for heating air from -20 deg. F.

AGA certified gas controls, including flame safeguard relay with flame sensor, high & low gas pressure switches, intermittent spark or hot surface ignition system, manual main shut-off valve, electronic modulating gas valve, pilot controls, electric safety shut-off valve, main and pilot gas regulators suitable for inlet pressure indicated on the drawings.

Provide complete with the following electric controls: Factory installed motor starter with auxiliary contacts, control transformer, high temperature limit switch, low outlet temperature shut-off, high and low flow proving switches, automatic mild weather burner lockout. Contain all electrical in a NEMA 1 control box with fused disconnect,

This Contractor shall provide all temperature control and interlocking necessary to perform the specified control sequence. All relays, transformers and controls are to be in enclosures. Provide factory installed 24 volt control transformer along with a remote control panel including summer/off/winter switch, blower on, burner on, and safety lockout indicator lights and temperature selector with discharge and/or space temperature sensor. All wiring shall be in conduit in accordance with Division 16000 - Electrical and comply with the NEC.

Provide filter section with 2" thick 30% efficient throwaway filters. Provide dirty filter switch with indicating light. Filter section to be low velocity V-bank type.

Provide units complete with the following accessories:
Inlet shut-off damper with motor and end switch.
Filtered Inlet Hood
Roof Curbs

PART 3 - EXECUTION

INSTALLATION

Install units as shown on plans, as detailed and according to the manufacturer's installation instructions.

Pipe vents from gas regulator to outside (where regulators are provided).

Install remote panels and thermostats where indicated on the drawings. Provide all wiring between remote panels/thermostats and the gas fired item.

MAKE UP AIR UNITS

Install on level roof curb as shown on drawings.

END OF SECTION

THIS PAGE INTENTIONALLY LEFT BLANK

SECTION 26 05 00 ELECTRICAL PROVISIONS

PART 1 GENERAL

1.1 SECTION INCLUDES

- A. Work included.
- B. Temporary power and lighting.

1.2 RELATED SECTIONS

- A. Applicable provisions of Division 0 and Division 1 shall govern work under this section.
- B. All 26 00 00 electrical sections.
- C. All other sections requiring electrical work.
- D. Coordinate work under provision of Division One - General Requirements.
- E. Temporary light and power Section of Division 1.
- F. Perform all trenching and backfilling required in connection with the work of this section in strict accordance with the provisions of Division 2 of these Specifications.

1.3 REFERENCES

- A. ANSI/NFPA 70 - National Electrical Code.
- B. NECA "Standard of Installation."
- C. All state and local codes.

1.4 REGULATORY REQUIREMENTS

- A. Conform to requirements of ANSI/NFPA 70.
- B. Furnish products listed and classified by Underwriters Laboratories, Inc as suitable for purpose specified and shown.
- C. Conform to all local codes.

1.5 WORK INCLUDED

- A. The mention of any article, operation or method requires that the Contractor shall provide same and work in complete accordance with the conditions stated. The contractor shall provide all material, labor, equipment, tools and transportation as needed to complete the project according to contract documents. This work includes all items to complete the electrical installation of all items indicated on the drawings, specified herein, and needed for a complete and operable facility but not specifically described in any other sections of this document. Among the items required are:
 - 1. Temporary power and lighting.

2. Branch circuit panels for power and lighting.
 3. Complete branch circuit wiring system for lighting, motors, receptacles, junction boxes and similar uses.
 4. Wall switches, receptacles and similar items.
 5. New electrical service per plans.
 6. Distribution panels as shown on plans.
 7. Complete feeder system, in conduit, to power panels, large individual loads and branch circuit panels.
 8. Lighting fixtures.
 9. Systems:
 - a Phone/Computer: Provide empty conduit and boxes per drawing.
 10. Necessary equipment as shown on plans.
 11. All items and appurtenances necessary, reasonably incidental or customarily included, even though each and every item is not specifically called out for or shown.
 12. Demo work as required. Relocate existing items as required. See drawings and notes.
- B. All work shall be installed in accordance with all state and local inspection authorities having jurisdiction together with the recommendations of the manufacturer whose equipment is to be supplied and installed under this contract.
- C. Before submitting his bid, each bidder shall examine the drawings relating to his work and shall become fully informed as to the extent and character of the work required and its relation to other work in the building.
- D. The contractor shall coordinate with the architect and establish exact locations of all materials and equipment to be installed. Consideration shall be given to construction features, equipment of other trades and requirements of the equipment.
- E. Bids to include cost of all necessary permits and review fees.
- F. This contractor shall keep the engineer, their consultants and the owner of the project harmless from all claims, losses, expenses of any kind, including but not limited to, attorney's expenses and fees, where claims are filed by their own employees or any sub-contractor hired by this contractor and/or their employees. This indemnity shall also apply to any claims filed by others because of work done by this contractor.
- G. This engineer has no contractual duty to control the safest methods or means of the work, job site responsibilities, supervision or to supervise safety and does not voluntarily assume any such duty or responsibility.

1.6 QUALITY ASSURANCE AND WARRANTY

- A. Qualifications of installers: For the actual fabrication, installation and testing of the work of this section, use only thoroughly trained and experienced personnel who are completely familiar with the requirements for this work and with the installation recommendations of the Manufacturers of the specified items.
- B. Perform work to meet all codes.
- C. Contractor shall warranty all parts and labor, except lamps, for one year. All lamps will be working at time of substantial completion. The contractor will replace any lamps not working at time of substantial completion.

1.7 SUBMITTALS

- A. Within 14 days after award of contract, and before any of the materials of this section are delivered to the job site, submit eight complete sets to the Architect in accord with the provisions of Division One - General Requirements, the following:
 - 1. Shop drawings:
 - 1 Distribution equipment
 - 2 Light fixtures including lamp, ballast and driver data
 - 3 Occupancy sensors
 - 4 Wiring devices
 - 5 Any additional data requested
 - 2. Show variations from contract documents.
 - 3. The contractor shall not be relieved of responsibility for executing work in accord with contract documents, even though such drawings have been approved.
- B. Affidavits: The contractor shall execute the standard State Electrical Affidavit of Compliance with the Electrical Code and safe practices. Notarize and file two copies with the owner before final payment is made.
- C. Record Drawings: Day by day, as installed, details shall be transferred to a set of scale tracings prepared by the electrical contractor. The completed tracings shall be turned over to the Owner upon completion.
- D. Operation and Maintenance Data: The contractor shall provide two sets in loose leaf binders a compilation of catalog data of each manufactured item of equipment used in the electrical work and shall present this compilation to the Architect before final payment is made. Descriptive data and printed installation, operating and maintenance instructions and recommended spare parts list for each item of equipment shall be included.

1.8 DELIVERY, STORAGE, AND HANDLING

- A. Deliver, store, protect, and handle Products to site under provisions of Division One - General Requirements.
- B. All materials shall be suitably stored and protected prior to installation and all work, including equipment of other trades, shall be protected after installation, during construction and prior to acceptance.
- C. The contractor shall follow the manufacturer's directions completely in the delivery, storage and handling of equipment and materials. Equipment and materials shall be tightly covered and protected against dirt, water, chemical or mechanical injury and theft. At the completion of the work, fixtures, equipment and materials shall be cleaned and polished thoroughly and shall be in a condition satisfactory to the architect.
- D. Replacements: In the event of damage, immediately make all repairs and replacements necessary to the approval of the Architect and at no additional cost to the Owner.

1.9 PROJECT CONDITIONS

- A. The Electrical Contractor shall visit the site of construction to familiarize himself with the site and existing conditions so as to become fully informed as to extent and character of the work and its relationship to work of other trades and existing facilities.
- B. Failure to provide for the cost of all contingencies in original bid will not be accepted as an excuse for extra payment.

1.10 ALTERNATIVES

- A. The work of this section is affected by alternatives as described on the drawings and in section 01030 of these specifications. All alternates must be approved before bids are submitted.
- B. The Electrical Contractor shall assume full responsibility for any alternate material or item proposed, regardless if it is approved or not. This responsibility will also include any and all costs of modifying feeders, branch circuits, ceilings, finishes, supports, structural, HVAC or any other incidental changes brought about by the alternate.

PART 2 PRODUCTS

2.1 MATERIALS

- A. All equipment and materials shall be new, unless specifically noted otherwise and shall bear the Manufacturer's name, trademark and ASME, UL and/or other labels in every case where a standard has been established for the particular item. Equipment shall be the latest approved design of the standard product of a manufacturer regularly engaged in the production of the required type of equipment and shall be supported by a service organization that is, in the opinion of the architect reasonably convenient to the site.
- B. It is the responsibility of the Contractor to insure that items furnished fit the space available. He shall make field measurements to ascertain space requirements, including those connections, and shall furnish and install such sizes and shapes of equipment that, in the final installation, will suit the true intent and meaning of the Drawings and Specifications.
- C. The Contractor shall furnish and install all equipment accessories, connections and incidental items necessary to complete the work and operations.

PART 3 EXECUTION

3.1 SURFACE CONDITIONS

- A. Inspection: Prior to all work of this section, carefully inspect the installed work of all other trades and verify that all such work is complete to the point where this installation may properly commence.
- B. Verify Conditions: Verify that all electrical installation may be made in complete accord with all pertinent codes, regulations, drawings and specifications.
- C. Discrepancies: In the event of discrepancy, notify the Architect and/or Engineer immediately for clarification. Do not proceed until discrepancies have been fully resolved.

3.2 PREPARATION

- A. Co-ordination of Work: The Contractor shall compare the electrical drawings and specifications with

the drawings and specifications of other trades and report any discrepancies for changes necessary in the electrical work. The electrical work shall be installed in cooperation with other trades installing interrelated work. Before installation, the Contractor shall make proper provisions to avoid interferences. Changes required in the work of the Contractor caused by neglect to do so, shall be made at the Contractor's own expense.

- B. Verification of Dimensions: The contractor shall visit the premises to verify all dimensions in the field; and shall advise the Architect and/or Engineer of any discrepancies before performing any work.

3.3INSTALLATION

- A. It is the intent of this Specification that the Owner is presented with a complete, operable facility and the Electrical Contractor shall include ALL costs in the original bid.
- B. When the Architect has reviewed equipment submittals and given instructions to precede with the installation of items of equipment that require arrangements or connection different from those shown on the drawings, it shall be the responsibility of the contractor to install the equipment to operate properly and in accord with the intent of the drawings and specifications and shall provide any additional controllers, fittings or other equipment and materials that may be required. The contractor shall be responsible for the proper location of roughing in and connections by other trades. All changes shall be made at no increase in the contract amount or additional costs to other trades.
- C. The contractor shall support work and equipment plumb, rigid and true to line. The contractor shall study the general, structural, mechanical and electrical drawings, shop drawings and catalog data to determine how equipment, fixtures, conduit, etc. are to be installed and shall provide foundations, bolts, inserts, stands, hangers, brackets and accessories for proper support whether or not shown on the drawings.
- D. All materials and equipment shall be installed in accord with the approved recommendations of the manufacturer, the best practices of the trade, and in conformance with contract documents. Should the contractor perform any work that does not comply with the manufacturer's directions, the contractor shall bear all costs arising in correcting deficiencies.
- E. Interferences:
 - 1. Locations: Locations of conduit, equipment, fixtures, etc., shall be adjusted to accommodate the work to interferences anticipated or encountered. Devices specifically dimensioned on the drawings are critical dimensions and shall installed as shown. The contractor shall determine the exact route and locations of each conduit prior to installation.
 - 2. Right-of-way: Lines which pitch shall have right-of-way over those which do not pitch. For example, plumbing drains shall normally have right-of-way over lines whose elevations can be changed.
 - 3. Offsets: Offsets and changes in direction in conduit shall be made as required to maintain proper head room and not interfere with pitch of sloping lines whether or not indicated on the drawings.
- F. Location of lighting switches, outlets and equipment as shown on drawings is approximate and exact locations will be verified.
- G. Minor modifications in location of switches, outlets and equipment is considered incidental up to a distance of 10 feet with no additional compensation, provided necessary instructions are given prior

to rough in.

- H. Existing Conditions (if applicable):
 - 1. Move or remove electrical connections, devices or equipment necessary for completion of project and reconnect reused existing equipment or wiring removed to accommodate new work.
 - 2. Existing electrical equipment indicated on the drawings as being removed, reworked or relocated, are shown for guidance and estimating purposes only; additional work found in field or changes required but not shown shall be included in the base bid.
 - 3. Existing equipment that is removed shall remain the property of the owner. That which the owner does not want shall be disposed of by the electrical contractor.
 - 4. Work involving shutdown of present service and equipment now functioning in present area shall be done at such time as to provide the least amount of inconvenience to the owner at times established by the owner.
 - 5. Any existing electrical devices or equipment found at the job site, but not shown on the drawings shall be reconnected to spare circuit breakers in new panels, if such circuits are necessary for operation of the remodeled portion of the building.
 - 6. Locations and elevations of utilities have been obtained from utility maps or other sources and are offered as a general guide only without guarantee as to accuracy. The Contractor shall verify the location and elevation of utilities and their relation to the work before beginning work.

- I. Temporary electric service and lighting during construction:
 - 1. Electrical contractor shall provide temporary light and power.
 - 2. Furnish and install feeders and necessary 12 circuit minimum panels for 120/240V single phase power complete with ground fault protection as required.
 - 3. Each contractor shall provide their own extension cord for portable lamps and tools.
 - 4. Each contractor will make their own service arrangements for heavy duty equipment and tools or other voltages.
 - 5. General contractor to pay for cost of power used. Owner to pay any installation/removal charges for temporary service by utility company.
 - 6. Provide at least one temporary light per small room, hallway or stair. Provide lighting as required in larger areas. Maintain all lamps.
 - 7. Electrical contractor shall be responsible for all aspects of the temporary power and light unless noted otherwise.
 - 8. Remove temporary services and all associated equipment when it is no longer required.

- J. Unless otherwise specified, job finish painting will be done by the painting contractor. Electrical equipment shall have a baked enamel finish. The electrical contractor shall restore damaged painted surfaces of electrical equipment to its original condition.

3.4 FIELD QUALITY CONTROL

- A. Control circuits, branch circuits, feeders, motor circuits and transformers:
 - 1. Megger check of phase-to-phase and phase-to-ground insulation levels. Do not megger check solid state equipment.
 - 2. Continuity.
 - 3. Short circuit.
 - 4. Operational check.

- B. Wiring devices: Test receptacles with Hubbell 5200, Woodhead 1750 or equal tester for correct polarity, proper ground connection and wiring faults.

3.5CLEANING

- A. The electrical contractor shall daily remove crates, boxes, metal cuttings and debris from the building. At the end of the project, all electrically related debris shall be removed and the building shall be left in a clean condition.
- B. The electrical contractor shall leave all electrical equipment (interior and exterior), in a clean condition.

3.6EQUIPMENT START-UP AND TESTING

- A. The contractor shall instruct the owner's operating personnel during start-up and separate operating test of each major item of equipment. During the operating test, the contractor shall prove the operation of each item of equipment to the satisfaction of the architect. At least two days notice shall be given to the architect of equipment start-up and operating tests.
- B. Should any item of the system fail to perform in an approved manner, this test shall be repeated until the operating test is approved by the architect.
- C. Following the successful completion of operating tests by the Contractor, the owner shall have the privilege of making such tests as they may desire to ascertain in detail if any corrections are to be made to the system. At the end of the testing by the owner and architect, the architect shall direct the contractor in writing to make such corrections to the system as are within the scope of the contract.

END OF SECTION

THIS PAGE LEFT INTENTIONALLY BLANK

SECTION 26 05 19 LOW-VOLTAGE ELECTRICAL POWER CONDUCTORS AND CABLES

PART 1 GENERAL

1.1 SECTION INCLUDES

- A. Building wire and cable.
- B. Underground feeder and branch circuit cable.
- C. Wiring connectors and connections.

1.2 RELATED SECTIONS

- A. Section 26 05 33.13 - Conduit.
- B. Section 26 05 33.16 - Boxes.
- C. Section 26 05 53 - Identification.

1.3 REFERENCES

- A. ANSI/NFPA 70 - National Electrical Code.

1.4 SUBMITTALS

- A. Submit under provisions of Division One - General Requirements. Provide upon request.
- B. Product Data: Provide for each cable assembly type.
- C. Test Reports: Indicate procedures and values obtained.
- D. Manufacturer's Installation Instructions: Indicate application conditions and limitations of use stipulated by product testing agency specified under Regulatory Requirements.
- E. Contractor shall review and stamp all shop drawings prior to submitting them for review. Engineer will not review any submittals that have not been stamped by the contractor.

1.5 QUALIFICATIONS

- A. Manufacturer: Company specializing in manufacturing products specified in this Section with minimum three years experience.

1.6 REGULATORY REQUIREMENTS

- A. Conform to requirements of ANSI/NFPA 70 - National Electrical Code.
- B. Furnish products listed and classified by Underwriters Laboratories, Inc. as suitable for purpose specified and shown.
- C. Conform to all local codes.

Bid No. 316014

26 05 19-1
LOW-VOLTAGE ELECTRICAL
POWER CONDUCTORS AND
CABLES

1.7 PROJECT CONDITIONS

- A. Verify that field measurements are as shown on Drawings.
- B. Wire and cable routing shown on Drawings is approximate unless dimensioned. Route wire and cable as required to meet Project Conditions.
- C. Where wire and cable routing is not shown, and destination only is indicated, determine exact routing and lengths required.

1.8 COORDINATION

- A. Coordinate Work under provisions of Division One - General Requirements.
- B. Determine required separation between cable and other work.
- C. Determine cable routing to avoid interference with other work.

PART 2 PRODUCTS

2.1 MANUFACTURERS - BUILDING WIRE

- A. Carol.
- B. Triangle.
- C. Southwire.
- D. Substitutions: Under provisions of Division One - General Requirements.

2.2 BUILDING WIRE

- A. Description: Single conductor insulated wire.
- B. Conductor: Copper.
- C. Insulation Voltage Rating: 600 volts.
- D. Insulation: ANSI/NFPA 70, Type THW, RHW, TW, THHN/THWN, XHHW.
- E. Insulation: Material rated 75 degrees C minimum for branch circuits or feeders in wet and damp locations. Material rated 90 degrees C for feeders in dry locations.

2.3 MANUFACTURERS – BUILDING MC CABLE

- A. Anixter Brothers, Inc.
- B. AFC Cable Systems, Inc.
- C. General Cable Company.

- D. Rome Cable Corp.
- E. Substitutions: Under provisions of Division One - General Requirements.

2.4 BUILDING CABLE: MC

- A. Description: Multi-conductor metal clad cable, polypropylene tape, galvanized steel armor. Lightweight steel metal clad or steel metal clad cable on branch circuits. Steel metal clad fire alarm cable on fire alarm systems.
- B. Conductor: Copper. Where type MC cable carries multiple phase conductors, the cable shall include an oversized neutral conductor (150 to 200%) or one neutral conductor per phase for multi phase systems.
- C. Insulation Voltage Rating: 600 volts.
- D. Insulation: ANSI/NFPA 70, Type THHN, material rated 90 degrees C minimum.
- E. Grounding Conductors: An insulated grounding conductor, sized per code, shall be cabled with the circuit conductors and identified as a ground.
- F. Type MC cable may only be used in concealed areas inside walls, above drop ceilings or at structure or joists in high bay areas.

2.5 WIRING CONNECTORS

- A. Split Bolt Connectors:
 - 1. Burndy.
 - 2. T&B.
 - 3. Blackburn.
 - 4. Panduit.
 - 5. Substitutions: Under provisions of Division One - General Requirements.
- B. Solderless Pressure Connectors:
 - 1. Burndy.
 - 2. T&B.
 - 3. Blackburn.
 - 4. Panduit.
 - 5. Substitutions: Under provisions of Division One - General Requirements.
- C. Spring Wire Connectors:
 - 1. 3M.
 - 2. Ideal.
 - 3. T&B.
 - 4. Blackburn.
 - 5. Panduit.
 - 6. Substitutions: Under provisions of Division One - General Requirements.

- D. Compression Connectors:

Bid No. 316014

26 05 19-3
LOW-VOLTAGE ELECTRICAL
POWER CONDUCTORS AND
CABLES

1. Burndy.
2. T&B.
3. Blackburn.
4. Blackburn.
5. Substitutions: Under provisions of Division One - General Requirements.

PART 3 EXECUTION

3.1 EXAMINATION

- A. Verify that interior of building has been protected from weather.
- B. Verify that mechanical work likely to damage wire and cable has been completed.

3.2 PREPARATION

- A. Completely and thoroughly swab raceway before installing wire.

3.3 WIRING METHODS

- A. Concealed Dry Interior Locations: Use only building wire Type THHN/THWN or type MC cable. MC cable may only be used for branch circuits or fire alarm circuits in concealed locations.
- B. Exposed Dry Interior Locations: Use only building wire Type THHN/THWN, XHHW insulation, in raceway.
- C. Above Accessible Ceilings: Use only building wire Type THHN/THWN, XHHW insulation, in raceway or Type MC cable as allowed by code.
- D. Wet or Damp Interior Locations: Use only building wire Type THHN/THWN, XHHW insulation, in raceway.
- E. Exterior Locations: Use only building wire Type THHN/THWN, XHHW insulation, in raceway.
- F. Underground Installations: Use only building wire Type THW, THHN/THWN, XHHW insulation, in raceway.
- G. Use wiring methods indicated on Drawings.

3.4 INSTALLATION

- A. Install products in accordance with manufacturers instructions.
- B. Use solid or stranded conductors for feeders and branch circuits 10 AWG and smaller.
- C. Use stranded conductors for control circuits.
- D. Use conductor not smaller than 12 AWG for power and lighting circuits. Use oversized neutrals on electronic loads per code.

- E. Use conductor not smaller than 14 AWG for control circuits.
- F. Use 10 AWG conductors for 20 ampere, 120 volt branch circuits longer than 50 feet. Size conductors for 3% voltage drop for circuits longer than 100 feet.
- G. Use 10 AWG conductors for 20 ampere, 277 volt branch circuits longer than 100 feet. Size conductors for 3% voltage drop for circuits longer than 200 feet.
- H. Pull all conductors into raceway at same time.
- I. Use suitable wire pulling lubricant for building wire 4 AWG and larger.
- J. Protect exposed cable from damage.
- K. Support cables above accessible ceiling, using spring metal clips. Do not rest cable on ceiling panels.
- L. Use suitable cable fittings and connectors.
- M. Neatly train and lace wiring inside boxes, equipment, and panelboards.
- N. Clean conductor surfaces before installing lugs and connectors.
- O. Make splices, taps, and terminations to carry full ampacity of conductors with no perceptible temperature rise.
- P. Use suitable reducing connectors or mechanical connector adaptors for connecting aluminum conductors to copper conductors.
- Q. Use split bolt connectors for copper conductor splices and taps, 6 AWG and larger. Tape uninsulated conductors and connector with electrical tape to 150 percent of insulation rating of conductor.
- R. Use solderless pressure connectors with insulating covers for copper conductor splices and taps, 8 AWG and smaller.
- S. Use insulated spring wire connectors with plastic caps for copper conductor splices and taps, 10 AWG and smaller.

3.5 INTERFACE WITH OTHER PRODUCTS

- A. Identify wire and cable under provisions of Section 26 05 53.
- B. Identify each conductor with its circuit number or other designation indicated on Drawings.

3.6 FIELD QUALITY CONTROL

- A. Perform field inspection and testing.
- B. Inspect wire and cable for physical damage and proper connection.

Bid No. 316014

26 05 19-5
 LOW-VOLTAGE ELECTRICAL
 POWER CONDUCTORS AND
 CABLES

C. Measure tightness of bolted connections and compare torque measurements with manufacturer's recommended values.

D. Verify continuity of all conductors.

END OF SECTION

SECTION 26 05 26 GROUNDING AND BONDING FOR ELECTRICAL SYSTEMS

PART 1 GENERAL

1.1 SECTION INCLUDES

- A. Grounding electrodes and conductors.
- B. Equipment grounding conductors.
- C. Bonding.

1.2 REFERENCES

- A. ANSI/NFPA 70 - National Electrical Code.

1.3 GROUNDING ELECTRODE SYSTEM

- A. Metal underground water pipe.
- B. Metal frame of the building.
- C. Concrete-encased electrode.
- D. Rod electrode.

1.4 PERFORMANCE REQUIREMENTS

- A. Grounding System Resistance: 25 ohms.

1.5 PROJECT RECORD DOCUMENTS

- A. Submit upon project completion.
- B. Accurately record actual locations of grounding electrodes .
- C. Record overall resistance to ground.
- D. Contractor shall review and stamp all shop drawings prior to submitting them for review. Engineer will not review any submittals that have not been stamped by the contractor.

1.6 QUALIFICATIONS

- A. Manufacturer: Company specializing in manufacturing Products specified in this Section with minimum 3 years experience.

1.7 REGULATORY REQUIREMENTS

- A. Conform to requirements of ANSI/NFPA 70 - National Electrical Code.
- B. Furnish products listed and classified by Underwriters Laboratories, Inc as suitable for purpose

Bid No. 316014

26 05 26-1
GROUNDING AND BONDING
FOR ELECTRICAL SYSTEMS

- specified and shown.
- C. Conform to all local codes.

PART 2 PRODUCTS

2.1 ROD ELECTRODE

- A. Manufacturers:
 - 1. Appleton.
 - 2. Crouse-Hinds.
 - 3. Burndy.
 - 4. Or approved equal.
- B. Material: Copper-clad steel.
- C. Diameter: 3/4 inch .
- D. Length: 10 feet.

2.2 MECHANICAL CONNECTORS

- A. Manufacturers:
 - 1. Appleton.
 - 2. Crouse-Hinds.
 - 3. Burndy.
 - 4. Or approved equal.
- B. Material: Bronze.

2.3 EXOTHERMIC CONNECTIONS

- A. Manufacturers:
 - 1. Cad-Weld.
 - 2. Or approved equal.

2.4 WIRE

- A. Material: Stranded copper.
- B. Foundation Electrodes: per drawing.
- C. Grounding Electrode Conductor: Size to meet NFPA 70 or local requirements.

PART 3 EXECUTION

3.1 EXAMINATION

- A. Verify that final backfill and compaction has been completed before driving rod electrodes.

3.2 INSTALLATION

- A. Install Products in accordance with manufacturer's instructions.

- B. Install rod electrodes at locations indicated. Install additional rod electrodes as required to achieve specified resistance to ground.
- C. Provide grounding electrode conductor and connect to reinforcing steel in foundation footing where indicated. Bond steel together.
- D. Provide bonding to meet Regulatory Requirements.
- E. Bond together metal siding not attached to grounded structure; bond to ground.
- F. Bond together reinforcing steel and metal accessories in pool and fountain structures.
- G. Provide isolated grounding conductor for circuits supplying electronic equipment.
- H. Equipment Grounding Conductor: Provide separate, insulated conductor within each feeder circuit raceway. Terminate each end on suitable lug, bus, or bushing.
- I. Ground each additional separate neutral to ground rods and water service.
- J. Use 4 AWG minimum copper conductor to ground communications service.
- K. Isolated ground: connect insulated ground conductor from service ground to device.

3.3 FIELD QUALITY CONTROL

- A. Inspect grounding and bonding system conductors and connections for tightness and proper installation.
- B. Use suitable test instrument to measure resistance to ground of system. Perform testing in accordance with test instrument manufacturer's recommendations using the fall-of-potential method.

END OF SECTION

THIS PAGE LEFT INTENTIONALLY BLANK

SECTION 26 05 29 HANGERS AND SUPPORTS FOR ELECTRICAL SYSTEMS

PART 1 GENERAL

1.1 SECTION INCLUDES

- A. Conduit and equipment supports.
- B. Anchors and fasteners.

1.2 REFERENCES

- A. NECA - National Electrical Contractors Association.
- B. ANSI/NFPA 70 - National Electrical Code.

1.3 REGULATORY REQUIREMENTS

- A. Conform to requirements of ANSI/NFPA 70 - National Electrical Code.
- B. Furnish products listed and classified by Underwriters Laboratories, Inc. as suitable for purpose specified and shown.
- C. Conform to all local codes.

PART 2 PRODUCTS

2.1 PRODUCT REQUIREMENTS

- A. Materials and Finishes: Provide adequate corrosion resistance.
- B. Provide materials, sizes, and types of anchors, fasteners and supports to carry the loads of equipment and conduit. Consider weight of wire in conduit when selecting products.
- C. Anchors and Fasteners:
 - 1. Concrete Structural Elements: Use precast insert system, expansion anchors and preset inserts.
 - 2. Steel Structural Elements: Use beam clamps.
 - 3. Concrete Surfaces: Use self-drilling anchors and expansion anchors.
 - 4. Hollow Masonry, Plaster, and Gypsum Board Partitions: Use toggle bolts and hollow wall fasteners.
 - 5. Solid Masonry Walls: Use expansion anchors and preset inserts.
 - 6. Sheet Metal: Use sheet metal screws.
 - 7. Wood Elements: Use wood screws.

2.2 STEEL CHANNEL

- A. Manufacturer:
 - 1. UniStrut
 - 2. B-Line.
 - 3. Allied.

Bid No. 316014

26 05 29-1
HANGERS AND SUPPORTS
FOR ELECTRICAL SYSTEMS

4. Kindorf.
5. Or approved equal.

B. Description: Galvanized (wet, damp locations) or painted steel (dry locations).

PART 3 EXECUTION

3.1 INSTALLATION

- A. Install products in accordance with manufacturer's instructions.
- B. Provide anchors, fasteners, and supports in accordance with NECA "Standard of Installation".
- C. Do not fasten supports to pipes, ducts, mechanical equipment, and conduit.
- D. Do not use spring steel clips and clamps.
- E. Do not use powder-actuated anchors.
- F. Obtain permission from Architect/Engineer before drilling or cutting structural members.
- G. Fabricate supports from structural steel or steel channel. Rigidly weld members or use hexagon head bolts to present neat appearance with adequate strength and rigidity. Use spring lock washers under all nuts.
- H. Install surface-mounted cabinets and panelboards with minimum of four anchors.
- I. In wet and damp locations use steel channel supports to stand cabinets and panelboards one inch off wall.
- J. Use sheet metal channel to bridge studs above and below cabinets and panelboards recessed in hollow partitions.

END OF SECTION

SECTION 26 05 33.13 CONDUIT FOR ELECTRICAL SYSTEMS

PART 1 GENERAL

1.1 SECTION INCLUDES

- A. Metal conduit.
- B. Flexible metal conduit.
- C. Liquidtight flexible metal conduit.
- D. Electrical metallic tubing.
- E. Fittings and conduit bodies.

1.2 RELATED SECTIONS

- A. General Requirements - Division 7 - Roof penetrations and fire stopping.
- B. Section 26 05 33.16 - Boxes.
- C. Section 26 05 26 - Grounding and Bonding.
- D. Section 26 05 29 - Supporting Devices.
- E. Section 26 05 53 - Electrical Identification.

1.3 REFERENCES

- A. ANSI C80.1 - Rigid Steel Conduit, Zinc Coated.
- B. ANSI C80.3 - Electrical Metallic Tubing, Zinc Coated.
- C. ANSI/NEMA FB 1 - Fittings, Cast Metal Boxes, and Conduit Bodies for Conduit and Cable Assemblies.
- D. ANSI/NFPA 70 - National Electrical Code.
- E. NECA "Standard of Installation."
- F. NEMA TC 2 - Electrical Plastic Tubing (EPT) and Conduit (EPC-40 and EPC-80).
- G. NEMA TC 3 - PVC Fittings for Use with Rigid PVC Conduit and Tubing.

1.4 DESIGN REQUIREMENTS

- A. Conduit Size: ANSI/NFPA 70.

1.5 PROJECT RECORD DOCUMENTS

- A. Submit under provisions of 26 05 00.

- B. Accurately record actual routing of conduits larger than 1" inches.

1.6 REGULATORY REQUIREMENTS

- A. Conform to requirements of ANSI/NFPA 70.
- B. Furnish products listed and classified by Underwriters Laboratories, Inc as suitable for purpose specified and shown.
- C. Conform to all local codes.

1.7 DELIVERY, STORAGE, AND HANDLING

- A. Deliver, store, protect, and handle Products to site under provisions of Division One - General Requirements.
- B. Accept conduit on site. Inspect for damage.
- C. Protect conduit from corrosion and entrance of debris by storing above grade. Provide appropriate covering.
- D. Protect PVC conduit from sunlight.

1.8 PROJECT CONDITIONS

- A. Verify that field measurements are as shown on Drawings.
- B. Verify routing and termination locations of conduit prior to rough-in.
- C. Conduit routing is shown on Drawings in approximate locations unless dimensioned. Route as required to complete wiring system.

PART 2 PRODUCTS

2.1 CONDUIT REQUIREMENTS

- A. Minimum Size: 1/2 inch in interior, 3/4 inch exterior.
- B. Underground Installations:
 - 1. Site: Use rigid steel conduit, intermediate metal conduit or nonmetallic PVC conduit. PVC conduit may only be used per local code.
 - 2. In or Under Slab on Grade: Use rigid steel conduit, intermediate metal conduit or thinwall nonmetallic conduit.
 - 3. Minimum Size: 3/4 inch.
 - 4. PVC conduit may be used below grade per code, but not for elbows or stub ups. PVC conduit may be run up inside light pole or generator bases if allowed by local code.
- C. Outdoor Locations, Above Grade: Use rigid steel conduit or intermediate metal conduit.
- D. In Slab Above Grade:
 - 1. Use rigid steel conduit, intermediate metal conduit, or electrical metallic tubing conduit.
 - 2. Maximum Size Conduit in Slab: 1 inch. Maintain a minimum of 2" concrete covering. Run

conduits within concrete parallel to each other and spaced on center at least three times the conduit trade size. Conduits over 1 inch may not be installed in slabs without approval of Architect.

- E. Wet and Damp Locations: Use rigid steel, intermediate metal conduit or PVC (where not subject to damage) per code.
- F. Dry Locations:
 - 1. Concealed: Use electrical metallic tubing.
 - 2. Exposed: Use electrical metallic tubing.

2.2 METAL CONDUIT

- A. Manufacturers:
 - 1. Republic Steel.
 - 2. Allied.
 - 3. Substitutions: Under provisions of Division One - General Requirements.
- B. Rigid Steel Conduit: ANSI C80.1.
- C. Intermediate Metal Conduit (IMC): Rigid steel.
- D. Fittings and Conduit Bodies: ANSI/NEMA FB 1; material to match body.

2.3 FLEXIBLE METAL CONDUIT

- A. Manufacturers:
 - 1. Electri-Flex.
 - 2. Alflec Corp.
 - 3. Substitutions: Under provisions of Division One - General Requirements.
- B. Description: Interlocked steel construction.
- C. Fittings: ANSI/NEMA FB 1.

2.4 LIQUID TIGHT FLEXIBLE METAL CONDUIT

- A. Manufacturers:
 - 1. Electri-Flex.
 - 2. Alflec Corp.
 - 3. Substitutions: Under provisions of Division One - General Requirements.
- B. Description: Interlocked steel construction with PVC jacket.
- C. Fittings: ANSI/NEMA FB 1.

2.5 ELECTRICAL METALLIC TUBING (EMT)

- A. Manufacturers:
 - 1. Republic Steel.
 - 2. Allied.
 - 3. Substitutions: Under provisions of Division One - General Requirements.

- B. Description: ANSI C80.3; galvanized tubing.
- C. Fittings and Conduit Bodies: ANSI/NEMA FB 1; set screw connectors and couplings may be used on interior EMT conduit.

PART 3 EXECUTION

3.1 INSTALLATION

- A. Install conduit in accordance with NECA "Standard of Installation."
- B. Install nonmetallic conduit in accordance with manufacturer's instructions.
- C. Arrange supports to prevent misalignment during wiring installation.
- D. Support conduit using coated steel or malleable iron straps, lay-in adjustable hangers, clevis hangers, and split hangers.
- E. Group related conduits; support using conduit rack. Construct rack using steel channel; provide space on each for 25 percent additional conduits.
- F. Fasten conduit supports to building structure and surfaces under provisions of Section 26 05 29.
- G. Do not support conduit with wire or perforated pipe straps. Remove wire used for temporary supports
- H. Do not attach conduit to ceiling support wires.
- I. Arrange conduit to maintain headroom and present neat appearance.
- J. Route exposed conduit parallel and perpendicular to walls.
- K. Route conduit installed above accessible ceilings parallel and perpendicular to walls.
- L. Route conduit in and under slab from point-to-point.
- M. Do not cross conduits in slab.
- N. Maintain adequate clearance between conduit and piping.
- O. Maintain 12 inch clearance between conduit and surfaces with temperatures exceeding 104 degrees F.
- P. Cut conduit square using saw or pipecutter; de-burr cut ends.
- Q. Bring conduit to shoulder of fittings; fasten securely.
- R. Join nonmetallic conduit using cement as recommended by manufacturer. Wipe nonmetallic conduit dry and clean before joining. Apply full even coat of cement to entire area inserted in fitting. Allow joint to cure for 20 minutes, minimum.
- S. Use conduit hubs or sealing locknuts to fasten conduit to sheet metal boxes in damp and wet locations and to cast boxes.

- T. Install no more than equivalent of three 90-degree bends between boxes. Use conduit bodies to make sharp changes in direction, as around beams. Use hydraulic one-shot bender to fabricate factory elbows for bends in metal conduit larger than 2 inch size.
- U. Avoid moisture traps; provide junction box with drain fitting at low points in conduit system.
- V. Provide suitable fittings to accommodate expansion and deflection where conduit crosses control and expansion joints.
- W. Provide suitable pull string in each empty conduit except sleeves and nipples.
- X. Use suitable caps to protect installed conduit against entrance of dirt and moisture.
- Y. Ground and bond conduit under provisions of Section 26 05 26.
- Z. Identify conduit under provisions of Section 26 05 53.
- AA. All conduit to be concealed, except in mechanical rooms. If accessible walls and ceilings are present in mechanical rooms, conduits and devices will also be concealed. Surface wiring to be used only were absolutely necessary.

3.2INTERFACE WITH OTHER PRODUCTS

- A. Install conduit to preserve fire resistance rating of partitions and other elements, using materials and methods as recommended by manufacturer and under the general provisions. All conduits penetrating non-rated walls shall be caulked.
- B. Route conduit through roof openings for piping and ductwork or through suitable roof jack with pitch pocket. Coordinate location with roofing installer.

END OF SECTION

THIS PAGE LEFT INTENTIONALLY BLANK

SECTION 26 05 33.16 BOXES FOR ELECTRICAL SYSTEMS

PART 1 GENERAL

1.1 SECTION INCLUDES

- A. Wall and ceiling outlet boxes.
- B. Floor boxes.
- C. Pull and junction boxes.

1.2 RELATED SECTIONS

- A. General Requirements - Division 7 - Roof Penetrations and Fire Stopping.
- B. General Requirements - Division 8.
- C. Section 26 27 26 - Wiring Devices: Wall plates in finished areas, floor box service fittings, fire-rated poke-through fittings, and access floor boxes.
- D. Section 28 31 00 - Fire Alarm and Smoke Detection Systems.

1.3 REFERENCES

- A. NECA - Standard of Installation.
- B. NEMA FB 1 - Fittings and Supports for Conduit and Cable Assemblies.
- C. NEMA OS 1 - Sheet-steel Outlet Boxes, Device Boxes, Covers, and Box Supports.
- D. NEMA OS 2 - Nonmetallic Outlet Boxes, Device Boxes, Covers and Box Supports.
- E. NEMA 250 - Enclosures for Electrical Equipment (1000 Volts Maximum).
- F. NFPA 70 - National Electrical Code.

1.4 SUBMITTALS

- A. Submit under provisions of Division One - General Requirements if requested.
- B. Contractor shall review and stamp all shop drawings prior to submitting them for review. Engineer will not review any submittals that have not been stamped by the contractor.

1.5 REGULATORY REQUIREMENTS

- A. Conform to requirements of NFPA 70 - National Electrical Code.
- B. Provide Products listed and classified by Underwriters Laboratories, Inc., as suitable for the purpose specified and indicated.
- C. Conform to all local codes.

PART 2 PRODUCTS

2.1 OUTLET BOXES

- A. Sheet Metal Outlet Boxes: NEMA OS 1, welded, galvanized steel, 4" square minimum. Drawn boxes will not be accepted.
 - 1. Luminaire and Equipment Supporting Boxes: Rated for weight of equipment supported; include 1/2 inch male fixture studs where required.
 - 2. Concrete Ceiling Boxes: Concrete type.
- B. Cast Boxes: NEMA FB 1, Type FD, aluminum. Provide gasketed cover by box manufacturer. Provide threaded hubs.
- C. Wall Plates for Finished Areas: As specified in Section 26 27 26.

2.2 FLOOR BOXES

- A. Floor Boxes: NEMA OS 1, fully adjustable, 1-1/2 inches deep or as shown on drawings.
- B. Material: Cast metal, Formed steel or PVC per drawing.
- C. Shape: Round, or rectangular as shown on drawings.
- D. Service Fittings: As specified in Section 26 27 26.

2.3 PULL AND JUNCTION BOXES

- A. Sheet Metal Boxes: NEMA OS 1, galvanized steel.
- B. Hinged Enclosures: As specified in Section 26 27 26.
- C. Surface Mounted Cast Metal Box: NEMA 250, Type 4; flat-flanged, surface mounted junction box:
 - 1. Material: Galvanized cast iron, Cast aluminum.
 - 2. Cover: Furnish with ground flange, neoprene gasket, and stainless steel cover screws.

PART 3 EXECUTION

3.1 EXAMINATION

- A. Verify locations of floor boxes and outlets in offices, and work areas prior to rough-in.

3.2 INSTALLATION

- A. Install boxes in accordance with NECA "Standard of Installation."
- B. Install in locations as shown on Drawings, and as required for splices, taps, wire pulling, equipment connections and compliance with regulatory requirements.
- C. Set wall mounted boxes at elevations to accommodate mounting heights indicated and specified in section for outlet device.
- D. Electrical boxes are shown on Drawings in approximate locations unless dimensioned. Adjust box location up to 5 feet if required to accommodate intended purpose.

- E. Orient boxes to accommodate wiring devices oriented as specified in Section 26 27 26.
- F. Maintain headroom and present neat mechanical appearance.
- G. Install pull boxes and junction boxes above accessible ceilings and in unfinished areas only.
- H. Inaccessible Ceiling Areas: Install outlet and junction boxes no more than 6 inches from ceiling access panel or from removable recessed luminaire.
- I. Install boxes to preserve fire resistance rating of partitions and other elements, using materials and methods as required.
- J. Coordinate mounting heights and locations of outlets mounted above counters, benches, and backsplashes.
- K. Locate outlet boxes to allow luminaires positioned as shown on reflected ceiling plan.
- L. Align adjacent wall mounted outlet boxes for switches, thermostats, and similar devices.
- M. Use flush mounting outlet box in finished areas.
- N. Locate flush mounting box in masonry wall to require cutting of masonry unit corner only. Coordinate masonry cutting to achieve neat opening.
- O. Do not install flush mounting box back-to-back in walls; provide minimum 6 inches separation. Provide minimum 24 inches separation in acoustic rated walls.
- P. Secure flush mounting box to interior wall and partition studs. Accurately position to allow for surface finish thickness.
- Q. Use stamped steel bridges to fasten flush mounting outlet box between studs.
- R. Install flush mounting box without damaging wall insulation or reducing its effectiveness.
- S. Use adjustable steel channel fasteners for hung ceiling outlet box.
- T. Do not fasten boxes to ceiling support wires.
- U. Support boxes independently of conduit.
- V. Use gang box where more than one device is mounted together. Do not use sectional box.
- W. Use gang box with plaster ring for single device outlets.
- X. Use cast outlet box in exterior locations exposed to the weather and wet locations.
- Y. Use cast floor boxes for installations in slab on grade; formed steel boxes are acceptable for other installations.
- Z. Set floor boxes level.

- AA. Large Pull Boxes: Use hinged enclosure in interior dry locations, surface-mounted cast metal box in other locations.

3.3INTERFACE WITH OTHER PRODUCTS

- A. Coordinate installation of outlet box for equipment connected under Section 26 05 33.16.

3.4ADJUSTING

- A. Adjust floor box flush with finish flooring material.
- B. Adjust flush-mounting outlets to make front flush with finished wall material.
- C. Install knockout closures in unused box openings.

3.5CLEANING

- A. Clean interior of boxes to remove dust, debris, and other material.
- B. Clean exposed surfaces and restore finish.

END OF SECTION

SECTION 26 05 53 IDENTIFICATION FOR ELECTRICAL SYSTEMS

PART 1 GENERAL

1.1 SECTION INCLUDES

- A. Nameplates and labels.
- B. Wire and cable markers.
- C. Conduit markers.

1.2 RELATED SECTIONS

- A. Section 09900 - Painting.

1.3 REFERENCES

- A. ANSI/NFPA 70 - National Electrical Code.

1.4 SUBMITTALS

- A. Submit under provisions of Division One - General Requirements.
- B. Product Data: Provide catalog data for nameplates, labels, and markers.
- C. Manufacturer's Instructions: Indicate application conditions and limitations of use stipulated by Product testing agency specified under regulatory requirements. Include instructions for storage, handling, protection, examination, preparation and installation of Product.

1.5 REGULATORY REQUIREMENTS

- A. Conform to requirements of ANSI/NFPA 70.
- B. Furnish products listed and classified by Underwriters Laboratories, Inc. as suitable for purpose specified and shown.
- C. Conform to all local codes.

PART 2 PRODUCTS

2.1 NAMEPLATES AND LABELS

- A. Nameplates: Engraved three-layer laminated plastic, black letters on white background.
- B. Labels: Embossed adhesive tape, with black letters on white background in shop/mechanical areas or black letters on clear background in office areas.
- C. Locations:
 - 1. Each electrical distribution and control equipment enclosure.
 - 2. Communication cabinets.

Bid No. 316014

26 05 53-1
IDENTIFICATION FOR
ELECTRICAL SYSTEMS

- D. Letter Size:
 - 1. Use 1/8 or 1/4 inch letters for identifying individual equipment and loads.
 - 2. Use 1/4 or 1/2 inch letters for identifying grouped equipment and loads.

2.2 WIRE MARKERS

- A. Manufacturers:
 - 1. Brady self-laminating type.
 - 2. Substitutions: Under provisions of Division One - General Requirements.
- B. Description: self-laminating type wire markers.
- C. Legend:
 - 1. Control Circuits: Control wire number indicated on schematic and interconnection diagrams on drawings and/or shop drawings.

2.3 UNDERGROUND WARNING TAPE

- A. Description: 4 inch wide (minimum) tape, colored yellow with suitable warning legend describing buried electrical lines; HTU6Y-E Model as manufactured by Panduit or equal.

PART 3 EXECUTION

3.1 PREPARATION

- A. Degrease and clean surfaces to receive nameplates and labels.

3.2 APPLICATION

- A. Install nameplate and/or label parallel to equipment lines.
- B. Secure nameplate to equipment front using adhesive.
- C. Secure nameplate to inside surface of door on panelboard that is recessed in finished locations.
- D. Identify underground conduits using underground warning tape. Install one tape per trench at 12 inches above conduit.

END OF SECTION

SECTION 26 05 83 WIRING CONNECTIONS

PART 1 GENERAL

1.1 SECTION INCLUDES

- A. Electrical connections to equipment specified under other sections.

1.2 RELATED SECTIONS

- A. Section 26 05 33.13 - Conduit.
- B. Section 26 05 19 - Building Wire and Cable.
- C. Section 26 05 33.16 - Boxes.

1.3 REFERENCES

- A. NEMA WD 1 - General Purpose Wiring Devices.
- B. NEMA WD 6 - Wiring Device Configurations.
- C. ANSI/NFPA 70 - National Electrical Code.

1.4 REGULATORY REQUIREMENTS

- A. Conform to requirements of ANSI/NFPA 70 - National Electrical Code.
- B. Furnish products listed and classified by Underwriters Laboratories, Inc. as suitable for purpose specified and shown.
- C. Conform to all local codes.

1.5 COORDINATION

- A. Coordinate work under all other sections.
- B. Obtain and review shop drawings, product data, and manufacturer's instructions for equipment furnished under other sections.
- C. Determine connection locations and requirements.
- D. Sequence rough-in of electrical connections to coordinate with installation schedule for equipment.
- E. Sequence electrical connections to coordinate with start-up schedule for equipment.

PART 2 PRODUCTS

- A. All motors provided under other sections.

PART 3 EXECUTION

3.1 EXAMINATION

Bid No. 316014

26 05 83-1
WIRING CONNECTIONS

- A. Verify conditions.
- B. Verify that equipment is ready for electrical connection, wiring, and energization.

3.2 ELECTRICAL CONNECTIONS

- A. Make electrical connections in accordance with equipment manufacturer's instructions.
- B. Make conduit connections to equipment using flexible conduit. Use liquidtight flexible conduit with watertight connectors in damp or wet locations.
- C. Make wiring connections using wire and cable with insulation suitable for temperatures encountered in heat producing equipment.
- D. Provide receptacle outlet where connection with attachment plug is indicated. Provide cord and cap where field-supplied attachment plug is indicated.
- E. Provide suitable strain-relief clamps and fittings for cord connections at outlet boxes and equipment connection boxes.
- F. Install disconnect switches, controllers, control stations, and control devices as indicated.
- G. Modify equipment control wiring with terminal block jumpers as indicated.
- H. Provide interconnecting conduit and wiring between devices and equipment where indicated.
- I. Coolers and Freezers: Cut and seal conduit openings in freezer and cooler walls, floor, and ceilings.

END OF SECTION

SECTION 26 09 16 ELECTRIC CONTROLS AND RELAYS

PART 1 GENERAL

1.1 SECTION INCLUDES

- A. Pushbutton and selector switches.
- B. Control stations.
- C. Relays.

1.2 RELATED SECTIONS

- A. Section 26 27 16 - Enclosures: Cabinets and terminal blocks.

1.3 REFERENCES

- A. NEMA ICS 1 - General Standards for Industrial Control Systems.
- B. NEMA ICS 2 - Standards for Industrial Control Devices, Controllers and Assemblies.
- C. NEMA ICS 6 - Enclosures for Industrial Controls and Systems.
- D. NEMA ST 1 - Standard for Specialty Transformers (Except General Purpose Type.)
- E. NFPA 70 - National Electrical Code.

1.4 SUBMITTALS

- A. Submit under provisions of Division One - General Requirements.
- B. Shop Drawings: Submit to NEMA ICS 1 indicating control panel layouts, wiring connections and diagrams, dimensions, support points.
- C. Product Data: Provide for each component showing electrical characteristics and connection requirements.
- D. Manufacturer's Installation Instructions: Indicate application conditions and limitations of use stipulated by Product testing agency. Include instructions for storage, handling, protection, examination, preparation, installation, and starting of Product.

1.5 REGULATORY REQUIREMENTS

- A. Conform to requirements of NFPA 70.
- B. Furnish Products listed and classified by Underwriters Laboratories, Inc. as suitable for purpose specified and indicated.
- C. Conform to all local requirements.

PART 2 PRODUCTS

Bid No. 316014

26 09 16-1
ELECTRICAL CONTROLS AND RELAYS

2.1 CONTROL SWITCHES AND STATIONS

- A. Manufacturers:
 - 1. Square D 30mm.
 - 2. Siemens 30mm.
 - 3. GE 30mm.
 - 4. Cutler-Hammer 30mm.
- B. Contacts: NEMA ICS 2, Form C.
- C. Contact Ratings: NEMA ICS 2, A150.
- D. Selector Switches Operators: Two, Three position rotary selector switch.
- E. Pushbutton Operator: Unguarded, Recessed, Shrouded, Shielded, Covered or lockable type per drawings.
- F. Control Stations: Heavy duty oiltight type pushbutton station.

2.2 MAGNETIC CONTROL RELAYS

- A. Manufacturers:
 - 1. Square D
 - 2. Siemens
 - 3. GE
 - 4. Cutler-Hammer
- B. Magnetic Control Relays: NEMA ICS 2, Class A300.
- C. Contacts: NEMA ICS 2, Form C, per drawing.
- D. Contact Ratings: NEMA ICS 2, Class A150, per drawing.
- E. Coil Voltage: per drawing

PART 3 EXECUTION

3.1 INSTALLATION

- A. Install in accordance with manufacturer's instructions.
- B. Install individual relays and time delay relays in enclosures.
- C. Install cabinets under the provisions of Section 26 27 16.
- D. Make electrical wiring interconnections as indicated.

END OF SECTION

SECTION 26 09 23 LIGHTING CONTROL DEVICES

PART 1 GENERAL

1.1 SECTION INCLUDES

- A. Occupancy sensors and accessories.

1.2 RELATED SECTIONS

- A. Section 01 91 00 - Commissioning.
- B. Section 26 09 43.13 - Digital Lighting Controls.
- C. Section 26 51 00 - Interior Lighting.
- D. Section 26 56 00 - Exterior Lighting.

1.3 REFERENCES

- A. ANSI C78.379 - Electric Lamps - Incandescent and High- Intensity Discharge Reflector Lamps - Classification of Beam Patterns.
- B. ANSI C82.1 - Ballasts for Fluorescent Lamps - Specifications.
- C. ANSI C82.4 - Ballasts for High-Intensity Discharge and Low Pressure Sodium Lamps (Multiple Supply Type).
- D. ANSI/NFPA 70 - National Electrical Code.
- E. ANSI/NFPA 101 - Life Safety Code.
- F. NEMA WD 6 - Wiring Devices-Dimensional Requirements.

1.4 SUBMITTALS

- A. Submit under provisions of Division One - General Requirements.
- B. Shop Drawings: Indicate dimensions and components for each control device that is not a standard product of the manufacturer.
- C. Product Data: Provide dimensions, ratings, and performance data.
- D. Manufacturer's Instructions: Indicate application conditions and limitations of use stipulated by product testing agency specified under Regulatory Requirements.
- E. Manufacturer's Instructions: Include instructions for storage, handling, protection, examination, preparation, and installation of product.
- F. Contractor shall review and stamp all shop drawings prior to submitting them for review. Engineer will not review any submittals that have not been stamped by the contractor.

1.5 OPERATION AND MAINTENANCE DATA

Bid No. 316014

26 09 23-1
LIGHTING CONTROL DEVICES

- A. Submit under provisions of Division One - General Requirements.
- B. Maintenance Data: Include replacement parts list.

1.6 QUALIFICATIONS

- A. Manufacturer: Company specializing in manufacturing products specified in this Section with minimum ten years experience.

1.7 REGULATORY REQUIREMENTS

- A. Conform to requirements of ANSI/NFPA 70 (National Electrical Code).
- B. Conform to requirements of NFPA 101 .
- C. Furnish products listed and classified by Underwriters Laboratories, Inc. as suitable for purpose specified and shown.
- D. Conform to all local codes.

PART 2 PRODUCTS

2.1 OCCUPANCY SENSORS

- A. Type OS1: Leviton ODS15-1D Wall Switch In Fared Occupancy Sensor
 - 1. Coverage: 180 degree, 2100 sq. ft, 15 foot diameter minor motion, 40 foot diameter major motion.
 - 2. Contact: Incandescent - 800w @ 120V, Fluorescent - 1200VA @120V, 2700VA @277V, motor - 1/4 HP @120V.
 - 3. Or "EQUAL" From Sensor Switch or Wattstopper. "EQUAL" means coverage equal to occupancy sensor specified above. "EQUAL" occupancy sensors must cover the area as required or an additional sensor or sensors must be added.
- B. Type OS2: Leviton OSWV-IOW Wall Mount Infrared Occupancy Sensor
 - 1. Coverage: 115 Degree, 2500 sq ft, 31 foot diameter minor motion, 68 foot diameter major motion.
 - 2. Contact: Incandescent - 800w @ 120V, Fluorescent - 1200VA @120V, 2700VA @277V, motor - 1/4 HP @120V.
 - 3. Include Leviton OSP20-0DO Power Pack: Power Input 120/220/277VAC; 20A Relay- 20A fluorescent/incandescent @120V, 20A fluor. @277V; 1HP @ 120V, 2HP @ 240V.
 - 4. Or "EQUAL" From Sensor Switch or Wattstopper. "EQUAL" means coverage equal to occupancy sensor specified above. "EQUAL" occupancy sensors must cover the area as required or an additional sensor or sensors must be added.
- C. Type OS3: Leviton OSSMD-GD Dual Relay Wall Switch Multi-technology Occupancy Sensor.
 - 1. Coverage: 180 Degree, 2400 sq ft, 20 foot diameter minor motion PIR, 40 foot diameter major motion PIR, 18 foot diameter minor motion U/S, 20 foot diameter major motion U/S.
 - 2. Contact: Incandescent - 800w @ 120V, Fluorescent - 1200VA @120V, 2700VA @277V, motor - 1/4 HP @120V.
 - 3. Or "EQUAL" From Sensor Switch or Wattstopper. "EQUAL" means coverage equal to occupancy sensor specified above. "EQUAL" occupancy sensors must cover the area as required or an additional sensor or sensors must be added.

D. Type OS4: Leviton OSC04-IOW Infrared Ceiling Mount Occupancy Sensor

1. Coverage: 360 degree, 250 sq ft, 5 feet diameter minor motion IR, 12 feet diameter major motion IR.
2. Contact: Incandescent - 800w @ 120V, Fluorescent - 1200VA @120V, 2700VA @277V, motor - 1/4 HP @120V.
3. Include Leviton OSP20-0DO Power Pack: Power Input 120/220/277VAC; 20A Relay- 20A fluorescent/incandescent @120V, 20A fluor. @277V; 1HP @ 120V, 2HP @ 240V.
4. Or "EQUAL" From Sensor Switch or Wattstopper. "EQUAL" means coverage equal to occupancy sensor specified above. "EQUAL" occupancy sensors must cover the area as required or an additional sensor or sensors must be added.

E. Type OS5: Leviton OSC05-M0W Multi-Technology Ceiling Mount Occupancy Sensor.

1. Coverage: 180 degree, 500 sq ft, 17 feet diameter minor motion Ultrasonic, 23 feet diameter major motion Ultrasonic, 20 feet diameter major motion IR.
2. Contact: Incandescent - 800w @ 120V, Fluorescent - 1200VA @120V, 2700VA @277V, motor - 1/4 HP @120V.
3. Include Leviton OSP20-0DO Power Pack: Power Input 120/220/277VAC; 20A Relay- 20A fluorescent/incandescent @120V, 20A fluor. @277V; 1HP @ 120V, 2HP @ 240V.
4. Or "EQUAL" From Sensor Switch or Wattstopper. "EQUAL" means coverage equal to occupancy sensor specified above. "EQUAL" occupancy sensors must cover the area as required or an additional sensor or sensors must be added.

F. Type OS6: Leviton OSC20-M0W Multi-Technology Ceiling Mount Occupancy Sensor.

1. Coverage: 360 degree, 2000 sq ft, 22.5 feet diameter minor motion Ultrasonic, 32 feet diameter major motion Ultrasonic, 20 feet major motion IR.
2. Contact: Incandescent - 800w @ 120V, Fluorescent - 1200VA @120V, 2700VA @277V, motor - 1/4 HP @120V.
3. Include Leviton OSP20-0DO Power Pack: Power Input 120/220/277VAC; 20A Relay- 20A fluorescent/incandescent @120V, 20A fluor. @277V; 1HP @ 120V, 2HP @ 240V.
4. Or "EQUAL" From Sensor Switch or Wattstopper. "EQUAL" means coverage equal to occupancy sensor specified above. "EQUAL" occupancy sensors must cover the area as required or an additional sensor or sensors must be added.

G. Type OS7: Leviton OSC05-U0W Ultrasonic Ceiling Mount Occupancy Sensor.

1. Coverage: 180 degree, 500 sq ft, 17 feet diameter minor motion Ultrasonic, 23 feet diameter major motion Ultrasonic.
2. Contact: Incandescent - 800w @ 120V, Fluorescent - 1200VA @120V, 2700VA @277V, motor - 1/4 HP @120V.
3. Include Leviton OSP20-0DO Power Pack: Power Input 120/220/277VAC; 20A Relay- 20A fluorescent/incandescent @120V, 20A fluor. @277V; 1HP @ 120V, 2HP @ 240V.
4. Or "EQUAL" From Sensor Switch or Wattstopper. "EQUAL" means coverage equal to occupancy sensor specified above. "EQUAL" occupancy sensors must cover the area as required or an additional sensor or sensors must be added.

H. Type OS8: Leviton OSC15-I0W Infrared Ceiling Mount Occupancy Sensor.

1. Coverage: 360 degree, 1500 sq ft, 20 feet diameter major motion IR.
2. Contact: Incandescent - 800w @ 120V, Fluorescent - 1200VA @120V, 2700VA @277V, motor - 1/4 HP @120V.
3. Include Leviton OSP20-0DO Power Pack: Power Input 120/220/277VAC; 20A Relay- 20A fluorescent/incandescent @120V, 20A fluor. @277V; 1HP @ 120V, 2HP @ 240V.
4. Or "EQUAL" From Sensor Switch or Wattstopper. "EQUAL" means coverage equal to occupancy sensor specified above. "EQUAL" occupancy sensors must cover the area as

required or an additional sensor or sensors must be added.

I. Type OS9: Leviton ODS0D-ID Wall Switch Infrared Dual Relay Occupancy Sensor

1. Coverage: 180 degree, 2100 sq. ft, 15 foot diameter minor motion, 40 foot diameter major motion.
2. Primary Contact: Incandescent - 800w @ 120V, Fluorescent - 1200VA @120V, 2700VA @277V, motor - 1/4 HP @120V.
3. Secondary Contact: Incandescent - 800w @ 120V, Fluorescent - 800VA @120V, 2700VA @277V, motor - 1/4 HP @120V.
4. Or "EQUAL" From Sensor Switch or Wattstopper. "EQUAL" means coverage equal to occupancy sensor specified above. "EQUAL" occupancy sensors must cover the area as required or an additional sensor or sensors must be added.

J. Type OS10: Leviton OSW12-M0W Wall Mount Multi-Technology

1. Coverage: 115 Degree, 1200 sq ft, 23 feet diameter minor motion Ultrasonic, 32 feet diameter major motion Ultrasonic, 31 feet diameter minor motion IR, 68 feet diameter major motion IR.
2. Contact: Incandescent - 800w @ 120V, Fluorescent - 1200VA @120V, 2700VA @277V, motor - 1/4 HP @120V.
3. Include Leviton OSP20-0DO Power Pack: Power Input 120/220/277VAC; 20A Relay- 20A fluorescent/incandescent @120V, 20A fluor. @277V; 1HP @ 120V, 2HP @ 240V.
4. Or "EQUAL" From Sensor Switch or Wattstopper. "EQUAL" means coverage equal to occupancy sensor specified above. "EQUAL" occupancy sensors must cover the area as required or an additional sensor or sensors must be added.

K. Type OS11: Leviton OSSMT-GD Wall Switch Multi-Technology Occupancy Sensor

1. Coverage: 180 degree, 1200 sq ft, 20 feet diameter minor motion PIR, 40 feet diameter major motion PIR, 18 feet diameter minor motion U/S, 20 feet diameter major motion U/S.
2. Contact: Incandescent - 800w @ 120V, Fluorescent - 1200VA @120V, 2700VA @277V, motor - 1/4 HP @120V.
3. Or "EQUAL" From Sensor Switch or Wattstopper. "EQUAL" means coverage equal to occupancy sensor specified above. "EQUAL" occupancy sensors must cover the area as required or an additional sensor or sensors must be added.

L. Type OS12: Leviton OSSMD-FT Wall Switch Dual Relay Multi-Technology Occupancy Sensor

1. Coverage: 180 Degree, 2400 sq ft, 20 foot diameter minor motion PIR, 40 foot diameter major motion PIR, 18 foot diameter minor motion U/S, 20 foot diameter major motion U/S.
2. Contact: Incandescent - 800w @ 120V, Fluorescent - 1200VA @120V, 2700VA @277V, motor - 1/4 HP @120V.
3. Or "EQUAL" From Sensor Switch or Wattstopper. "EQUAL" means coverage equal to occupancy sensor specified above. "EQUAL" occupancy sensors must cover the area as required or an additional sensor or sensors must be added.

M. Type OSC13: Leviton OSC20-U0W Ultrasonic Ceiling Mount Occupancy Sensor

1. Coverage: 360 degree, 2000 sq ft, 22.5 feet diameter minor motion Ultrasonic, 32 feet diameter major motion Ultrasonic.
2. Contact: Incandescent - 800w @ 120V, Fluorescent - 1200VA @120V, 2700VA @277V, motor - 1/4 HP @120V.
3. Include Leviton OSP20-0DO Power Pack: Power Input 120/220/277VAC; 20A Relay- 20A fluorescent/incandescent @120V, 20A fluor. @277V; 1HP @ 120V, 2HP @ 240V.
4. Or "EQUAL" From Sensor Switch or Wattstopper. "EQUAL" means coverage equal to occupancy sensor specified above. "EQUAL" occupancy sensors must cover the area as required or an additional sensor or sensors must be added.

N. Type OSC14: EW-205-24-W0R Wall Mount Outdoor Infrared Occupancy Sensor

1. Coverage: 270 degree, 9.5 feet diameter minor motion PIR, 52.5 feet diameter major motion PIR.
2. Contact: Incandescent - 800w @ 120V, Fluorescent - 1200VA @120V, 2700VA @277V, motor - 1/4 HP @120V.
3. Include Leviton OSP20-0DO Power Pack: Power Input 120/220/277VAC; 20A Relay- 20A fluorescent/incandescent @120V, 20A fluor. @277V; 1HP @ 120V, 2HP @ 240V.
4. Or "EQUAL" From Sensor Switch or Wattstopper. "EQUAL" means coverage equal to occupancy sensor specified above. "EQUAL" occupancy sensors must cover the area as required or an additional sensor or sensors must be added.

O. Type OSC15: Lightolier Intellisight ITSCSHB High Bay Ceiling Light

1. Coverage: 260 degree, 2800 sq ft, 25 feet diameter minor motion LED, 40 feet diameter major motion LED.
2. Contact: Incandescent - Fluorescent - 1800VA @120V, 1800VA @277V. Use ITS RP1U (single relay), ITS RP2U (two relay) and/or ITS RP4U (four relay) relay pack as required for application.
3. Or "EQUAL" From Sensor Switch or Wattstopper. "EQUAL" means coverage equal to occupancy sensor specified above. "EQUAL" occupancy sensors must cover the area as required or an additional sensor or sensors must be added.

Q. Type OSC16: Leviton OSC10-M0W Multi-Technology Ceiling Mount

1. Coverage: 360 degree, 1000 sq ft, 17 feet diameter minor motion Ultrasonic, 23 feet diameter major motion Ultrasonic, 20 feet diameter major motion IR.
2. Contact: Incandescent - 800w @ 120V, Fluorescent - 1200VA @120V, 2700VA @277V, motor - 1/4 HP @120V.
3. Include Leviton OSP20-0DO Power Pack: Power Input 120/220/277VAC; 20A Relay- 20A fluorescent/incandescent @120V, 20A fluor. @277V; 1HP @ 120V, 2HP @ 240V.
4. Or "EQUAL" From Sensor Switch or Wattstopper. "EQUAL" means coverage equal to occupancy sensor specified above. "EQUAL" occupancy sensors must cover the area as required or an additional sensor or sensors must be added.

R. Type OSC17: Leviton OSWLR-IOW Long-Range Infrared Wall-Mount

1. Coverage: 360 degree, 100 foot range, 100 feet diameter major motion IR.
2. Contact: Incandescent - 800w @ 120V, Fluorescent - 1200VA @120V, 2700VA @277V, motor - 1/4 HP @120V.
3. Include Leviton OSP20-0DO Power Pack: Power Input 120/220/277VAC; 20A Relay- 20A fluorescent/incandescent @120V, 20A fluor. @277V; 1HP @ 120V, 2HP @ 240V.
4. Or "EQUAL" From Sensor Switch or Wattstopper. "EQUAL" means coverage equal to occupancy sensor specified above. "EQUAL" occupancy sensors must cover the area as required or an additional sensor or sensors must be added.

S. Type OSC18: Leviton OSC10-U0W Ultrasonic Ceiling Mount Occupancy Sensor

1. Coverage: 360 degree, 1000 sq ft, 17 feet diameter minor motion Ultrasonic, 23 feet diameter major motion Ultrasonic.
2. Contact: Incandescent - 800w @ 120V, Fluorescent - 1200VA @120V, 2700VA @277V, motor - 1/4 HP @120V.
3. Include Leviton OSP20-0DO Power Pack: Power Input 120/220/277VAC; 20A Relay- 20A fluorescent/incandescent @120V, 20A fluor. @277V; 1HP @ 120V, 2HP @ 240V.
4. Or "EQUAL" From Sensor Switch or Wattstopper. "EQUAL" means coverage equal to occupancy sensor specified above. "EQUAL" occupancy sensors must cover the area as required or an additional sensor or sensors must be added.

PART 3 EXECUTION

3.1 EXAMINATION

- A. Examine substrate and supporting grids for occupancy control devices.
- B. Examine each occupancy sensor to determine suitability for lamps specified.

3.2 INSTALLATION

- A. Install in accordance with manufacturer's instructions.
- B. Occupancy sensor low voltage wiring may only be exposed along joists in high bay areas or above ceiling grid in office areas. Occupancy sensor low voltage wiring running perpendicular to joists in high bay areas shall be in conduit. In non-high bay areas such as shops, tool rooms, parts rooms and storage areas, low voltage wiring shall be installed inside conduit and boxes.

3.3 FIELD QUALITY CONTROL

- A. Operate each occupancy sensor after installation and connection. Inspect for proper connection and operation.
- B. Complete lighting system performance tests per 01 91 00, Commissioning.

3.4 ADJUSTING

- A. Adjust Work under provisions of Division One -General Requirements.
- B. Aim and adjust occupancy sensors as required.
- C. Install and adjust occupancy sensor shielding as required.

3.5 CLEANING

- A. Clean Work under provisions of Division One - Genral Requirements.
- B. Clean electrical parts to remove conductive and deleterious materials.
- C. Remove dirt and debris from enclosure.
- D. Clean finishes and touch up damage.

3.6 DEMONSTRATION

- A. Provide systems demonstration.

END OF SECTION

SECTION 26 21 16 LOW-VOLTAGE UNDERGROUND ELECTRICAL SERVICE ENTRANCE

PART 1 GENERAL

1.1 SECTION INCLUDES

- A. Service racks.
- B. Metering transformer cabinets.
- C. Meter bases.

1.2 RELATED SECTIONS

- A. Section 26 24 13 - Distribution Switchboards: Metering transformer compartment.

1.3 REFERENCES

- A. NECA Standard of Installation (National Electrical Contractors Association).
- B. NFPA 70 - National Electrical Code.
- C. All local codes.
- D. Utility requirements and specifications.

1.4 SYSTEM DESCRIPTION

- A. System Characteristics:
 - 1. 120/240 Volts, single phase, three wire, 60 Hertz per drawings.
- B. Service Entrance: Underground.

1.5 SUBMITTALS FOR REVIEW

- A. Submit under provisions of Division 1 - General Requirements.
- B. Product Data: Provide ratings and dimensions of transformer cabinets and meter bases.

1.6 SUBMITTALS FOR INFORMATION

- A. Submit Utility Company prepared drawings if required by utility.

1.7 QUALITY ASSURANCE

- A. Utility Company:
 - 1. Adams-Columbia Electric Cooperative
- B. Perform Work in accordance with Utility Company written requirements.
- C. Maintain one copy of Utility requirements on site.

1.8 REGULATORY REQUIREMENTS

- A. Conform to requirements of NFPA 70 - National Electrical Code.
- B. Products: Listed and classified by Underwriters Laboratories, Inc. as suitable for the purpose specified and indicated.
- C. Conform to all local codes.

1.9 PRE-INSTALLATION MEETING

- A. Section 01039 - Coordination and Meetings: Pre-installation meeting.
- B. Coordinate with utility as required. Review service entrance requirements and details with Utility Company representative.

1.10 FIELD MEASUREMENTS

- A. Verify that field measurements are as indicated on Utility Company drawings.

PART 2 PRODUCTS

2.1 METERING

- A. Provide metering as shown on drawings. All metering to meet utility requirements.
- B. Description: Aluminum cabinet with hinged door, conforming to Utility Company requirements, with provisions for locking and sealing on services above 200 Amp. Steel metering cabinet on 200 Amp services.

PART 2.2 EXECUTION

2.3 PREPARATION

- A. Arrange with Utility Company to obtain permanent electric service to the Project.

2.4 INSTALLATION

- A. Install service rack, weatherhead and/or metering as required by Utility Company.

2.5 UTILITY CHARGES

- A. All utility service installation costs charged by utility to be paid by owner.
- B. General contractor to pay for electrical energy used on the temporary and permanent service until the building is complete and turned over to the owner.

END OF SECTION

SECTION 26 24 16 PANELBOARDS

PART 1 GENERAL

1.1 SECTION INCLUDES

- A. Distribution panelboards.
- B. Branch circuit panelboards.
- C. Load centers (only if shown on drawings).

1.2 RELATED SECTIONS

- A. Section 26 05 29 - Supporting Devices.
- B. Section 26 05 53 - Electrical Identification: Engraved nameplates.

1.3 REFERENCES

- A. NECA (National Electrical Contractors Association) "Standard of Installation."
- B. NEMA AB 1 - Molded Case Circuit Breakers.
- C. NEMA ICS 2 - Industrial Control Devices, Controllers, and Assemblies.
- D. NEMA KS 1 - Enclosed Switches.
- E. NEMA PB 1 - Panelboards.
- F. NEMA PB 1.1 - Instructions for Safe Installation, Operation and Maintenance of Panelboards Rated 600 Volts or Less.
- G. NFPA 70 - National Electrical Code.

1.4 SUBMITTALS

- A. Submit under provisions of Division One - General Requirements.
- B. Shop Drawings: Indicate outline and support point dimensions, voltage, main bus ampacity, integrated short circuit ampere rating, circuit breaker and fusible switch arrangement and sizes.
- C. Contractor shall review and stamp all shop drawings prior to submitting them for review. Engineer will not review any submittals that have not been stamped by the contractor.

1.5 PROJECT RECORD DOCUMENTS

- A. Record actual locations of Products; indicate actual branch circuit arrangement.

1.6 OPERATION AND MAINTENANCE DATA

- A. Submit under provisions of Division One - General Requirements.

- B. Maintenance Data: Include spare parts data listing; source of replacement parts and supplies; and recommended maintenance procedures and intervals.

1.7QUALITY ASSURANCE

- A. Perform Work in accordance with NECA Standard of Installation.
- B. Maintain one copy of document on site.

1.8QUALIFICATIONS

- A. Manufacturer: Company specializing in manufacturing the Products specified in this section with minimum ten years experience.

1.9REGULATORY REQUIREMENTS

- A. Conform to requirements of NFPA 70 (National Electrical Code).
- B. Furnish products listed and classified by UL as suitable for purpose specified and indicated.

1.10 FIELD MEASUREMENTS

- A. Verify that field measurements are as indicated on shop drawings and as instructed by manufacturer.

1.11 MAINTENANCE MATERIALS

- A. Provide maintenance materials under provisions of Division One - General Requirements.
- B. Provide two of each panelboard key.

1.12 EXTRA MATERIALS

- A. Furnish under provisions of Division One - General Requirements.
- B. Provide all accessories as needed.

PART 2 PRODUCTS

2.1MANUFACTURERS

- A. General Electric.
- B. Square D.
- C. Cutler-Hammer.
- D. Siemens/ITE.
- E. Above manufacturers to provide equipment equal to that shown on drawings.

2.2DISTRIBUTION PANELBOARDS

- A. Panelboards: NEMA PB 1, circuit breaker type.
- B. Panelboard Bus: Copper, ratings as indicated. Provide copper ground bus in each panelboard.

- C. Minimum integrated short circuit rating: 10,000 amperes rms symmetrical for 240 volt panelboards or as indicated on drawings; 18,000 amperes rms symmetrical for 480 volt panelboards or as indicated on drawings.
- D. Molded Case Circuit Breakers: NEMA AB 1. Provide bolt-on circuit breakers with integral thermal and instantaneous magnetic trip in each pole. Provide circuit breakers UL listed as Type HACR for air conditioning equipment branch circuits.
- E. Molded Case Circuit Breakers with Current Limiters: NEMA AB 1. Provide bolt-on circuit breakers with replaceable current limiting elements, in addition to integral thermal and instantaneous magnetic trip in each pole.
- F. Current Limiting Molded Case Circuit Breakers: NEMA AB 1. Provide bolt on circuit breakers with integral thermal and instantaneous magnetic trip in each pole, coordinated with automatically resetting current limiting elements in each pole. Interrupting rating 100,000 symmetrical amperes, let-through current and energy level less than permitted for same size Class RK-5 fuse.
- G. Provide circuit breaker accessory trip units and auxiliary switches as indicated.
- H. Enclosure: NEMA PB 1, Type 1(indoor/dry) Type 3R (outdoor/wet/damp).
- I. Cabinet Front: Recessed or surface type. Provide hinged door with flush lock. Finish in manufacturer's standard gray enamel.

2.3 BRANCH CIRCUIT PANELBOARDS

- A. Lighting and Appliance Branch Circuit Panelboards: NEMA PB1, circuit breaker type.
- B. Panelboard Bus: Copper, ratings as indicated. Provide copper ground bus in each panelboard.
- C. Minimum integrated short circuit rating: 10,000 amperes rms symmetrical for 240 volt panelboards; 14,000 amperes rms symmetrical for 480 volt panelboards, or as indicated.
- D. Molded Case Circuit Breakers: NEMA AB 1, bolt-on type thermal magnetic trip circuit breakers, with common trip handle for all poles. Provide circuit breakers UL listed as Type SWD for lighting circuits. Provide UL Class A ground fault interrupter circuit breakers where scheduled. Do not use tandem circuit breakers.
- E. Current Limiting Molded Case Circuit Breakers: NEMA AB 1. Provide bolt-on circuit breakers with integral thermal and instantaneous magnetic trip in each pole, coordinated with automatically resetting current limiting elements in each pole. Interrupting rating 100,000 symmetrical amperes, let-through current and energy level less than permitted for same size Class RK-5 fuse.
- F. Enclosure: NEMA PB 1, Type 1 (indoor/dry), Type 3R (outdoor/wet/damp).
- G. Cabinet box: 6 inches deep, 20 inches wide.
- H. Cabinet Front: Flush or Surface cabinet front with concealed trim clamps, concealed hinge, and flush lock all keyed alike. Finish in manufacturer's standard gray

2.4 LOAD CENTERS

- A. Load Centers: Circuit breaker load center, with bus ratings as indicated. Load centers may only be

used if indicated on the drawings.

- B. Minimum integrated short circuit rating: 10,000 amperes rms symmetrical.
- C. Molded Case Circuit Breakers: NEMA AB 1, plug-on type thermal magnetic trip circuit breakers, with common trip handle for all poles. Provide circuit breakers UL listed as Type SWD for lighting circuits switched by circuit breakers. Provide UL Class A ground fault interrupter circuit breakers where indicated. Do not use tandem circuit breakers.
- D. Enclosure: General Purpose or rainproof per drawings.
- E. Box: Flush or Surface type with door, and lock on door. Finish in manufacturer's standard gray enamel.

PART 3 EXECUTION

3.1 INSTALLATION

- A. Install panelboards in accordance with NEMA PB 1.1.
- B. Install panelboards plumb. Install recessed panelboards flush with wall finishes. Provide supports in accordance with Section 26 05 29.
- C. Height: 6 ft to top of panelboard; install panelboards taller than 6 ft with bottom no more than 4 inches (10 cm) above floor.
- D. Provide filler plates for unused spaces in panelboards.
- E. Provide typed circuit directory for each branch circuit panelboard. Revise directory to reflect circuiting changes required to balance phase loads.
- F. Provide engraved plastic nameplates under the provisions of Section 26 05 53.
- G. Provide spare conduits out of each recessed panelboard to an accessible location above ceiling or below floor. Minimum spare conduits: 5 empty 1 inch . Identify each as SPARE.

3.2 FIELD QUALITY CONTROL

- A. Field inspection and testing will be performed under Division One - General Requirements.
- B. Measure steady state load currents at each panelboard feeder; rearrange circuits in the panelboard to balance the phase loads to within 20 percent of each other. Maintain proper phasing for multi-wire branch circuits.
- C. Visual and Mechanical Inspection: Inspect for physical damage, proper alignment, anchorage, and grounding. Check proper installation and tightness of connections for circuit breakers, fusible switches, and fuses.

END OF SECTION

SECTION 26 27 16 ELECTRICAL CABINETS AND ENCLOSURES

PART 1 GENERAL

1.1 SECTION INCLUDES

- A. Hinged cover enclosures.
- B. Terminal blocks.
- C. Accessories.

1.2 RELATED SECTIONS

- A. Section 26 05 29 - Supporting Devices.

1.3 REFERENCES

- A. NEMA 250 - Enclosures for Electrical Equipment (1000 Volts Maximum).
- B. NEMA ICS 4 - Terminal Blocks for Industrial Control Equipment and Systems.
- C. ANSI/NFPA 70 - National Electrical Code.

1.4 REGULATORY REQUIREMENTS

- A. Conform to requirements of ANSI/NFPA 70.
- B. Furnish products listed and classified by Underwriters Laboratories, Inc. as suitable for purpose specified and shown.
- C. Conform to all local codes.

PART 2 PRODUCTS

2.1 MANUFACTURERS

- A. Hoffman.
- B. Saginaw.
- C. Or approved equal.

2.2 HINGED COVER ENCLOSURES

- A. Construction: NEMA 250, Type 1, 3R, 4, 4x steel enclosure as required for application.
- B. Covers: Continuous hinge, held closed by flush latch operable by screwdriver. Outdoor enclosures to have hasp and staple for padlock.
- C. Provide interior metal panel for mounting terminal blocks and electrical components; finish with white enamel.
- D. Enclosure Finish: Manufacturer's standard enamel.

2.3 TERMINAL BLOCKS

- A. Manufacturers:
 - 1. Allen-Bradley.
 - 2. Cutler-Hammer.
 - 3. General Electric.
 - 4. Square D.
- B. Terminal Blocks: ANSI/NEMA ICS 4.
- C. Power Terminals: Unit construction type with closed back and tubular pressure screw connectors, rated 600 volts.
- D. Signal and Control Terminals: Modular construction type, suitable for channel mounting, with tubular pressure screw connectors, rated 300 volts.
- E. Provide ground bus terminal block, with each connector bonded to enclosure. Ground enclosure door.

2.4 ACCESSORIES

- A. Plastic Raceway:
 - 1. Hoffman.
 - 2. Panduit.
 - 3. Tyton.
 - 4. Description: Slotted, light gray with cover.

PART 3 EXECUTION

3.1 EXAMINATION

- A. Coordinate installation with other trades.
- B. Verify that surfaces are ready to receive Work.

3.2 INSTALLATION

- A. Install Products in accordance with manufacturer's instructions.
- B. Install enclosures and boxes plumb. Anchor securely to wall and structural supports at each corner.

END OF SECTION

SECTION 26 27 26 WIRING DEVICES

PART 1 GENERAL

1.1 SECTION INCLUDES

- A. Wall switches.
- B. Wall dimmers.
- C. Receptacles.
- D. Device plates and decorative box covers.

1.2 RELATED SECTIONS

- A. Section 26 05 33.16 - Boxes.

1.3 REFERENCES

- A. NECA - Standard of Installation.
- B. NEMA WD 1 - General Requirements for Wiring Devices.
- C. NEMA WD 6 - Wiring Device -- Dimensional Requirements.
- D. NFPA 70 - National Electrical Code.

1.4 SUBMITTALS FOR REVIEW

- A. Submit under provisions of Division One - General Requirements.
- B. Product Data: Provide manufacturer's catalog information showing dimensions, colors, and configurations.
- C. Contractor shall review and stamp all shop drawings prior to submitting them for review. Engineer will not review any submittals that have not been stamped by the contractor.

1.5 QUALIFICATIONS

- A. Manufacturer: Company specializing in manufacturing the Products specified in this section with minimum three years experience.

1.6 REGULATORY REQUIREMENTS

- A. Conform to requirements of NFPA 70.
- B. Provide Products listed and classified by Underwriters Laboratories, Inc., as suitable for the purpose specified and indicated.
- C. Conform to all local codes.

PART 2 PRODUCTS

Bid No. 316014

26 27 26-1
WIRING DEVICES

2.1 WALL SWITCHES

- A. Single Pole Switch:
 - 1. Leviton: CSB1-20 20 Amp commercial specification grade.
 - 2. Hubbell: 20 Amp commercial specification grade equal to Leviton.
 - 3. Eagle: 20 Amp commercial specification grade equal to Leviton.
- B. Double Pole Switch:
 - 1. Leviton: CSB2-20 20 Amp commercial specification grade.
 - 2. Hubbell: 20 Amp commercial specification grade equal to Leviton.
 - 3. Eagle: 20 Amp commercial specification grade equal to Leviton.
- C. Three-way Switch:
 - 1. Leviton: CSB3-20 20 Amp commercial specification grade.
 - 2. Hubbell: 20 Amp commercial specification grade equal to Leviton.
 - 3. Eagle: 20 Amp commercial specification grade equal to Leviton.
- D. Four-way Switch:
 - 1. Leviton: CSB4-20 20 Amp commercial specification grade.
 - 2. Hubbell: 20 Amp commercial specification grade equal to Leviton.
 - 3. Eagle: 20 Amp commercial specification grade equal to Leviton.
- E. Indicator Switch:
 - 1. Leviton: 1221PL, 1222PL, 1223PL 20 Amp industrial specification grade.
 - 2. Hubbell: 20 Amp industrial specification grade equal to Leviton.
 - 3. Eagle: 20 Amp industrial specification grade equal to Leviton.
- F. Locator Switch:
 - 1. Leviton: 1221LH, 1223LH 20 Amp industrial specification grade.
 - 2. Hubbell: 20 Amp industrial specification grade equal to Leviton.
 - 3. Eagle: 20 Amp industrial specification grade equal to Leviton.
- G. Substitutions: under provisions of Division One - General Requirements.
- H. Color: Per architect and owner.

2.2 INCANDESCENT WALL DIMMERS

- A. Manufacturers:
 - 1. Lithonia: per drawing.
 - 2. Leviton: Equal to specified.
 - 3. Lutron: Equal to specified.
 - 4. Substitutions: under provisions of Division One -General -Requirements.
- B. Description: NEMA WD 1, architectural grade preset slide control dimmer for incandescent lamps.
- C. Power rating as needed for circuit or as indicated on drawing.
- D. Color: Per architect and owner. Switches on emergency power shall be red.

2.3 RECEPTACLES

- A. Single Convenience Receptacle:
 - 1. Leviton: 5088 15 Amp, 5891 20 Amp commercial specification grade.
 - 2. Hubbell: commercial specification grade equal to Leviton.
 - 3. Eagle: commercial specification grade equal to Leviton .
- B. Duplex Convenience Receptacle:
 - 1. Leviton: BR15 15 Amp, BR20 20 Amp commercial specification grade.
 - 2. Hubbell: commercial specification grade equal to Leviton.
 - 3. Eagle: commercial specification grade equal to Leviton.
- C. GFCI Receptacle:
 - 1. Leviton: Interior - 7599 Smart lock pro 15 Amp GFCI, 7899 Smart lock pro 20 Amp GFCI. Interior tamper resistant - T7599 Smart lock pro 15 Amp GFCI, T7899 Smart lock pro 20 Amp GFCI. Exterior weather resistant - W7599 Smart lock pro 15 Amp GFCI, W7899 Smart lock pro 20 Amp GFCI. Exterior weather and tamper resistant - W7599-TR Smart lock pro 15 Amp GFCI, W7899-TR Smart lock pro 20 Amp GFCI.
 - 2. Hubbell: Equal to Leviton.
 - 3. Eagle: Equal to Leviton.
 - 4. Weather resistant in damp or wet locations.
- D. Isolated Ground Receptacle:
 - 1. Leviton: 5262-IG 15 Amp, 5362-IG 20 Amp industrial specification grade.
 - 2. Hubbell: industrial specification grade equal to Leviton.
 - 3. Eagle: industrial specification grade equal to Leviton.
- E. Substitutions: Under provisions of Division One -General Requirements.
- F. Color: Per architect and owner. Receptacles on emergency power shall be red.

2.4 WALL PLATES

- A. Decorative Cover Plate: Thermoplastic (nylon).
 - 1. Leviton: 80700 series.
 - 2. Hubbell: Equal to Leviton.
 - 3. Eagle: Equal to Leviton.
 - 4. Substitutions: under provisions of Division One - General Requirements.
- B. Metal Plate: Surface mount.
 - 1. Appleton: 8300 series or equal.
 - 2. Substitutions: under provisions of Division One - General Requirements.
- C. Weatherproof Cover Plate: Gasketed aluminum with hinged gasketed in-use aluminum device cover.
 - 1. Red Dot: CKMG series wet location in-use receptacle cover or equal.
 - 2. Red Dot: CCT series raintight switch cover or equal.
 - 3. Substitutions: Under provisions of Division One - General Requirements.

PART 3 EXECUTION

3.1 EXAMINATION

Bid No. 313083

26 27 26-3
WIRING DEVICES

- A. Division 1 - Coordination and Meetings: Verification of existing conditions prior to beginning work.
- B. Verify that outlet boxes are installed at proper height.
- C. Verify that wall openings are neatly cut and will be completely covered by wall plates.
- D. Verify that floor boxes are adjusted properly.
- E. Verify that branch circuit wiring installation is completed, tested, and ready for connection to wiring devices.
- F. Verify that openings in access floor are in proper locations.

3.2 PREPARATION

- A. Provide extension rings to bring outlet boxes flush with finished surface.
- B. Clean debris from outlet boxes.

3.3 INSTALLATION

- A. Install in accordance with NECA "Standard of Installation."
- B. Install devices plumb and level.
- C. Install switches with OFF position down.
- D. Install wall dimmers to achieve full rating specified and indicated after derating for ganging as instructed by manufacturer.
- E. Do not share neutral conductor on load side of dimmers.
- F. Install receptacles with grounding pole on bottom.
- G. Connect wiring device grounding terminal to outlet box with bonding jumper or branch circuit equipment grounding conductor.
- H. Install decorative plates on switch, receptacle, and blank outlets in finished areas.
- I. Connect wiring devices by wrapping conductor around screw terminal.
- J. Use jumbo size plates for outlets installed in masonry walls.
- K. Install galvanized steel plates on outlet boxes and junction boxes in unfinished areas, above accessible ceilings, and on surface mounted outlets.
- L. Install protective rings on active flush cover service fittings.

3.4 INTERFACE WITH OTHER PRODUCTS

- A. Coordinate locations of outlet boxes provided under Section 26 05 33.16 to obtain mounting heights [specified and] indicated on drawings.

- B. Install top of wall switch box 48 inches above finished floor.
- C. Install bottom of convenience receptacle box 18 inches above finished floor.
- D. Install bottom of convenience receptacle box 6 inches above counter or backsplash of counter.
- E. Install top of box dimmer 48 inches above finished floor.
- F. Install bottom of telephone jack box 18 inches above finished floor.
- G. Install top of telephone jack box for side-reach wall telephone to position top of telephone at 54 inches above finished floor.
- H. Install top of telephone jack box for forward-reach wall telephone to position top of telephone at 48 inches above finished floor.
- I. Coordinate installation of access floor boxes with access floor system provided under Division One - General Requirements.
- J. Coordinate the installation of wiring devices with underfloor duct service fittings.

3.5 FIELD QUALITY CONTROL

- A. Inspect each wiring device for defects.
- B. Operate each wall switch with circuit energized and verify proper operation.
- C. Verify that each receptacle device is energized.
- D. Test each receptacle device for proper polarity.
- E. Test each GFCI receptacle device for proper operation.
- F. Verify that each telephone jack is properly connected and circuit is operational.

3.6 ADJUSTING

- A. Adjust devices and wall plates to be flush and level.

3.7 CLEANING

- A. Clean exposed surfaces to remove splatters and restore finish.

END OF SECTION

THIS PAGE LEFT INTENTIONALLY BLANK

SECTION 26 28 13 FUSES

PART 1 GENERAL

1.1 SECTION INCLUDES

- A. Fuses for switchboards, distribution equipment, motor control centers, combination starters, transformer protection and disconnect switches.

1.2 RELATED SECTIONS

- A. Section 16441.

1.3 REFERENCES

- A. NFPA 70 - National Electric Code.
- B. NEMA FU 1 - Low Voltage Cartridge Fuses.

1.4 REGULATORY REQUIREMENTS

- A. Conform to requirements of NFPA 70 (National Electrical Code).
- B. Furnish products listed and classified by UL as suitable for purpose specified and indicated.
- C. Conform to all local codes.

PART 2 PRODUCTS

2.1 MANUFACTURERS

- A. Bussmann.
- B. Gould Shawmut.
- C. Littelfuse.

2.2 FUSE REQUIREMENTS

- A. Dimensions and Performance: NEMA FU 1, Class as specified or indicated.
- B. Voltage: Provide fuses with voltage rating suitable for circuit phase-to-phase voltage.
- C. Main Service Switches Larger than 600 amperes: Class L current limiting time delay.
- D. Main Service Switches: Class RK1 time delay.
- E. Motor Load Feeder Switches: Class RK1 time delay.
- F. Lighting Load Feeder Switches: Class RK1 time delay.
- G. Motor Branch Circuits: Class RK1 time delay.

PART 3 EXECUTION

3.1 INSTALLATION

- A. Install fuses in accordance with manufacturer's instructions.
- B. Install fuse with label oriented such that manufacturer, type, and size are easily read.

END OF SECTION

SECTION 26 28 16.16 ENCLOSED SWITCHES

PART 1 GENERAL

1.1 SECTION INCLUDES

- A. Fusible switches.
- B. Nonfusible switches.
- C. Fuses.

1.2 REFERENCES

- A. NEMA KS 1 - Enclosed Switches.
- B. NFPA 70 - National Electrical Code.
- C. UL 198C - High-Interrupting Capacity Fuses; Current Limiting Type.
- D. UL 198E - Class R Fuses.

1.3 SUBMITTALS

- A. Submit under provisions of Division One - General Requirements.
- B. Product Data: Provide switch ratings and enclosure dimensions.
- C. Manufacturer's Instructions: Indicate application conditions and limitations of use stipulated by Product testing agency specified under Regulatory Requirements. Include instructions for storage, handling, protection, examination, preparation, installation, and starting of Product.
- D. Contractor shall review and stamp all shop drawings prior to submitting them for review. Engineer will not review any submittals not stamped by the contractor.

1.4 QUALITY ASSURANCE

- A. Perform Work in accordance with NECA Standard of Installation.
- B. Maintain one copy of each document on site.

1.5 QUALIFICATIONS

- A. Manufacturer: Company specializing in manufacturing Products specified in this Section with minimum ten years experience.

1.6 REGULATORY REQUIREMENTS

- A. Conform to requirements of NFPA 70.
- B. Furnish products listed and classified by UL as suitable for purpose specified and shown.
- C. Conform to all local codes.

1.7EXTRA MATERIALS

- A. Furnish under provisions of Division One - General Requirements.
- B. Provide three of each size and type fuse installed.

PART 2 PRODUCTS

2.1MANUFACTURERS

- A. General Electric.
- B. Square D.
- C. Cutler-Hammer.
- D. Siemens/ITE.
- E. Above manufacturers to provide equipment equal to that shown on drawings.

2.2ENCLOSED SWITCHES

- A. Fusible Switch Assemblies: NEMA KS 1, Type HD load interrupter enclosed knife switch with externally operable handle interlocked to prevent opening front cover with switch in ON position. Handle lockable in OFF position. Fuse clips: Designed to accommodate Class R fuses.
- B. Nonfusible Switch Assemblies: NEMA KS 1, Type HD load interrupter enclosed knife switch with externally operable handle interlocked to prevent opening front cover with switch in ON position. Handle lockable in OFF position.
- C. Enclosures: NEMA KS 1.
 - 1. Interior Dry Locations: Type 1.
 - 2. Exterior Locations: Type 3R.
 - 3. Wash down Locations: Type 4,4X.

2.3FUSES

- A. Manufacturers:
 - 1. Bussmann
 - 2. Gould Shawmut.
 - 3. Littelfuse.
- B. Description: Dual element, current limiting, time delay, one-time fuse, 250, 600 volt, UL 198E, Class RK 1.
- C. Interrupting Rating: 200,000 rms amperes.

PART 3 EXECUTION

3.1INSTALLATION

- A. Install disconnect switches where indicated.
- B. Install fuses in fusible disconnect switches.
- C. Provide adhesive label on inside door of each switch indicating UL fuse class and size for

replacement.

END OF SECTION

THIS PAGE LEFT INTENTIONALLY BLANK

SECTION 26 51 00 INTERIOR LIGHTING

PART 1 GENERAL

1.1 SECTION INCLUDES

- A. Interior luminaires and accessories.
- B. Emergency lighting units.
- C. Exit signs.
- D. Ballasts.
- E. Fluorescent dimming ballasts and controls.
- F. Fluorescent lamp emergency power supply.
- G. Lamps.
- H. Luminaire accessories.

1.2 RELATED SECTIONS

- A. Section 01 91 00 - Commissioning
- B. Section 26 05 33.16 - Boxes.
- C. Section 26 09 23 - Lighting Control Devices.
- D. Section 26 09 43 - Digital Lighting Controls.

1.3 REFERENCES

- H. ANSI C78.379 - Electric Lamps - Incandescent and High- Intensity Discharge Reflector Lamps - Classification of Beam Patterns.
- I. ANSI C82.1 - Ballasts for Fluorescent Lamps - Specifications.
- J. ANSI C82.4 - Ballasts for High-Intensity Discharge and Low Pressure Sodium Lamps (Multiple Supply Type).
- K. ANSI/NFPA 70 - National Electrical Code.
- L. ANSI/NFPA 101 - Life Safety Code.
- M. NEMA WD 6 - Wiring Devices-Dimensional Requirements.

1.4 SUBMITTALS

- A. Submit under provisions of Division One - General Requirements.

Bid No. 316014

26 51 00-1
INTERIOR LIGHTING

- B. Shop Drawings: Indicate dimensions and components for each luminaire that is not a standard product of the manufacturer.
- C. Product Data: Provide dimensions, ratings, and performance data.
- D. Manufacturer's Instructions: Indicate application conditions and limitations of use stipulated by product testing agency specified under Regulatory Requirements.
- E. Manufacturer's Instructions: Include instructions for storage, handling, protection, examination, preparation, and installation of product.
- F. Contractor shall review and stamp all shop drawings prior to submitting them for review. Engineer will not review any submittals that have not been stamped by the contractor.

1.5 OPERATION AND MAINTENANCE DATA

- A. Submit under provisions of Division One - General Requirements.
- B. Maintenance Data: Include replacement parts list.

1.6 QUALIFICATIONS

- A. Manufacturer: Company specializing in manufacturing products specified in this Section with minimum ten years experience.

1.7 REGULATORY REQUIREMENTS

- A. Conform to requirements of ANSI/NFPA 70 (National Electrical Code).
- B. Conform to requirements of NFPA 101 .
- C. Furnish products listed and classified by Underwriters Laboratories, Inc. as suitable for purpose specified and shown.
- D. Conform to all local codes.

PART 2 PRODUCTS

2.1 LUMINAIRES

- A. Furnish products as specified in schedule on Drawings.
- B. Install ballasts, lamps, and specified accessories at factory.

2.2 EMERGENCY LIGHTING UNITS

- A. Furnish products as specified in schedule on Drawings.

2.3 EXIT SIGNS

- A. Furnish products as specified in schedules on drawings.

2.4 BALLASTS

26 51 00-2
INTERIOR LIGHTING

Bid No. 316014

- A. Fluorescent Ballast:
 - 1. Advance.
 - 2. Universal.
 - 3. Vermont.
 - 4. Motorola.
 - 5. Substitutions: Under provisions of Division One - General Requirements.
 - 6. Source Quality Control: Certify ballast design and construction by Certified Ballast Manufacturers, Inc.

- B. High Intensity Discharge (HID) Ballast:
 - 1. Advance.
 - 2. Universal.
 - 3. Vermont.
 - 4. Substitutions: Under provisions of Division One - General Requirements.

2.5 LAMPS

- A. Incandescent Lamp Manufacturers:
 - 1. General Electric.
 - 2. Phillips..
 - 3. Sylvania.
 - 4. Substitutions: Under provisions of Division One- General Requirements.

- B. Fluorescent Lamp Manufacturers:
 - 1. General Electric.
 - 2. Phillips.
 - 3. Sylvania.
 - 4. Substitutions: Under provisions of Division One - General Requirements.

2.6 LED LUMINAIRES

- A. LED luminaires shall be equal to the specified LED luminaire by the following criteria:
 - 1. Fixture must be of similar construction and aesthetics.
 - 5. Delivered lumen range: -2% to +8% of lumens listed on light fixture schedule.
 - 6. Luminaire Efficacy: up to -5%
 - 7. Energy consumption: maximum wattage listed on light fixture schedule.
 - 5. Color temperature: +/- 200K of color temperature listed in light fixture schedule.
 - 6. Color rendering index: minimum 80 CRI interior, minimum 70 CRI exterior.
 - 7. Energy consumption: maximum wattage listed on light fixture schedule.
 - 8. Beam Spread: +/- 4%
 - 9. Spacing ratio: +/- 0.1
 - 10. Physical size: must be the same size or smaller.

PART 3 EXECUTION

3.1 EXAMINATION

- A. Examine substrate and supporting grids for luminaires.

- B. Examine each luminaire to determine suitability for lamps specified.

3.2 INSTALLATION

Bid No. 316014

26 51 00-3
INTERIOR LIGHTING

- A. Install in accordance with manufacturers instructions.
- B. Install suspended luminaires and exit signs using pendants supported from swivel hangers. Provide pendant length required to suspend luminaire at indicated height.
- C. Support luminaires larger than 2 x 4 foot size independent of ceiling framing.
- D. Locate recessed ceiling luminaires as indicated on reflected ceiling plan.
- E. Install surface mounted luminaires and exit signs plumb and adjust to align with building lines and with each other. Secure to prohibit movement.
- F. Install recessed luminaires to permit removal from below.
- G. Install recessed luminaires using accessories and firestopping materials to meet regulatory requirements for fire rating.
- H. Install clips to secure recessed grid-supported luminaires in place.
- I. Install wall mounted luminaires , emergency lighting units and exit signs at height as indicated on Drawings.
- J. Install accessories furnished with each luminaire.
- K. Connect luminaires , emergency lighting units and exit signs to branch circuit outlets provided under Section 26 05 33.16 using flexible conduit as indicated.
- L. Make wiring connections to branch circuit using building wire with insulation suitable for temperature conditions within luminaire.
- M. Bond products and metal accessories to branch circuit equipment grounding conductor.
- N. Install specified lamps in each luminaire , emergency lighting unit and exit sign.
- O. Occupancy sensor low voltage wiring may only be exposed along joists in high bay areas or above ceiling grid in office areas. Occupancy sensor low voltage wiring running perpendicular to joists in high bay areas shall be in conduit. In non-high bay areas such as shops, tool rooms, parts rooms and storage areas, low voltage wiring shall be installed inside conduit and boxes.

3.3FIELD QUALITY CONTROL

- A. Operate each luminaire after installation and connection. Inspect for proper connection and operation.
- B. Factory trained lighting control technician shall complete lighting control panel system performance tests per 01 91 00, Commissioning and 26 09 43.13, Digital Lighting Controls.

3.4ADJUSTING

- A. Adjust Work under provisions of Division One -General Requirements.
- B. Aim and adjust luminaires as required.

- C. Adjust exit sign directional arrows as indicated.
- D. Relamp luminaires that have failed lamps at Substantial Completion.

3.5CLEANING

- A. Clean Work under provisions of Division One - General Requirements.
- B. Clean electrical parts to remove conductive and deleterious materials.
- C. Remove dirt and debris from enclosure.
- D. Clean photometric control surfaces as recommended by manufacturer.
- E. Clean finishes and touch up damage.

3.6DEMONSTRATION

- A. Provide systems demonstration.

END OF SECTION

THIS PAGE LEFT INTENTIONALLY BLANK

SECTION 26 56 00 EXTERIOR LIGHTING

PART 1 GENERAL

1.1 SECTION INCLUDES

- A. Exterior luminaires and accessories.
- B. Poles.

1.2 RELATED SECTIONS

- A. Section 03300 - Cast-in-Place Concrete: Foundations for poles.

1.3 REFERENCES

- A. ANSI C78.379 - Electric Lamps - Incandescent and High- Intensity Discharge Reflector Lamps - Classification of Beam Patterns.
- B. ANSI C82.1 - Ballasts for Fluorescent Lamps- Specifications.
- C. ANSI C82.4 - Ballasts for High-Intensity-Discharge and Low-Pressure Sodium Lamps (Multiple-Supply Type).
- D. ANSI O5.1 - Specifications and Dimensions for Wood Poles.
- E. ANSI/NFPA 70 - National Electrical Code.
- F. ANSI/IES RP-8 - Recommended Practice for Roadway Lighting.
- G. ANSI/IES RP-20 - Lighting for Parking Facilities.

1.4 SYSTEM DESCRIPTION

- A. Parking lot, roadway lighting per drawings.
- B. Exterior building lighting per drawings.

1.5 SUBMITTALS

- A. Submit under provisions of Division One - General Requirements.
- B. Shop Drawings: Indicate dimensions and components for each luminaire which is not a standard product of the manufacturer.
- C. Product Data: Provide dimensions, ratings, and performance data.
- D. Manufacturer's Instructions: Include instructions for storage, handling, protection, examination, preparation, installation, and starting of product.

1.6 PROJECT RECORD DOCUMENTS

- A. Submit under provisions of Division One - General Requirements.

Bid No. 316014

26 56 00-1
EXTERIOR LIGHTING

- B. Accurately record actual locations of each luminaire and conduit.

1.7 OPERATION AND MAINTENANCE DATA

- A. Submit under provisions of Division One - General Requirements.
- B. Maintenance Data: Include instructions for maintaining luminaires.

1.8 QUALIFICATIONS

- A. Manufacturer: Company specializing in manufacturing products specified in this Section with minimum three years experience.

1.9 REGULATORY REQUIREMENTS

- A. Conform to requirements of ANSI/NFPA 70.
- B. Furnish products listed and classified by Underwriters Laboratories, Inc. as suitable for purpose specified and shown.
- C. Conform to all local codes.

1.10 DELIVERY, STORAGE, AND HANDLING

- A. Deliver, store, protect, and handle products to site under provisions of Division One - General Requirements.
- B. Accept products on site. Inspect for damage.
- C. Protect poles from finish damage by handling carefully.
- D. Store and handle solid wood poles in accordance with ANSI O5.1.

1.11 COORDINATION

- A. Furnish bolt templates and pole mounting accessories to installer of pole foundations.

PART 2 PRODUCTS

2.1 LUMINAIRES

- A. Furnish products as specified in schedule on Drawings.
- B. Substitutions: No substitutes accepted after bids are turned in.
- C. Mounting: As specified on drawings.
- D. Accessories:
 - 1. Provide control per drawings.

2.2 BALLASTS/DRIVERS

- A. Fluorescent Ballast:
 - 1. Advance.
 - 2. GE.
 - 3. Or equal.
 - 4. Description: ANSI C82.1, high power factor type electromagnetic ballast.
 - 5. Provide ballast suitable for lamps specified.
 - 6. Voltage: Match luminaire voltage.
 - 7. Source Quality Control: Certify ballast design and construction by Certified Ballast Manufacturers, Inc.

- B. High Intensity Discharge (HID) Ballast:
 - 1. Advance.
 - 2. GE.
 - 3. Or equal.
 - 4. Description: ANSI C82.3.4, mercury vapor, metal halide, low pressure sodium, high pressure sodium lamp ballast.
 - 5. Provide ballast suitable for lamp specified.
 - 6. Voltage: Match luminaire voltage.

- C. LED drivers as specified.

2.3 LAMPS

- A. Incandescent Lamp Manufacturers:
 - 1. Phillips
 - 2. GE.
 - 3. Sylvania.
 - 4. Or approved equal.

- B. Fluorescent Lamp Manufacturers:
 - 1. Phillips.
 - 2. GE.
 - 3. Sylvania.
 - 4. Or approved equal.

- C. High Intensity Discharge (HID) Lamp Manufacturers:
 - 1. Phillips.
 - 2. GE.
 - 3. Sylvania.
 - 4. Or approved equal.

- D. Reflector Lamp Beam Patterns: ANSI C78.379.

2.4 LED LUMINAIRES

- A. LED luminaires shall be equal to the specified LED luminaire by the following criteria:
 - 1. Fixture must be of similar construction and aesthetics.
 - 5. Delivered lumen range: -2% to +8% of lumens listed on light fixture schedule.
 - 6. Luminaire Efficacy: up to -5%
 - 7. Energy consumption: maximum wattage listed on light fixture schedule.
 - 5. Color temperature: +/- 200K of color temperature listed in light fixture schedule.
 - 6. Color rendering index: minimum 80 CRI interior, minimum 70 CRI exterior.
 - 7. Energy consumption: maximum wattage listed on light fixture schedule.

8. Beam Spread: +/- 4%
9. Spacing ratio: +/- 0.1
10. Physical size: must be the same size or smaller.
11. Exterior IES distribution pattern: match specification or provide point by point calculations matching specified intent.
12. BUG: match or exceed specified BUG rating.

2.5 POLES

- A. Manufacturers:
 1. Per schedule on drawings.
- B. Material and Finish: per drawing.
- C. Accessories:
 1. Handhole.
- D. Loading Capacity Ratings:
 1. Verify pole loading capacity is not exceeded.

PART 3 EXECUTION

3.1 EXAMINATION

- A. Examine excavation and concrete foundation for lighting poles.
- B. Examine each luminaire to determine suitability for lamps specified.

3.2 INSTALLATION

- A. Install in accordance with manufacturers' instructions.
- B. Install lighting poles at locations indicated.
- C. Install poles plumb. Provide double nuts to adjust plumb. Grout around each base.
- D. Install lamps in each luminaire.
- E. Bond luminaires, metal accessories and metal poles to branch circuit equipment grounding conductor. Provide supplementary grounding electrode at each pole.

3.3 FIELD QUALITY CONTROL

- A. Operate each luminaire after installation and connection. Inspect for improper connections and operation.

3.4 ADJUSTING

- A. Adjust work under provisions of Division One - General Requirements.
- B. Aim and adjust luminaires to provide illumination levels and distribution indicated on Drawings or as directed.

- C. Relamp luminaires which have failed lamps at Date of Substantial Completion.

3.5CLEANING

- A. Clean work under provisions of Division One - General Requirements.
- B. Clean electrical parts to remove conductive and deleterious materials.
- C. Remove dirt and debris from enclosure.
- D. Clean photometric control surfaces as recommended by manufacturer.
- E. Clean finishes and touch up damage.

END OF SECTION

THIS PAGE LEFT INTENTIONALLY BLANK

SECTION 31 20 00 EARTHWORK

SCOPE Applicable provisions of the General and Supplementary Conditions and Division 1 govern work under this Section.

INDEX	1.1 Description	3.5 Excavation Bracing & Sloping
	1.2 Quality Assurance	3.6 Unanticipated Subsurface Conditions
	1.3 Submittals	3.7 Excess Water Control
	1.4 Job Conditions	3.8 Preparation of Subgrade
	2.1 Fill Material	3.9 Back Filling
	2.2 Other Materials	3.10 Compaction
	3.1 Surface Conditions	3.11 Site Access for Other Contractors
	3.2 Preparation	3.12 Surplus Earth Material
	3.3 Excavation	3.13 Grading
	3.4 Trenching	3.14 Clean-Up and Damage

PART 1 GENERAL

1.1 Description

- A. Work Included: Excavating, filling and grading required for this Work includes, but is not necessarily limited to:
1. Excavating for footings and foundations.
 2. Building excavation.
 3. Filling and backfilling to attain indicated grades.
 4. Trenching and trench backfilling.
 5. Rough and finish grading of the site.
 6. Furnishing and installing granular cushion under all concrete slabs on grade.
 7. Soil compaction.
 8. Drainage of site for work in progress.
 9. Erosion control.
 10. Removal of excess topsoil and sub base earth materials off site.
- B. Related Work Specified Elsewhere
- | | |
|----------------------------|------------------|
| 1. Instructions to Bidders | Section 00 21 13 |
| 2. Concrete | Section 03 30 00 |
| 3. Landscaping | Section 32 90 00 |

1.2 Quality Assurance

- A. Testing Agency
1. In-place soil compaction tests to be performed by testing laboratory employed by Owner.
 2. Test on material for controlled fill to be performed by testing laboratory employed by Contractor.
- B. Allowable Tolerances
1. Grading tolerances:
 - a. Rough grade: Building and parking areas – plus or minus 0.1 foot.
 - b. Finish grade
 - (1) Granular cushion under concrete slabs – plus or minus 0.1 foot.

- (2) Parking areas: See Section 32 12 00.
- (3) Landscaped areas: See Section 32 90 00 or Landscape Plan.

C. Reference Standards

- 1. American Society for Testing and Materials (ASTM):
 - a. D 698 Moisture-Density Relations of Soils Using 5 pound Rammer and 12-inch Drop, Standard Proctor Method.
 - b. D 2922 Nuclear Density Testing of Soil in Place, Shallow Depth.

1.3 Submittals: Within 35 days after award of Contract, and before any of the materials of this Section are delivered to the job site, submit complete to the Architect in accordance with these Specification; the following.

A. Samples of Granular Backfill

- 1. Submit sample for under slab fill. See Soils report for approved design recommendations.
- 2. A seventy-five (75) pound bag of any imported granular fill.

B. State of WI and local ordinance specification for soil erosion control.

C. Test Reports.

1.4 Job Conditions

A. Environmental Requirements

- 1. The site preparation Contractor will provide for erosion control over entire site in a manner that will satisfy all applicable regulations for same by the McFarland, County of Dane Co., the State of WI, and the Federal Government. The cost for the requirement will be included in the contractor's proposal. This system will remain in effective operation until project is complete.
- 2. A written plan listing methods, materials, and means to satisfy all of the above will be submitted to the Owner within 14 days of receiving a Letter of Intent to enter into a contract from the Owner.
- 3. Provide dewatering and drainage as required to accomplish Work of this Section.
- 4. Dust Control: provide as necessary to meet requirements and local ordinances.
 - a. Use all means necessary to control dust on and near the Work and on and near all off-site borrow areas if such dust is caused by the Contractor's operations during performance of the Work or if resulting from the conditions in which the Contractor leaves the site.
 - b. Thoroughly moisten all surfaces as required to prevent dust being a nuisance to the public, neighbors and concurrent performance of other work on the Site.

B. Protection

- 1. Use all means necessary to protect all materials of this Section before, during and after installation and to protect all objects designated to remain.
- 2. Provide site erosion control per jurisdictional requirements as noted above.
- 3. Erect sheeting, shoring and bracing as necessary for protection of persons, improvements and excavations.
- 4. In the event of damage, immediately make all repairs and replacements necessary to the approval of the Architect and at no additional cost to the Owner.

PART 2 PRODUCTS

2.1 Fill Material

A. General

1. Approval required: All fill material shall be subject to the acceptance of the Soils Engineer.
2. Notification: For approval of fill material, notify the Soils Engineer at least four days in advance when using excavated materials.

B. Fill Material:

1. General: All fill material shall be of a nature with sufficient binder to form a firm and stable unyielding subgrade.
2. Crushed stone and sand may be substituted with the acceptance by Soils Engineer.
3. Expansion: All fill earth shall have a coefficient of expansion of not more than 3 percent from air dry to saturation under a surcharge of 60 pounds per square foot at 98 percent compaction.
4. Cleanliness: All fill earth shall be clean and free from debris and from rock larger than three inches in maximum dimension.
5. The cushion under exterior slabs, drains and walks shall be clean granular soil material with no more than 5% passing the No. 200 sieve and at least 90% passing the 1" sieve. Soils meeting Unified Soil Classification (USCC) categories SP, GP or GW may qualify.

C. Interior Fill Material: Fill under all interior concrete slabs on grade shall be clean well graded crushed limestone with particle size grading within the follow limits.

1. Passing the one inch mesh: 100 percent.
2. Passing the number four sieve: 25-60 percent.
3. Passing the number 200 sieve: 3-12 percent.
4. Depth: as shown on Drawings.

D. Trench and Structural Backfill

1. On-Site fill material: All on-site material used for trench and structural backfill shall meet the requirements of Article 2.1.B above.
2. Imported Material: All imported material used for trench and structural backfill shall meet the requirements of Article 2.1.B above.
3. Maximum Lift Thickness: Nine (9) inches.

E. Exterior Foundation Wall Backfill: Compacted on-site clay soil as approved by the Soils Engineer or as specified in 2.1 B. above.

F. Fill Beneath Foundations: All fill material has been placed and approved by the Soils Engineer.

G. Contractor can use on-site compactable materials to bring soil up to subgrade elevations below limestone fill under slabs; and for use in backfill. On-site materials may be used if tested by the Soils Engineer and verified to contain the proper composition and is dry enough for proper compaction.

- 2.2 Other Materials:** All other materials, not specifically described but shown on drawings or as required for proper completion of the work of this Section, shall be as selected by the Contractor subject to the approval of the Architect.

PART 3 EXECUTION

3.1 Surface Conditions

- A. Inspection
1. Verify that preceding work affecting work of this Section has been satisfactory completed.
 2. Prior to all work of this Section, become thoroughly familiar with the site, site conditions and all portions of the Work falling within this Section.

3.2 Preparation

- A. Field Measurements
1. Finish Elevations and Lines: For the setting and establishing finish elevations and lines, establish two independent bench marks, carefully preserve all data and all bench marks. If displaced or lost, immediately replace to the approval of the Architect and at no additional cost to the Owner. Remove at completion of project.
 2. **This contractor will be required to submit in writing that the existing grades have been verified and are within acceptable tolerances. If such verification is NOT received by the Architect prior to the start of excavation, contractor accepts ALL responsibility.**
- B. Brush and tree removal: as indicated on the site plan. Remove trees and brush: dispose of off-site in accordance with all applicable codes and ordinances. Leave excavation free of roots and debris. Do not cause damage to trees not scheduled for removal.

3.3 Excavation

- A. Site Construction Areas: Strip off organic top soil and stock pile that amount needed to complete the work as shown on the site plan. Excess compactable soil and top soil to be removed from site.
- B. Depressions resulting from removal of obstructions: Where depressions result from, or have resulted from, the removal of surface or subsurface obstructions, open the depression to equipment working width and remove all debris and soft material as directed by the Architect or Soils Engineer.
- C. Remove any frozen soil prior to placement of any additional fill.
- D. Structure Excavation
1. Excavation: Remove all materials of every nature, description encountered, required, in obtaining indicated lines, grades, which, in Architect's opinion, can be loosened, removed by hand with hand tools, or with power shovels. Assume that all excavations to indicated lines, grades, can be done by aforementioned means. All excavated material will be removed from the Site except that material needed for backfill.

E. Excavating for Footings

1. Preparation

- a. To minimize differential settlement, it is essential that earth surfaces upon which footings will be placed be compacted to the acceptance of the Soils Engineer and in accord with the compaction requirements established in this Section of these Specifications.
- b. Verify that all compaction is complete and accepted by the Soils Engineer prior to excavating for footings.

2. Excavating

- a. Excavate to the established lines and grades.
- b. Cut off bottom of trenches level and then remove all loose soil.
- c. Where soft spots are encountered, remove all defective material and replace with lean concrete or suitable compacted fill.
- d. Bearing soil conditions to be verified by the Soils Engineer prior to concrete placement on same.

F. Below Floor Slabs and Adjacent Walks and Slabs:

1. Under all floor slabs and all adjacent walks and slabs, remove and replace the existing soil as required for finish subgrades.

G. Other Areas

1. Excavate to grades shown on the Drawings.
2. Where excavation grades are not shown on the Drawings, excavate as required to accommodate the installation.
3. On cut banks, neatly trim to the required finish surface as the cut progresses. As an alternative, the Contractor may leave the cuts full and the finish grade by mechanical or hand equipment to produce the finish surfaces as shown on the Drawings.

H. Overexcavation: Back fill and compact all overexcavated areas as specified for fill below and at no additional cost to the Owner.

I. Removal of Unsuitable Materials

1. Remove unsuitable material from within the limits of the work specified in this Section.
2. Stockpile materials meeting requirements for controlled fill.
3. Remove from the Site all rock larger than three inches in maximum dimension.

J. Proofrolling: Within the limits of the concrete slabs, and yard area, roads, and limestone areas per site plan and before placement of underslab fill, proofroll the existing grade in two mutually perpendicular directions. Proofrolling shall be accomplished by heavily loaded 25 ton minimum weight rubber-tired tandem-axle dump truck. Areas exhibiting excessive deflection shall be undercut and stabilized prior to constructing concrete slabs and pavements.

3.4 Trenching

A. General

1. Perform all trenching required for the installation of items where the trenching is not specifically described in other Sections of these Specifications.

2. Make all trenches open vertical construction with sufficient width to provide free working space at both sides of the trench and around the installed item as required for caulking, joining, backfilling and compacting.

B. Depth

1. Trench as required to provide the elevations shown on the Drawings.
2. Where elevations are not shown on the Drawings, trench to sufficient depth to give minimum of 18 inches of fill above the top of the pipe measured from the adjacent finished grade.

C. Correction of Faulty Grades: Where trench excavation is inadvertently carried below proper elevation, backfill with approved material compacted to provide a firm and unyielding subgrade and/or foundation to the approval of the Architect and at no additional cost to the Owner.

D. Grading and Stockpiling Trenched Material

1. Control the stockpiling of trenched material in a manner to prevent water running into excavations.
2. Do not obstruct the surface drainage but provide means whereby storm and waste waters are diverted into existing gutters, temporary drains, or surface drains.
3. Do not stockpile materials adjacent to open trenches.

3.5 Excavation Bracing and Sloping: The soil report indicates that sloping or bracing of the excavation walls may be necessary to prevent caving in excavations.

- A. Properly support all trenches in strict accord with all OSHA pertinent rules and regulations or local Codes, whichever is stricter. The Contractor will be responsible for the design of the bracing system. Employ a Registered Engineer for the design of all bracing systems.
- B. Brace, sheet and support walls in such a manner that they will be safe and that the ground alongside the excavation will not slide or settle, and that all existing improvements of every kind, whether on public or private property, will be fully protected from damage.
- C. In the event of damage to such improvement, immediately make all repairs and replacements necessary to the approval of the Architect and at no additional cost to the Owner.
- D. Arrange all bracing, sheeting and shoring so as to not place stress on any portion of the completed Work until the general construction thereof has proceeded far enough to provide sufficient strength.
Brace excavations along the existing buildings to prevent undermining of floor slabs and footings.
- E. Removal of Bracing: Exercise care in the drawing and removal of sheeting, shoring, bracing and timbering to prevent collapse or caving of the excavating faces being supported.

3.6 Unanticipated Subsurface Conditions: The Owner has had a subsurface investigation performed by a soils engineer, the results of which are contained in the consultant's report. The Contractor acknowledges that he has reviewed the consultant's report and any addenda thereto and that his bid for earthwork operations is based on the subsurface conditions, as described in that report. At any point during earthwork, and foundation construction operations, that the contractor encounters conditions that are different than those anticipated by the Soils Engineer report, he shall immediately (within 24 hours) bring this fact to the Architect and Soil Engineer's attention. Once a fact of unanticipated conditions has been brought to the attention of the Owner, Architect, and the Soils Engineer has concurred, immediate negotiations will be undertaken between the Owner and the Contractor to arrive at a change in Contract price for additional work or reduction at a change in Contract price for additional work or reduction at a change in work because of the unanticipated conditions. The Contractor agrees that the unit prices shown on the Bid Form would apply for additional or reduced work under the Contract. For changed conditions for which unit prices are not provided, the additional work shall be paid for on a time and material basis.

3.7 Excess Water Control

- A. Unfavorable Weather
 - 1. Do not place, spread or roll any fill material during unfavorable weather conditions.
 - 2. Do not resume operations until moisture content and fill density are satisfactory to the Specifications.
- B. Flooding: Provide berms or channels to prevent flooding of subgrade; promptly remove all water collecting in depressions including foundation excavations.
- C. Softened subgrade: Where soil has been softened or eroded by flooding or placement during unfavorable weather, remove all damaged areas and recompact as specified for fill and compaction below. For softened foundation subgrade refer to Section 3.3 E.1.a.
- D. Dewatering: Provide and maintain at all times during construction, ample means and devices with which to promptly remove and dispose of all water from every source entering the excavations or other parts of the Work. Dewater by means which will ensure dry excavations and the preservation of the final lines and grades of bottoms of excavations.

3.8 Preparation of Subgrade

- A. Leveling: Remove all ruts, hummocks, and other uneven surfaces by surface grading prior to placement of fill.
- B. Wet Soil Conditions: At bearing elevations where unstable bearing soils are encountered for support of shallow foundations, over excavate and place at least a 6" layer of coarse crushed limestone to create a firm working base. Provide firm base for support of equipment described in Article 3.11 of this Section if required. Soils Engineer will review the base prior to concrete placement.

3.9 Backfilling

- A. Backfilling Prior to Approvals

1. Do not allow or cause any or the Work performed or installed to be covered up or enclosed by work of this Section prior to all required inspections, tests, and approvals.
2. Should any of the work be so enclosed or covered up before it has been approved, uncover all such work at no additional cost to the Owner.
3. After the work has been completely tested, inspected and approved, make all repairs and replacements necessary to restore the work to the condition in which it was found at the time uncovering, all at no additional cost to the Owner.

B. Filling

1. After subgrade compaction has been reviewed by the Architect, spread approved fill material in layers not exceeding nine inches in uncompacted thickness. Promptly backfill excavations as work permits, but not before concrete walls, piers, have attained full design strength, and are properly braced.
2. Bring each layer to the moisture content described herein prior compaction.
3. At fill banks, grade full and then compact at least five feet beyond the grade of the finish band. After the bands have been filled, trim to the finish grades and limits shown on the Drawings.

- C. Placing Granular Cushion: Carefully place and compact the granular cushion in areas to receive concrete slabs on grade, uniformly attaining the thickness indicated on the Drawings and providing all required transition planes.

3.10 Compaction

A. Moisture-conditioning

1. Water or aerate the fill material as necessary and thoroughly mix to obtain a moisture content which will permit proper compaction.
2. For all on-site clay soils designated to be compacted, bring to between minus 1 and 3 percent over optimum moisture content.
3. For all relatively non-expansive and predominately granular soils to be compacted, bring to within 2 percent below or above optimum moisture content.

- B. Compaction, General: Compact soil layer to at least the specified minimum degree; repeat compaction process until plan grade is attained. Percentage of compaction indicated shall be that percentage of maximum dry density obtainable by the ASTM designation D 698 method of compaction.

C. Degree of Compaction Requirements

1. Structural fill: Densify all structural fill, including recompacted existing fill and backfill, to a minimum degree of compaction of 95%.
2. Pavement areas: Compact the upper twelve (12) inches of fill in pavement areas to a minimum degree of compaction of 98%.
3. Trenches in building areas:
 - a. Building and pavement areas are defined, for the purpose of this Paragraph, as extending a minimum of five feet beyond the building and or/pavement.
 - b. Compact cohesive backfill material to a minimum degree of compaction of 95%.
 - c. Compact the upper twelve (12) inches of backfill in pavement areas to a minimum degree of compaction of 98%.
 - d. Densify cohesionless backfill material to a minimum relative density of 70% as determined by the ASTM test designated as D 2049.

3. At the upper two feet in areas to receive planting, compact to at least 90% maximum dry density. Compact all fill in these areas, beneath the upper two feet, to 95% maximum dry density.
4. The base of all footing foundations supported on fill are to be compacted to a minimum of 98% of the maximum density.

D. Soil Compaction Control

1. Inspections: Contractor will notify the Soils Engineer daily before starting soil compaction. Contractor will not start any soil compaction without Soils Engineer approval. Soils Engineer will make daily inspection to insure proper compaction. Any material found to be improperly compacted will be removed at the Soils Engineer direction.
2. Operators: All compaction will be performed only by qualified mechanics experienced in the use of equipment and techniques to be used.
3. Compaction methods: Compaction methods used must be accepted by the Architect and Soils Engineer prior to commencement of work. Contractor will be prepared to demonstrate any methods used prior to Architect's approval.
4. Samples and Test: The Owner will employ a qualified engineer to perform required site and laboratory tests to verify conformance of compaction requirements. Contractor will verify with Architect the nature of tests before starting work to assure sample can be taken in locations and at time interval required.

E. Flooding and Jetting: Compaction by flooding and jetting is expressly prohibited.

3.11 Site Access for Other Contractors: The General Contractor will determine during the bidding period and include in the Base Bid all costs required to provide access to the Site for:

- A. Precast concrete hauling and erection equipment.
- B. Concrete transportation and placing equipment.
- C. Structural steel erector.
- D. Mechanical Contractors.
- E. The above Contractors are not responsible for any sitework to get their equipment into position. The Architect will not hear of any excuses for the General Contractor not having the Site accessible for these Contractors.

3.12 Surplus Earth Material: Stockpile all surplus earth, not needed to complete filling and grading, on the property and outside the limits of work as directed by the Architect. At completion of the project, remove from the site all surplus earth materials. See note at 3.3 A. same applies to excess excavated subgrade materials.

3.13 Grading

- A. General: Except as otherwise directed by the Architect, perform all rough and finish grading required to attain the elevations indicated on the Drawings.
- B. Treatment after completion of grading

1. After grading is completed and the Architect has finished his inspection, permit no further excavation, filling or grading except with the approval and inspection of the Architect.
2. Use all means necessary to prevent the erosion of freshly graded areas during construction and until such time as permanent drainage and erosion control measures have been installed.

3.14 Cleanup and Damage

- A. At completion of work, clean and remove from site all debris, materials from work, machines, etc.
- B. Any damage done to foundations, utilities, etc., by this Contractor, or his subcontractors, during work under this Contract, shall be repaired or replaced to the satisfaction of the Owner and Architect, without additional costs.

* * * * *

SECTION 32 90 00 LANDSCAPING

SCOPE Applicable provisions of the General and Supplementary Conditions and Division 1 govern work under this Section.

INDEX	1.1 Description	2.1 Materials
	1.2 Quality Assurance	3.1 Surface Conditions
	1.3 Submittals	3.2 Preparation
	1.4 Product Delivery, Storage and Handling	3.3 Installation
	1.5 Alternatives	3.4 Inspection
	1.6 Warranty	3.5 Maintenance

PART 1 GENERAL

1.1 Description

- A. Work Included: Planting required for this Work is indicated on the Drawings and, in general, includes planting and other ground cover throughout the Work.

1.2 Quality Assurance

- A. Qualifications of Installers: Provide at least one person who shall be present at all times during execution of this portion of the Work and who shall be thoroughly familiar with the type of materials being installed and the best methods for their installation and who shall direct all work performed under this Section.

B. Standards

1. All plants and planting material shall meet or exceed the specifications of Federal, State, and County laws requiring inspection for plant disease and insect control.
2. Quality and size shall conform with the current edition of "Horticultural Standards" for number one grade nursery stock as adopted by the American Association of Nurserymen.
3. All plants shall be true to name and one of each bundle or lot shall be tagged with the name and size of the plants in accord with the standards of practice of the American Association of Nurserymen. In all cases, botanical names shall take precedence over common names.
4. Substitutions: These will be permitted with written approval if good cause can be given as to why they must be made.

1.3 Submittals: Within 35 days after award of Contract, and before any of the materials of this Section are delivered to the job site, submit complete to the Architect in accordance with these Specifications; the following:

- A. Materials List: Submit a complete list of all plants and other items proposed to be installed. Include complete data and source, size, and quality. This shall in no way be construed as permitting substitution for specific items described in the Drawings of these Specifications unless the substitution has been approved in advance by the Architect.

- B. As-built Drawings: During course of the installation, carefully record in red line on a print of the planting Drawings all changes made to the Planting system layout during installation.
- C. Maintenance Instruction: Send to Architect on completion of installation. Instructions should include lawn and plant watering requirements, lawn mowing, weed and aeration, plant pruning, fertilizing and raking.

1.4 Product Delivery, Storage and Handling

- A. Deliver all items to the site in their original containers with all labels intact and legible at time of Architect's inspection.
- B. Immediately remove from the site all plants that are not true to name and all materials that do not comply with the provisions of this Section of these Specifications.
- C. Use all means necessary to protect plant materials before, during and after installation and to protect the installed work and materials of all other trades.
- D. Provide adequate means for protection from damage through excessive erosion, flooding, heavy rains, etc.
- E. Replacements: If there is damage or rejection, immediately make all repairs and replacements necessary to the approval of the Architect and at no additional cost to the Owner.

1.5 Alternatives: The Work of this Section is affected by alternatives as described on the Drawings and in of these Specifications.

1.6 Warranty: The landscape contractor agrees to guarantee all plants for one year from the time of planting. This guarantee includes furnishing new plants, as well as the labor and materials for installation of replacements. The contractor will not be liable for losses due to vandalism or improper maintenance.

PART 2 PRODUCTS

2.1 Materials

- A. Fertilizer
 - 1. General: All fertilizer shall be a commercial balanced 16-8-8 fertilizer delivered to the site in bags labeled with the Manufacturer's guaranteed analysis.
 - 2. Special protection: If stored at the site, protect fertilizer from the elements at all times.
- B. Mulch: All mulch shall consist of standard size ground bark chips, 1/4 inch to one inch in size, and shall be mill-run chips of Douglas Fir bark, or as equal approved in advance by the Architect.
- C. Tree Stakes: Unless otherwise indicated on the Drawings, all tree stakes shall be redwood, construction heart grade, rough-sawn, two inches by two inches by eight feet long.
- D. Grass Seed

1. General: All grass seed shall be:
 - a. Free from noxious weed seeds and recleaned;
 - b. Grade A recent crop seed;
 - c. Treated with appropriate fungicide at time of mixing;
 - d. Delivered to the site in sealed containers with dealer's guaranteed analysis and season certification of weight, purity and germination.
 2. Proportions by weight:

a. Baron bluegrass:	20%
b. Majestic bluegrass	20%
c. Touchdown bluegrass	20%
d. Pennlawn fescue	20%
e. Fiesta rye grass	20%
f. Or approved equal	
- E. Topsoil: Good, clean, fertile, humus-bearing topsoil free of toxic materials, noxious weed, stones, clods or other objectionable materials. Soil brought in shall have a qualified commercial soil test approved by the Architect. Approved material from the site maybe used.
- F. Edging: Polyethylene edging similar to valley view's "Black Diamond" bed divider.
- G. Plant Materials
1. Size: Plant materials will conform to the sizes given in the plant list and will be of a minimum size or larger. All measurements of spread, height, caliper, ball size and etc., will be in accord with the "USA Standards for Nursery Stock".
 2. Quality: All plants will be healthy, vigorous and free from disease and insect pests. All plants will have normal, healthy root systems and be free of scars and blemishes. All trees must have straight trunks, unless noted as "clumps", with full crowns and good structures.
 3. Root protection: Plants designated B & B should be balled and burlapped, with firm, natural earth balls. Broken or loose balls should not be planted. Container grown plants should have a well established root system and have been growing in the container for a minimum of one year.
 4. Do not prune plants before delivery except as authorized by the Architect. In no case shall tress to topped before delivery.
 5. Plant materials shall be subject to approval by the Architect as to size, health, quality, character, etc.
 6. Measurements
 - a. Measure height and spread of specimen plant materials with branches in their normal position as indicated on Drawings or Plant List.
 - b. Measure caliper of trees 12 inches above surface of ground.
 - c. Where caliper or other dimensions of plant materials are omitted from Plant Lists, these plant materials shall be normal stock for type listed.
 - d. Plant materials larger than those specified may be supplied with approval of Architect if complying in all other respects and at no additional cost to Owner.
 - e. Shape and form: Plant materials shall be symmetrical or typical for variety and species and conform to measurements specified on Plant List.
 - f. Provide plant materials from a licensed nursery or other source that has been previously accepted by the Architect.
- H. Sod: Sod will be vigorous, well rooted, healthy turf free from disease, insects, pests and weeds. It should contain a mixture of improved bluegrass varieties.

- I. Other Materials: All other materials, not specifically described but required for a complete and proper planting installation, shall be as selected by the Contractor subject to the approval of the Architect.

PART 3 EXECUTION

3.1 Surface Conditions

A. Inspection

1. Before all Work of this Section, carefully inspect the installed work of all other trades and verify that all such work is complete to the point where this installation may properly commence.
2. Verify that all planting may be completed in accord with the original design and the reference standards.

B. Discrepancies

1. If there is discrepancy, immediately notify the Architect.
2. Do not proceed with installation in areas of discrepancy until all such discrepancies have been fully resolved.

3.2 Preparation

- A. Dimensions on Drawings are approximate. Before proceeding with work, carefully check and verify dimensions and quantities. Report variations between Drawings and site to the Architect before proceeding with work.
- B. Plant totals are for convenience only and are not guaranteed.
- C. All planting indicated on Drawings will be required unless indicated otherwise.

3.3 Installation

A. Finish Grading

1. The site will be brought to rough grade by the General Contractor. Finish grading will be done by landscaping contractor.
2. Make minor adjustments of finish grades at the direction of the Architect, if needed. Exterior planters shall receive a minimum of 2 feet of top soil.
3. Finish grading shall consist of:
 - a. Redistribution of any top soil stored on site and/or additional soil required to bring surface to proper elevation.
 - b. Tilling of planting, lawn and ground cover areas as specified.
 - c. After tilling, bring areas to uniform grade by floating or hand raking.
 - d. Slope grade around building away from walls for a distance of not less than 10' at a slope not less than 1/2" per foot, unless otherwise noted.
 - e. Surface drainage shall be directed in manner indicated on the Drawing or Site Plan by molding surface to facilitate the natural run-off of water. Fill low spots and pockets with top soil and grade to drain properly.
 - f. Finish grade of all planting, lawn and turf areas shall be 1-1/2 inches below grade of adjacent pavement of any kind.

B. Soil Preparation

1. All lawn and groundcover planting areas must receive a minimum of 3 inches of topsoil.
2. Report any unusual subsoil conditions requiring special treatment to Architect.
3. In all areas where shrubs, trees, ground covers or lawns are to be planted, an application of no less than 10 pounds of commercial fertilizer shall be thoroughly dug into the top 3 inches of soil at the above rate per 1,000 square feet. Work areas into a smooth and even grade.
4. During preliminary grading, weeds shall be dug out from all planting areas by their roots and removed from the site.
5. All rocks of undue size and nonconforming foreign matter such as building rubble, wire, cans, sticks, etc., shall be removed from the site.
6. Beds shall be raked smooth and put in first class condition before final acceptance by Architect.

C. Edging: The planting areas around the building will be separated from the lawn area by a polyethylene edging as shown on the Landscaping Plan.

D. Landscaping Headers

1. Provide headers and stakes where shown on Drawings.
2. Where specified, provide 2" x 6" headers, (or two pieces 1" x 6" laminated where a curve is shown), to separate lawn areas from planting areas unless otherwise shown on the Drawings.
3. Extend redwood headers 1/2 inch above grade and hold in place with 1' x 2' stakes of length necessary to extend into a solid earth a minimum of 12 inches. All stakes shall be of sound material, neatly pointed, driven vertically and securely nailed to headers. Space stakes as not to exceed four feet on center. Top of stakes shall be set 1/2 inch below the tops of headers and cut at an angle to slope away from header top.
4. Compact backfill on both sides of headers to the density of the undisturbed adjoining earth.
5. When metal headers are called for on the Drawings, install them in accord with Manufacturer's recommendations.

E. Planting Trees and Shrubs

1. General:
 - a. Plant nursery stock immediately upon delivery to the site and approval by the Architect except that, if this is not feasible, heel-in all bareroot and balled material with damp soil and protect from sun and wind.
 - b. Regularly water all nursery stock in containers and place them in a cool area protected from sun and drying winds.
2. Execution: Planting pits for all shrubs and evergreens should be at least 12 inches wider than the root ball to be planted. They should be at least 24 inches wider than the root balls for all trees. Provide for at least 6 inches of good topsoil below bottom of the ball of roots.
3. Plantings:
 - a. Do not plant trees and shrubs until all major construction operations are completed.
 - b. All plants will be set straight, at the correct alignment and at the same grade as before being transplanted. When properly placed, the plants should be gradually filled with fertile topsoil and well watered to settle the soil.

- c. Fertilizer: The recommended amount of an approved "time release" fertilizer (such as "Easy Grow" packets) will be placed in the planting hole while it is being backfilled.
 - d. Wrapping and guying: The trunks of all trees should be wrapped with an approved type of tree wrap. Guying of trees is not necessary if they do not sway or lean. Trees that do not remain straight and steady must be properly staked. Support shall consist of at least two 2" x 2" x 3 foot lumber stakes driven into hole base before backfill so as not to damage roots. Tie tree to stakes in at least two places (near top and in middle) with a rubber hose nailed to stake and applied in a figure eight to insure safe support.
 - e. Relocation of trees: If underground construction work or obstructions are encountered in excavation of tree holes, Architect will select alternate locations.
 - f. Space the ground cover plants evenly as indicated on the Drawings, staggering the spaces around shrubs and trees as well as in the open areas.
 - g. Mulching: In all planting areas, a 2 foot wide strip around the building and a circle 3 feet in diameter, around all trees in lawn areas, will be covered with a 3 inch layer of shredded hardwood bark.
 - h. Pruning: All trees and shrubs will be pruned to remove dead or injured twigs and branches and to compensate for the loss of roots from transplanting. The amount of pruning will be limited to the minimum necessary to not change the natural habit or shape of the plant.
4. Lawn - Sod
- a. Preparation
 - (1) Grade all seed beds, thoroughly removing all ridges and depressions and making all areas into smooth, continuous, firm planes that ensure proper drainage.
 - (2) Remove all soil lumps, rocks, and other deleterious material.
 - b. Fertilizing: Apply the specified fertilizer at the rate of 10 pounds per 1,000 square feet, raking lightly into the soil.
 - c. Sowing
 - (1) Sow with a seeder approved for that purpose by the Architect.
 - (2) Sow at the rate of five pounds per 1,000 square feet.
 - (3) Promptly after seeding, wet the seed bed thoroughly, keeping all areas moist throughout the germination period.
 - (4) Seeded areas may also be hydro-seeded.
 - d. Mulching: After sowing, rake or broom seed gently and roll area to firm in seed. After rolling, cover area evenly with a top dressing of clean straw or marsh hay.
 - e. After Mulching: Thoroughly water seeded areas with a fine spray. Reseed areas that do not show prompt germination at 15 day intervals until an acceptable stand of grass is assured.
 - f. Sodding
 - (1) Prepare and fertilize areas to be sodded as described above.
 - (2) Sod rolls should be fitted tightly with staggered joints when installed. It should then be rolled and watered adequately before any drying or shrinking of the sod can take place.
 - (3) After placement, fertilize sod at the rate of 10 pounds per 1,000 square feet.
 - g. Protection: Protect all turf areas by erecting temporary fences, barriers, signs, etc., as necessary to prevent trampling.

3.4 Inspection: Besides normal progress inspections, schedule and conduct the following formal inspections, giving the Architect at least 24 hours notice of readiness for inspection:

- A. Inspection of plants in containers before planting.
- B. Inspection of plant locations, to verify compliance with the Drawings.
- C. Final Inspection After Completion of Planting: Schedule this inspection sufficiently in advance, and in cooperation with the Architect, so that the final inspection may be conducted within 24 hours after completion of planting.
- D. Final inspection at the end of the maintenance period, provided that all previous deficiencies have been corrected.

3.5 Maintenance

- A. General: Maintain all planting and lawn areas, starting with the landscaping operations and continuing for 30 calendar days after all landscaping is complete and approved by the Architect.
- B. Work Included
 - 1. Maintenance shall include all watering, weeding, cultivating, spraying, and pruning necessary to keep the plant materials in a healthy growing condition and to keep the planted areas neat and attractive throughout the maintenance period.
 - 2. Provide all equipment and means for proper application of water to those planted areas not equipped with an irrigation system.
 - 3. Protect all planted areas against damage, including erosion and trespassing, by providing and maintaining proper safeguards.
 - 4. Mow lawn areas, if necessary, for not more than 14 days after installation.
- C. Replacements
 - 1. At the end of the maintenance period, all plant material shall be in a healthy growing condition
 - 2. During the maintenance period, should the appearance of any plant indicate weakness and probability of dying, immediately replace that plant with a new and healthy plant of the same type and size without additional cost to the Owner.
- D. Extension of Maintenance Period: Continue the maintenance period at no additional cost to the Owner until all previously noted deficiencies have been corrected, at which time the final inspection shall be made.

THIS PAGE LEFT INTENTIONALLY BLANK

SITE MAP

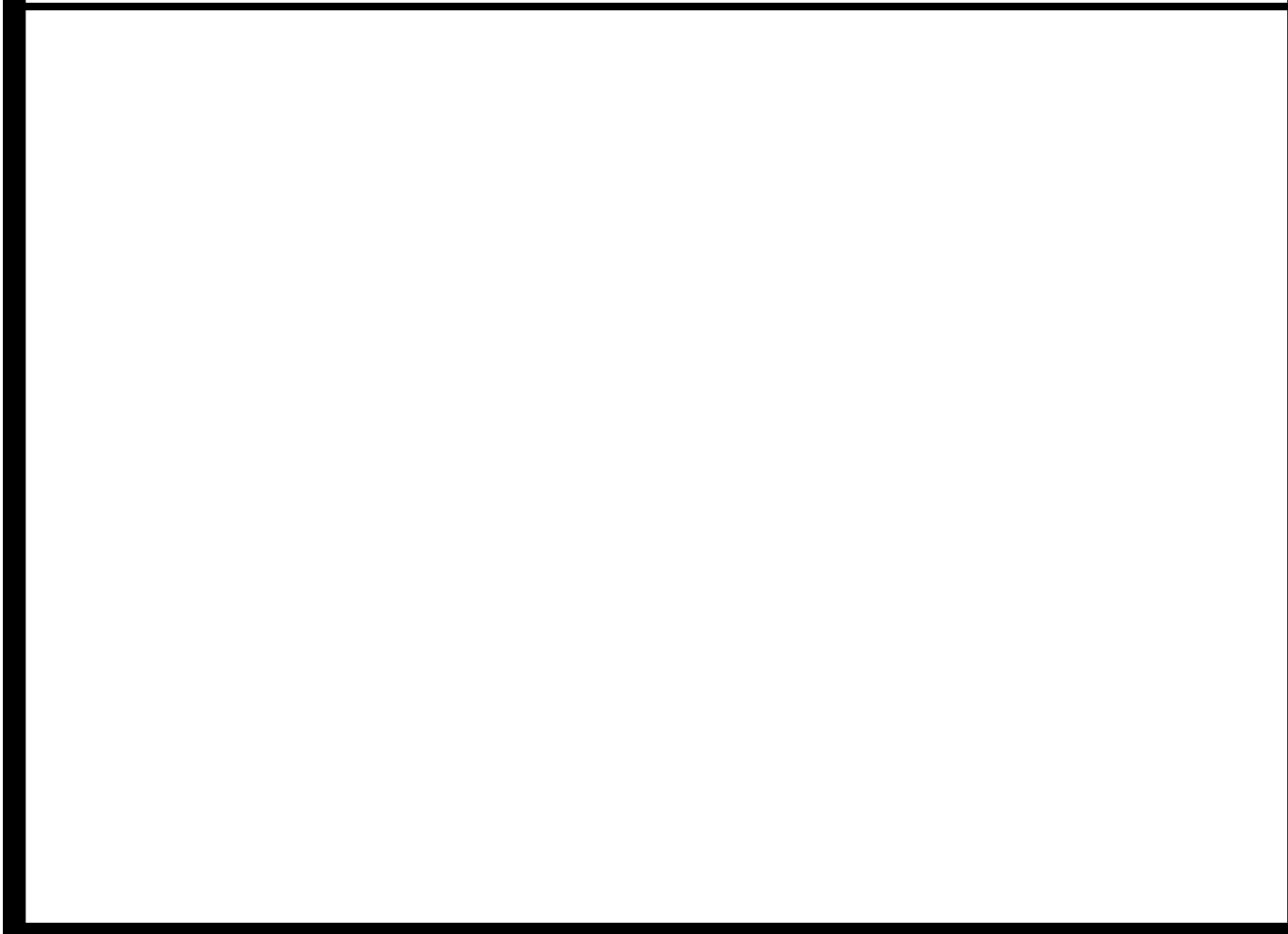

GENERAL NOTES

1. All concrete to test 4000 psi in 28 days.
2. Verify all dimensions, access, utilities and working conditions in the field.
3. Conform to all applicable codes, ordinances and safety standards.
4. Obtain and pay for all required permits and fees.
5. Notify Architect immediately if work cannot proceed as shown on Drawings or as described in the Specifications.
6. No concrete to be poured without Architect's prior review.
7. All Contractor's to co-operate with all trades, Owner's and Architect's representatives.
8. Leave site clean, neat and free of debris at all times.
9. Each Prime and Sub-contractor is responsible for having read each page of the Specifications, Drawings, Addenda and Change Orders.
10. Guard against interfering with Owner's operations.
11. These Drawings contain no provisions or procedures for on-site safety. Each Contractor and their employees are responsible to follow all laws and ordinances and provide their own engineering to provide a safe work place.
12. The locations of existing underground utilities, shown on these Drawings, are shown in an approximate way only and have not been independently verified by the Owner or its representatives. The Contractor shall determine the exact location of all existing utilities before commencing work, and agrees to be fully responsible for any and all damages which might be occasioned by the Contractor's failure to exactly locate and preserve any and all underground utilities.
13. Services perform for this project have been conducted in a manner consistent with the level of care and skill ordinarily exercised by members of the profession currently practicing in this area under similar budget and time constraints. No warranty, expressed or implied, is made.

MATERIAL INDICATIONS

Earth Backfill		Sand Fill	
Rigid Insulation		Concrete	
Concrete Block		Finished Wood	
Aluminum		Stone Fill	
Lumber (Rough)		Plywood	
Steel		Batt Insulation	

DRAWING LEGEND

+ 100.0	New or Required Point Elevation		Detail Number
+ 100.0	Existing Point Elevation		Page Number
+ 100.0	Existing Contours		Building Section
+ 100.0	New or Required Contours		Wall Section
A	Grid Lines		Detail Section
Room 1	Room/Space Number		Interior Elevation
10	Door Number		Exterior Elevation
1	Wall Tag		

CONSULTANTS

CIVIL	COMPANY NAME PHONE PROJECT MANAGER	ADDRESS
ARCHITECT	Kueny Architects 262-857-8101 Architect of Record - Jon P. Wallenkamp	10505 Corporate Drive Suite 100 Pleasant Prairie, Wisconsin 53158
PLUMBING	Southport Engineered Systems (262) 818-4409 Project Manager - Robert F. Novak	205 N. Dewey Street Eau Claire, Wisconsin 54703
H.V.A.C.	Southport Engineered Systems (262) 654-6630 Project Manager - Tim Pann	205 N. Dewey Street Eau Claire, Wisconsin 54703
ELECTRICAL	Hanson and Associates (262) 654-2012 Project Manager - David L. Hanson	6402 32nd Avenue Kenosha, Wisconsin 53142

SHEET INDEX

1.0	Title Sheet
ARCHITECTURAL	
A-101	Site Plan
A-201	Floor Plan and Roof Plan
A-202	Exterior Elevations
A-301	Building Sections
A-401	Wall Sections
A-402	Wall Sections
A-601	Room and Door Schedules
S-901	Foundation Plan and Details
S-902	Framing Plan and Details
PLUMBING	
P-204	Plumbing Plans and Schedules
MECHANICAL	
M-208	Mechanical Plan and Schedules
ELECTRICAL	
E-211	Satellite Building Electrical Plans
E-508	Schedules, Details

**Highway Facility Satellite Building
Dane County**

**US 151 and County
Highway V**

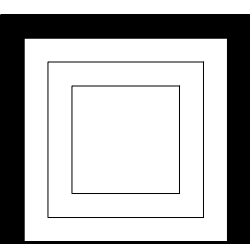

KUENY ARCHITECTS, LLC

10505 CORPORATE DRIVE - SUITE 100 PLEASANT PRAIRIE, WI 53158

PHONE (262) 857-8101 FAX (262) 857 8103

**Dane County
Highway Facility Satellite
Building
May 17, 2016**

1.0

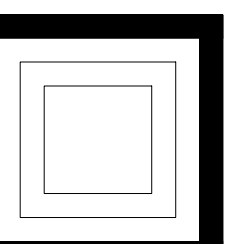

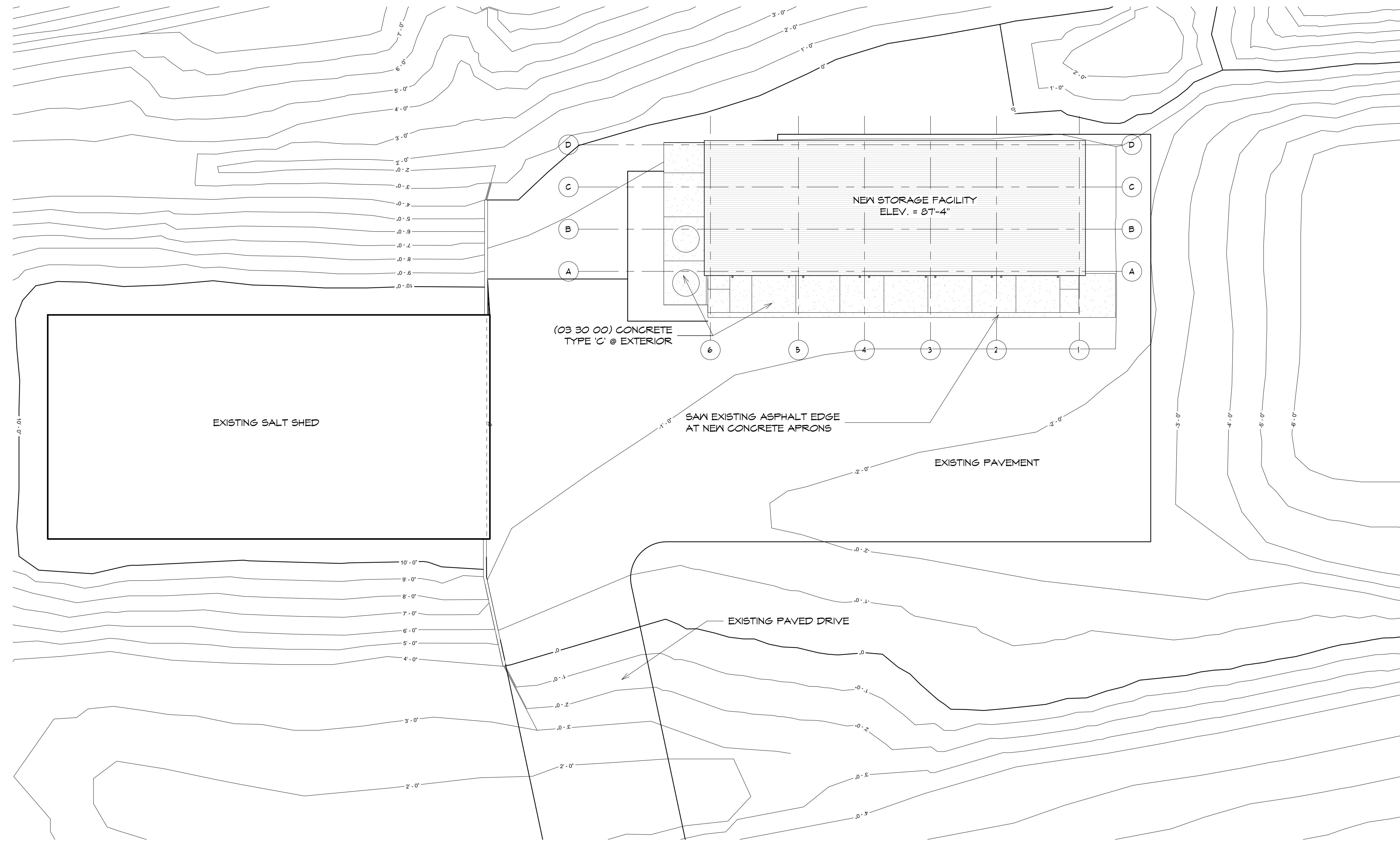

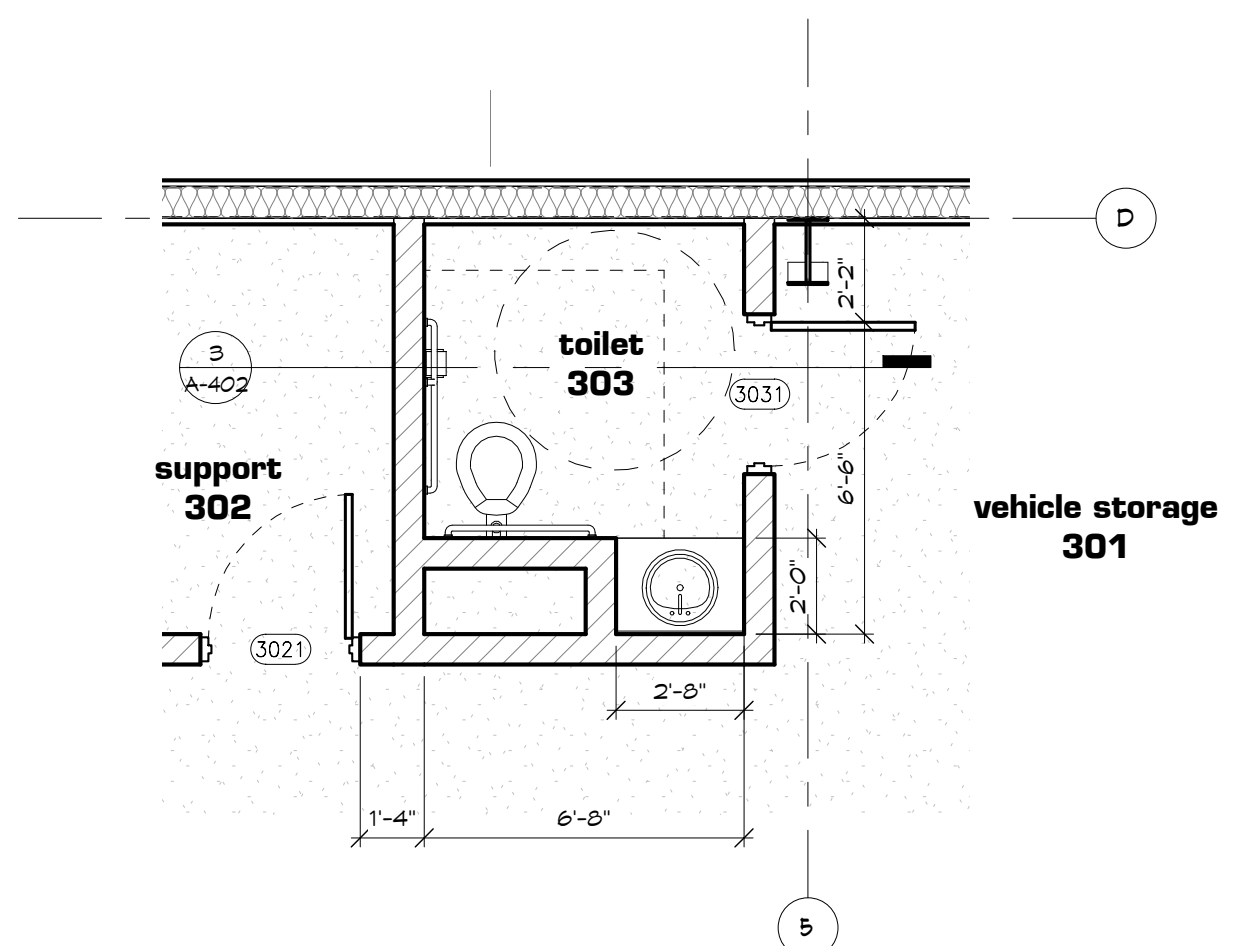

3 Future Enlarged Toilet Rooms
1/4" = 1'-0"

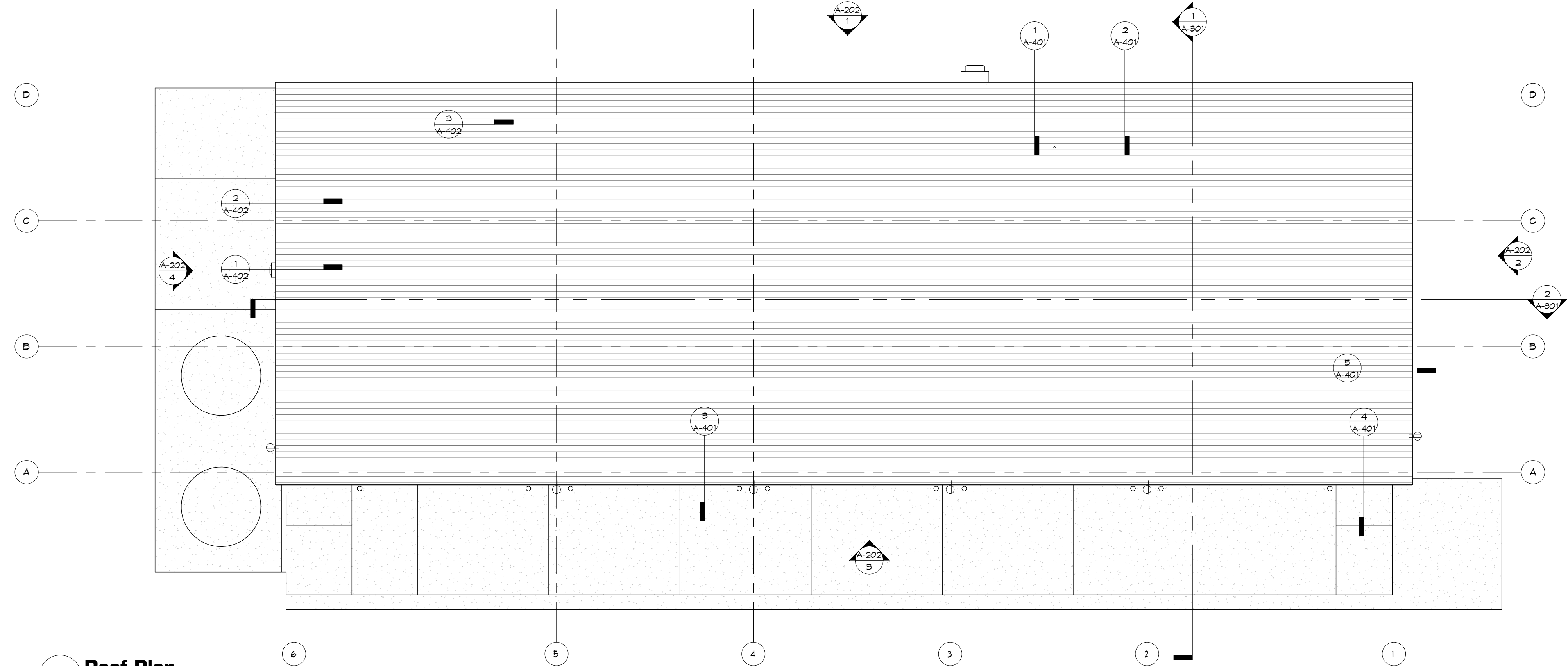

2 Roof Plan
1/8" = 1'-0"

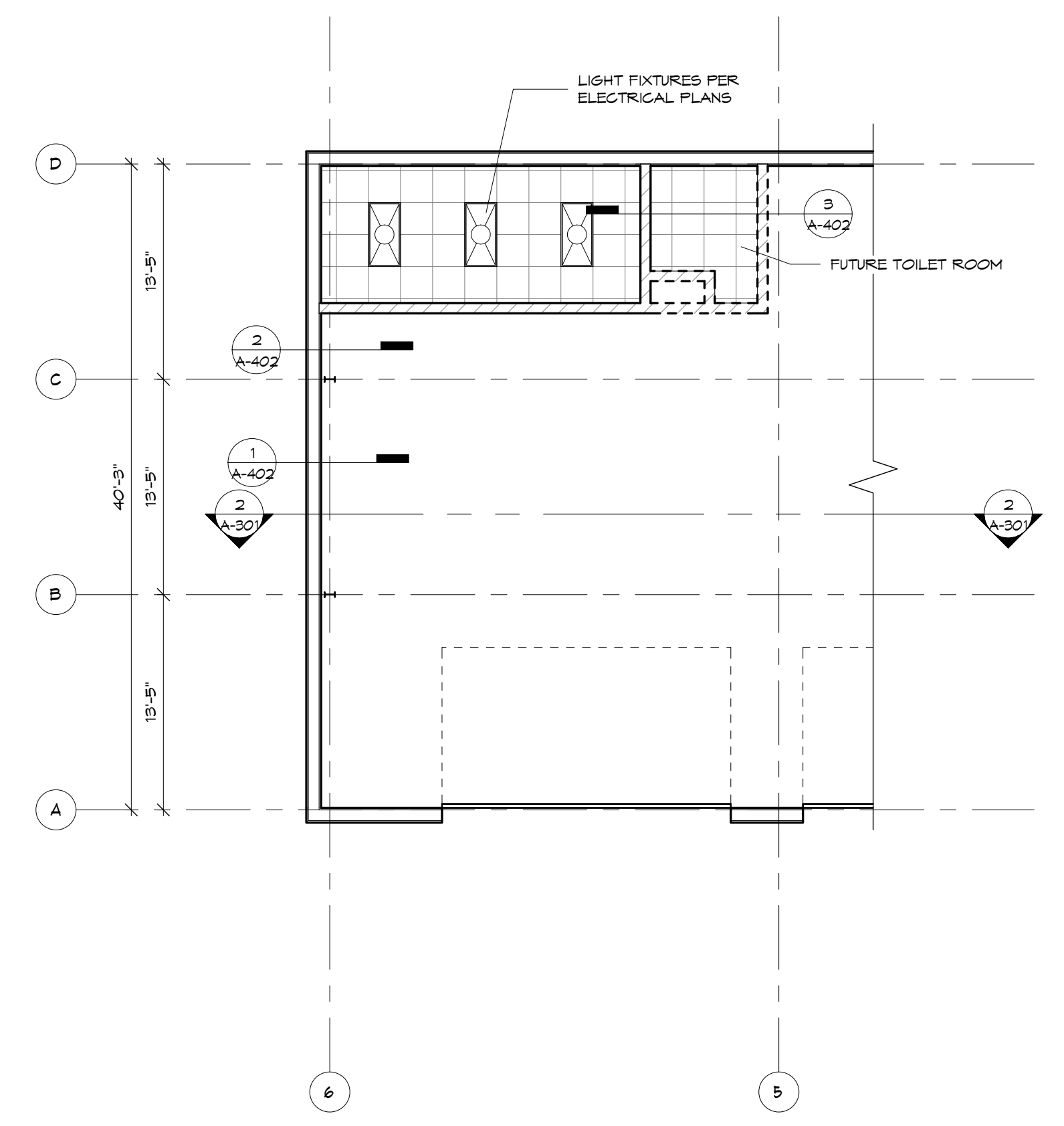

4 Reflected Ceiling Plan
1/8" = 1'-0"

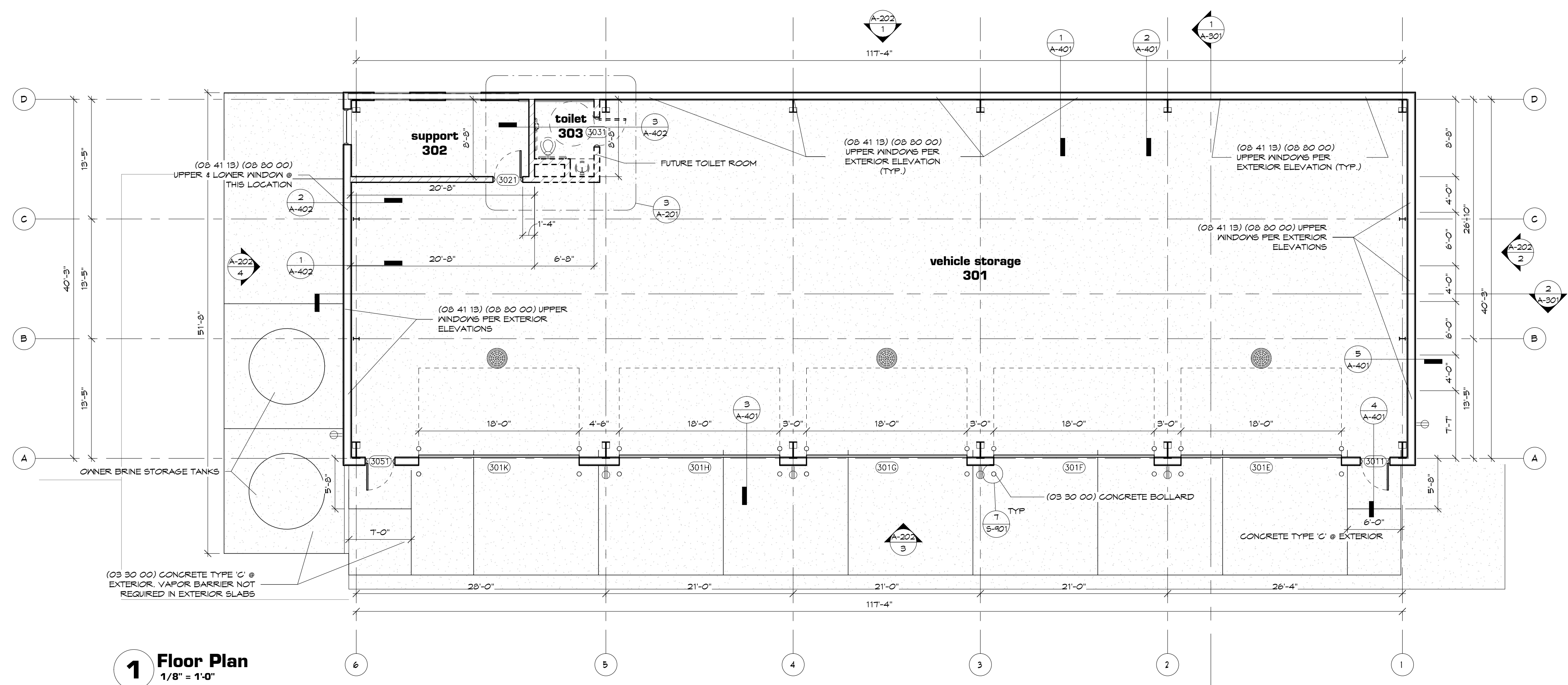

1 Floor Plan
1/8" = 1'-0"

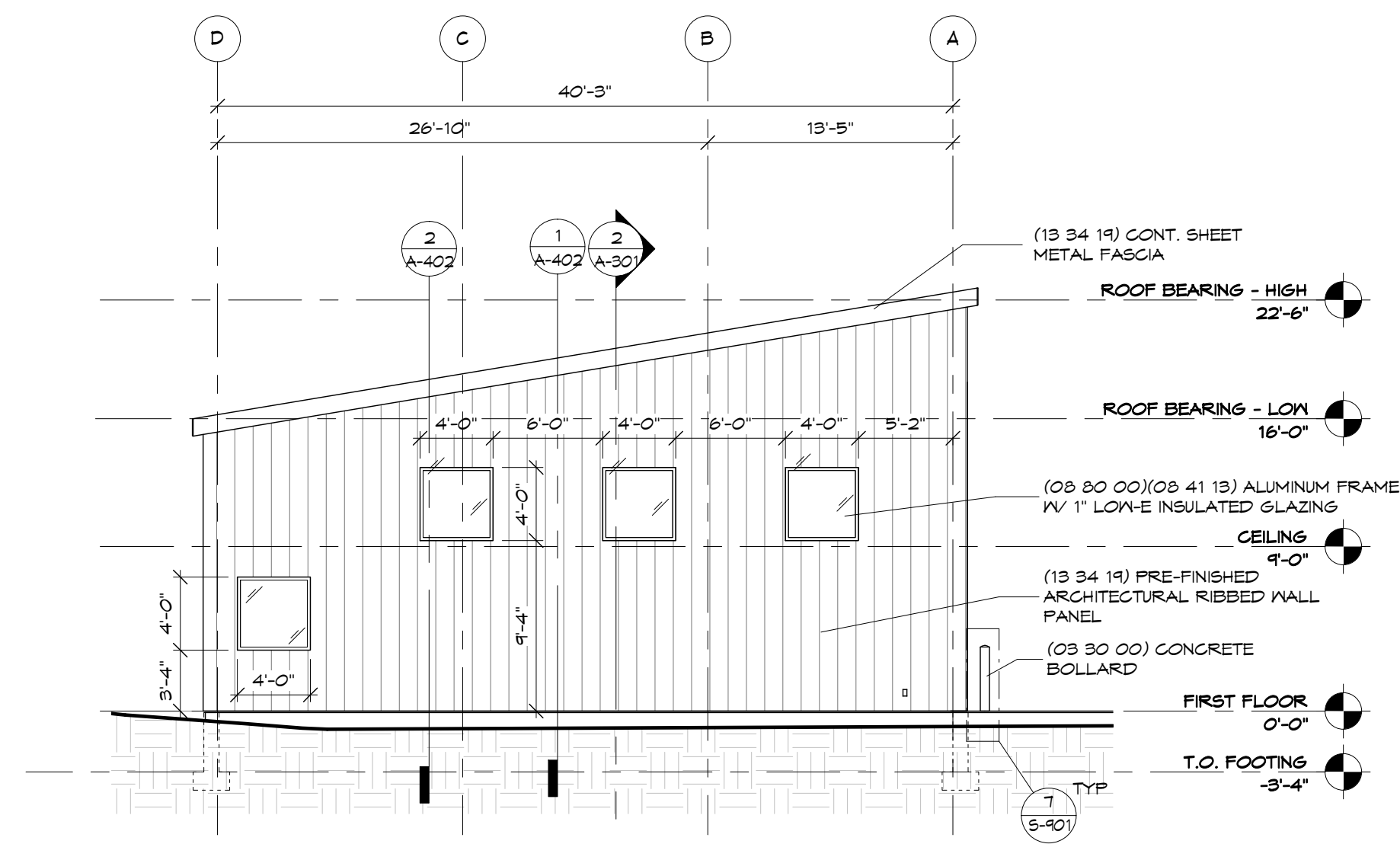

4 West Elevation
1/8" = 1'-0"

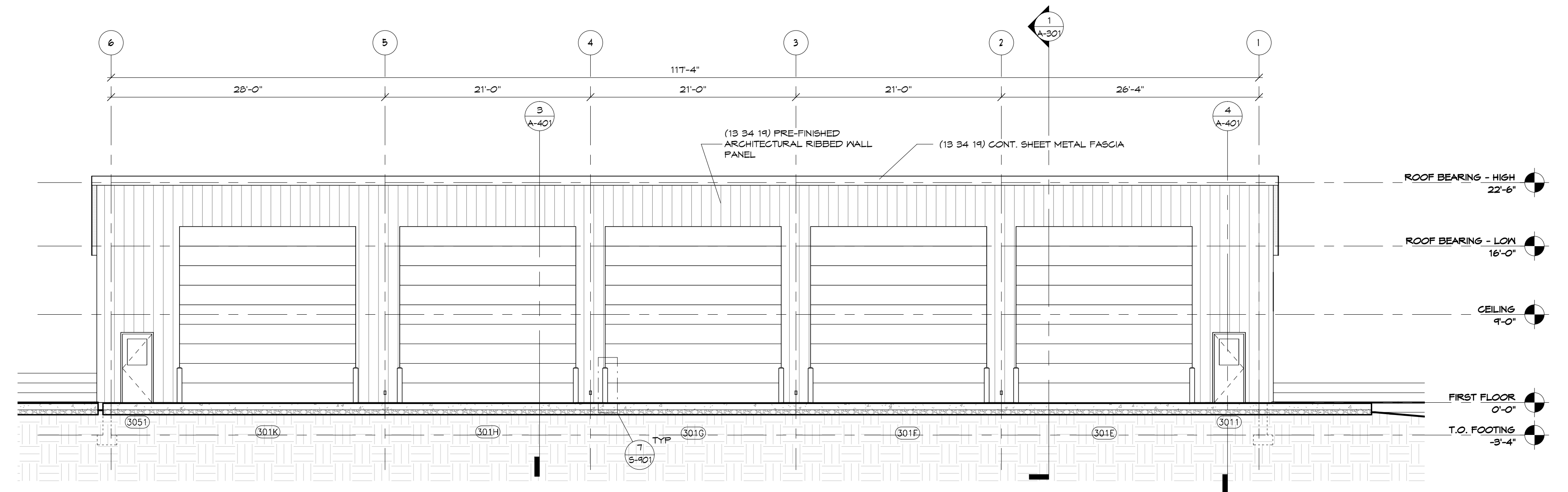

3 South Elevation
1/8" = 1'-0"

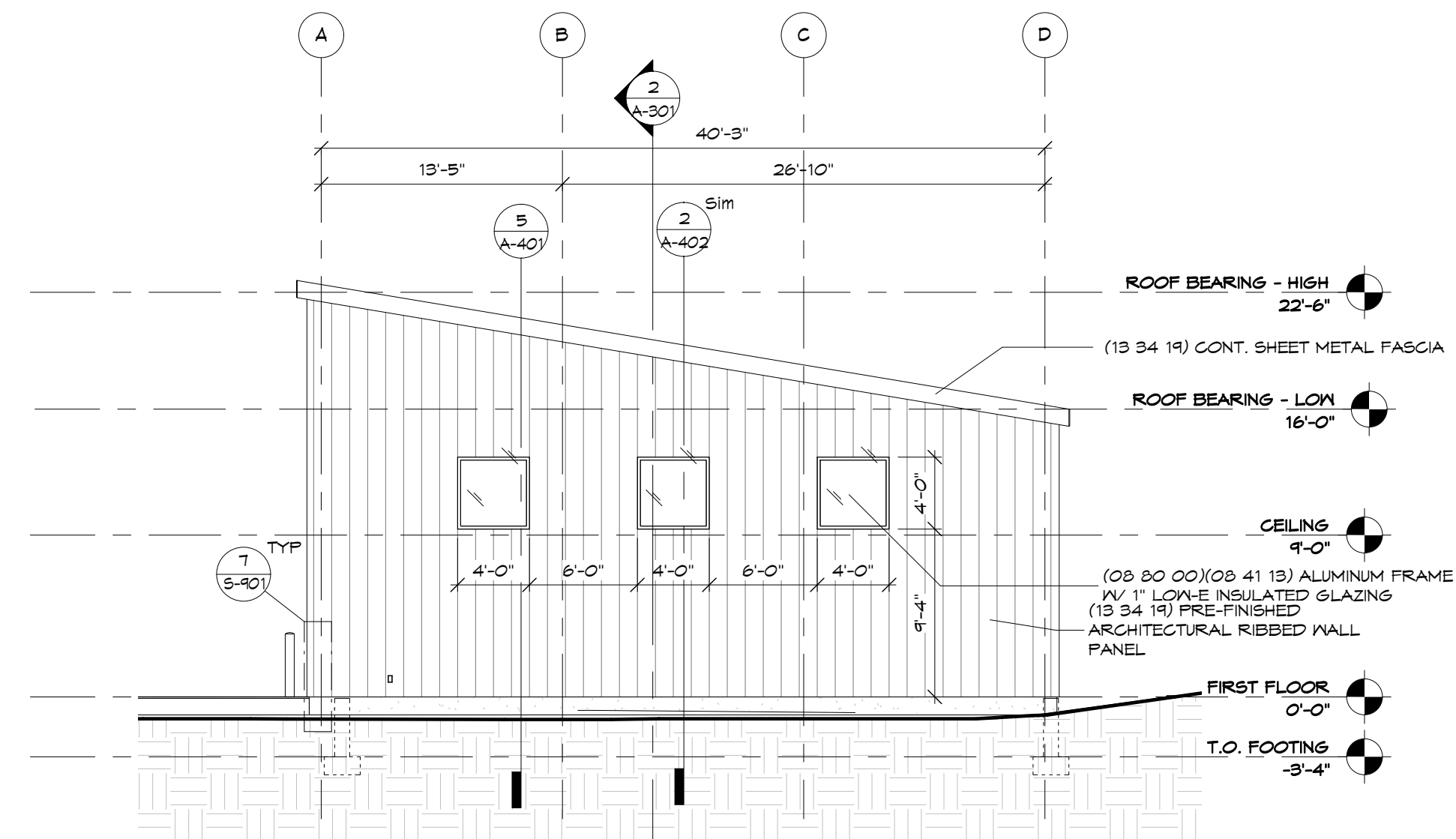

2 East Elevation
1/8" = 1'-0"

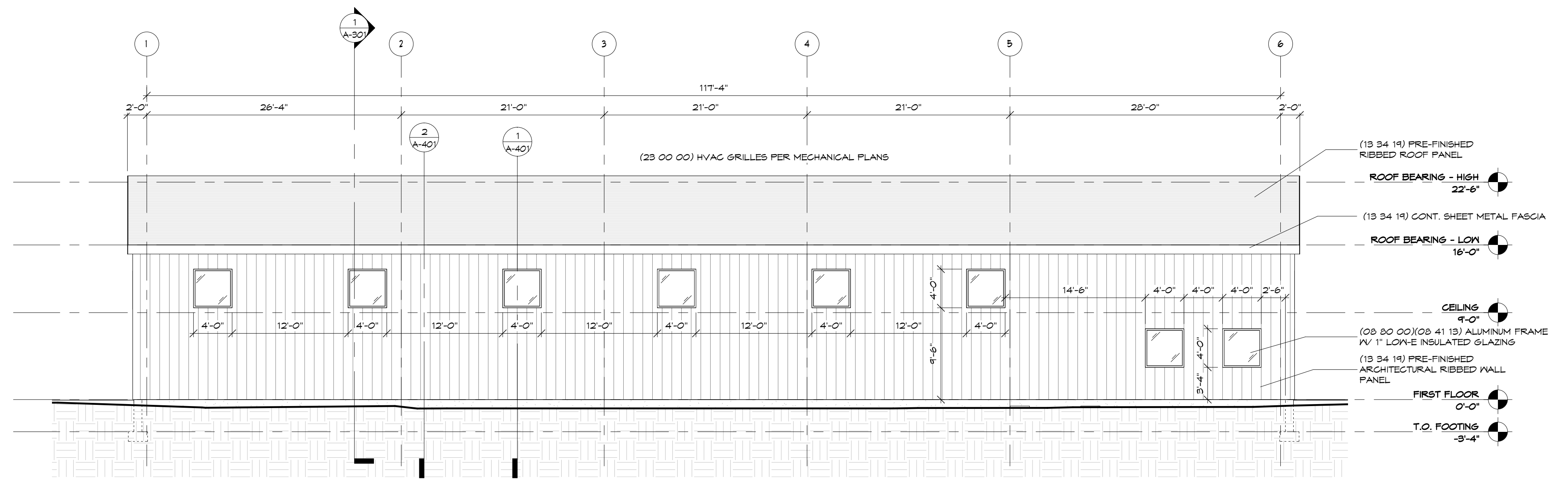

1 North Elevation
1/8" = 1'-0"

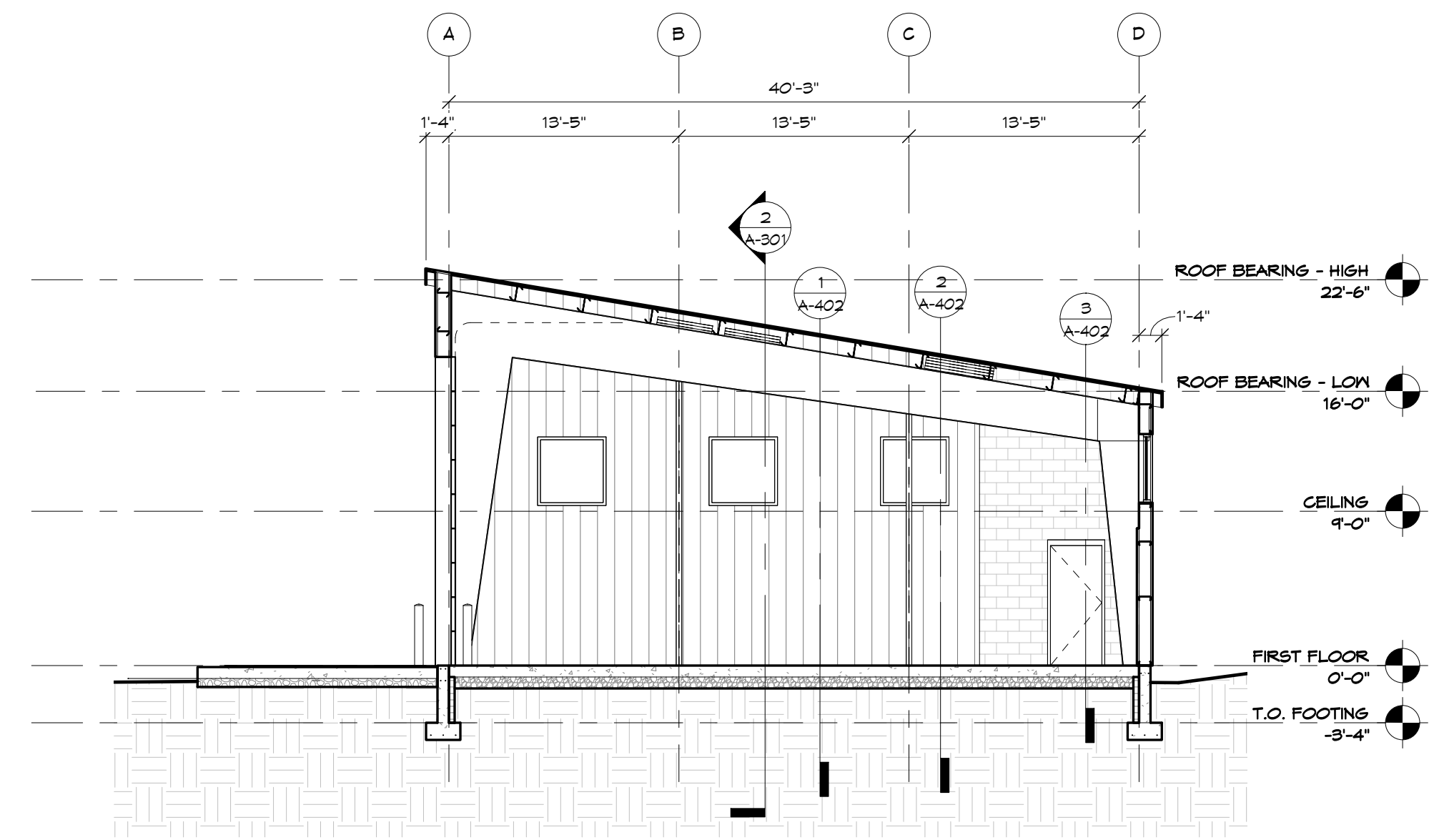

1 North-South Building Section
1/8" = 1'-0"

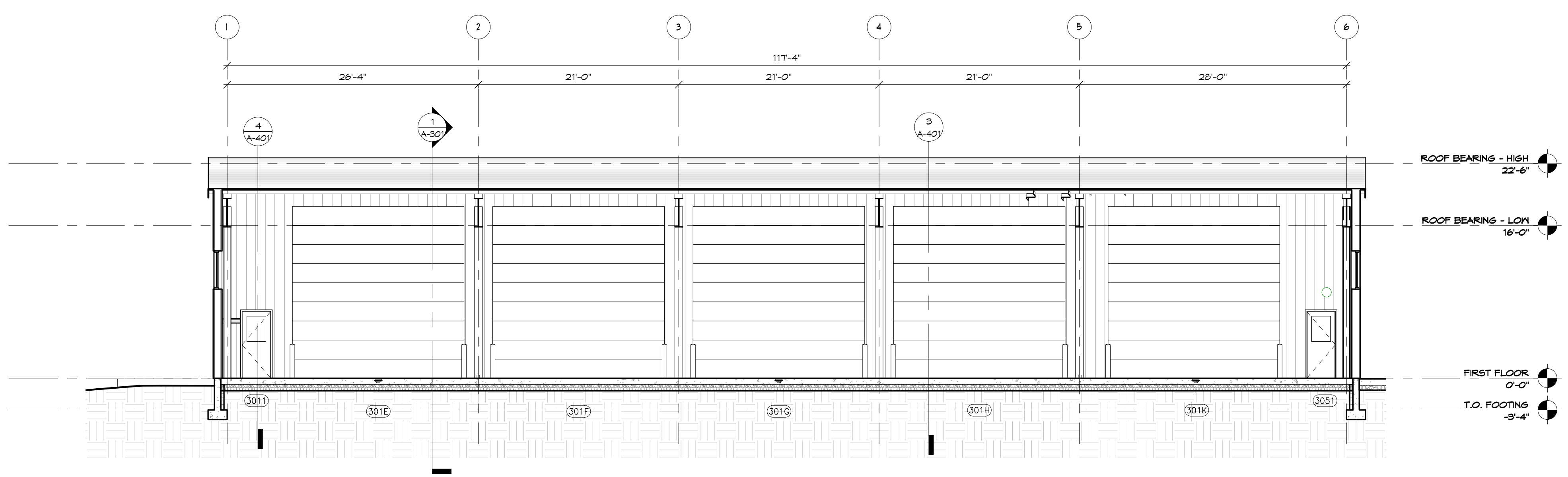

2 East-West Building Section
1/8" = 1'-0"

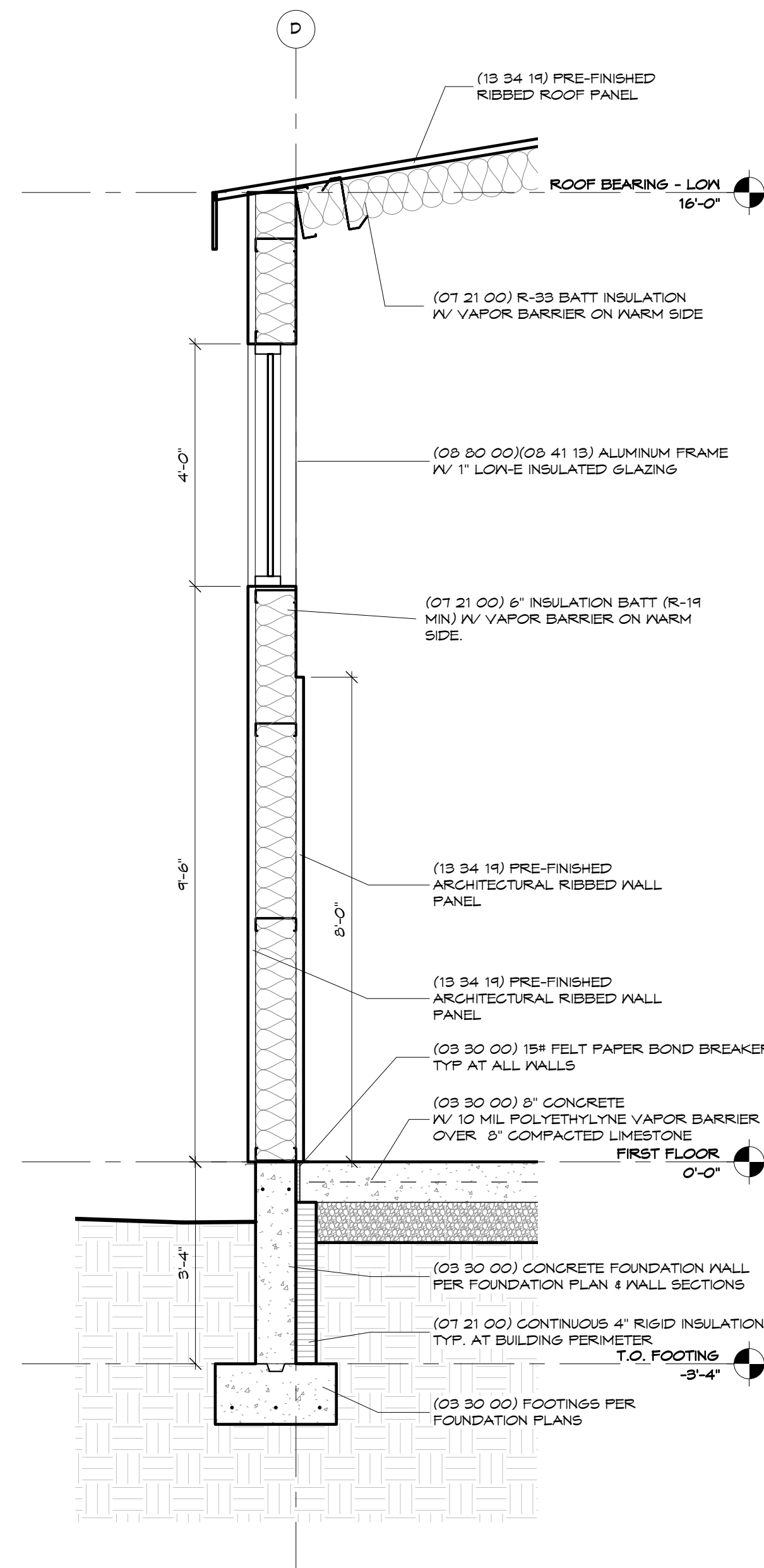

1 Wall Section
1/2" = 1'-0"

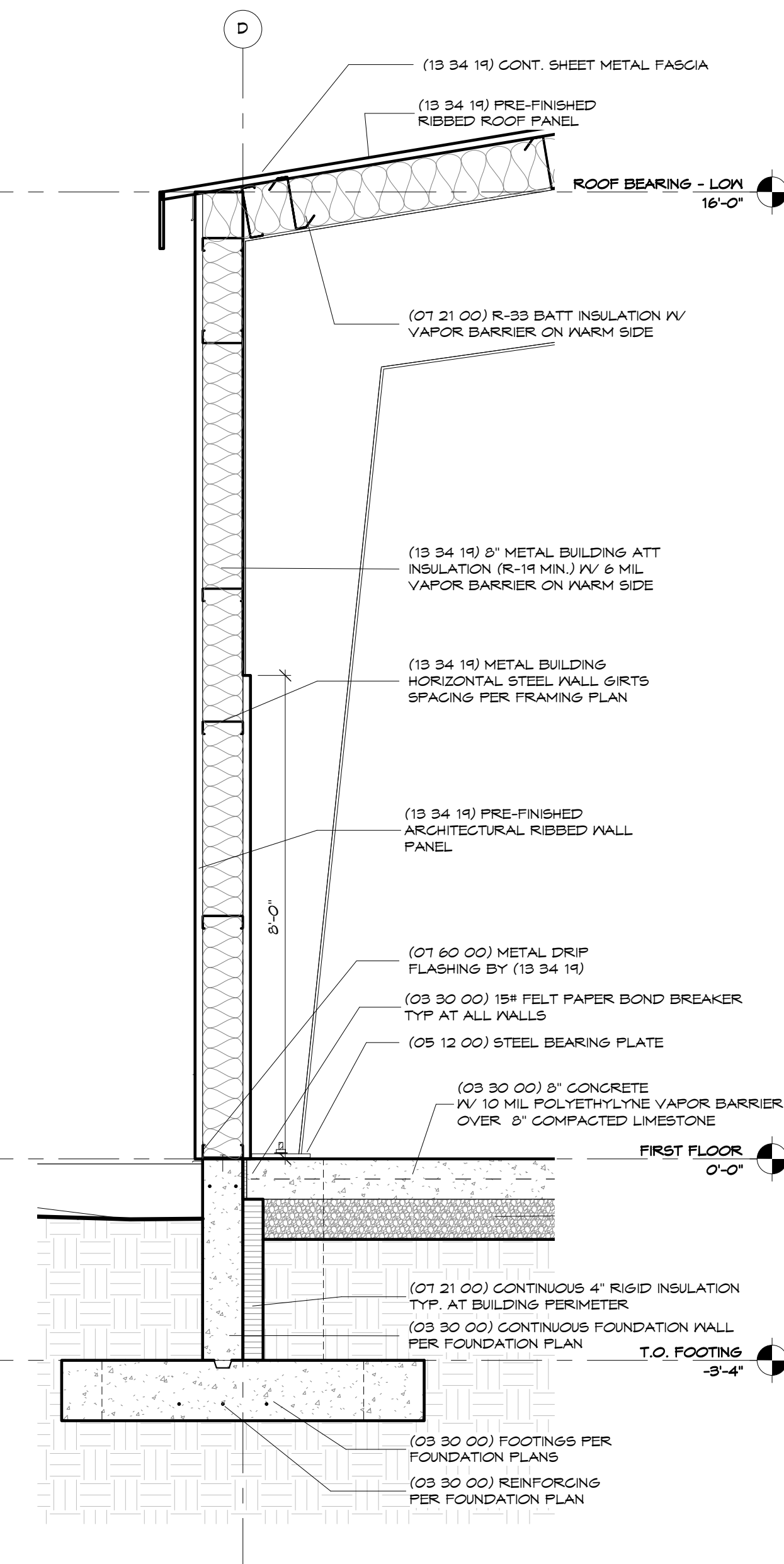

2 Wall Section
1/2" = 1'-0"

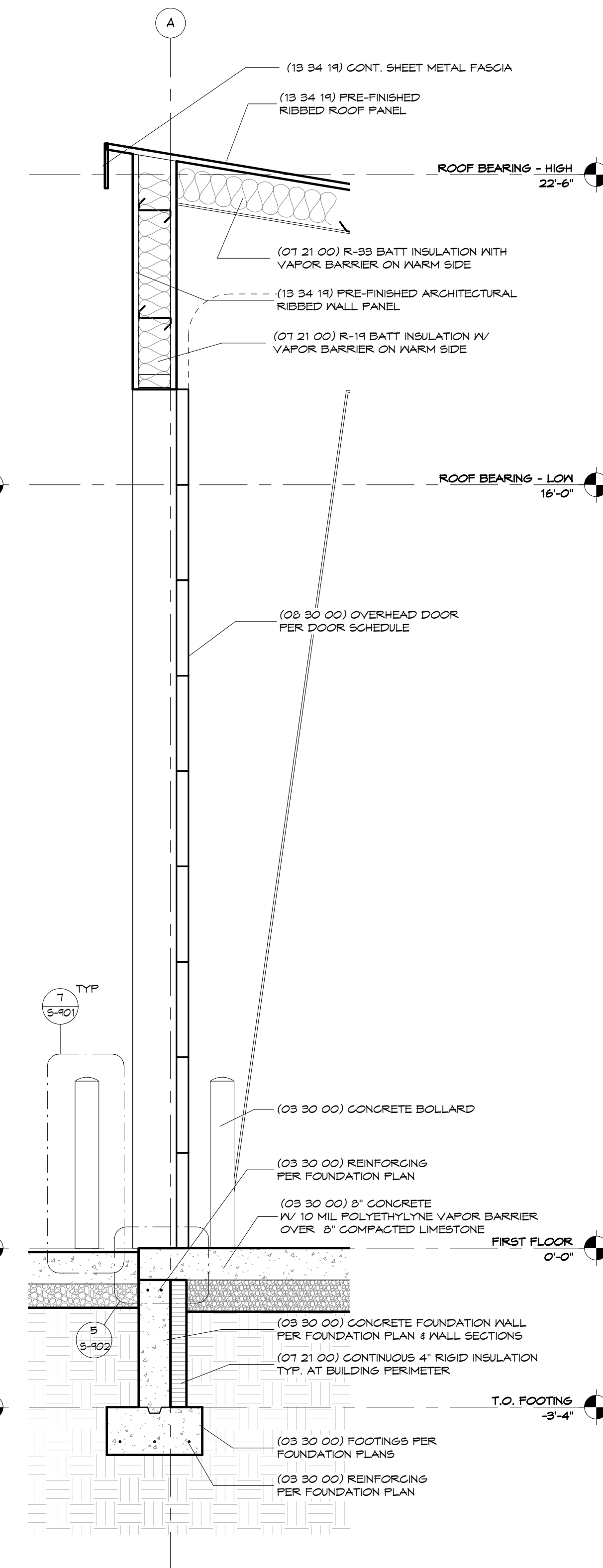

3 Wall Section
1/2" = 1'-0"

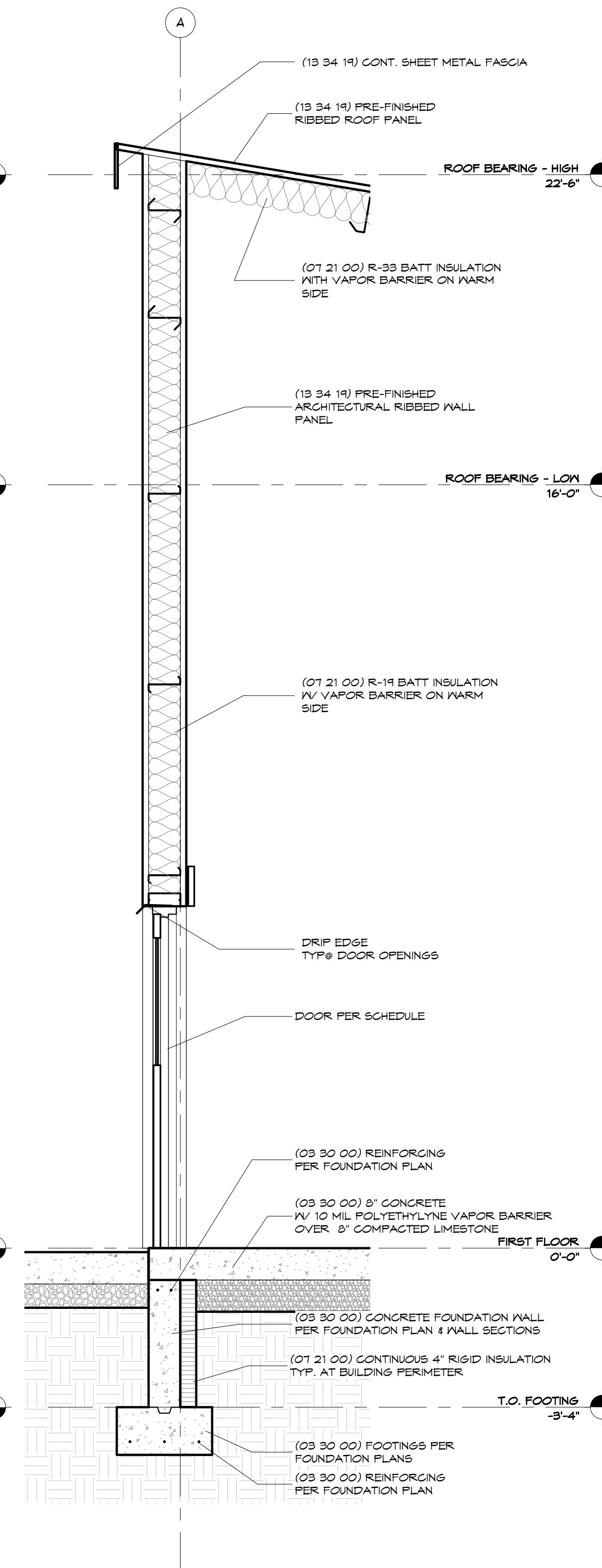

4 Wall Section
1/2" = 1'-0"

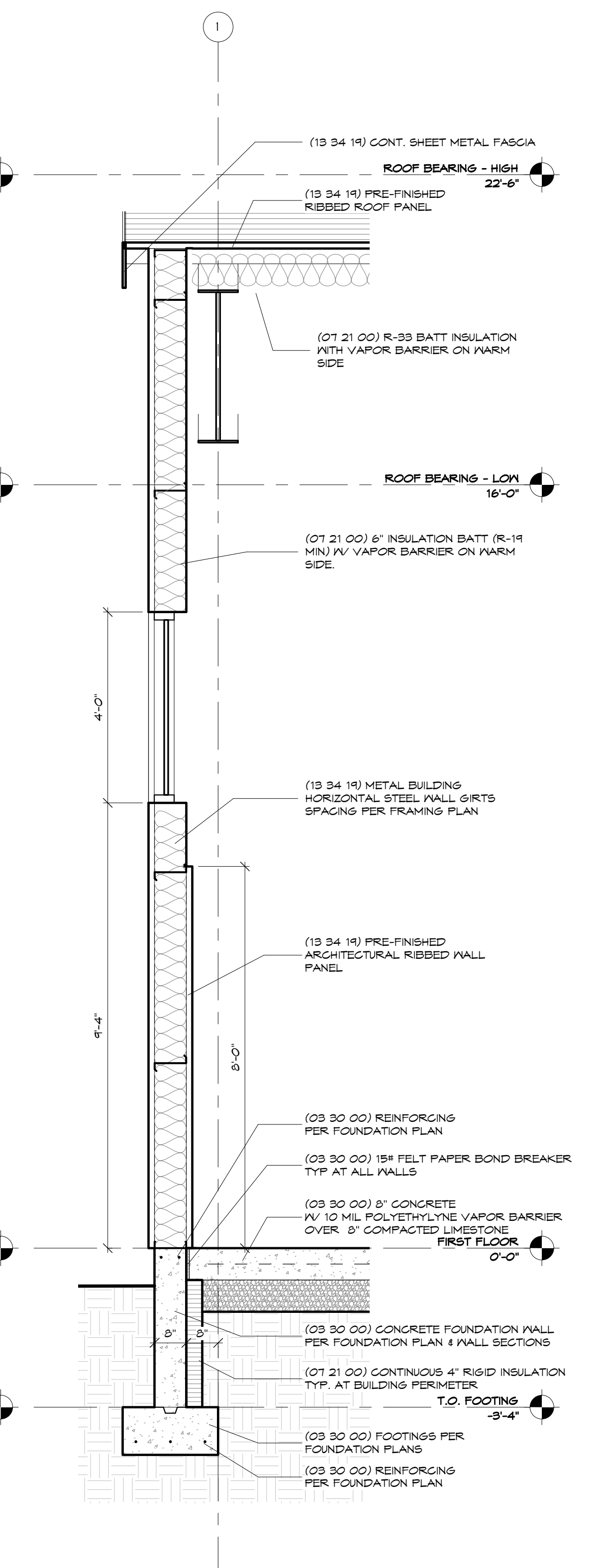

5 Wall Section
1/2" = 1'-0"

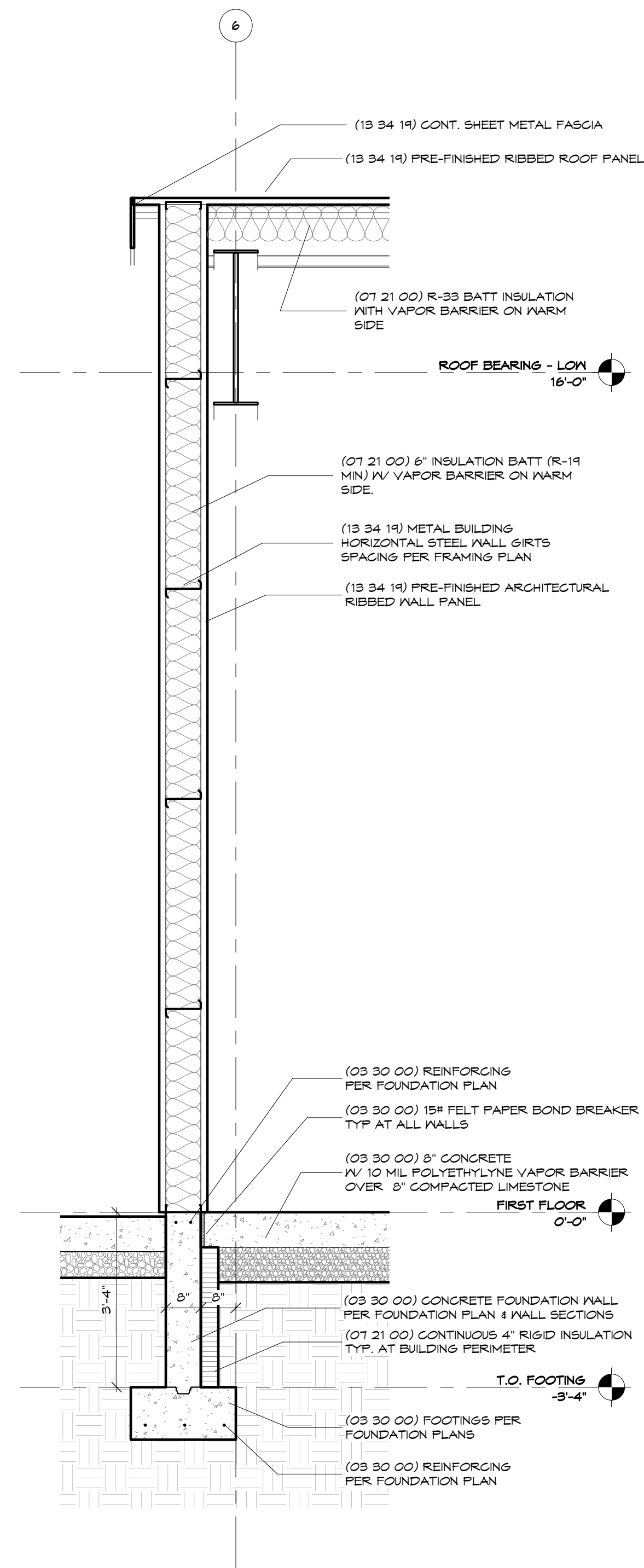

1 Wall Section
1/2" = 1'-0"

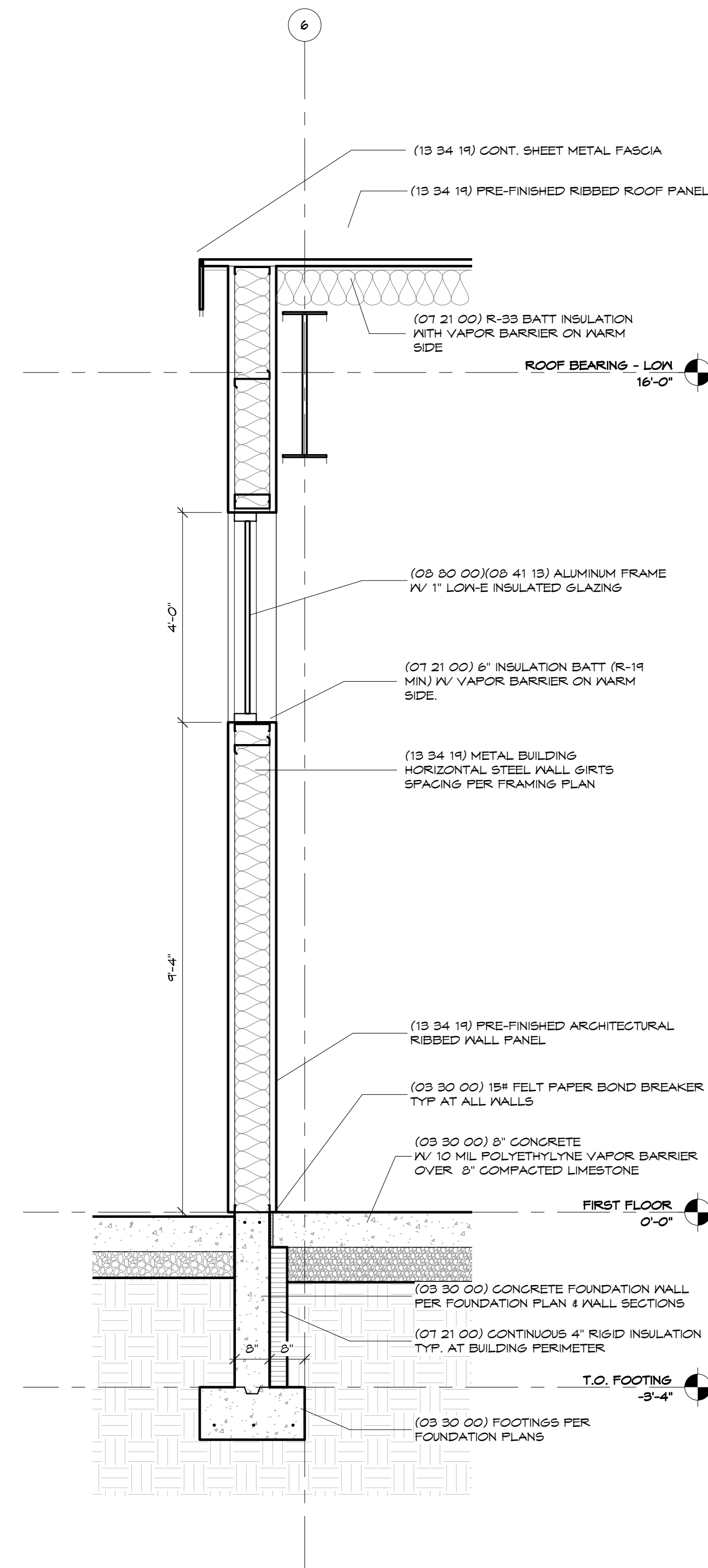

2 Wall Section
1/2" = 1'-0"

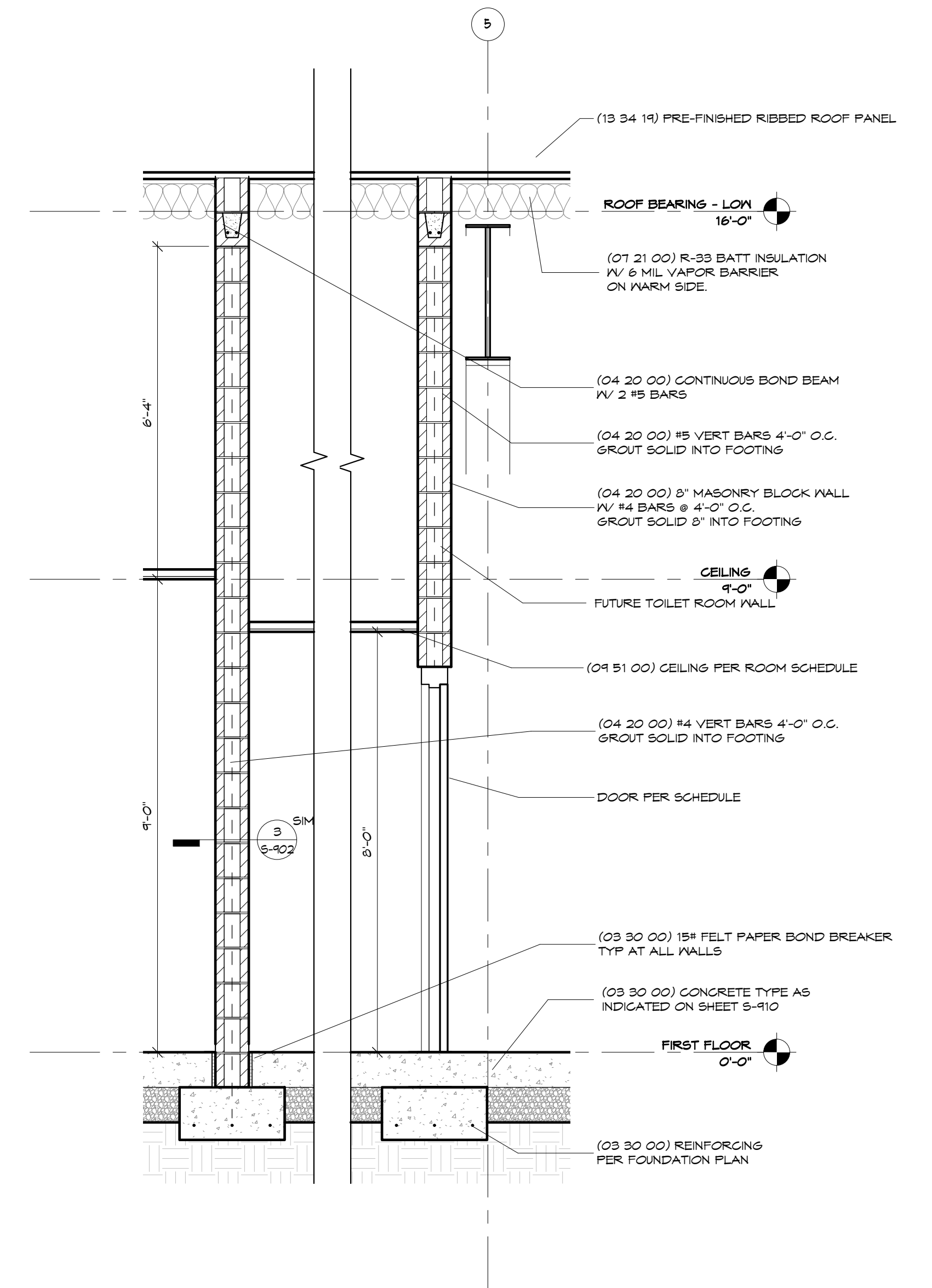

3 Wall Section
1/2" = 1'-0"

ROOM SCHEDULE										
NUMBER	NAME	FLOOR TYPE	BASE	WALL FINISH				CEILING		REMARKS
				NORTH	SOUTH	EAST	WEST	TYPE	HEIGHT	
301	vehicle storage	CONC	VB	MTL / GL-2	MTL	MTL / GL-2	MTL / GL-2	DRYFALL	VARIES	
302	support	CONC	VB	MTL / GL-2	CMU	CMU	MTL / GL-2	ACT-1	9'-0"	
303	toilet	CONC	VB	MTL	CMU	CMU	CMU	ACT-2	8'-0"	Future

PAINT SCHEDULE										
ROOM NUM	NAME	FLOOR	WALLS				CEILING	METAL	WOOD	REMARKS
			NORTH	SOUTH	EAST	WEST				
301	vehicle storage	Ashford	Latex-S	Latex-S	Latex-S	Latex-S	Dry/fall	Enamel	Varnish	
302	support	Ashford	Latex-S	Latex-S	Latex-S	Latex-S	ACT-1	Enamel	Varnish	
303	toilet	Ashford	Latex-S	Latex-S	Latex-S	Latex-S	ACT-2	Enamel	Varnish	Future

DOOR SCHEDULE																		
MARK	FROM ROOM		TO ROOM		DOOR							FRAME				REMARKS		
	NUM	NAME	NUM	NAME	TYPE	MATERIAL	SWING	LABEL	WIDTH	HEIGHT	THICKNESS	LOUVER	GLASS	TYPE	MATERIAL		LABEL	GLASS
3011	-	exterior	301	vehicle storage	HG	METAL	RHRB	-	3' - 0"	7' - 0"	1 3/4"	-	GL-2	A	METAL	-	-	-
3021	301	vehicle storage	302	support	HG	METAL	RH	-	3' - 0"	7' - 0"	1 3/4"	-	GL-1	A	METAL	-	-	-
3031	301	vehicle storage	303	toilet	F	METAL	RHRB	-	3' - 0"	7' - 0"	1 3/4"	-	-	B	METAL	-	-	FUTURE DOOR
3051	-	exterior	301	vehicle storage	HG	METAL	LHRB	-	3' - 0"	7' - 0"	1 3/4"	-	GL-2	A	METAL	-	-	-

HARDWARE SCHEDULE												
MARK	LOCKSET	PUSH-PULL	HOLD OPEN	CLOSER	HINGE	DOOR STOP	THRESHOLD	WEATHERSTRIPE	KICKPLATE	SOUNDSTOP	NAMEPLATE	NOTES
3011	Entrance	-	-	X	B.B.	-	-	X	X	X	-	OUTBUILDING
3021	Entrance	-	X	-	X	-	-	-	X	X	-	OUTBUILDING
3031	Privacy	-	-	X	B.B.	X	-	-	X	X	-	OUTBUILDING
3051	Entrance	-	-	X	B.B.	-	X	X	X	X	-	OUTBUILDING

OH DOOR SCHEDULE												
MARK	FROM ROOM		TO ROOM		DOOR						REMARKS	
	NUM	NAME	NUM	NAME	TYPE	R-Value	LABEL	WIDTH	HEIGHT	THICKNESS		GLASS
301E	-	exterior	301	vehicle storage	OH	R-17	-	18' - 0"	18' - 0"	3"	GL-2	Hardware by (08 30 00)
301F	-	exterior	301	vehicle storage	OH	R-17	-	18' - 0"	18' - 0"	3"	GL-2	Hardware by (08 30 00)
301G	-	exterior	301	vehicle storage	OH	R-17	-	18' - 0"	18' - 0"	3"	GL-2	Hardware by (08 30 00)
301H	-	exterior	301	vehicle storage	OH	R-17	-	18' - 0"	18' - 0"	3"	GL-2	Hardware by (08 30 00)
301K	-	exterior	301	vehicle storage	OH	R-17	-	18' - 0"	18' - 0"	3"	GL-2	Hardware by (08 30 00)

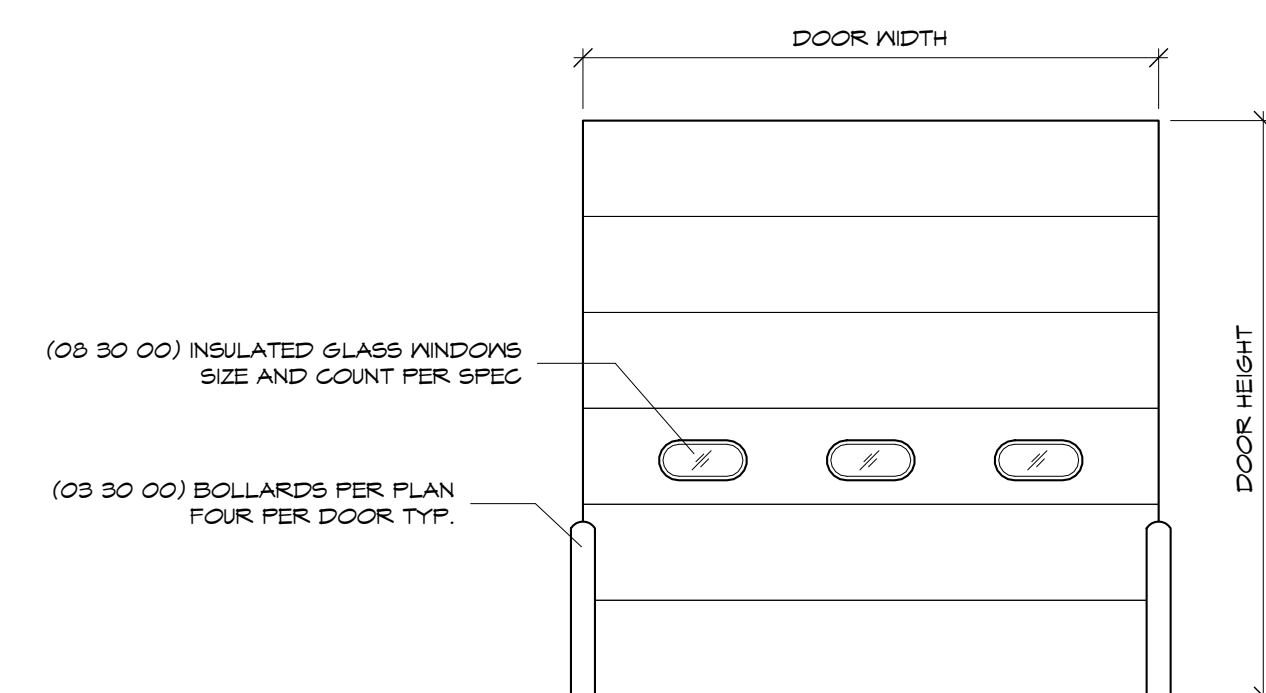

- SINGLE CYLINDER CLASSROOM LOCK
Deadbolt locked or unlocked by key from outside. Deadbolt unlocked by thumbturn only from inside.
- LEVER CLASSROOM LOCK
Outside lever locked and unlocked by key. Inside lever always unlocked.
- LEVER STOREROOM LOCK
Outside lever fixed, unlocked by key. Inside lever always unlocked.
- LEVER PRIVACY LOCK
Push-button locking. Can be opened from outside by emergency key, screwdriver, or similar tool.
- LEVER OFFICE LOCK
Push-button locking. Pushing button locks outside lever until unlocked by key outside or by turning inside lever.
- LEVER ENTRANCE LOCK
Turn/Push-button locking. Pushing and turning button locks outside lever requiring use of key until button is manually unlocked. Push-button locking. Push button locks outside lever until locked by outside key or by turning inside lever.
- COMBINATION LOCK
Outside lever fixed. Entrance by use of multi-digit combination. Inside lever always unlocked.

Lockset Types

MATERIAL KEY		
CODE	ITEM	DESCRIPTION
CEILING TYPE		
ACT-1	Acoustical Ceiling Tile	2x2 Acoustical Ceiling Panels (or 2x4 panels with 2x2 appearance)
ACT-2	Acoustical Ceiling Tile	2x2 Vinyl Faced Gypsum Panels
FLOOR TYPE		
CONC	Concrete	Sealed Concrete
CPT-1	Carpet	Carpet Tile
ECB	Epoxy	6" Epoxy Cove Base
EPOXY	Epoxy	Epoxy Resin Flooring
VB	Vinyl Base	4" Vinyl Base
PAINT SCHEDULE KEY		
EPOXY	PAINT	Epoxy Paint
LATEX-E	PAINT	Latex Wall Paint - Enamel
LATEX-S	PAINT	Latex Wall Paint - Satin Finish
WALL TYPE		
CMU	Concrete Masonry	Painted Concrete Masonry Unit
GL-1	Glass	3/8" Glass
GL-2	Glass	1" Insulated Glass
GWB1	Gypsum Wallboard	5/8" G.W.B. Taped and Finished on Stud Framing per Wall Type
GWB2	Gypsum Wallboard	5/8" Moisture & Mold Resistant Gypsum Wallboard Taped & Finished on Stud Framing per Wall Type
MTL	Metal Panel	Pre-finished Architectural Ribbed Wall Panel
TL	Ceramic Tile	6x6 Ceramic Wall Tile

Typ OH Door

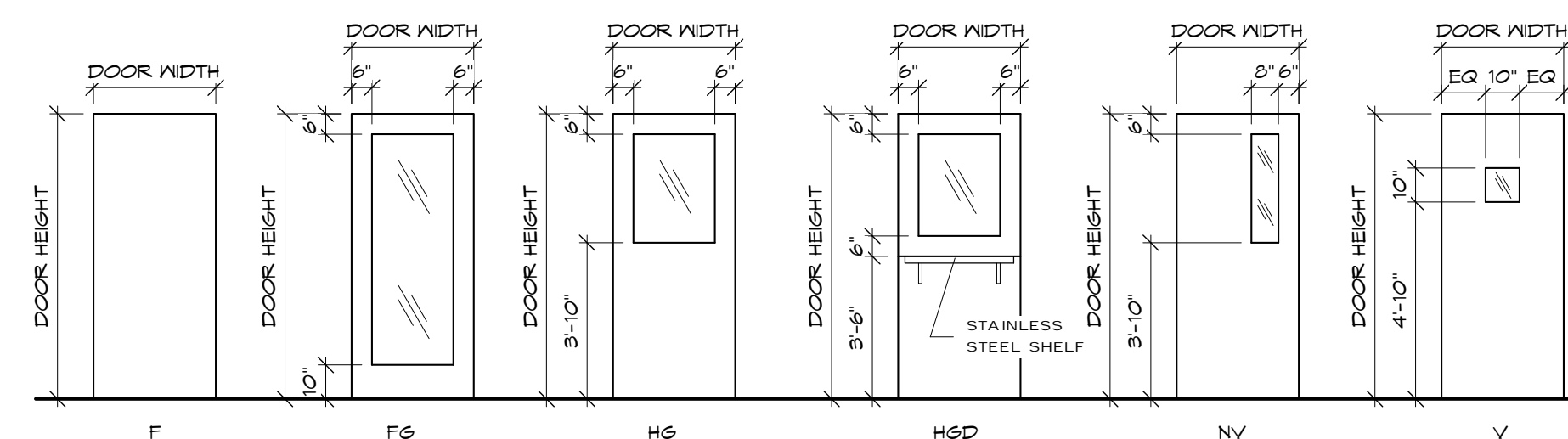

DOOR PANEL TYPES

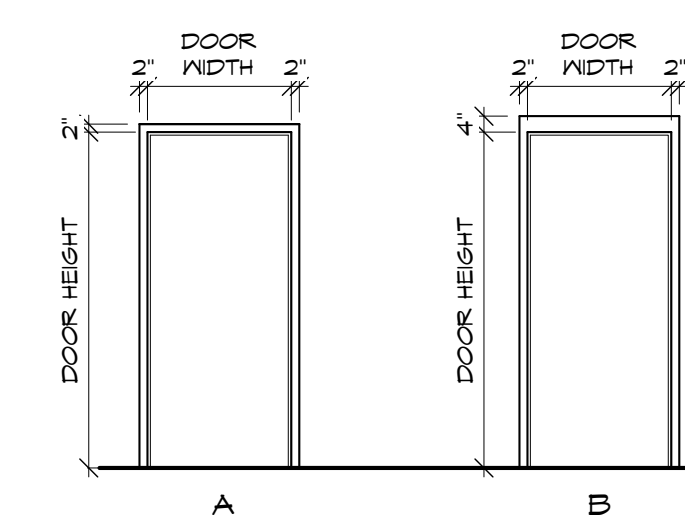

Door Frame Types

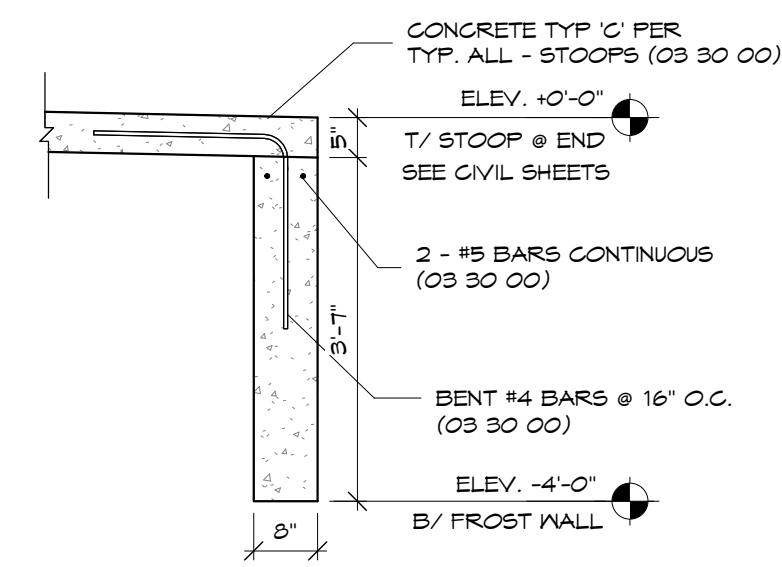

11 Stoop Frost Wall
1/2" = 1'-0"

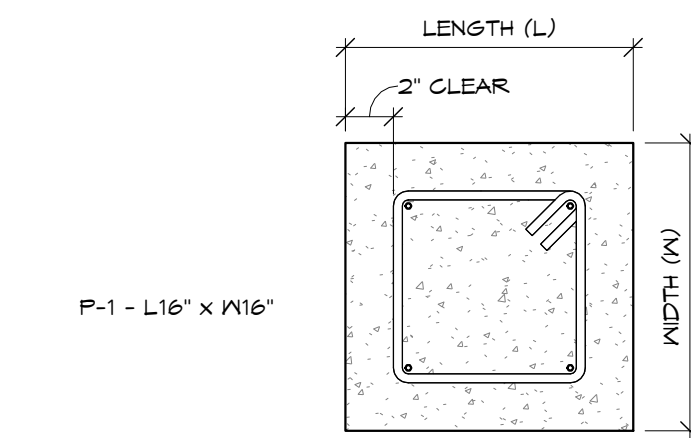

10 Pier Reinforcing Detail
1 1/2" = 1'-0"

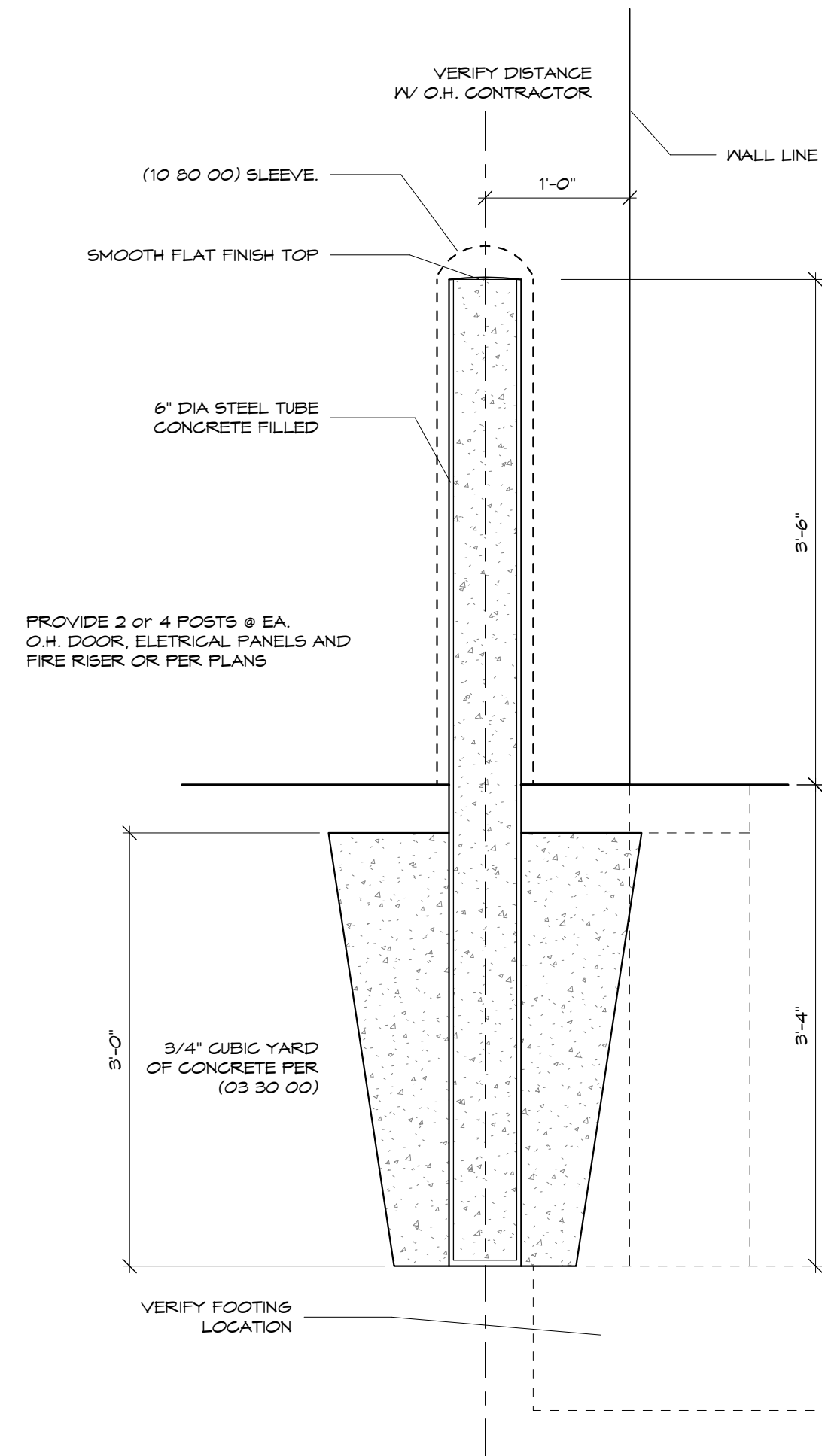

7 Concrete Bollard
1" = 1'-0"

LINTEL SCHEDULE			
MARK	TYPE	PLATE SIZE	REINFORCING AND END BEARING
L-1	2L3-1/2X3-1/2X1/4	7" X 1/4"	8"; GROUT SOLID THREE COURSES

FOOTING SCHEDULE		
MARK	SIZE	REINFORCING
ST-1	2'-0" X 1'-0"	3 - #5 BARS CONT.
F-2	6'-0" X 6'-0" X 1'-0"	5 - #5 BARS EACH WAY T&B
F-1	3'-6" X 3'-6" X 1'-0"	3 - #5 BARS EACH WAY T&B

PIER SCHEDULE			
MARK	SIZE	REINFORCING	TIES
P-1	1'-4" X 1'-4"	4 - #6 BARS VERTICAL	#3 BARS @ 16" O.C.

CONCRETE SLAB NOTES	
CONCRETE TYPE "A"	
4" CONCRETE SLAB - 6" X 6" X 1.4" X 1.4" W/F	
W/ 10 MIL POLYETHYLENE VAPOR BARRIER OVER 4" COMPACTED CRUSHED STONE	
CONCRETE TYPE "B"	
6" CONCRETE SLAB - 6" X 6" X 2.4" X 2.4" W/F	
W/ 10 MIL POLYETHYLENE VAPOR BARRIER OVER 6" COMPACTED CRUSHED STONE	
CONCRETE TYPE "C"	
8" CONCRETE W/ #3 EPOXY COATED REINF. @ 16" O.C. E.A.	
8" X 6" X 6" X 2.4" X 2.4" EPOXY COATED HIGHWAY MESH	
W/ 10 MIL POLYETHYLENE VAPOR BARRIER OVER 8" COMPACTED LIMESTONE	
#5 EPOXY COATED BARS REQ. @ EXPANSION JOINTS OR END OF CONSTRUCTION JOINTS 16" O.C. 2'-0" LONG	

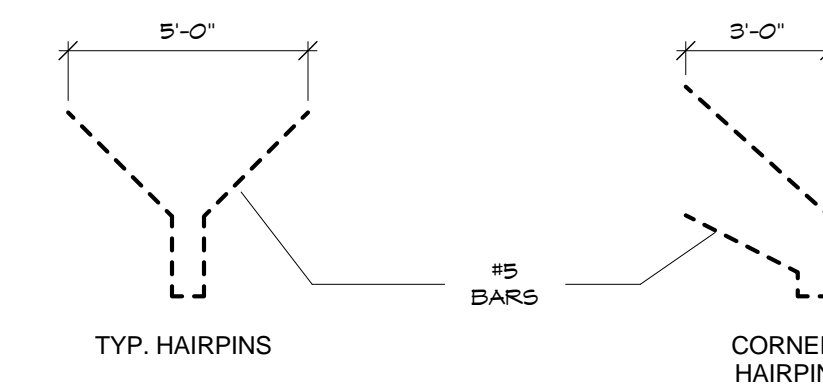

6 Typ. Hairpins
1/4" = 1'-0"

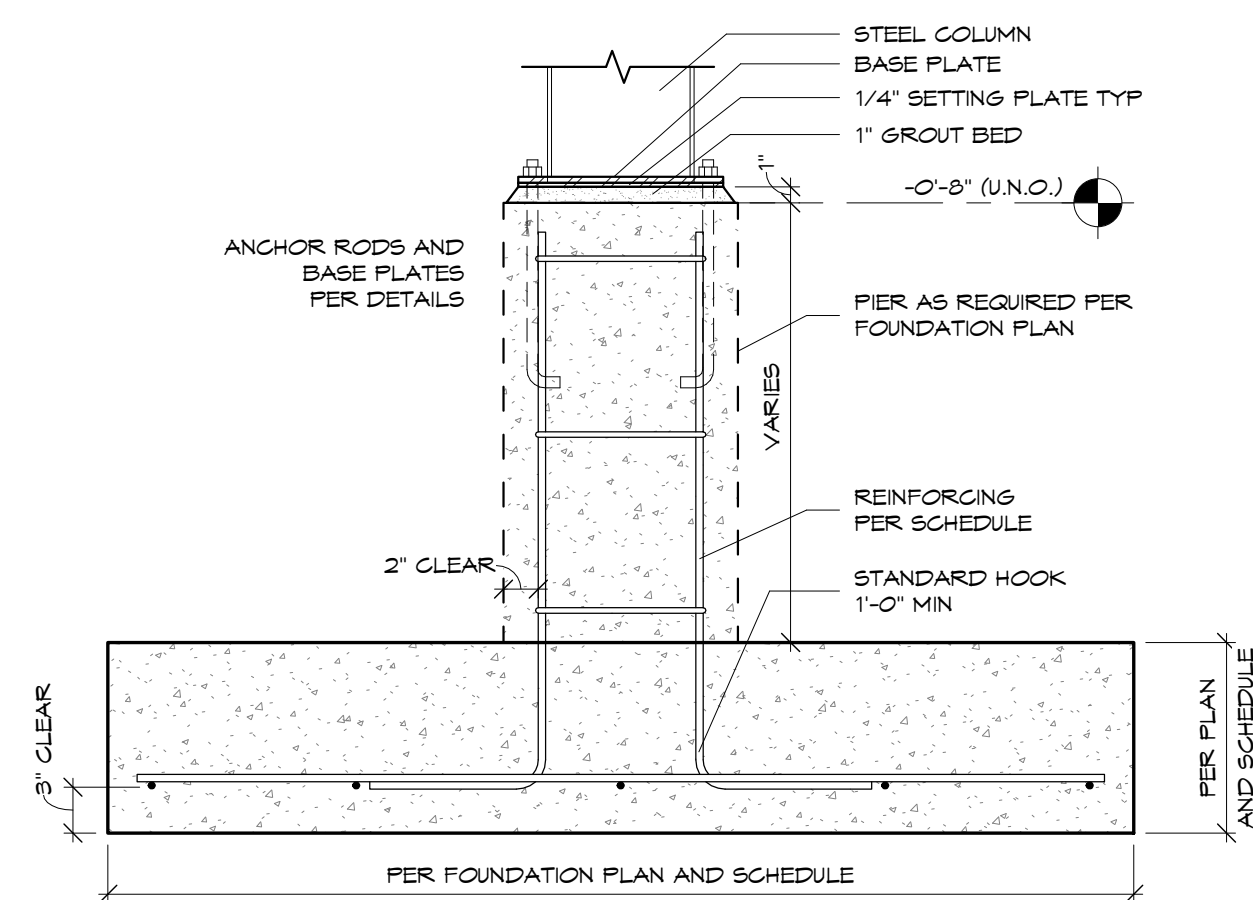

9 Pad Footing - Typ
1" = 1'-0"

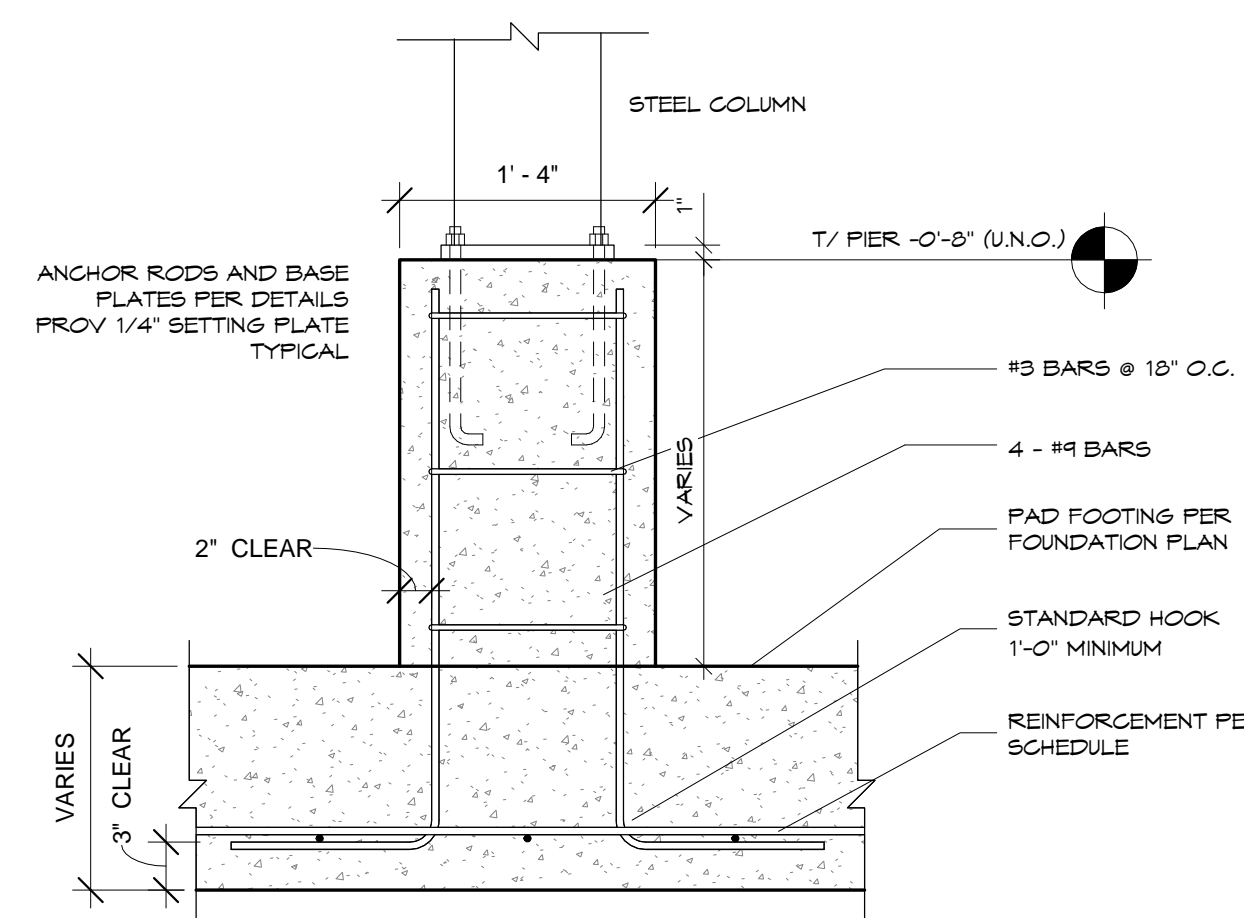

8 Pier - Typ
1" = 1'-0"

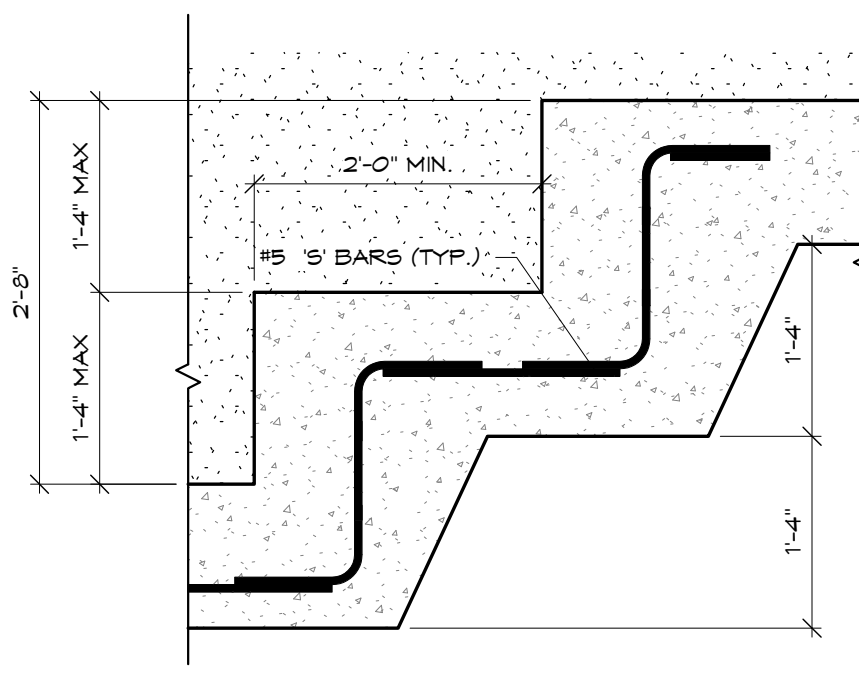

5 Footing Step - Typ.
3/4" = 1'-0"

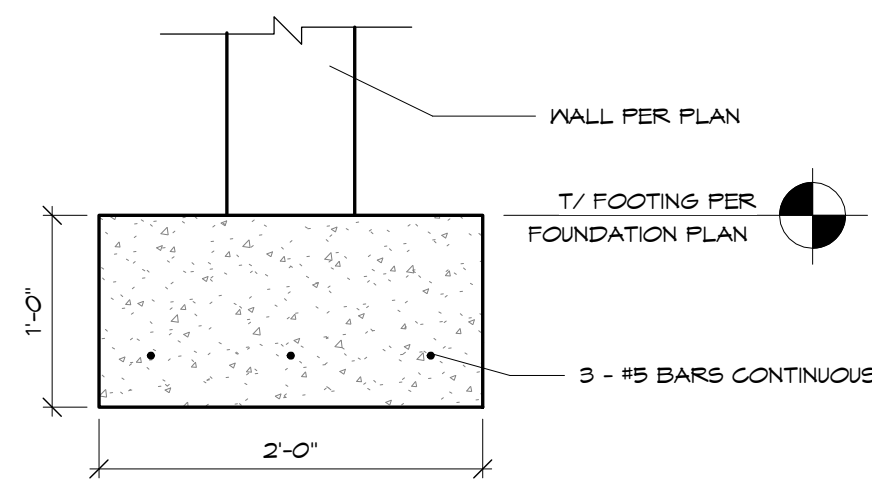

4 Strip Footing - Typ
1" = 1'-0"

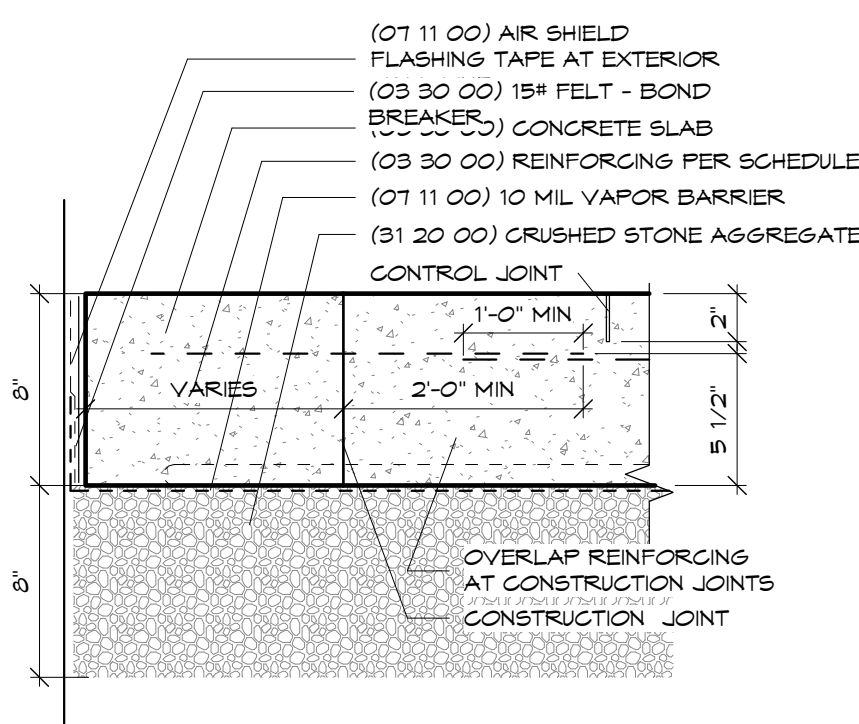

3 Concrete Slab - Type C
1 1/2" = 1'-0"

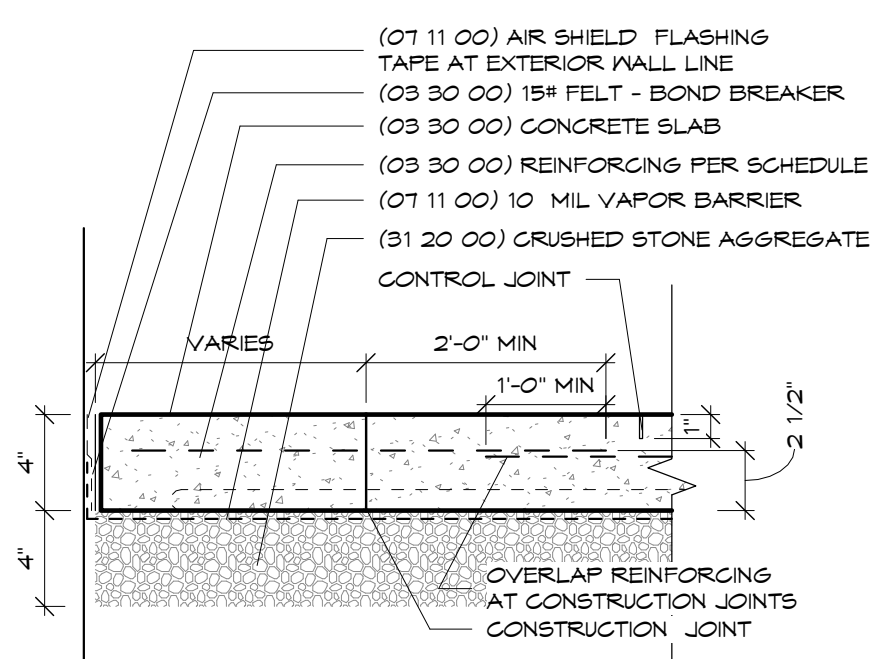

2 Concrete Slab - Type A
1 1/2" = 1'-0"

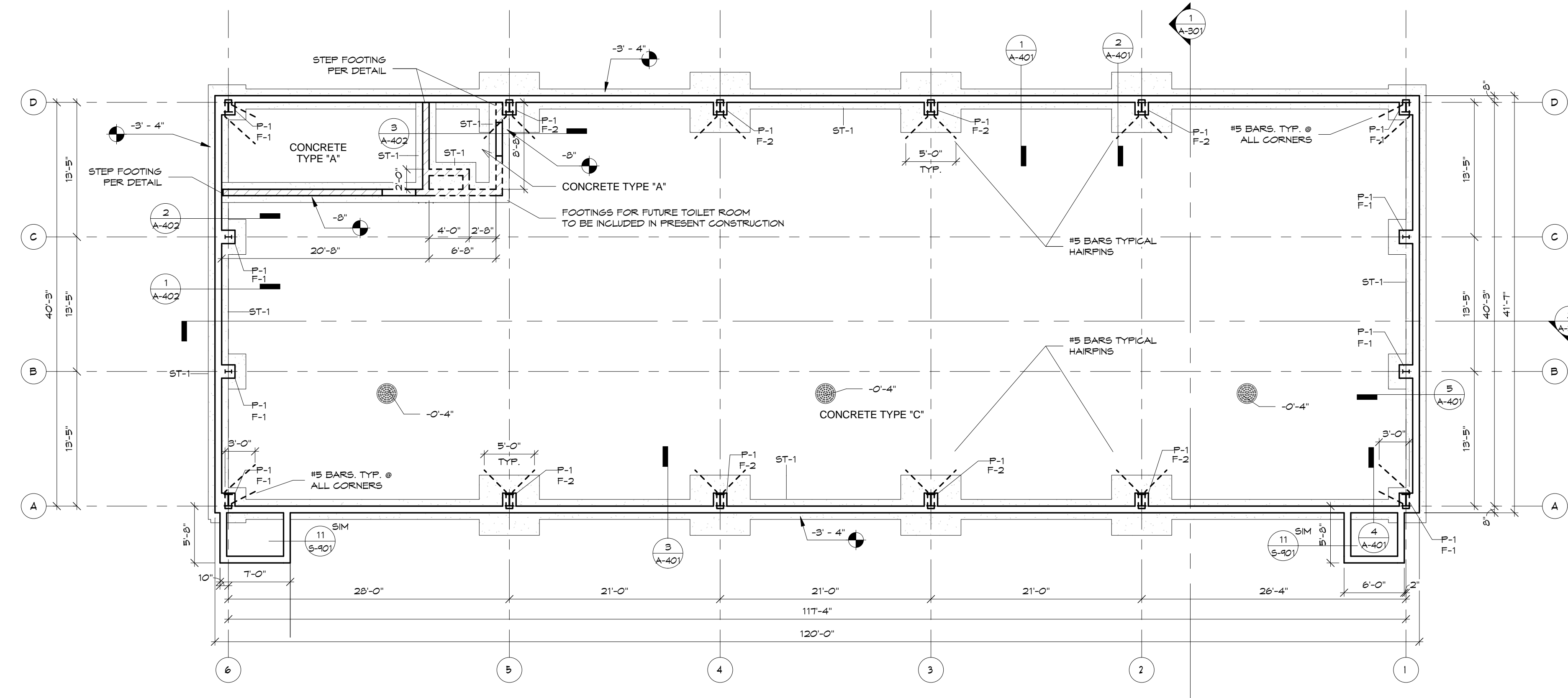

1 Foundation Plan
1/8" = 1'-0"

LOAD CHART	
LIVE LOAD	21 PSF
DEAD LOAD	12 PSF
METAL ROOFING	= 2.0
INSULATION	= 2.0
PURLINGS	= 3.0
MECHANICAL	= 2.0
MISCELLANEOUS	= 3.0
TOTAL	12.0
DESIGN LOAD	33 PSF

WIND LOAD	
BASIC WIND SPEED	= 90 MPH
IMPORTANCE FACTOR	= 1.0
OCCUPANCY CATEGORY	= II
EXPOSURE CATEGORY	= C
ENCLOSURE CLASSIFICATION	= Partially Enclosed

LINTEL SCHEDULE			
MARK	TYPE	PLATE SIZE	REINFORCING AND END BEARING
L-1	2L3-1/2X3-1/2X1/4	7" X 1/4"	8", GROUT SOLID THREE COURSES

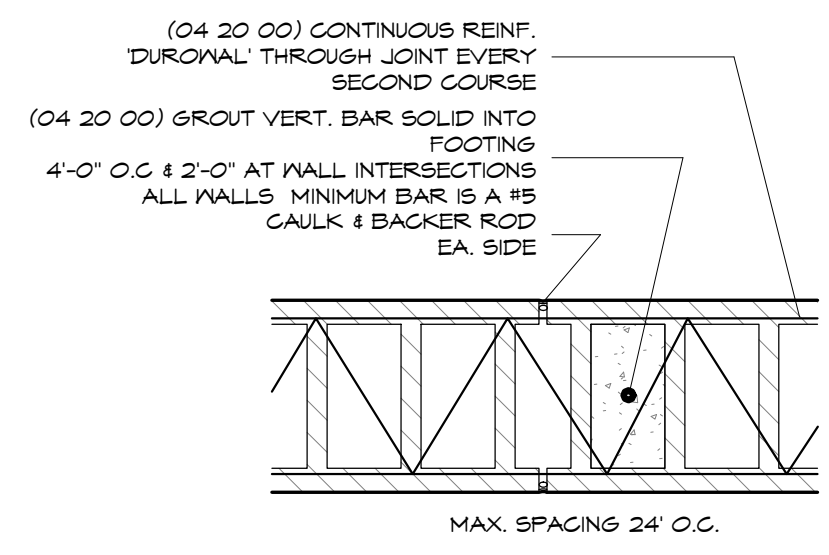

3 Masonry Control Joint
 1 1/2" = 1'-0"

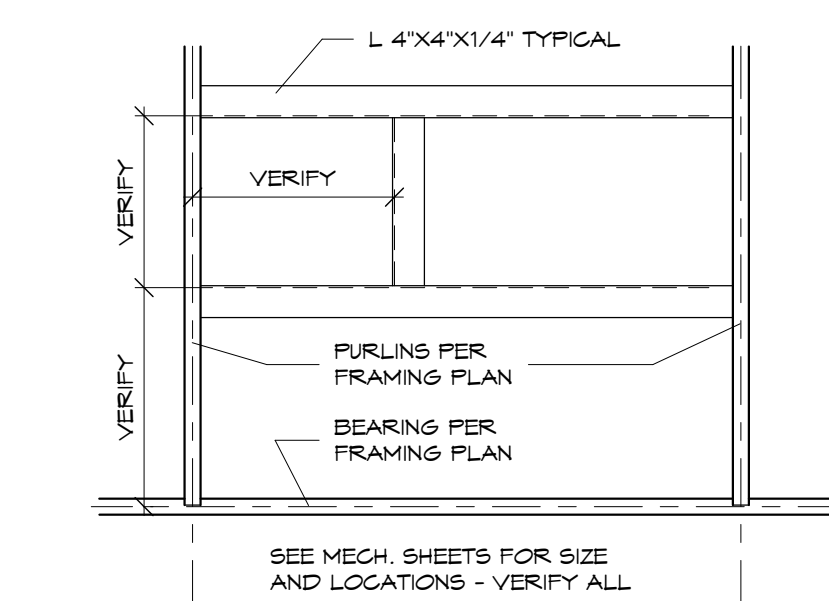

2 Framing at Roof Openings
 1/2" = 1'-0"

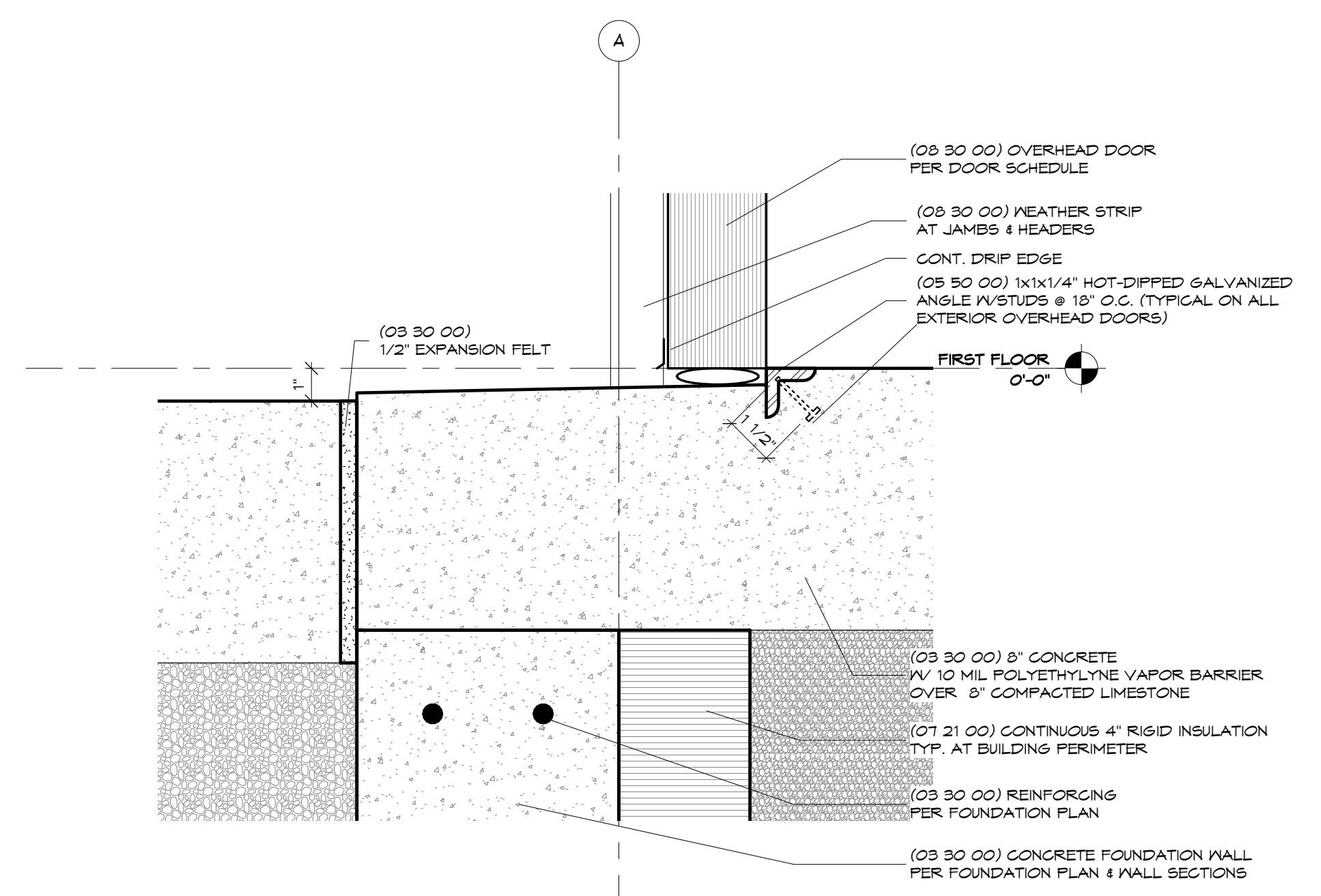

5 OH Door Threshold
 3" = 1'-0"

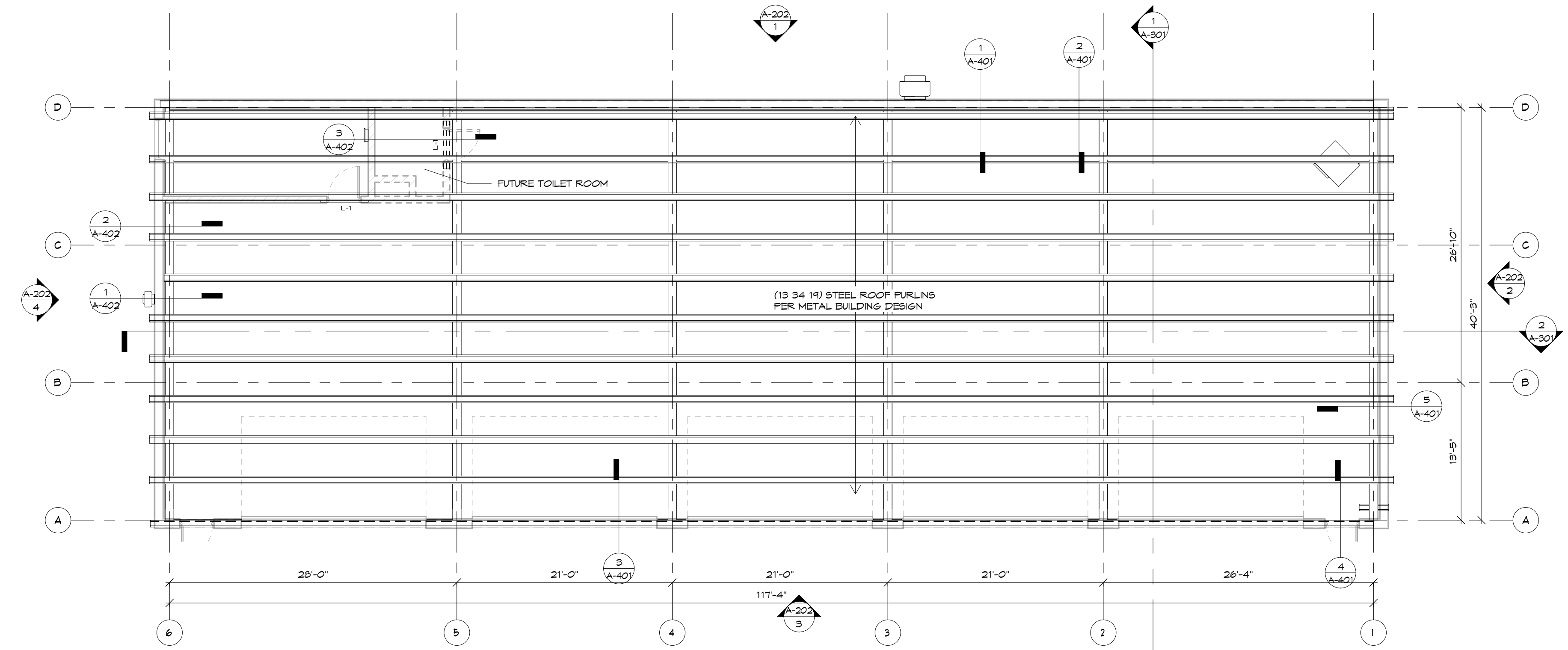

1 Roof Framing Plan
 1/8" = 1'-0"

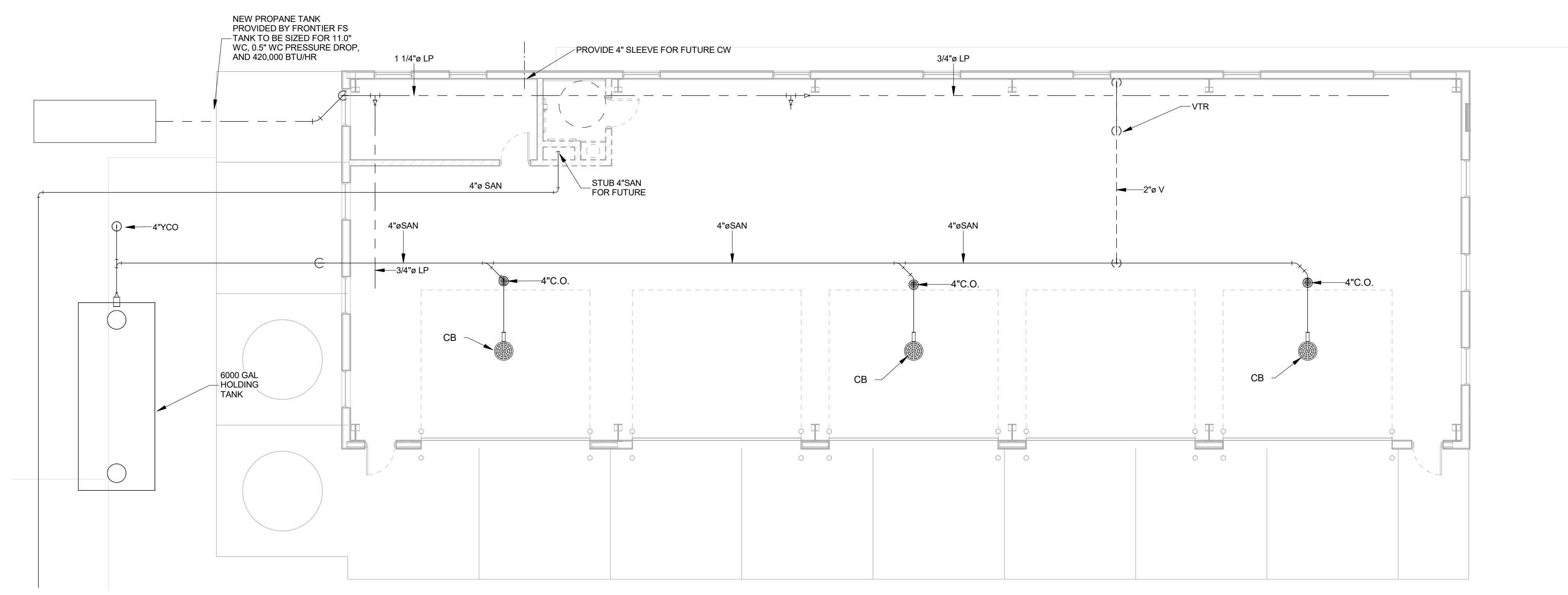

1 Satellite Building Plumbing Plan - Alt #1
 P-204 SCALE: 1/8" = 1'-0"

HVAC SYMBOLS AND ABBREVIATIONS

12X10	12" WIDE X 10" DEEP DUCT
12X10	12" ROUND DUCT
----	LINED DUCT
⊥	RECT ELBOW
⊥	RECT ELBOW WITH TURNING VANES
⊥	RECT ELBOW UP OR DOWN
⊙	THERMOSTAT
⊙	SENSOR
⊙	CO SENSOR
⊙	NO2 SENSOR
⊙	CO2 SENSOR
⊙	CONTROL PANEL
⊙	WALL SWITCH
⊙	SMOKE DETECTOR
⊙	TIMECLOCK
⊙	VOLUME DAMPER
⊙	MOTORIZED DAMPER
⊙	SUPPLY
⊙	RETURN
⊙	ROUND ELBOW
⊙	RECTANGULAR RADIUS ELBOW
⊙	FLEX DUCT
⊙	ROUND TAP
12X10AL	12X10 ALUMINUM DUCT
12X10SS	12X10 STAINLESS STEEL DUCT
12X10BI	12X10 BLACK IRON DUCT
⊙	CONNECTION TO EXISTING
HHWS	HEATING HOT WATER SUPPLY
HHWR	HEATING HOT WATER RETURN
(FSD)	FIRE SMOKE DAMPER
(FD)	FIRE DAMPER
(SD)	SMOKE DAMPER
(RD)	RADIATION DAMPER
(RVD)	REMOTE OPERATED VOLUME DAMPER
MOD	MOTOR OPERATED DAMPER
SA	SUPPLY AIR
RA	RETURN AIR
EA	EXHAUST AIR
RE	RELIEF AIR
OA	OUTSIDE AIR

SATELLITE BLDG HVAC GENERAL NOTES

- ALL DUCTWORK IS DIAGRAMMATIC AND COORDINATED TO THE BEST AVAILABLE INFORMATION. CONTRACTOR SHALL VERIFY STRUCTURE AND LOCATION OF OTHER TRADED PRIOR TO FABRICATION.
- LIMIT FLEX RUNS TO MAXIMUM OF 5'-0" AND ROUTE AS STRAIGHT AS POSSIBLE
- INSTALL ALL EQUIPMENT PER LOCAL AND STATE CODES AND PER MANUFACTURERS RECOMMENDATIONS
- SYSTEM SHALL BE BALANCED BY THE INSTALLING CONTRACTOR. BALANCE AIR FLOWS FOR GRILLES AND EQUIPMENT TO +/- 10% OF SCHEDULED AIRFLOWS. INCLUDE SYSTEM MANUFACTURER, MODEL, SERIAL, RPM, HORSEPOWER, VOLTAGE, AMPERAGE, ETC IN REPORTS. SUBMIT THE BALANCING REPORTS TO THE DESIGN PROFESSIONAL BEFORE A COMPLIANCE STATEMENT CAN BE SUBMITTED.
- GAS PIPING SHALL BE SCHEDULE 40 BLACK IRON. PIPE 2" AND SMALLER SHALL HAVE THREADED PIPE CONNECTIONS AND FITTINGS. PIPE 2-1/2" AND LARGER SHALL HAVE WELDED CONNECTIONS AND FITTINGS. PROVIDE GAS REGULATORS AS NECESSARY.
- OUTSIDE AIR INTAKES SHALL BE MINIMUM OF 10'-0" FROM ANY BUILDING EXHAUST, FLUES, PLUMBING VENTS AND LOT LINE.
- LOW VOLTAGE WIRING SHALL BE BY HVAC CONTRACTOR
- COORDINATE DIFFUSER LAYOUT WITH LIGHTING LAYOUT
- CONTRACTORS NEED PRIOR APPROVAL FOR QUOTING ALTERNATIVE EQUIPMENT. ALTERNATIVE EQUIPMENT MAY REQUIRE OPTIONAL ACCESSORIES TO MATCH BASE BID EQUIPMENT. CONTRACTORS ARE RESPONSIBLE FOR FURNISHING ALL SUCH ITEMS.
- ROOMS WITHOUT RETURN AIR GRILLES OR TRANSFER GRILLES, SHALL HAVE DOORS UNDER CUT 1" BY GENERAL CONTRACTOR FOR RETURN AIR
- DUCT SIZES LISTED ON PLANS ARE THE REQUIRED CLEAR INSIDE DIMENSION.
- THE CONTRACTOR SHALL PROVIDE THE OWNER WITH WRITTEN INSTRUCTIONS FOR THE OPERATION AND MAINTENANCE OF THE SYSTEM AND EQUIPMENT
- THERMOSTAT LOCATIONS SHALL BE REVIEWED BY OWNER, TENANT & CONTRACTOR BEFORE INSTALLATION. CONTROLS SHALL BE LOCATED 48" ABOVE FINISHED FLOOR
- UNITS SHALL BE SUSPENDED WITH NON-COMBUSTIBLE HANGERS

SATELLITE BLDG CONTROLS

- UH-1.2.3.4
PROVIDE A SEVEN DAY PROGRAMMABLE THERMOSTAT WITH OCCUPIED/UNOCCUPIED CYCLES.
OCCUPIED - HEATING SHALL MAINTAIN OCCUPIED SETPOINT
- FAN SHALL CYCLE ON/OFF TO PROVIDE HEATING.
- PRV-1
FAN TO RUN CONTINUOUSLY
- PRV-2.3
FAN OPERATED ON ALARM CONDITION OF CO2 SENSOR. CONTROL DAMPERS ON LOUVER SHALL ALSO OPEN ON ALARM CONDITIONS

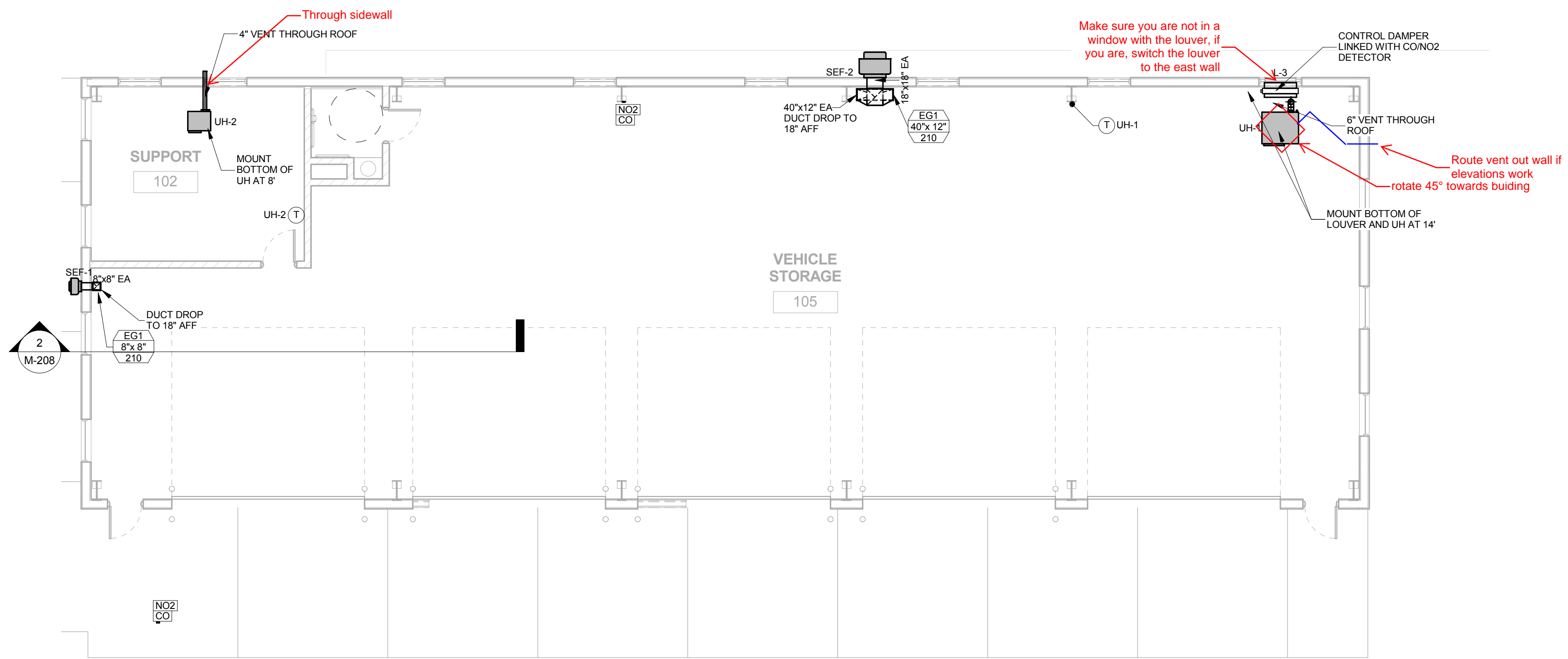

1 Satellite Building HVAC Plan - Alt #1
SCALE: 1/8" = 1'-0"

SATELLITE BLDG SIDEWALL EXHAUST FAN SCHEDULE

TAG	SERVES	Config Total Air Flow	TSP	HP	MOTOR BHP	RPM	V	PH	HZ	MODEL	MFG	WEIGHT	NOTES
SEF-1	OCCUPIED EXHAUST	210 CFM	0.25 in-wg	0.10 hp	0.02 hp	1725	115 V	1	60 Hz	CW-070-VG	Greenheck	31.00 lb	1,2
SEF-2	ALARM EXHAUST	3150 CFM	0.25 in-wg	0.50 hp	0.41 hp	1725	115 V	1	60 Hz	CWB-200-5	Greenheck	110.20 lb	1,2

- PROVIDE DISCONNECT AND GRAVITY BACKDRAFT DAMPERS
- GREENHECK, COOK, OR PENN

SATELLITE BLDG UNIT HEATER SCHEDULE

TAG	SPACE	AIRFLOW	TYPE	BTU IN	BTU OUT	FAN HP	V	φ	HZ	AMPS	MOCP	MODEL	MFG	WEIGHT	NOTES
UH-1	MEZZANINE	3843 CFM	GAS	300000 Btu	249000 Btu	0.5 hp	115 V	1	60 Hz	11 A	20 A	UDAP 300	REZNR	270.00 lb	1,2,3
UH-2	102 SUPPORT	961 CFM	PROPANE	45000 Btu	37350 Btu	0.1 hp	115 V	1	60 Hz	2 A	15 A	UDAP 45	REZNR	60.00 lb	1,2

- MODINE, REZNR, STERLING, OR TRANE
- PROVIDE PROPANE CONVERSION KIT
- PROVIDE STAINLESS STEEL HEAT EXCHANGERS

SATELLITE BLDG LOUVER SCHEDULE

TAG	AIRFLOW	VELOCITY	PRESSURE DROP	HEIGHT	LENGTH	WIDTH	Model	MFG	NOTES
L-3	1875 CFM	440 FPM	0.03 in-wg	3' - 0"	3' - 0"	0' - 6"	ESD-603	Greenheck	1

- ARCHITECT TO SELECT COLOR

SATELLITE BLDG GRILLES REGISTERS AND DIFFUSERS SCHEDULE

TAG	TYPE	MOUNT	AIR FLOW CFM	NECK SIZE	FACE SIZE	MODEL	MFG	NOTES
EG1	Exhaust Air	DUCT	AS SHOWN			EXPANDED METAL		

SATELLITE BLDG MECH EQ STARTERS & DISCONNECTS

TAG	SERVES	DISCONNECTS				STARTERS				NOTES
		FURNISHED BY	INSTALLED BY	LOCATION	TYPE	FURNISHED BY	INSTALLED BY	LOCATION	TYPE	
SEF-1	OCCUPIED EXHAUST	HVAC	HVAC	PRE-WIRED	NEMA 1	ELECTRICAL	ELECTRICAL	SEE E-PLANS	STARTER W/24V RELAY	
SEF-2	ALARM EXHAUST	HVAC	HVAC	PRE-WIRED	NEMA 1	ELECTRICAL	ELECTRICAL	SEE E-PLANS	STARTER W/24V RELAY	
UH-1	101 VEHICLE STORAGE ALARM	ELECTRICAL	ELECTRICAL	NEAR UNIT	NEMA 1	HVAC	HVAC	PRE-WIRED	CONTROL BOARD	
UH-2	102 SUPPORT	ELECTRICAL	ELECTRICAL	NEAR UNIT	NEMA 1	HVAC	HVAC	PRE-WIRED	CONTROL BOARD	

SATELLITE BLDG DUCT CONSTRUCTION SCHEDULE

SYSTEM TYPE	SYSTEM LOCATION	MATERIAL	SMACNA PRESSURE CLASS	SMACNA SEAL CLASS	INSULATION TYPE	R-VALUE	INSULATION THICKNESS	NOTES
EXHAUST	ALL	GLAVANIZED	2"	B	NONE			

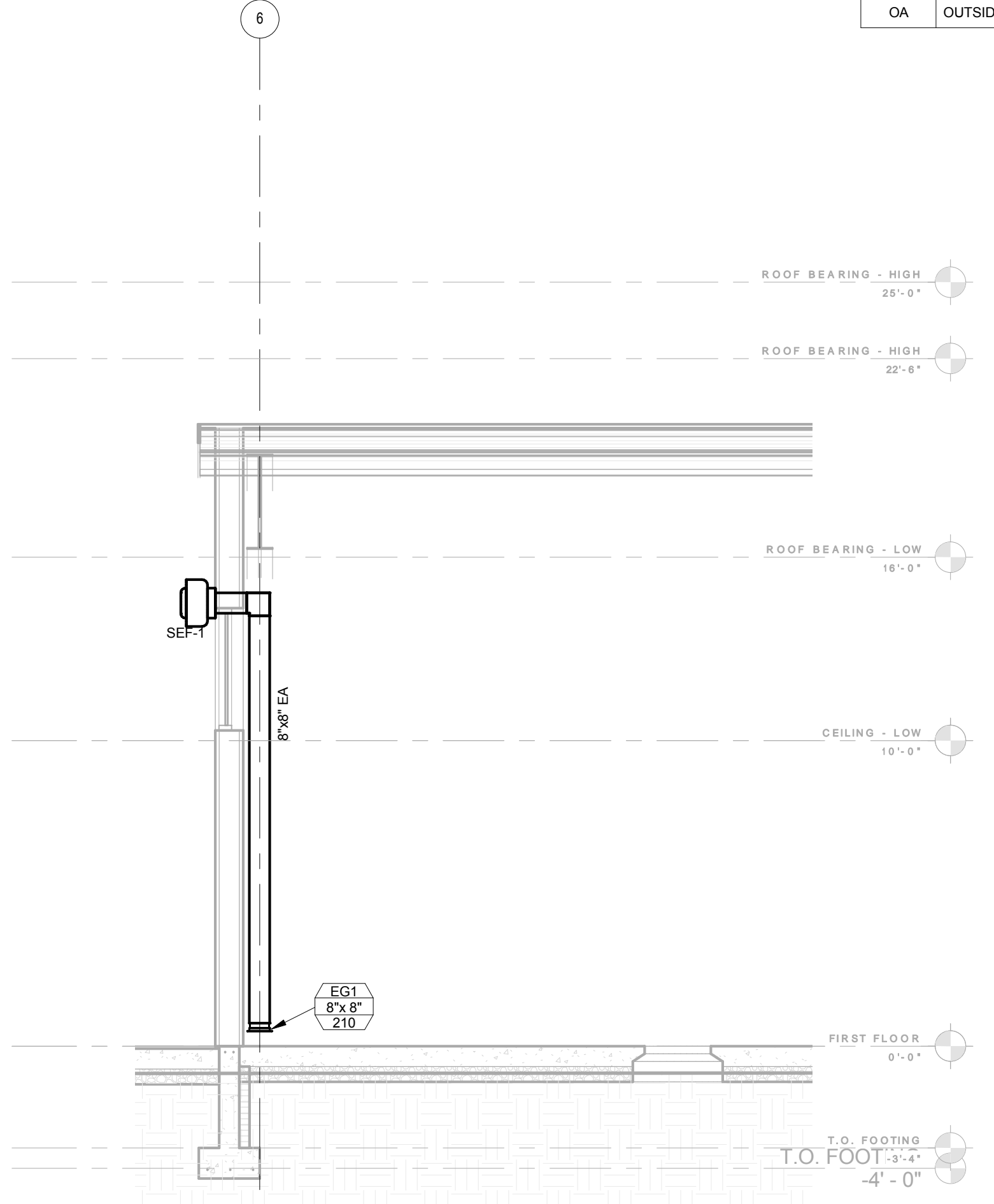

2 EXHAUST FAN SECTION
SCALE: 1/4" = 1'-0"

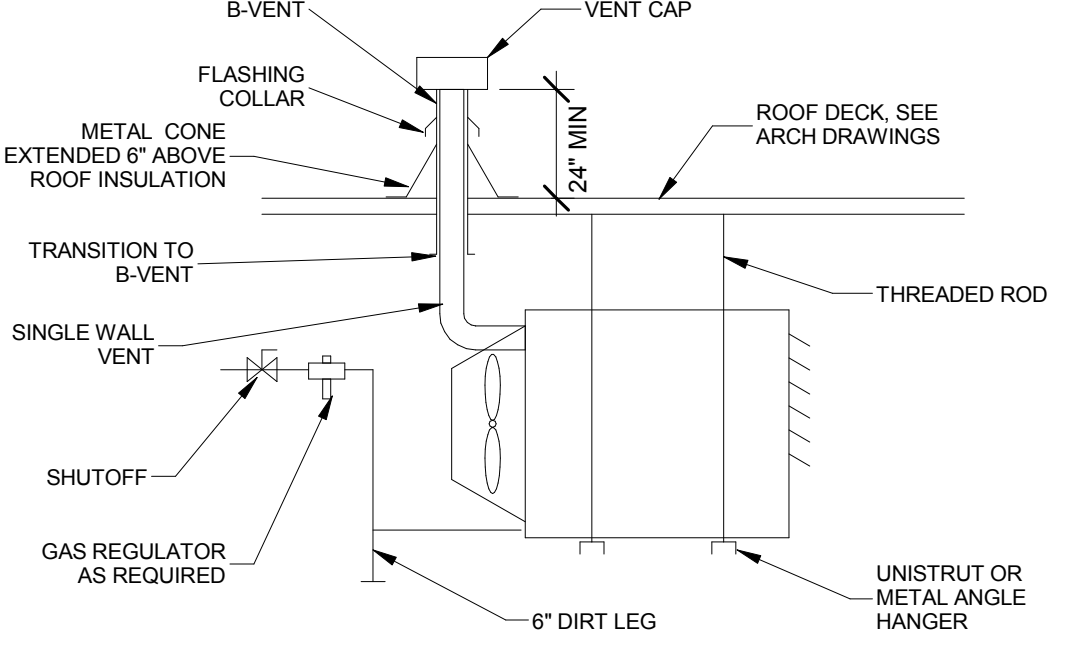

3 UNIT HEATER DETAIL
SCALE: NO SCALE

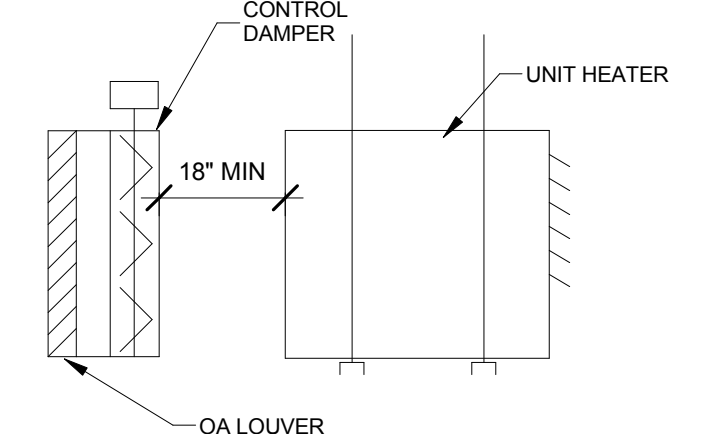

4 MAKE UP AIR LOUVER W/ UNIT HEATER DETAIL
SCALE: NO SCALE

Mechanical Plan and Schedules

kuenyarch.com ©2014 Kueny Architects L.L.C. - All Rights Reserved
Dane County - Highway Facility Satellite Building
US 151 and County Highway V
01/12/15



LIGHTING NOTES

- 1 CHG VEHICLES MAY BE STORED IN THE VEHICLE STORAGE AREAS IN THE FUTURE. KEEP ALL WIRING BELOW THE CEILING CLASSIFIED SPACE PER DETAIL 2 ON SHEET E-508. ANY ELECTRICAL WORK IN THE CEILING CLASSIFIED SPACE SHALL BE CLASS 1, DIVISION 2. HANG HORIZONTAL STRUT FROM THREADED ROD TO MOUNT CONDUIT AND BOXES BELOW CLASSIFIED CEILING SPACE AREA.
- 2 MOUNT TYPE X4 EMERGENCY/EXIT LIGHTS WITH CENTER OF EMERGENCY LIGHTS 8' AFF.
- 3 MOUNT TYPE EMR LIGHT FIXTURE 8'6" AFG.
- 4 ASTRONOMICAL TIME CLOCK FOR EXTERIOR LIGHTING SHALL BE AN INTERMATIC ET8015C WITH BATTERY BACK UP OR EQUAL. SET ASTRONOMICAL CLOCK FOR DUSK TO DAWN OPERATION.
- 5 TYPICAL: CENTER TYPE OE LIGHTS APPROXIMATELY 20'1-1/2" AFF TO CENTER THE LIGHTS IN THE SPACE ABOVE THE OVERHEAD DOORS.
- 6 GENERAL NOTE: SET ROOM 303 OCCUPANCY SENSOR TIME DELAY TO 5 MINUTES.
- 7 GENERAL NOTE: SET ROOM 301 AND 302 LIGHT FIXTURE OCCUPANCY SENSOR TIME DELAY TO 10 MINUTES.
- 8 CENTER TYPE OE LIGHT APPROXIMATELY 15'2" AFF TO CENTER THE LIGHTS IN THE SPACE BETWEEN THE TOP OF THE WINDOW AND THE BOTTOM OF THE INSIDE STEEL.
- 9 PROVIDE LITHONIA SYNERGY ISD-BC, 0-10VDC DIMMER OR EQUAL COMPATIBLE WITH LED DRIVER.
- 10 HANG TYPE W LIGHTS APPROXIMATELY 16' 6" AFF WITH AIRCRAFT CABLE. PROVIDE RECEPTACLE AND CORD WITH PLUG AS REQUIRED. PROVIDE STRUT ACROSS BOTTOM OF BEAM OR PURLINS TO HANG LIGHTS FROM AS REQUIRED. ON LIGHTS THAT ARE NOT UNDER A BEAM, HANG LIGHTS FROM CONDUIT STRUT OR PROVIDE STRUT ACROSS PURLINS TO HANG LIGHTS FROM AS REQUIRED. KEEP CONDUIT AND BOXES BELOW CLASSIFIED CEILING SPACE PER DETAIL 2 ON SHEET E-508.
- 11 HANG TYPE Y LIGHTS APPROXIMATELY 14' 6" AFF WITH AIRCRAFT CABLE. PROVIDE RECEPTACLE AND CORD WITH PLUG AS REQUIRED. PROVIDE STRUT ACROSS BOTTOM OF BEAM OR PURLINS TO HANG LIGHTS FROM AS REQUIRED. ON LIGHTS THAT ARE NOT UNDER A BEAM, HANG LIGHTS FROM CONDUIT STRUT OR PROVIDE STRUT ACROSS PURLINS TO HANG LIGHTS FROM AS REQUIRED. KEEP CONDUIT AND BOXES BELOW CLASSIFIED CEILING SPACE PER DETAIL 2 ON SHEET E-508.
- 12 HANG TYPE Y LIGHTS APPROXIMATELY 12' 6" AFF WITH AIRCRAFT CABLE. PROVIDE RECEPTACLE AND CORD WITH PLUG AS REQUIRED. PROVIDE STRUT ACROSS BOTTOM OF BEAM OR PURLINS TO HANG LIGHTS FROM AS REQUIRED. ON LIGHTS THAT ARE NOT UNDER A BEAM, HANG LIGHTS FROM CONDUIT STRUT OR PROVIDE STRUT ACROSS PURLINS TO HANG LIGHTS FROM AS REQUIRED. KEEP CONDUIT AND BOXES BELOW CLASSIFIED CEILING SPACE PER DETAIL 2 ON SHEET E-508.
- 13 MOUNT TYPE EM1 EMERGENCY LIGHTS 10' AFF. PROVIDE BRACKET OR UNISTRUT TO MOUNT TYPE EM1 LIGHTS VERTICALLY ON ANGLED BEAM.
- 14 MOUNT TYPE EM1 EMERGENCY LIGHTS 9' AFF.
- 15 RUN RIGID CONDUIT OUT OF LIGHT INTO A SEAL OFF. FROM SEAL OFF ENTER THE BUILDING AND RUN RIGID CONDUIT DOWN INTO UNCLASSIFIED AREA AND PROVIDE ANOTHER SEAL OFF. SEE DETAIL 2 ON SHEET E-508 FOR CEILING CLASSIFIED SPACE.

GENERAL SHEET NOTES

1. INFORMATIONAL BID A: ADD OR DEDUCT FOR ONLY SQUARE D DISTRIBUTION EQUIPMENT. ELECTRICAL CONTRACTOR TO USE CUTLER-HAMMER, GE, SIEMENS OR SQUARE D IN BASE BID.
2. SEE ARCHITECTURAL PLANS FOR SITE PLAN.
3. CONDUIT MAY BE EXPOSED AT PANEL AND AT CEILING. RECESS CONDUIT AND MC CABLE BEHIND INTERIOR METAL WALL SKIN AND INSIDE BLOCK WALLS.

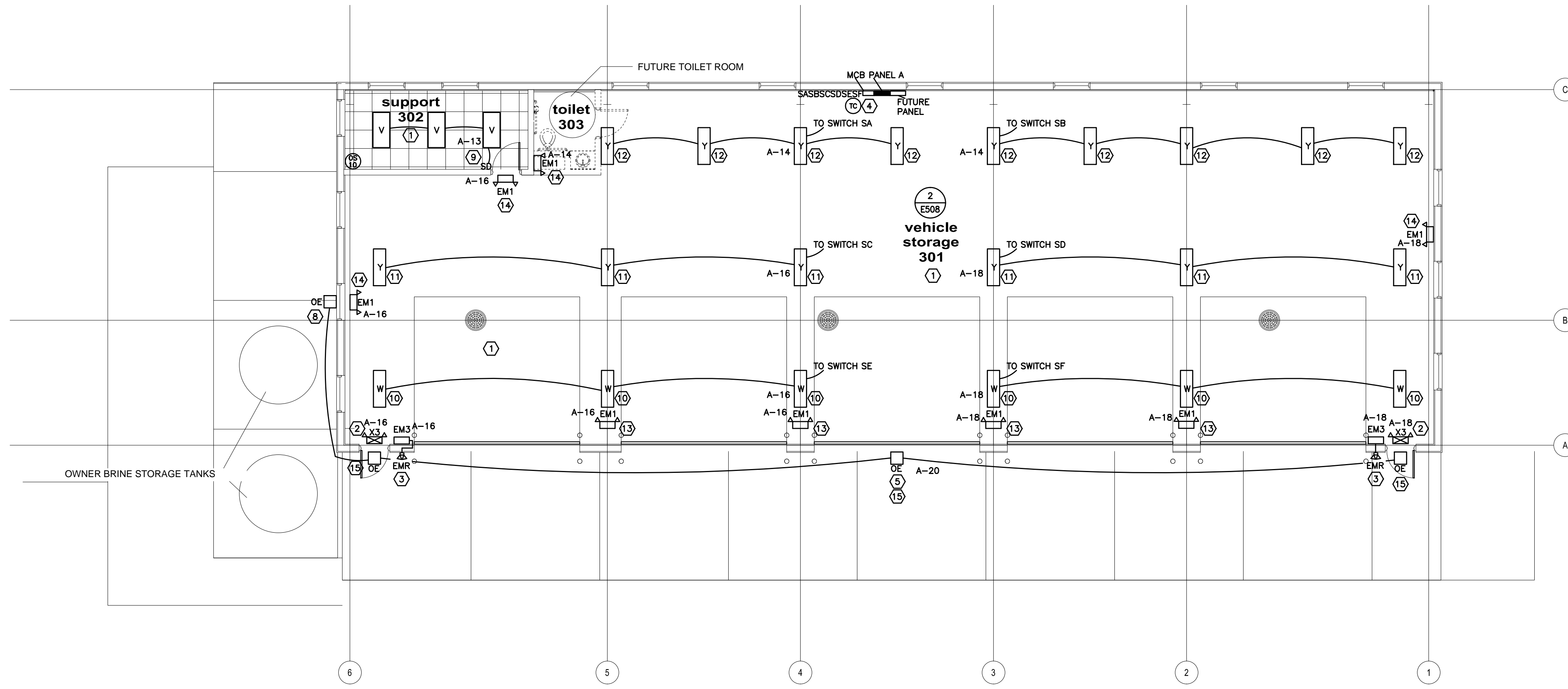

1 Satellite Building Lighting Plan
1/8" = 1'-0"



- 1 CHG VEHICLES MAY BE STORED IN THE VEHICLE STORAGE AREAS IN THE FUTURE. KEEP ALL WIRING BELOW THE CEILING CLASSIFIED SPACE PER DETAIL 2 ON SHEET E-508. ANY ELECTRICAL WORK IN THE CEILING CLASSIFIED SPACE SHALL BE CLASS 1, DIVISION 2. HANG HORIZONTAL STRUT FROM THREADED ROD TO MOUNT CONDUIT AND BOXES BELOW CLASSIFIED CEILING SPACE AREA.
- 2 DISCONNECT PROVIDED ON EQUIPMENT BY HVAC CONTRACTOR.
- 3 SEF-1 RUNS CONTINUOUSLY.
- 4 TYPICAL: PROVIDE 120V POWER TO TRANSFORMERS, FUSES, FUSE HOLDERS, SWITCH AS DISCONNECT ON TRANSFORMER PRIMARY BEFORE FUSE. CONDUIT AND BOXES AS REQUIRED AT ALL CO/NO2 LOCATIONS. PROVIDE BUSSMANN HEB SERIES IN-LINE FUSE HOLDERS IN A BOX NEXT TO THE TRANSFORMER WITH BUSSMANN FNQ FUSES SIZED PER CODE FOR PRIMARY AND SECONDARY OF TRANSFORMER. LOW VOLTAGE TRANSFORMERS, CO SENSOR, NO2 SENSOR AND LOW VOLTAGE WIRING BY HVAC CONTRACTOR. CO SENSOR LOCATED APPROXIMATELY 3' TO 5' AFF. NO2 SENSOR LOCATED WITHIN 3' TO 5' OF CEILING OR ROOF DECK. VERIFY ALL LOCATIONS. IF NO2 SENSOR IS LOCATED IN THE CLASSIFIED CEILING SPACE, RIGID CONDUIT AND SEAL OFFS WILL BE REQUIRED. TRANSFORMER AND FUSES TO BE MOUNTED BELOW THE CLASSIFIED CEILING SPACE.
- 5 PROVIDE #4 MINIMUM FROM MAIN CIRCUIT BREAKER MCB TO GROUND RODS, REBAR AND BUILDING STEEL WITH EXOTHERMIC CONNECTION TO CODE. NO METAL WATER PIPE IS RUN TO THE BUILDING.
- 6 COORDINATE ELECTRICAL SERVICE WITH ADAMS-COLUMBIA ELECTRIC COOPERATIVE. ADAMS-COLUMBIA ELECTRIC COOPERATIVE TO PROVIDE UNDERGROUND SERVICE LATERAL TO METER PEDESTAL. PROVIDE 3/3" IN A 2" CONDUIT FROM METER PEDESTAL TO PANEL A.
- 7 LEAVE SPACE FOR FUTURE PANEL.
- 8 PROVIDE SQUARE D JDL 200A STANDARD INTERRUPTING (25 KAIR MINIMUM), 1 CYCLE MAXIMUM CLEARING TIME. MAIN CIRCUIT BREAKER IN A SQUARE D NEMA 1 SURFACE MOUNT ENCLOSURE WITH NEUTRAL ASSEMBLY AND GROUND SERVICE KIT.
- 9 PROVIDE FEEDER (3/3", #6 GND, 2") FROM MAIN CIRCUIT BREAKER MCB TO PANEL A.
- 10 PROVIDE BRADY 121097 ARC FLASH WARNING LABELS ON MAIN CIRCUIT BREAKER AND PANEL A. INCLUDE FLASH PROTECTION BOUNDARY OF 19 INCHES, EQUIPMENT ID AND DATE.
- 11 MOUNT GARAGE OVERHEAD DOOR MOTOR IS IN CLASSIFIED CEILING SPACE AREA. CLASS 1 DIV 2 WIRING IS REQUIRED IN CLASSIFIED AREA.

PANEL A

NO.	DESCRIPTION	BKR	KW	PHASE	KW	BKR	DESCRIPTION	NO.
1	WEST VEHICLE STORAGE 301 OHD	15/2	1.92	A	1.92	15/2	EAST VEHICLE STORAGE 301 OHD	2
3				B				4
5	WEST VEHICLE STORAGE 301 OHD	15/2	1.92	A	1.92	15/2	EAST VEHICLE STORAGE 301 OHD	6
7				B				8
9	CENTER VEHICLE STORAGE 301 OHD	15/2	1.92	A	3.00	20/2	SUPPORT 302 EWH-1	10
11				B				12
13	SUPPORT 302 LIGHTS	20/1	.13	A	1.17	20/1	N VEHICLE STORAGE 301 LIGHTS	14
15	SPARE	20/1	-	B	.88	20/1	SW VEHICLE STORAGE 301 LIGHTS	16
17	SPARE	20/1	-	A	.84	20/1	SE VEHICLE STORAGE 301 LIGHTS	18
19	SUPPORT 302 RECEPTACLES	20/1	.72	B	.18	20/1	EXTERIOR LIGHTS, TIME CLOCK	20
21	W VEHICLE STORAGE 301 RECEP	20/1	.18	A	.36	15/1	VEHICLE STORAGE 301 CO/NO2 SENSORS	22
23	W, S VEHICLE STORAGE 301 RECEP	20/1	.36	B	.18	20/1	WEST CENTER EXTERIOR RECEPTACLE	24
25	SOUTH EXTERIOR WALL WEST RECEP	20/1	.18	A	.36	20/1	WEST VEHICLE STORAGE 301 RECEP	26
27	SOUTH EXTERIOR WALL WEST RECEP	20/1	.18	B	.18	20/1	WEST EXTERIOR WALL SOUTH RECEP	28
29	SOUTH EXTERIOR WALL EAST RECEP	20/1	.18	A	.24	15/1	VEHICLE STORAGE 301 SEF-1	30
31	SOUTH EXTERIOR WALL EAST RECEP	20/1	.18	B	.36	20/1	NW VEHICLE STORAGE 301 RECEP	32
33	EAST EXTERIOR WALL SOUTH RECEP	20/1	.18	A	1.18	20/1	VEHICLE STORAGE 301 SEF-2	34
35	NE, E VEHICLE STORAGE 301 RECEP	20/1	.54	B	-	20/1	SPARE	36
37	NE VEHICLE STORAGE 301 UH-1	20/1	1.32	A	-	20/1	SPARE	38
39	SPARE	20/1	-	B	-	20/1	SPARE	40
41	SPARE	20/1	-	A	-	20/1	SPARE	42

BRANCH CIRCUIT BREAKERS 10 KAIR MINIMUM
INCLUDE FEED THRU LUGS

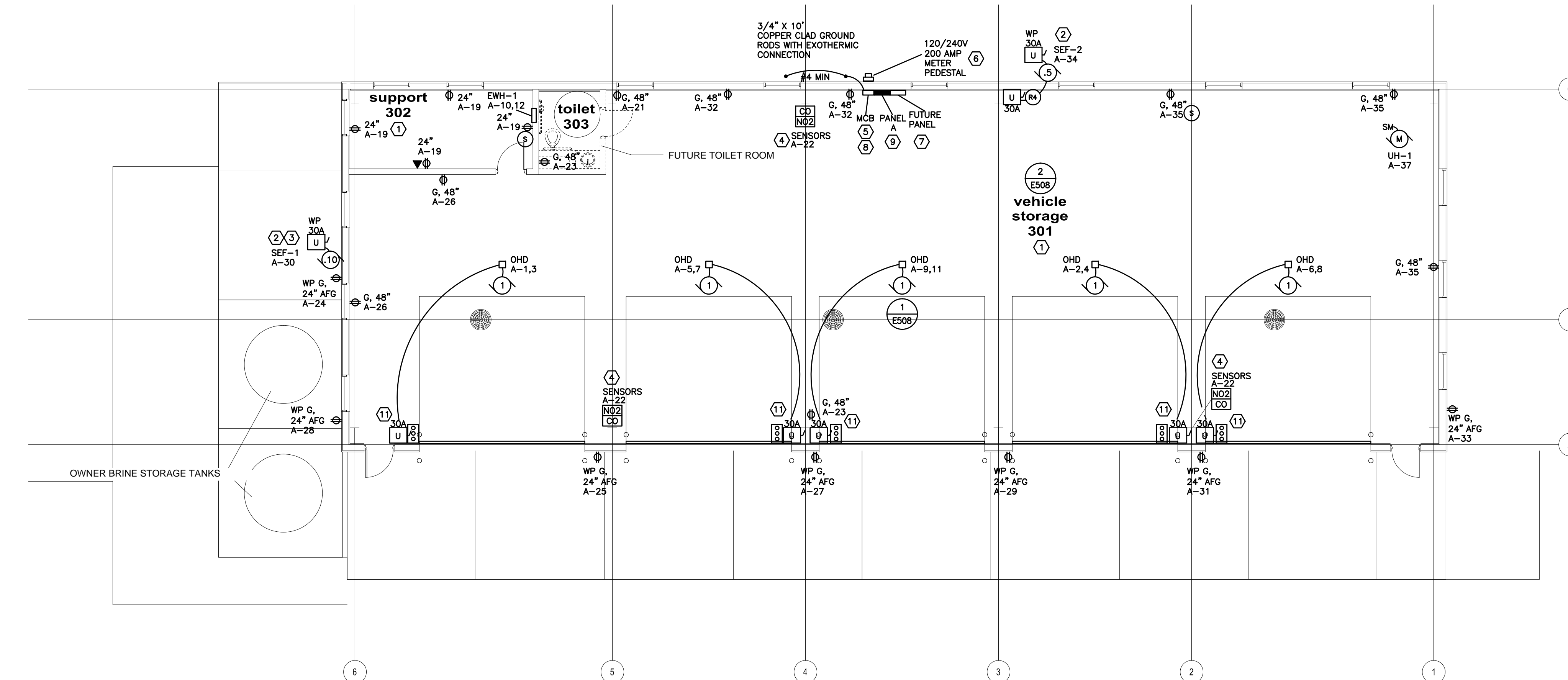

2 Satellite Building Power and Systems Plan
1/8" = 1'-0"



SYSTEMS

VOICE/DATA: WALL, FLOOR EC TO INSTALL 3/4" CONDUIT STUBBED ABOVE WALL OR OTHER ACCESSIBLE AREA. EXTEND CONDUIT UP TO JOISTS IN HIGH BAY AREAS. 4" SQUARE STEEL BOX WITH 1 GANG PLASTER RING UNLESS NOTED OTHERWISE. ELECTRICAL CONTRACTOR TO USE CONDUIT AT SURFACE MOUNT LOCATIONS (SHOP AREAS, MECHANICAL ROOMS, VEHICLE AREAS). ELECTRICAL CONTRACTOR MAY USE 3/4" ENT (IF ALLOWED BY CODE) WHERE CONCEALED IN WALLS AND STUBBED ABOVE CEILING GRID (OFFICE AREAS). SYSTEMS CONTRACTOR TO PULL CABLE, TERMINATE AND PROVIDE JACKS AND COVER PLATES. SEE ELECTRICAL DRAWINGS FOR VOICE/DATA LOCATIONS. MOUNT 18" AFF UNLESS NOTED OTHERWISE. "W" INDICATES WALL PHONE AT 54". VERIFY MOUNTING HEIGHT WITH SYSTEMS CONTRACTOR.

- S SINGLE POLE SWITCH—TOP OF BOX 48" AFF
- S2 TWO POLE SWITCH—TOP OF BOX 48" AFF
- S3 THREE WAY SWITCH—TOP OF BOX 48" AFF
- SD DIMMER SWITCH—TOP OF BOX 48" AFF
- SL LIGHTED SWITCH — LIGHT ON W/LOAD—TOP 48" AFF
- SL3 LIGHTED THREE WAY SWITCH — LIGHT ON W/LOAD TOP OF BOX 48" AFF
- ST COMMERCIAL 30 MINUTE ELECTRONIC TIMER SWITCH INTERMATIC E2035 SERIES OR EQUAL
- SWT COMMERCIAL 2 HOUR SPRING WOUND TIMER SWITCH INTERMATIC FD2H SERIES OR EQUAL
- Ø DUPLEX RECEPTACLE OFFICE NEMA 5-15R, 18" AFF UNLESS NOTED OTHERWISE ALL OTHER AREAS NEMA 5-20R, TOP OF BOX 48" AFF SHOP
- C COUNTER MOUNT 6" ABOVE COUNTER BACKSPASH
- B BELOW COUNTER
- G GFCI
- WP G WEATHERPROOF GFCI WITH CAST ALUMINUM IN-USE COVER
- TV 1' BELOW CEILING
- ⊕ FLOOR DUPLEX RECEPTACLE NEMA 5-15R
- ⊕ 208V 1 PHASE RECEPTACLE 18" AFF OFFICE, TOP OF BOX 48" AFF SHOP
- ⊕ TWO DUPLEX RECEPTACLES NEMA 5-20R TOP OF BOX 48" AFF—SHOP, VENDING
- ⊕ CORD DROP RECEPTACLE. PROVIDE SO CORD, GRIP, STRAIN RELIEF, BOX AND RECEPTACLE.
- ⊕ QUAD CORD DROP RECEPTACLE. PROVIDE SO CORD, GRIP, STRAIN RELIEF, BOX AND RECEPTACLE.
- SM MANUAL MOTOR SWITCH PADLOCKABLE IN THE OFF POSITION
- ⊕ 208V RECEPTACLE WITH FUSIBLE DISCONNECT—HEIGHT AS INDICATED
- ⊕ 480V RECEPTACLE WITH FUSIBLE DISCONNECT—HEIGHT AS INDICATED
- EC ELECTRICAL CONTRACTOR
- MC MECHANICAL CONTRACTOR
- GC GENERAL CONTRACTOR
- WP WEATHER PROOF

SYMBOLS

- CSV MOTOR COMBINATION STARTER, FUSIBLE HAND-OFF-AUTO SEL. SW., PILOT LIGHT, STARTER SIZE AS INDICATED. ELECTRONIC OVERLOADS. TOP OF HANDLE NO MORE THAN 54" AFF.
- U 30 AMP UNFUSED DISCONNECT—TOP OF HANDLE NO MORE THAN 54" AFF.
- 50V 60 AMP FUSED DISCONNECT WITH 50 AMP FUSES — TOP OF HANDLE NO MORE THAN 54" AFF.
- P POWER BOX
- D DATA BOX
- SC LOW VOLTAGE SPEED CONTROL SWITCH
- 80A F INTERLOCKED DISCONNECT/RECEPTACLE
- CP CONTROL PANEL
- 1/2 HP MOTOR
- EWC ELECTRIC WATER COOLER
- VIF VERIFY IN FIELD
- EWH ELECTRIC WATER HEATER
- EBB ELECTRIC BASEBOARD HEATER
- RH RADIANT HEATERS
- UH UNIT HEATER
- FC FAN COIL
- MUA MAKE UP AIR UNIT
- P PUMP
- IG ISOLATED GROUND
- NL NIGHT LIGHT
- LC LIGHTING CONTRACTOR
- P PHOTOCELL
- TC TIME CLOCK
- R RELAY
- PULL STATION—OPERATING HANDLE NOT MORE THAN 48" AFF
- AV HORN/STROBE—80" AFF
- A HORN—80" AFF
- V STROBE—80" AFF
- F WATER FLOW SWITCH
- T TAMPER SWITCH
- DD DUCT SMOKE DETECTOR
- RT REMOTE TEST STATION
- CO CO DETECTOR
- B SPRINKLER BELL/STROBE
- I INDIVIDUAL ADDRESSABLE MODULE
- RM INDIVIDUAL ADDRESSABLE RELAY MODULE
- PL POWER LOSS RELAY MODULE
- HO DOOR HOLD OPEN
- MR FIRE PUMP MOTOR RUNNING
- LP FIRE PUMP LOSS OF PHASE
- PR FIRE PUMP PHASE REVERSAL
- AS FIRE PUMP ALTERNATE SOURCE
- LT LOW TEMPERATURE
- WL WATER LEVEL LOWERED
- WR WATER LEVEL RESTORED
- P LOW PRESSURE
- GAS DETECTION HORN/STROBE PROVIDE BOX AND 1/2" ENT UP TO 5 DIST AREA. MOUNT BOX AT 5' AFF.
- SF FAN SPEED CONTROL SWITCH TOP 48" AFF
- PROVIDE BOX AND 1/2" CONDUIT TO ABOVE BOTTOM OF JOIST IN HIGH BAY AREAS OR ABOVE CEILING GRID IN OFFICE AREAS. IN LOW BAY SHOP AREAS, CONDUIT SHALL BE RUN FROM THE THERMOSTAT TO THE HVAC EQUIPMENT. THERMOSTAT SENSOR AND LOW VOLTAGE WIRING BY HVAC CONTRACTOR.
- PROVIDE BOX AND 1/2" CONDUIT TO ABOVE BOTTOM OF JOIST IN HIGH BAY AREAS OR ABOVE CEILING GRID IN OFFICE AREAS. IN LOW BAY SHOP AREAS, CONDUIT SHALL BE RUN FROM THE PRESSURE SENSOR TO THE HVAC EQUIPMENT. PRESSURE SENSOR AND LOW VOLTAGE WIRING BY HVAC CONTRACTOR.
- PROVIDE BOX (IF NEEDED) AND 3/4" CONDUIT UP TO CEILING FOR MUA CONTROL PANEL. LOW VOLTAGE WIRING BY HVAC CONTRACTOR.
- EXPLOSION PROOF
- EMERGENCY LIGHTING CONTROL UNIT WATTSTOPPER ELCU-200 OR EQUAL.

- OS1 WALL SWITCH INFARED OCCUPANCY SENSOR LEVITON ODS15-ID OR EQUAL.
- OS2 WALL MOUNT INFARED, 115 DEGREE, 2500 SQ FT. OCCUPANCY SENSOR. LEVITON OSW15-IOW OR EQUAL. INCLUDE LEVITON OSP20-000 POWER PACK.
- OS3 DUAL RELAY WALL SWITCH MULTI-TECHNOLOGY OCCUPANCY SENSOR. LEVITON OSSMD-GD OR EQUAL.
- OS4 INFARED CEILING MOUNT, 360 DEGREE, 450 SQ FT. OCCUPANCY SENSOR. LEVITON OSC04-IOW OR EQUAL. INCLUDE LEVITON OSP20-000 POWER PACK.
- OS5 MULTI-TECHNOLOGY CEILING MOUNT, 180 DEGREE, 500 SQ FT. OCCUPANCY SENSOR. LEVITON OSC05-MOW OR EQUAL. INCLUDE LEVITON OSP20-000 POWER PACK.
- OS6 MULTI-TECHNOLOGY CEILING MOUNT, 360 DEGREE, 2000 SQ FT. OCCUPANCY SENSOR. LEVITON OSC20-MOW OR EQUAL. INCLUDE LEVITON OSP20-000 POWER PACK.
- OS7 ULTRASONIC CEILING MOUNT, 180 DEGREE, 500 SQ FT. OCCUPANCY SENSOR. LEVITON OSC05-UOW OR EQUAL. INCLUDE LEVITON OSP20-000 POWER PACK.
- OS8 INFARED CEILING MOUNT, 360 DEGREE, 1500 SQ FT. OCCUPANCY SENSOR. LEVITON OSC15-IOW OR EQUAL. INCLUDE LEVITON OSP20-000 POWER PACK.
- OS9 DUAL RELAY WALL SWITCH INFARED OCCUPANCY SENSOR. LEVITON ODS0D-ID OR EQUAL.
- OS10 WALL MOUNT MULTI-TECHNOLOGY, 115 DEGREE, 1200 SQ FT. OCCUPANCY SENSOR. LEVITON OSW12-MOW OR EQUAL. INCLUDE LEVITON OSP20-000 POWER PACK.
- OS11 WALL SWITCH MULTI-TECHNOLOGY OCCUPANCY SENSOR LEVITON OSSMT-GD OR EQUAL.
- OS12 WALL SWITCH DUAL RELAY MULTI-TECHNOLOGY OCCUPANCY SENSOR WITH 10 MINUTE DELAYED OFF ON SECOND RELAY FOR EXHAUST FAN. LEVITON OSSMD-ID OR EQUAL.
- OS13 ULTRASONIC CEILING MOUNT, 360 DEGREE, 2000 SQ FT. OCCUPANCY SENSOR. LEVITON OSC20-UOW OR EQUAL. INCLUDE LEVITON OSP20-000 POWER PACK.
- OS14 WALL MOUNT OUTDOOR INFARED, 270 DEGREE, OCCUPANCY SENSOR. WATT STOPPER EW-205-24-W OR EQUAL. INCLUDE B2-50 POWER PACK AS REQUIRED.
- OS15 LIGHTOLIER INTELLISIGHT ITSCSHB HIGH BAY CEILING OCCUPANCY SENSOR OR EQUAL. INCLUDE ITRSP1U SINGLE RELAY, ITRSP2U TWO RELAY OR ITRSP4U FOUR RELAY POWER PACK AS REQUIRED.
- OS16 MULTI-TECHNOLOGY CEILING MOUNT, 360 DEGREES, 1000 SQ FT. OCCUPANCY SENSOR. LEVITON OSC10-MOW OR EQUAL. INCLUDE LEVITON OSP20-000 POWER PACK.
- OS17 LONG-RANGE INFARED WALL-MOUNT, 110 DEGREES, 100 FOOT RANGE, OCCUPANCY SENSOR. LEVITON OSWLR-IOW OR EQUAL. INCLUDE LEVITON OSP20-000 POWER PACK.
- OS18 ULTRASONIC CEILING MOUNT, 180 DEGREE, 1,000 SQ FT. OCCUPANCY SENSOR. LEVITON OSC10-UOW OR EQUAL. INCLUDE LEVITON OSP20-000 POWER PACK.

TYPICAL:
IN ROOMS WITH MULTIPLE OCCUPANCY SENSORS, THE SENSORS SHALL BE WIRED TO A COMMON POWER PACK OR POWER PACKS AS REQUIRED UNLESS SHOWN OR NOTED OTHERWISE.
KEEP ULTRASONIC AND MULTI-TECHNOLOGY SENSORS AT LEAST 6" FROM HVAC DUCT OPENINGS. VERIFY OCCUPANCY SENSOR LOCATIONS WITH OWNER AND ARCHITECT FOR ANY FUTURE SHELVING OR OTHER ITEMS THAT MAY BLOCK THE SENSING RANGE.
"OR EQUAL" MEANS SENSORS AND POWER PACKS WITH THE SAME SENSING RANGE, FUNCTIONS AND NUMBER OF SENSORS PER POWER PACK AS SPECIFIED ABOVE.

OCCUPANCY SENSOR TIME DELAY:
SET ALL OFFICE, HALL, SMALL STORAGE AND PARTS OCCUPANCY SENSOR TIME DELAYS TO 5 MINUTES. SET ALL SMALL VEHICLE STORAGE, LARGE VEHICLE STORAGE AND WELD BAY OCCUPANCY SENSOR TIME DELAYS TO 10 MINUTES.

ELECTRICAL CONTRACTOR TO PROVIDE POWER TO OVERHEAD DOOR BOXES (FOR PHOTO EYES) AND MOUNT PUSH BUTTON STATION. ELECTRICAL CONTRACTOR WILL ALSO PROVIDE CONDUIT FROM OVERHEAD DOOR CONTROL BOX TO PUSH BUTTON STATIONS AND BOXES. A SINGLE POLE LIGHT SWITCH IS ALSO REQUIRED TO DISABLE THE OVERHEAD DOOR. ELECTRICAL CONTRACTOR TO PROVIDE SWITCH AND LABEL "DISABLE OVERHEAD DOOR".

SOME DOORS REQUIRE A LOOP DETECTOR TO SENSE VEHICLES APPROACHING (SEE PLANS). PROVIDE A PVC CONDUIT FROM A BOX INSIDE THE BUILDING TO THE LOOP. VERIFY LOCATION WITH DOOR CONTRACTOR.

DOOR CONTRACTOR TO PROVIDE AND MOUNT MOTOR AND PHOTO EYES. DOOR CONTRACTOR TO PROVIDE PUSH BUTTON TO EC TO MOUNT. DOOR CONTRACTOR TO WIRE PHOTO EYES AND PUSH BUTTON STATION. DOOR CONTRACTOR TO WIRE DISABLE SWITCH. DOOR CONTRACTOR TO WIRE LOOP DETECTOR(S) IF PRESENT.

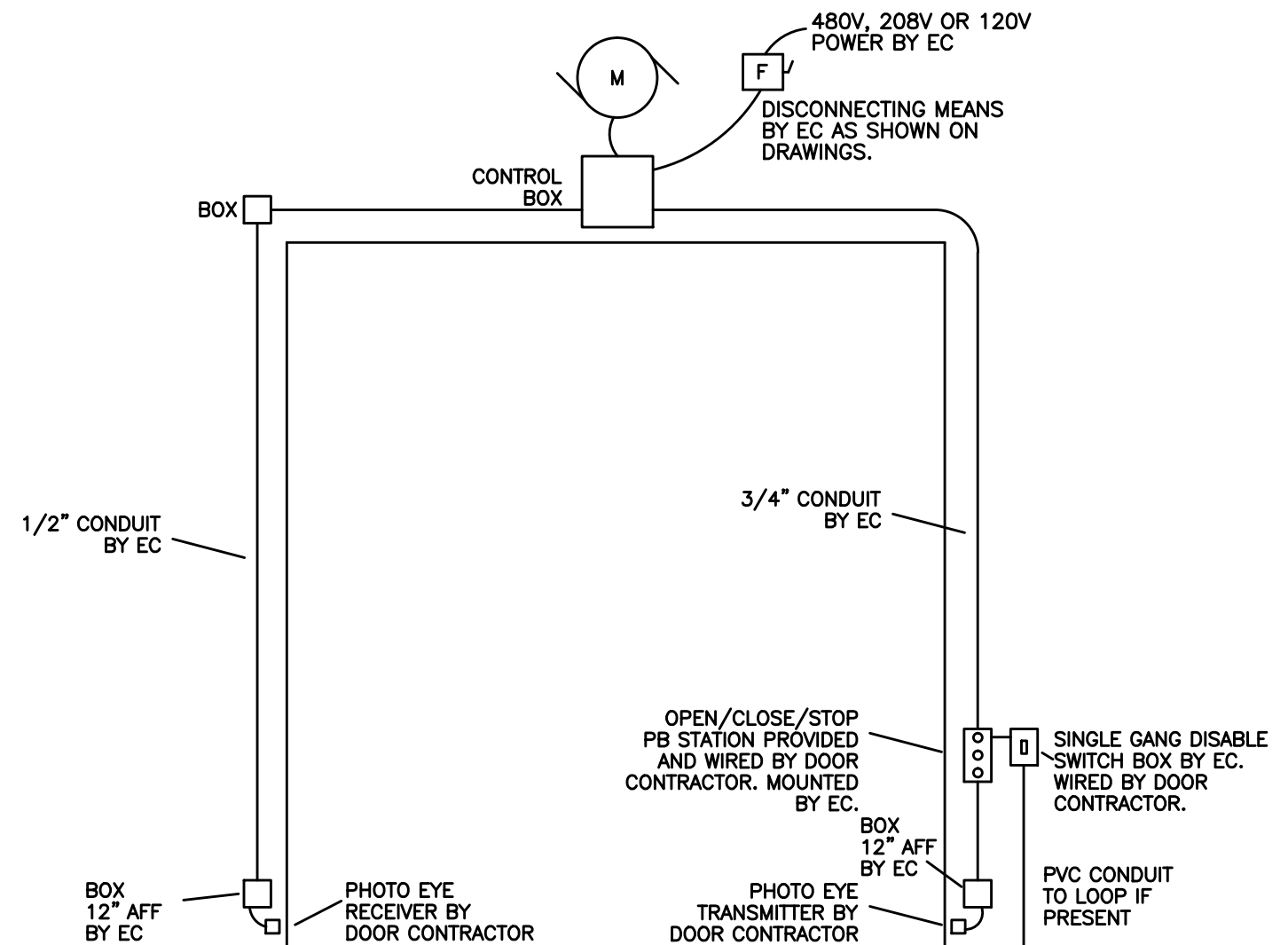

1 TYPICAL: OVERHEAD DOOR

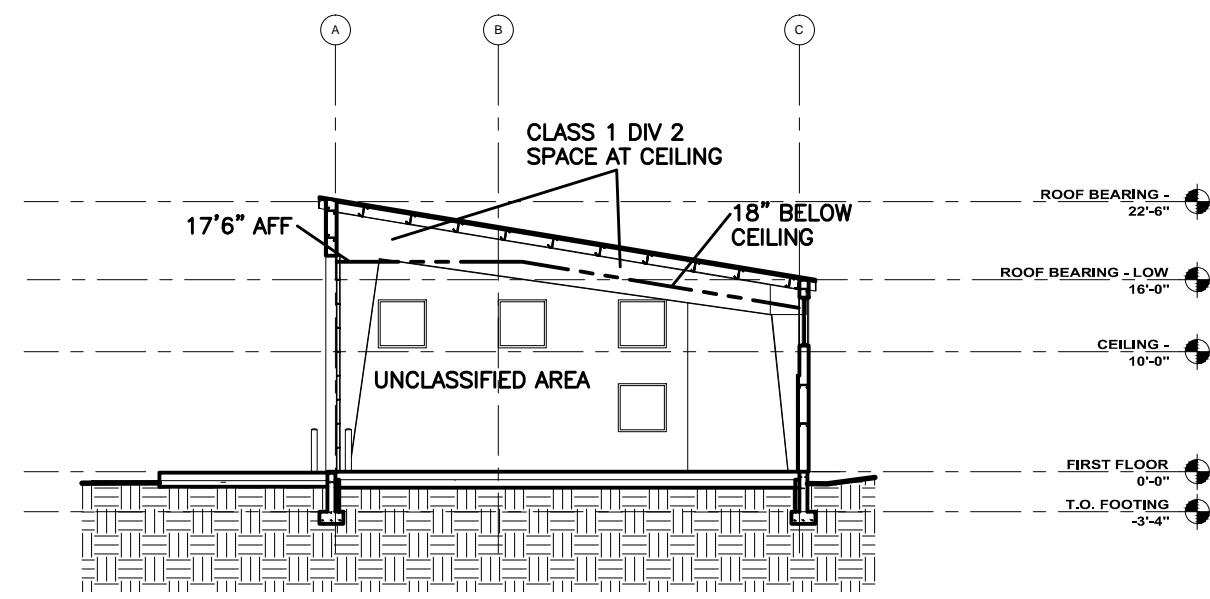

2 CNG CLASSIFIED CEILING SPACE
1/16" = 1'

LIGHT FIXTURE SCHEDULE											
TYPE	DESCRIPTION	MANUFACTURER	CATALOG NUMBER	VOLTAGE	LAMP NO.	LAMP	BALLAST	AMPS	WATTS	MOUNT	NOTES
V	2X4 TROFFER LED	LITHONIA	2TL4-60L-FW-A19-MVOLT-EZ1-LP840	120	LED	LED, 4000K, 4,800 LUMENS	LED DIMMING DRIVER	.39	47	GRID	22
W	LED HIGH BAY WITH HIGH BAY 360 DEGREE MOTION SENSOR	LITHONIA	IBL-12L-WD-SD125-MVOLT-LP740DLC-CS93W-DWH-ZACVH-MSE360	120	LED	LED, 4000K, 12,000 LUMENS	LED DIMMING DRIVER	1.04	125	AIRCRAFT CABLE	4, 20
Y	LED HIGH BAY WITH LOW BAY 360 DEGREE MOTION SENSOR	LITHONIA	IBL-12L-WD-SD125-MVOLT-LP740DLC-CS93W-DWH-ZACVH-MSE360LB	120	LED	LED, 4000K, 12,000 LUMENS	LED DIMMING DRIVER	1.04	125	AIRCRAFT CABLE	4, 20
EM1	EMERGENCY LIGHT	LITHONIA	ELM818	120/277	2	MR24 K9085, 8V, 9W KRYPTON		.167/.07	5.8	SURFACE	
EM3	EMERGENCY LIGHT LESS HEADS	LITHONIA	ELM818-RO	120	-	8V, 18W CAPACITY FOR REMOTE HEAD		.167	5.2	SURFACE	
EMR	REMOTE EMERGENCY LIGHT	LITHONIA	ELA-AFNR-DB-FWD	6	2	8V, 6W XENON		2.0	12	SURFACE	7
X3	COMBINATION EMERGENCY LIGHT/LED EXIT SECURITY	LITHONIA	LHQM-LED-R	120	3	L.E.D. PANEL, 2 9.6V, 1.5W LED		.05	4.3	SURFACE	
OE	SECURITY	LITHONIA	DSKW1-LED-20C-700-40K-T3M-120-SF-HS-DOBXD-BBW	120		4000K LED, 4.431 LUMENS	700mA LED DRIVER	.44	47	SURFACE	3,7.8

- SCHEDULE NOTES**
- DUAL SWITCHING - REQUIRES STEP DIMMING OR MULTIPLE BALLASTS OR LED DRIVERS AS SPECIFIED.
 - WHITE OPEN DOWNLIGHT.
 - INCLUDE FUSE OPTION.
 - INCLUDE PREWIRED 360 DEGREE MOTION SENSOR.
 - INCLUDE GUARD AND HEAVY DUTY PRISMATIC LENS.
 - WHITE SPLAY, TEMPERED PRISMATIC LENS.
 - DARK BRONZE
 - INCLUDES HOUSE SIDE SHIELD OR BACK LIGHT CONTROL.
 - 120V AT SALT SHED, 277V AT MAIN BUILDING.
 - INCLUDE LITHONIA SSA-25-4C-DM19AS-DOBXD, DARK BRONZE, .1196" THICK, 4" SQUARE STEEL POLE.
 - INCLUDE STAINLESS STEEL HARDWARE AND LENS RING, CORROSION RESISTANT FINISH, WET LOCATION LABEL, STAINLESS STEEL SAFETY CHAIN OR CABLE.
 - LEAD CALCIUM BATTERY.
 - BLACK BAFFLE, FLAT FRESNEL LENS.
 - UNIVERSAL VOLTAGE.
 - INCLUDE LEVITON OSFLA-ITW OCCUPANCY SENSOR WITH HIGH BAY, LOW BAY AND ISLE LENS AND OFFSET ADAPTER BRACKET OR EQUAL AND MOUNT ON FIXTURE. USE LOW BAY LENS.
 - FLAT BEAM LED FLOOD WITH 27-5/8" OUTRIGGER ARM AND MOUNTING CANOPY.
 - 120V AT FIRE PUMP BUILDING, 277V ON MAIN BUILDING.
 - INCLUDE BACK BOX.
 - HIGH TEMPERATURE NI-CAD BATTERY. LISTED FOR DAMP LOCATION, 32 TO 131 DEG F.
 - DIMMING OR BI-LEVEL DIMMING NOT NEEDED.
 - NO ALTERNATE BID FOR TYPE N. USE SAME TYPE N AS BASE BID.
 - A19 #19 PATTERN ACRYLIC .156" LENS.
 - LOWER LEVEL MAIN BUILDING AREAS AND SATELLITE BUILDING.
 - PUMP ENCLOSURE, FIRE PUMP BUILDING, ALL LIGHTS SHOWN ON LIGHTING PLAN E-204. +41 DEG F TO 105 DEG F AMBIENT.
 - ALL LIGHTS SHOWN ON LIGHTING PLAN E-204. +41 DEG F TO 105 DEG F AMBIENT.
 - LOWER LEVEL MAIN BUILDING AREAS.
 - INCLUDE OCCUPANCY SENSOR WITH HIGH AND LOW BAY LENSES.
 - INCLUDE GUARD AND HEAVY DUTY FROSTED LENS.
 - +131 DEGREE AMBIENT TEMPERATURE.
 - +149 DEGREE AMBIENT TEMPERATURE, CORROSION RESISTANT FINISH, DUAL FUSES, GLASS LENS, WHITE FINISH.
 - 10' AIRCRAFT CABLE WITH Y HANGAR.
 - CORD AND PLUG MOUNT. PROVIDE TWIST LOCK RECEPTACLE.
 - 0-10VDC DIMMING TO 1%.
- GENERAL NOTES**
- UNLESS NOTED, EQUIVALENT FIXTURES FROM THE FOLLOWING MANUFACTURERS WILL BE ACCEPTED: GENLYTE THOMAS (DAY-BRITE, CAPRI, OMEGA, EMCO, MOPHILBEN), HUBBELL LIGHTING (COLUMBIA, PRESOLITE, SPAULDING, DUAL LITE), RUUD, GREE, LSI AND COOPER LIGHTING (METALUX, HALO, LUMARK, SURE-LITES). EQUIVALENT LIGHT FIXTURES WILL BE EQUAL OR BETTER THAN THE SPECIFIED FIXTURE. ANY LIGHT FIXTURE THAT IS NOT EQUAL WILL BE REJECTED.
 - FIXTURES SHALL BE LABELED WITH LAMP TYPE BY MANUFACTURER.

STARTER/CONTRACTOR/RELAY SCHEDULE												
DEVICE	LOCATION	LOAD	TYPE	FUSE	CONTROL TRANSFORMER	CONTROL COIL	LOAD HP/KW	LOAD VOLTAGE	LOAD PHASE	POLES	LOW VOLTAGE CONTROL RELAY	NOTES (SEE BELOW)
R4	SATELLITE BUILDING VEHICLE STORAGE 105	SEF-2	SPST POWER RELAY WITH ENCLOSURE, 40AMP CONTACT, 2HP MAX. RATING. SQUARE D 8501-C06* WITH 9991-U01 ENCLOSURE (*=VOLTAGE).	NONE	NONE	LOW VOLTAGE	.5 HP	120	1	1	NONE	3

OPTIONS AND NOTES:

- PRESS-TO-TEST PILOT LIGHT.
- MAN/OFF/AUTO SELECTOR SWITCH.
- LOW VOLTAGE RELAY COIL. VERIFY COIL VOLTAGE.
- STARTERS TO HAVE ELECTRONIC OVERLOAD PROTECTION.
- SEE SHEET E506, DETAIL 1.
- COMBINATION STARTER WIRED THE SAME AS SHEET E506, DETAIL 1 EXCEPT THE MOTOR IS SINGLE PHASE.
- VERIFY FUSE SIZE (125% OF FLA) WITH MOTOR NAMEPLATE DATA.
- STAINLESS STEEL ENCLOSURE.
- IEC STYLE STARTERS WILL NOT BE ACCEPTED.
- SEE SHEET E506, DETAIL 2.
- ON AND OFF PUSHBUTTONS.
- VFD WITH DISCONNECT PROVIDED AND PROGRAMMED BY HVAC CONTRACTOR. INSTALLED BY ELECTRICAL CONTRACTOR.

GENERAL NOTES:

- "OR EQUAL" MEANS EQUAL EQUIPMENT PROVIDED BY APPROVED MANUFACTURERS LISTED IN SPECIFICATIONS.