

RFB NO. 317047



CONSTRUCTION DOCUMENTS PROJECT MANUAL

DANE COUNTY DEPARTMENT OF PUBLIC WORKS,
HIGHWAY AND TRANSPORTATION

PUBLIC WORKS ENGINEERING DIVISION
1919 ALLIANT ENERGY CENTER WAY
MADISON, WISCONSIN 53713

REQUEST FOR BIDS NO. 317047
FRYES FEEDER CREEK SNOWMOBILE BRIDGE
DONALD COUNTY PARK
1945 STATE HWY 92
MT. HOREB, WISCONSIN

Due Date / Time: **TUESDAY, JANUARY 23, 2018 / 2:00 P.M.**

Location: **PUBLIC WORKS OFFICE**

Performance / Payment Bond: **100% OF CONTRACT AMOUNT**

Bid Deposit: **5% OF BID AMOUNT**

FOR INFORMATION ON THIS REQUEST FOR BIDS, PLEASE CONTACT:

RYAN SHORE, CPESC, PROJECT MANAGER
TELEPHONE NO.: 608/266-4475
FAX NO.: 608/267-1533
E-MAIL: SHORE@COUNTYOFDANE.COM

TABLE OF CONTENTS FOR RFB NO. 317047

DIVISION 00 - PROCUREMENT AND CONTRACTING REQUIREMENTS

- Project Manual Cover Page
- Table of Contents
- Advertisement for Bids (Legal Notice)
- Best Value Contracting Application
- Instructions to Bidders
- Bid Form
- Fair Labor Practices Certification
- Sample Public Works Contract
- Sample Bid Bond
- Sample Performance Bond
- Sample Payment Bond
- Equal Benefits Compliance Payment Certification Form
- Conditions of Contract
- Supplementary Conditions

DIVISION 01 - GENERAL REQUIREMENTS

- 01 00 00 – Basic Requirements
- 01 74 19 – Construction Waste Management, Disposal & Recycling

DIVISION 32 - EXTERIOR IMPROVEMENTS

- 32 34 00 – Prefabricated Steel Bridge

DRAWINGS

Plot drawings on 24" x 36" (ARCH D) paper for correct scale or size.

- Sheet No. 1 – Bridge Plans
- Sheet No. 2 – Bridge Details
- Attachment A – Bridge Site Plan
- Attachment B – Bridge Location Map

LEGAL NOTICE

INVITATION TO BID

Dane County Public Works, Highway & Transportation Dept., 1919 Alliant Energy Center Way, Madison, WI 53713, will receive sealed Bids until:

2:00 P.M., TUESDAY, JANUARY 23, 2018

REQUEST FOR BIDS NO. 317047

FRYES FEEDER CREEK SNOWMOBILE BRIDGE

DONALD COUNTY PARK

1945 STATE HIGHWAY 92

MT. HOREB, WISCONSIN

Dane County is inviting Bids for construction services for one snowmobile bridge, approximately 50-feet in length. The bridge is to be set on pan footings. Only firms with capabilities, experience & expertise with similar projects should obtain this Request for Bids document & submit Bids.

Request for Bids document may be obtained after **2:00 p.m. on January 2nd, 2018** by downloading it from bids-pwht.countyofdane.com. Please call Ryan Shore, CPESC, Project Manager, at 608/266-4475, or our office at 608/266-4018, for any questions or additional information.

All Bidders must be a registered vendor with Dane County & pay an annual registration fee & must be pre-qualified as a Best Value Contractor before award of Contract. Complete Vendor Registration Form at danepurchasing.com/Account/Login? or obtain one by calling 608/266-4131. Complete Pre-qualification Application for Contractors at countyofdane.com/pwht/BVC_Application.aspx or obtain one by calling 608/266-4029.

A pre-bid site tour will be held January 9, 2018 at 11:00 a.m. at Donald Park starting in the parking lot. Bidders are strongly encouraged to attend this tour.

PUBLISH: JANUARY 2ND & 9TH, 2018 - WISCONSIN STATE JOURNAL
JANUARY 2ND & 9TH, 2018 - THE DAILY REPORTER



DANE COUNTY DEPARTMENT of PUBLIC WORKS, HIGHWAY and TRANSPORTATION

County Executive
Joseph T. Parisi

1919 Alliant Energy Center Way • Madison, Wisconsin 53713
Phone: (608) 266-4018 • FAX: (608) 267-1533

Commissioner / Director
Gerald J. Mandli

BEST VALUE CONTRACTING APPLICATION

CONTRACTORS / LICENSURE APPLICANTS

The Dane County Department of Public Works requires all contractors to be pre-qualified as a best value contractor with the County prior to being awarded a contract. In addition, the County pre-qualifies potential contractors and sub-contractors who wish to work on County contracts. Subcontractors must become pre-qualified ten (10) days prior to commencing work under any Dane County Public Works Contract. Potential subcontractors are urged to become pre-qualified as early as possible. This document shall be completed, properly executed, along with the necessary attachments and additional information that the County requires for the protection and welfare of the public in the performance of a County contract.

Contractors or subcontractors of any tier who attain pre-qualification status will retain that status for a period of two (2) years from the date of qualification. Contractors shall notify the Dane County Department of Public Works, Highway & Transportation within fifteen (15) days of any changes to its business or operations that are relevant to the pre-qualification application. Failure to do so could result in suspension, revocation of the contractor's pre-qualification, debarment from County contracts for up to three (3) years and / or other sanctions available under the law.

No contracts will be awarded for construction work performed on Dane County projects unless the contractor is currently approved as a Wisconsin Trade Trainer or has applied for approval as an Apprenticeship Trade Trainer to the Wisconsin Department of Workforce Development and agrees to an acceptable apprenticeship program. If you are not currently approved as a Wisconsin Trade Trainer, or have not applied for approval as an Apprenticeship Trade Trainer, please contact the Department of Workforce Development - Bureau of Apprenticeship Standards at 608/266-3133 or visit their web site at: dwd.wisconsin.gov/apprenticeship/.

EXEMPTIONS

- Contractors who employ less than five (5) apprenticeable trade workers are not required to pre-qualify.
- Contractors performing work that does not apply to an apprenticeable trade, as outlined in Appendix A.
- The contractor / subcontractor provides sufficient documentation to demonstrate one or more of the following:
 - apprentices are not available in a specific geographic area;
 - the applicable apprenticeship program is unsuitable or unavailable; or
 - there is a documented depression of the local construction market which prevents compliance.

SEC.	PROOF OF RESPONSIBILITY	CHECK IF APPLICABLE
1	Does your firm possess all technical qualifications and resources, including equipment, personnel and financial resources, necessary to perform the work required for any project or obtain the same through the use of responsible, pre-qualified subcontractors?	Yes: <input type="checkbox"/> No: <input type="checkbox"/>
2	Will your firm possess all valid, effective licenses, registrations or certificates required by federal, state, county, or local law, which are necessary for the type of work to be performed including, but not limited to, those for any type of trade work or specialty work?	Yes: <input type="checkbox"/> No: <input type="checkbox"/>
3	Will your firm meet all bonding requirements as required by applicable law or contract specifications?	Yes: <input type="checkbox"/> No: <input type="checkbox"/>
4	Will your firm meet all insurance requirements as required by applicable law or specifications, including general liability insurance, workers compensation insurance and unemployment insurance requirements?	Yes: <input type="checkbox"/> No: <input type="checkbox"/>
5	Will your firm maintain a substance abuse policy for employees hired for public works contracts that comply with Wis. Stats. Sec. 103.503?	Yes: <input type="checkbox"/> No: <input type="checkbox"/>
6	Does your firm acknowledge that it must pay all craft employees on public works projects the wage rates and benefits required under Section 66.0903 of the Wisconsin Statutes?	Yes: <input type="checkbox"/> No: <input type="checkbox"/>
7	Will your firm fully abide by the equal opportunity and affirmative action requirements of all applicable laws, including County ordinances?	Yes: <input type="checkbox"/> No: <input type="checkbox"/>
8	In the past three (3) years, has your firm had control or has another corporation, partnership or other business entity operating in the construction industry controlled it? If so, please attach a statement explaining the nature of the firm relationship?	Yes: <input type="checkbox"/> No: <input type="checkbox"/> If Yes, attach details.
9	In the past three (3) years, has your firm had any type of business, contracting or trade license, certification or registration revoked or suspended?	Yes: <input type="checkbox"/> No: <input type="checkbox"/> If Yes, attach details.
10	In the past three (3) years, has your firm been debarred by any federal, state or local government agency?	Yes: <input type="checkbox"/> No: <input type="checkbox"/> If Yes, attach details.
11	In the past three (3) years, has your firm defaulted or failed to complete any contract?	Yes: <input type="checkbox"/> No: <input type="checkbox"/> If Yes, attach details.
12	In the past three (3) years, has your firm committed a willful violation of federal, state or local government safety laws as determined by a final decision of a court or government agency authority.	Yes: <input type="checkbox"/> No: <input type="checkbox"/> If Yes, attach details.
13	In the past three (3) years, has your firm been in violation of any law relating to your contracting business where the penalty for such violation resulted in the imposition of a penalty greater than \$10,000?	Yes: <input type="checkbox"/> No: <input type="checkbox"/> If Yes, attach details.
14	Is your firm Executive Order 108 precertified with the State of Wisconsin?	Yes: <input type="checkbox"/> No: <input type="checkbox"/>
15	Is your firm an active Wisconsin Trade Trainer as determined by the Wisconsin Bureau of Apprenticeship Standards?	Yes: <input type="checkbox"/> No: <input type="checkbox"/>
16	Is your firm exempt from being pre-qualified with Dane County?	Yes: <input type="checkbox"/> No: <input type="checkbox"/> If Yes, attach reason for exemption.
17	Does your firm acknowledge that in doing work under any County Public Works Contract, it will be required to use as subcontractors only those contractors that are also pre-qualified with the County or become so ten days prior to commencing work?	Yes: <input type="checkbox"/> No: <input type="checkbox"/>
18	Contractor has been in business less than one year?	Yes: <input type="checkbox"/> No: <input type="checkbox"/>
19	Is your firm a first time Contractor requesting a one time exemption, but, intend to comply on all future contracts and are taking steps typical of a "good faith" effort?	Yes: <input type="checkbox"/> No: <input type="checkbox"/>
20	Not applicable. My firm does not intend to work on Best Value Contracts. Note: Best Value Contracting is required to bid on most Public Works Contracts (if unclear, please call Jan Neitzel Knox 608-266-4029).	Yes: <input type="checkbox"/> No: <input type="checkbox"/>

SIGNATURE SECTION

Your firm's Officer, or the individual who would sign a bid and / or contract documents must sign this document.

I do hereby certify that all statements herein contained are true and correct to the best of my knowledge:

Signature

Date

Printed or Typed Name and Title

NAME AND ADDRESS OF CONTRACTOR	
Name of Firm:	
Address:	
City, State, Zip:	
Telephone Number:	
Fax Number:	
E-mail Address:	

REMEMBER!

Return all to forms and attachments, or questions to:

JAN NEITZEL KNOX
EMAIL: NEITZEL-KNOX@COUNTYOFDANE.COM
OFFICE: (608)266-4029, FAX: (608)267-1533

**DANE COUNTY DEPARTMENT OF PUBLIC WORKS,
HIGHWAY & TRANSPORTATION
1919 ALLIANT ENERGY CENTER WAY
MADISON, WI 53713**

APPENDIX A

APPRENTICEABLE TRADES

Bricklayer
Carpenter
Cement Mason (Concrete Finisher)
Cement Mason (Heavy Highway)
Construction Craft Laborer
Data Communications Installer
Electrician
Elevator Mechanic / Technician
Environmental Systems Technician / HVAC Service Technician / HVAC Install & Service
Glazier
Heavy Equipment Operator / Operating Engineer
Insulation Worker (Heat & Frost)
Iron Worker (Assembler, Metal Buildings)
Painter / Decorator
Plasterer
Plumber
Roofer / Waterproofer
Sheet Metal Worker
Sprinkler Fitter
Steamfitter (Service & Refrigeration)
Taper & Finisher
Telecommunications (Voice, Data & Video) Installer / Technician
Tile Setter

INSTRUCTIONS TO BIDDERS

**Fryes Feeder Creek Snowmobile Bridge
Donald Park
1945 State Hwy 92
Mt. Horeb, Wisconsin**

1. SECURING DOCUMENTS

- A. Construction Documents may be obtained at bids-pwht.countyofdane.com.
- B. Bidder is responsible to check Public Works website regularly for Addenda.

2. BID REQUIREMENTS

- A. Bidder shall submit lump sum bid for providing all labor, equipment, tools and materials necessary to perform all Work described in Construction Documents. Only firms with capabilities, experience and expertise with similar projects should submit Bids.
- B. Envelope containing Bid shall be clearly marked as for this project (note title at top of page). Bids shall be delivered to:

Dane County Department of Public Works, Highway & Transportation
1919 Alliant Energy Center Way
Madison, Wisconsin 53713

- C. One (1) Bid Form shall be submitted with your Bid. Bid Form is provided with Construction Documents; no other form or letter shall be accepted.
- D. Wisconsin Statute 77.54 (9m) allows building materials that become part of local unit government facilities to be exempt from sales & use tax. Vendors & materials suppliers may not charge Bidders sales & use tax on these purchases. This does not include highways, streets or roads.
- E. Bidders shall not add any conditions, escalator clauses or qualifying statements to Bid Form.
- F. Erasures or other changes to Bid must be explained or noted, and shall be accompanied by initials of bidder.
- G. Legally authorized official of bidder's organization shall sign Bids.
- H. Bidder's organization shall submit completed Fair Labor Practices Certification Form, included in these Construction Documents.
- I. Bid Bond shall be made payable to Dane County in amount of five percent (5%) of bid amount. Bid Bond shall be either certified check or bid bond issued by surety licensed to conduct business in the State of Wisconsin. Successful bidder's Bid Bond shall be retained until Contract is signed and required Performance / Payment Bond is submitted. Bids shall be binding on bidder for sixty (60) calendar days after Bid Due Date. Bid Bond must be submitted with Bid.
- J. Successful bidder shall furnish and pay for Performance / Payment Bond as called for in Conditions of Contract.

3. INQUIRIES

- A. Written inquiries regarding intent of Construction Documents should be directed to:

Ryan Shore, Public Works Project Manager
Dane County Department of Public Works, Highway & Transportation
1919 Alliant Energy Center Way, Madison, Wisconsin 53713
Fax: 608/267-1533
Email: shore@countyofdane.com

- B. Bidders shall bring questions, discrepancies, omissions, conflicts or doubt as to meaning of any part of Construction Documents to attention of Department of Public Works, Highway & Transportation at least ten (10) business days before due date for Bids. Prompt clarification of intent of Construction Documents shall be made available to bidders in form of Addendum. Bidder shall acknowledge all Addenda on Bid Form.
- C. Failure to request clarification of interpretation of Construction Documents shall not relieve bidders of their responsibilities to perform Work.

4. EXAMINATION OF SITE

- D. A bidder's facility tour will be held on January 9, 2018 at 11:00 a.m. at Donald Park, 1945 State Hwy 92, Mt. Horeb, starting in the parking lot. This tour will go until approximately 11:30 a.m. Bidders are strongly encouraged to attend this tour, however attendance is optional.

5. ALTERNATES

- A. Not used.

6. WITHDRAWAL OF BIDS

- A. Any bidder may withdraw their Bid any time prior to Bid Due Date. Withdrawn Bids shall be returned unopened.

7. BID DUE DATE

- A. See Legal Notice (advertisement).

8. COMMENCEMENT AND COMPLETION OF WORK

- A. Work shall commence by February 28th, 2018.
- B. Work shall be completed by May 15th, 2018.

9. RESERVATION

- A. Dane County reserves the right to reject any or all Bids, to waive any informalities in the Bid, and to accept any Bid which shall be in the best interest of Dane County.

Name of Bidding Firm: _____

BID FORM

BID NO. 317047

**PROJECT: FRYES FEEDER CREEK SNOWMOBILE BRIDGE
DONALD COUNTY PARK**

**TO: DANE COUNTY DEPARTMENT OF PUBLIC WORKS, HIGHWAY &
TRANSPORTATION PROJECT MANAGER
1919 ALLIANT ENERGY CENTER WAY
MADISON, WISCONSIN 53713**

**NOTE: WISCONSIN STATUTE 77.54 (9M) ALLOWS FOR NO SALES & USE TAX ON
THE PURCHASE OF MATERIALS FOR COUNTY PUBLIC WORKS PROJECTS.**

BASE BID - LUMP SUM:

Dane County is inviting Bids for construction services for one snowmobile bridge, approximately 50-feet in length. The bridge is to be set on pan footings. The undersigned, having examined the site where the Work is to be executed and having become familiar with local conditions affecting the cost of the Work and having carefully examined the Drawings and Specifications, all other Construction Documents and Addenda thereto prepared by Dane County Department of Public Works, Highway & Transportation hereby agrees to provide all labor, materials, equipment and services necessary for the complete and satisfactory execution of the entire Work, as specified in the Construction Documents, for the Base Bid stipulated sum of:

_____ and _____ /100 Dollars
Written Price

\$ _____
Numeric Price

Receipt of the following addenda and inclusion of their provisions in this Bid is hereby acknowledged:

Addendum No(s). _____ through _____

Dated _____

Dane County Public Works must have this project completed by May 15, 2018. Assuming this Work can be started by February 28, 2018, what dates can you commence and complete this job?

Commencement Date: _____ Completion Date: _____
(final, not substantial)

I hereby certify that all statements herein are made on behalf of:

(Name of Corporation, Partnership or Person submitting Bid)

Select one of the following:

1. A corporation organized and existing under the laws of the State of _____, or
2. A partnership consisting of _____, or
3. A person conducting business as _____;

Of the City, Village, or Town of _____ of the State of _____.

I have examined and carefully prepared this Bid from the associated Construction Documents and have checked the same in detail before submitting this Bid; that I have full authority to make such statements and submit this Bid in (its) (their) (my) behalf; and that the said statements are true and correct. In signing this Bid, we also certify that we have not, either directly or indirectly, entered into any agreement or participated in any collusion or otherwise taken any action in restraint of free competition; that no attempt has been made to induce any other person or firm to submit or not to submit a Bid; that this Bid has been independently arrived at without collusion with any other bidder, competitor, or potential competitor; that this Bid has not been knowingly disclosed prior to the Bids Due Date to another bidder or competitor; that the above statement is accurate under penalty of perjury.

The undersigned further agrees to honor the Base Bid and the Alternate Bid(s) for sixty (60) calendar days from date of Award of Contract.

SIGNATURE: _____
(Bid is invalid without signature)

Print Name: _____ Date: _____

Title: _____

Address: _____

Telephone No.: _____ Fax No.: _____

Email Address: _____

Contact Person: _____

THIS PAGE IS FOR BIDDERS' REFERENCE AND NEED NOT BE SUBMITTED WITH BID FORM.

BID CHECK LIST:

These items **must** be included with Bid:

- Bid Form Bid Bond Fair Labor Practices Certification
 Project Experience / Reference Summary

BIDDERS SHOULD BE AWARE OF THE FOLLOWING:

DANE COUNTY VENDOR REGISTRATION PROGRAM

Any person bidding on any County contract must be registered with the Dane County Purchasing Division & pay an annual registration fee. A contract will not be awarded to an unregistered vendor. Obtain a *Vendor Registration Form* by calling 608/266-4131 or complete a new form or renewal online at:
www.danepurchasing.com/registration

DANE COUNTY BEST VALUE CONTRACTING PRE-QUALIFICATION

Contractors must be pre-qualified as a Best Value Contractor with the Dane County Public Works Engineering Division before the award of contract. Obtain a *Best Value Contracting Application* by calling 608/266-4018 or complete one online at:
www.countyofdane.com/pwht/BVC_Application.aspx

EQUAL BENEFITS REQUIREMENT

By submitting a Bid, the contractor acknowledges that a condition of this contract is to provide equal benefits as required by Dane County Code of Ordinances Chapter 25.13. Contractor shall provide equal benefits as required by that Ordinance to all required employees during the term of the contract. Equal Benefits Compliance Payment Certification shall be submitted with final pay request. For more information:
www.danepurchasing.com/partner_benefit.aspx

FAIR LABOR PRACTICES CERTIFICATION

The undersigned, for and on behalf of the BIDDER, APPLICANT or PROPOSER named herein, certifies as follows:

- A. That he or she is an officer or duly authorized agent of the above-referenced BIDDER, APPLICANT or PROPOSER, which has submitted a bid, application or proposal for a contract or agreement with the county of Dane.
- B. That BIDDER, APPLICANT or PROPOSER has (check one):

_____ not been found by the National Labor Relations Board (“NLRB”) or the Wisconsin Employment Relations Commission (“WERC”) to have violated any statute or regulation regarding labor standards or relations in the seven years prior to the signature date of this Certification.

_____ been found by the National Labor Relations Board (“NLRB”) or the Wisconsin Employment Relations Commission (“WERC”) to have violated any statute or regulation regarding labor standards or relations in the seven years prior to the signature date of this Certification.

Officer or Authorized Agent Signature	Date
Printed or Typed Name and Title	
Printed or Typed Business Name	

NOTE: You can find information regarding the violations described above at: www.nlr.gov and werc.wi.gov.

For reference, Dane County Ordinance 25.11(28)(a) is as follows:
(28) BIDDER RESPONSIBILITY. (a) Any bid, application or proposal for any contract with the county, including public works contracts regulated under chapter 40, shall include a certification indicating whether the bidder has been found by the National Labor Relations Board (NLRB) or the Wisconsin Employment Relations Committee (WERC) to have violated any statute or regulation regarding labor standards or relations within the last seven years. The purchasing manager shall investigate any such finding and make a recommendation to the committee, which shall determine whether the conduct resulting in the finding affects the bidder’s responsibility to perform the contract.

If you indicated that the NLRB or WERC have found you to have such a violation, you must include copies of any relevant information regarding such violation with your proposal, bid or application.

Include this completed Certification with your bid, application or proposal.

COUNTY OF DANE

PUBLIC WORKS CONSTRUCTION CONTRACT

Contract No. _____ Bid No. 317047

Authority: 2018 RES - _____

THIS CONTRACT, made and entered into as of the date by which authorized representatives of both parties have affixed their signatures, by and between the County of Dane (hereafter referred to as "COUNTY") and _____ (hereafter, "CONTRACTOR"), and

WITNESSETH:

WHEREAS, COUNTY, whose address is c/o Assistant Public Works Director, 1919 Alliant Energy Center Way, Madison, WI 53713, desires to have CONTRACTOR provide Fryes Feeder Creek Snowmobile Bridge ("the Project"); and

WHEREAS, CONTRACTOR, whose address is _____ is able and willing to construct the Project, in accordance with the Construction Documents;

NOW, THEREFORE, in consideration of the above premises and the mutual covenants of the parties hereinafter set forth, the receipt and sufficiency of which is acknowledged by each party for itself, COUNTY and CONTRACTOR do agree as follows:

1. CONTRACTOR agrees to construct, for the price of \$ _____ the Project and at the CONTRACTOR'S own proper cost and expense to furnish all materials, supplies, machinery, equipment, tools, superintendence, labor, insurance, and other accessories and services necessary to complete the Project in accordance with the conditions and prices stated in the Bid Form, Conditions of Contract, the drawings which include all maps, plats, plans, and other drawings and printed or written explanatory matter thereof, and the specifications therefore as prepared by Dane County Public Works, Highway & Transportation (hereinafter referred to as "the Architect / Engineer"), and as enumerated in the Project Manual Table of Contents, all of which are made a part hereof and collectively evidence and constitute the Contract.

2. COUNTY agrees to pay the CONTRACTOR in current funds for the performance of the Contract subject to additions and deductions, as provided in the Conditions of Contract, and to make payments on account thereof as provided in Article entitled, "Payments to Contractor" of the Conditions of Contract.

3. During the term of this Contract, CONTRACTOR agrees to take affirmative action to ensure equal employment opportunities. The CONTRACTOR agrees in accordance with Wisconsin Statute 111.321 and Chapter 19 of the Dane County Code of Ordinances not to discriminate on the basis of age, race, ethnicity, religion, color, gender, disability, marital status, sexual orientation, national origin, cultural differences, ancestry, physical appearance, arrest record or conviction record, military participation or membership in the national guard, state defense force or any other reserve component of the military forces of the United States, or political beliefs.

Such equal opportunity shall include, but not be limited to, the following: employment, upgrading, demotion, transfer, recruitment, advertising, layoff, termination, training, rates of pay, and any other form of compensation. CONTRACTOR agrees to post in conspicuous places, available to all employees and applicants for employment, notices setting forth the provisions of this paragraph.

4. CONTRACTOR shall file an Affirmative Action Plan with the Dane County Contract Compliance Officer in accord with Chapter 19 of the Dane County Code of Ordinances. CONTRACTOR must file such plan within fifteen (15) business days of the effective date of this Contract. During the term of this Contract CONTRACTOR shall also provide copies of all announcements of employment opportunities to COUNTY'S Contract Compliance Office, and shall report annually the number of persons, by race, ethnicity, gender, and disability status, which apply for employment and, similarly classified, the number hired and number rejected.

5. During the term of this Contract, all solicitations for employment placed on CONTRACTOR'S behalf shall include a statement to the effect that CONTRACTOR is an "Equal Opportunity Employer".

6. CONTRACTOR agrees to comply with provisions of Chapter 25.13 of the Dane County Code of Ordinances, which pertains to domestic partnership benefits.

7. CONTRACTOR agrees to furnish all information and reports required by COUNTY'S Contract Compliance Officer as the same relate to affirmative action and nondiscrimination, which may include any books, records, or accounts deemed appropriate to determine compliance with Chapter 19, Dane County Code of Ordinances, and the provisions of this Contract.

8. This Contract is intended to be a Contract solely between the parties hereto and for their benefit only. No part of this Contract shall be construed to add to, supplement, amend, abridge or repeal existing rights, benefits or privileges of any third party or parties including, but not limited to, employees of either of the parties.

9. The entire agreement of the parties is contained herein and this Contract supersedes any and all oral agreements and negotiations between the parties relating to the subject matter hereof. The parties expressly agree that the express terms of this Contract shall not be amended in any fashion except in writing, executed by both parties.

10. CONTRACTOR must be pre-qualified as a Best Value Contractor with Dane County Public Works Engineering Division before award of Contract. Subcontractors must be pre-qualified ten (10) business days prior to commencing Work under this Contract.

IN WITNESS WHEREOF, COUNTY and CONTRACTOR, by their respective authorized agents, have caused this Contract and its Schedules to be executed, effective as of the date by which all parties hereto have affixed their respective signatures, as indicated below.

* * * * *

FOR CONTRACTOR:

Signature Date

Printed or Typed Name and Title

Signature Date

Printed or Typed Name and Title

NOTE: If CONTRACTOR is a corporation, Secretary should attest. In accordance with IRS Regulations, unincorporated entities are required to provide either their Social Security or Employer Number in order to receive payment for services rendered.

* * * * *

This Contract is not valid or effectual for any purpose until approved by the appropriate authority designated below, and no work is authorized until the CONTRACTOR has been given notice to proceed by COUNTY'S Assistant Public Works Director.

FOR COUNTY:

Joseph T. Parisi, County Executive Date

Scott McDonell, County Clerk Date

AIA[®] Document A310[™] – 2010

Bid Bond

CONTRACTOR:

(Name, legal status and address)

SURETY:

(Name, legal status and principal place of business)

OWNER:

(Name, legal status and address)

BOND AMOUNT:**PROJECT:**

(Name, location or address, and Project number, if any)

This document has important legal consequences. Consultation with an attorney is encouraged with respect to its completion or modification.

Any singular reference to Contractor, Surety, Owner or other party shall be considered plural where applicable.

The Contractor and Surety are bound to the Owner in the amount set forth above, for the payment of which the Contractor and Surety bind themselves, their heirs, executors, administrators, successors and assigns, jointly and severally, as provided herein. The conditions of this Bond are such that if the Owner accepts the bid of the Contractor within the time specified in the bid documents, or within such time period as may be agreed to by the Owner and Contractor, and the Contractor either (1) enters into a contract with the Owner in accordance with the terms of such bid, and gives such bond or bonds as may be specified in the bidding or Contract Documents, with a surety admitted in the jurisdiction of the Project and otherwise acceptable to the Owner, for the faithful performance of such Contract and for the prompt payment of labor and material furnished in the prosecution thereof; or (2) pays to the Owner the difference, not to exceed the amount of this Bond, between the amount specified in said bid and such larger amount for which the Owner may in good faith contract with another party to perform the work covered by said bid, then this obligation shall be null and void, otherwise to remain in full force and effect. The Surety hereby waives any notice of an agreement between the Owner and Contractor to extend the time in which the Owner may accept the bid. Waiver of notice by the Surety shall not apply to any extension exceeding sixty (60) days in the aggregate beyond the time for acceptance of bids specified in the bid documents, and the Owner and Contractor shall obtain the Surety's consent for an extension beyond sixty (60) days.

If this Bond is issued in connection with a subcontractor's bid to a Contractor, the term Contractor in this Bond shall be deemed to be Subcontractor and the term Owner shall be deemed to be Contractor.

When this Bond has been furnished to comply with a statutory or other legal requirement in the location of the Project, any provision in this Bond conflicting with said statutory or legal requirement shall be deemed deleted herefrom and provisions conforming to such statutory or other legal requirement shall be deemed incorporated herein. When so furnished, the intent is that this Bond shall be construed as a statutory bond and not as a common law bond.

Signed and sealed this _____ day of _____

_____	(Contractor as Principal)	_____	(Seal)
(Witness)	_____	_____	(Title)
_____	(Surety)	_____	(Seal)
(Witness)	_____	_____	(Title)

CAUTION: You should sign an original AIA Contract Document, on which this text appears in RED. An original assures that changes will not be obscured.

AIA[®] Document A312[™] – 2010

Performance Bond

CONTRACTOR:

(Name, legal status and address)

SURETY:

(Name, legal status and principal place of business)

OWNER:

(Name, legal status and address)

This document has important legal consequences. Consultation with an attorney is encouraged with respect to its completion or modification.

Any singular reference to Contractor, Surety, Owner or other party shall be considered plural where applicable.

AIA Document A312–2010 combines two separate bonds, a Performance Bond and a Payment Bond, into one form. This is not a single combined Performance and Payment Bond.

CONSTRUCTION CONTRACT

Date:

Amount:

Description:

(Name and location)

BOND

Date:

(Not earlier than Construction Contract Date)

Amount:

Modifications to this Bond: None See Section 16

CONTRACTOR AS PRINCIPAL

Company: *(Corporate Seal)*

SURETY

Company: *(Corporate Seal)*

Signature: _____

Name _____
and Title: _____

Signature: _____

Name _____
and Title: _____

(Any additional signatures appear on the last page of this Performance Bond.)

(FOR INFORMATION ONLY — Name, address and telephone)

AGENT or BROKER:

OWNER'S REPRESENTATIVE:

(Architect, Engineer or other party:)

§ 1 The Contractor and Surety, jointly and severally, bind themselves, their heirs, executors, administrators, successors and assigns to the Owner for the performance of the Construction Contract, which is incorporated herein by reference.

§ 2 If the Contractor performs the Construction Contract, the Surety and the Contractor shall have no obligation under this Bond, except when applicable to participate in a conference as provided in Section 3.

§ 3 If there is no Owner Default under the Construction Contract, the Surety's obligation under this Bond shall arise after

- .1 the Owner first provides notice to the Contractor and the Surety that the Owner is considering declaring a Contractor Default. Such notice shall indicate whether the Owner is requesting a conference among the Owner, Contractor and Surety to discuss the Contractor's performance. If the Owner does not request a conference, the Surety may, within five (5) business days after receipt of the Owner's notice, request such a conference. If the Surety timely requests a conference, the Owner shall attend. Unless the Owner agrees otherwise, any conference requested under this Section 3.1 shall be held within ten (10) business days of the Surety's receipt of the Owner's notice. If the Owner, the Contractor and the Surety agree, the Contractor shall be allowed a reasonable time to perform the Construction Contract, but such an agreement shall not waive the Owner's right, if any, subsequently to declare a Contractor Default;
- .2 the Owner declares a Contractor Default, terminates the Construction Contract and notifies the Surety; and
- .3 the Owner has agreed to pay the Balance of the Contract Price in accordance with the terms of the Construction Contract to the Surety or to a contractor selected to perform the Construction Contract.

§ 4 Failure on the part of the Owner to comply with the notice requirement in Section 3.1 shall not constitute a failure to comply with a condition precedent to the Surety's obligations, or release the Surety from its obligations, except to the extent the Surety demonstrates actual prejudice.

§ 5 When the Owner has satisfied the conditions of Section 3, the Surety shall promptly and at the Surety's expense take one of the following actions:

§ 5.1 Arrange for the Contractor, with the consent of the Owner, to perform and complete the Construction Contract;

§ 5.2 Undertake to perform and complete the Construction Contract itself, through its agents or independent contractors;

§ 5.3 Obtain bids or negotiated proposals from qualified contractors acceptable to the Owner for a contract for performance and completion of the Construction Contract, arrange for a contract to be prepared for execution by the Owner and a contractor selected with the Owner's concurrence, to be secured with performance and payment bonds executed by a qualified surety equivalent to the bonds issued on the Construction Contract, and pay to the Owner the amount of damages as described in Section 7 in excess of the Balance of the Contract Price incurred by the Owner as a result of the Contractor Default; or

§ 5.4 Waive its right to perform and complete, arrange for completion, or obtain a new contractor and with reasonable promptness under the circumstances:

- .1 After investigation, determine the amount for which it may be liable to the Owner and, as soon as practicable after the amount is determined, make payment to the Owner; or
- .2 Deny liability in whole or in part and notify the Owner, citing the reasons for denial.

§ 6 If the Surety does not proceed as provided in Section 5 with reasonable promptness, the Surety shall be deemed to be in default on this Bond seven days after receipt of an additional written notice from the Owner to the Surety demanding that the Surety perform its obligations under this Bond, and the Owner shall be entitled to enforce any remedy available to the Owner. If the Surety proceeds as provided in Section 5.4, and the Owner refuses the payment or the Surety has denied liability, in whole or in part, without further notice the Owner shall be entitled to enforce any remedy available to the Owner.

§ 7 If the Surety elects to act under Section 5.1, 5.2 or 5.3, then the responsibilities of the Surety to the Owner shall not be greater than those of the Contractor under the Construction Contract, and the responsibilities of the Owner to the Surety shall not be greater than those of the Owner under the Construction Contract. Subject to the commitment by the Owner to pay the Balance of the Contract Price, the Surety is obligated, without duplication, for

- .1 the responsibilities of the Contractor for correction of defective work and completion of the Construction Contract;
- .2 additional legal, design professional and delay costs resulting from the Contractor's Default, and resulting from the actions or failure to act of the Surety under Section 5; and
- .3 liquidated damages, or if no liquidated damages are specified in the Construction Contract, actual damages caused by delayed performance or non-performance of the Contractor.

§ 8 If the Surety elects to act under Section 5.1, 5.3 or 5.4, the Surety's liability is limited to the amount of this Bond.

§ 9 The Surety shall not be liable to the Owner or others for obligations of the Contractor that are unrelated to the Construction Contract, and the Balance of the Contract Price shall not be reduced or set off on account of any such unrelated obligations. No right of action shall accrue on this Bond to any person or entity other than the Owner or its heirs, executors, administrators, successors and assigns.

§ 10 The Surety hereby waives notice of any change, including changes of time, to the Construction Contract or to related subcontracts, purchase orders and other obligations.

§ 11 Any proceeding, legal or equitable, under this Bond may be instituted in any court of competent jurisdiction in the location in which the work or part of the work is located and shall be instituted within two years after a declaration of Contractor Default or within two years after the Contractor ceased working or within two years after the Surety refuses or fails to perform its obligations under this Bond, whichever occurs first. If the provisions of this Paragraph are void or prohibited by law, the minimum period of limitation available to sureties as a defense in the jurisdiction of the suit shall be applicable.

§ 12 Notice to the Surety, the Owner or the Contractor shall be mailed or delivered to the address shown on the page on which their signature appears.

§ 13 When this Bond has been furnished to comply with a statutory or other legal requirement in the location where the construction was to be performed, any provision in this Bond conflicting with said statutory or legal requirement shall be deemed deleted herefrom and provisions conforming to such statutory or other legal requirement shall be deemed incorporated herein. When so furnished, the intent is that this Bond shall be construed as a statutory bond and not as a common law bond.

§ 14 Definitions

§ 14.1 **Balance of the Contract Price.** The total amount payable by the Owner to the Contractor under the Construction Contract after all proper adjustments have been made, including allowance to the Contractor of any amounts received or to be received by the Owner in settlement of insurance or other claims for damages to which the Contractor is entitled, reduced by all valid and proper payments made to or on behalf of the Contractor under the Construction Contract.

§ 14.2 **Construction Contract.** The agreement between the Owner and Contractor identified on the cover page, including all Contract Documents and changes made to the agreement and the Contract Documents.

§ 14.3 **Contractor Default.** Failure of the Contractor, which has not been remedied or waived, to perform or otherwise to comply with a material term of the Construction Contract.

§ 14.4 **Owner Default.** Failure of the Owner, which has not been remedied or waived, to pay the Contractor as required under the Construction Contract or to perform and complete or comply with the other material terms of the Construction Contract.

§ 14.5 **Contract Documents.** All the documents that comprise the agreement between the Owner and Contractor.

§ 15 If this Bond is issued for an agreement between a Contractor and subcontractor, the term Contractor in this Bond shall be deemed to be Subcontractor and the term Owner shall be deemed to be Contractor.

§ 16 Modifications to this bond are as follows:

Sample

(Space is provided below for additional signatures of added parties, other than those appearing on the cover page.)

CONTRACTOR AS PRINCIPAL

SURETY

Company: _____

(Corporate Seal)

Company: _____

(Corporate Seal)

Signature: _____
Name and Title: _____
Address _____

Signature: _____
Name and Title: _____
Address _____

CAUTION: You should sign an original AIA Contract Document, on which this text appears in RED. An original assures that changes will not be obscured.



AIA® Document A312™ – 2010

Payment Bond

CONTRACTOR:

(Name, legal status and address)

SURETY:

(Name, legal status and principal place of business)

OWNER:

(Name, legal status and address)

This document has important legal consequences. Consultation with an attorney is encouraged with respect to its completion or modification.

Any singular reference to Contractor, Surety, Owner or other party shall be considered plural where applicable.

AIA Document A312-2010 combines two separate bonds, a Performance Bond and a Payment Bond, into one form. This is not a single combined Performance and Payment Bond.

CONSTRUCTION CONTRACT

Date:

Amount:

Description:

(Name and location)

BOND

Date:

(Not earlier than Construction Contract Date)

Amount:

Modifications to this Bond: None See Section 18

CONTRACTOR AS PRINCIPAL

Company: *(Corporate Seal)*

SURETY

Company: *(Corporate Seal)*

Signature: _____

Name _____
and Title: _____

Signature: _____

Name _____
and Title: _____

(Any additional signatures appear on the last page of this Payment Bond.)

(FOR INFORMATION ONLY — Name, address and telephone)

AGENT or BROKER:**OWNER'S REPRESENTATIVE:**

(Architect, Engineer or other party:)

§ 1 The Contractor and Surety, jointly and severally, bind themselves, their heirs, executors, administrators, successors and assigns to the Owner to pay for labor, materials and equipment furnished for use in the performance of the Construction Contract, which is incorporated herein by reference, subject to the following terms.

§ 2 If the Contractor promptly makes payment of all sums due to Claimants, and defends, indemnifies and holds harmless the Owner from claims, demands, liens or suits by any person or entity seeking payment for labor, materials or equipment furnished for use in the performance of the Construction Contract, then the Surety and the Contractor shall have no obligation under this Bond.

§ 3 If there is no Owner Default under the Construction Contract, the Surety's obligation to the Owner under this Bond shall arise after the Owner has promptly notified the Contractor and the Surety (at the address described in Section 13) of claims, demands, liens or suits against the Owner or the Owner's property by any person or entity seeking payment for labor, materials or equipment furnished for use in the performance of the Construction Contract and tendered defense of such claims, demands, liens or suits to the Contractor and the Surety.

§ 4 When the Owner has satisfied the conditions in Section 3, the Surety shall promptly and at the Surety's expense defend, indemnify and hold harmless the Owner against a duly tendered claim, demand, lien or suit.

§ 5 The Surety's obligations to a Claimant under this Bond shall arise after the following:

§ 5.1 Claimants, who do not have a direct contract with the Contractor,

- .1 have furnished a written notice of non-payment to the Contractor, stating with substantial accuracy the amount claimed and the name of the party to whom the materials were, or equipment was, furnished or supplied or for whom the labor was done or performed, within ninety (90) days after having last performed labor or last furnished materials or equipment included in the Claim; and
- .2 have sent a Claim to the Surety (at the address described in Section 13).

§ 5.2 Claimants, who are employed by or have a direct contract with the Contractor, have sent a Claim to the Surety (at the address described in Section 13).

§ 6 If a notice of non-payment required by Section 5.1.1 is given by the Owner to the Contractor, that is sufficient to satisfy a Claimant's obligation to furnish a written notice of non-payment under Section 5.1.1.

§ 7 When a Claimant has satisfied the conditions of Sections 5.1 or 5.2, whichever is applicable, the Surety shall promptly and at the Surety's expense take the following actions:

§ 7.1 Send an answer to the Claimant, with a copy to the Owner, within sixty (60) days after receipt of the Claim, stating the amounts that are undisputed and the basis for challenging any amounts that are disputed; and

§ 7.2 Pay or arrange for payment of any undisputed amounts.

§ 7.3 The Surety's failure to discharge its obligations under Section 7.1 or Section 7.2 shall not be deemed to constitute a waiver of defenses the Surety or Contractor may have or acquire as to a Claim, except as to undisputed amounts for which the Surety and Claimant have reached agreement. If, however, the Surety fails to discharge its obligations under Section 7.1 or Section 7.2, the Surety shall indemnify the Claimant for the reasonable attorney's fees the Claimant incurs thereafter to recover any sums found to be due and owing to the Claimant.

§ 8 The Surety's total obligation shall not exceed the amount of this Bond, plus the amount of reasonable attorney's fees provided under Section 7.3, and the amount of this Bond shall be credited for any payments made in good faith by the Surety.

§ 9 Amounts owed by the Owner to the Contractor under the Construction Contract shall be used for the performance of the Construction Contract and to satisfy claims, if any, under any construction performance bond. By the Contractor furnishing and the Owner accepting this Bond, they agree that all funds earned by the Contractor in the performance of the Construction Contract are dedicated to satisfy obligations of the Contractor and Surety under this Bond, subject to the Owner's priority to use the funds for the completion of the work.

§ 10 The Surety shall not be liable to the Owner, Claimants or others for obligations of the Contractor that are unrelated to the Construction Contract. The Owner shall not be liable for the payment of any costs or expenses of any Claimant under this Bond, and shall have under this Bond no obligation to make payments to, or give notice on behalf of, Claimants or otherwise have any obligations to Claimants under this Bond.

§ 11 The Surety hereby waives notice of any change, including changes of time, to the Construction Contract or to related subcontracts, purchase orders and other obligations.

§ 12 No suit or action shall be commenced by a Claimant under this Bond other than in a court of competent jurisdiction in the state in which the project that is the subject of the Construction Contract is located or after the expiration of one year from the date (1) on which the Claimant sent a Claim to the Surety pursuant to Section 5.1.2 or 5.2, or (2) on which the last labor or service was performed by anyone or the last materials or equipment were furnished by anyone under the Construction Contract, whichever of (1) or (2) first occurs. If the provisions of this Paragraph are void or prohibited by law, the minimum period of limitation available to sureties as a defense in the jurisdiction of the suit shall be applicable.

§ 13 Notice and Claims to the Surety, the Owner or the Contractor shall be mailed or delivered to the address shown on the page on which their signature appears. Actual receipt of notice or Claims, however accomplished, shall be sufficient compliance as of the date received.

§ 14 When this Bond has been furnished to comply with a statutory or other legal requirement in the location where the construction was to be performed, any provision in this Bond conflicting with said statutory or legal requirement shall be deemed deleted herefrom and provisions conforming to such statutory or other legal requirement shall be deemed incorporated herein. When so furnished, the intent is that this Bond shall be construed as a statutory bond and not as a common law bond.

§ 15 Upon request by any person or entity appearing to be a potential beneficiary of this Bond, the Contractor and Owner shall promptly furnish a copy of this Bond or shall permit a copy to be made.

§ 16 Definitions

§ 16.1 Claim. A written statement by the Claimant including at a minimum:

- .1 the name of the Claimant;
- .2 the name of the person for whom the labor was done, or materials or equipment furnished;
- .3 a copy of the agreement or purchase order pursuant to which labor, materials or equipment was furnished for use in the performance of the Construction Contract;
- .4 a brief description of the labor, materials or equipment furnished;
- .5 the date on which the Claimant last performed labor or last furnished materials or equipment for use in the performance of the Construction Contract;
- .6 the total amount earned by the Claimant for labor, materials or equipment furnished as of the date of the Claim;
- .7 the total amount of previous payments received by the Claimant; and
- .8 the total amount due and unpaid to the Claimant for labor, materials or equipment furnished as of the date of the Claim.

§ 16.2 Claimant. An individual or entity having a direct contract with the Contractor or with a subcontractor of the Contractor to furnish labor, materials or equipment for use in the performance of the Construction Contract. The term Claimant also includes any individual or entity that has rightfully asserted a claim under an applicable mechanic's lien or similar statute against the real property upon which the Project is located. The intent of this Bond shall be to include without limitation in the terms "labor, materials or equipment" that part of water, gas, power, light, heat, oil, gasoline, telephone service or rental equipment used in the Construction Contract, architectural and engineering services required for performance of the work of the Contractor and the Contractor's subcontractors, and all other items for which a mechanic's lien may be asserted in the jurisdiction where the labor, materials or equipment were furnished.

§ 16.3 Construction Contract. The agreement between the Owner and Contractor identified on the cover page, including all Contract Documents and all changes made to the agreement and the Contract Documents.

§ 16.4 **Owner Default.** Failure of the Owner, which has not been remedied or waived, to pay the Contractor as required under the Construction Contract or to perform and complete or comply with the other material terms of the Construction Contract.

§ 16.5 **Contract Documents.** All the documents that comprise the agreement between the Owner and Contractor.

§ 17 If this Bond is issued for an agreement between a Contractor and subcontractor, the term Contractor in this Bond shall be deemed to be Subcontractor and the term Owner shall be deemed to be Contractor.

§ 18 Modifications to this bond are as follows:

(Space is provided below for additional signatures of added parties, other than those appearing on the cover page.)

CONTRACTOR AS PRINCIPAL

Company: _____

(Corporate Seal)

SURETY

Company: _____

(Corporate Seal)

Signature: _____

Name and Title: _____

Address _____

Signature: _____

Name and Title: _____

Address _____

CAUTION: You should sign an original AIA Contract Document, on which this text appears in RED. An original assures that changes will not be obscured.

EQUAL BENEFITS COMPLIANCE PAYMENT CERTIFICATION FORM

PURPOSE

25.13 of the Dane County Ordinance requires that each contractor receiving payment for contracted services must certify that he or she has complied fully with the requirements of Chapter 25.13 "Equal Benefits Requirement" of the Dane County Ordinances. Such certification must be submitted prior to the final payment on the contract.

This form should be included with a copy of the final contract invoice forwarded to your contract representative at Dane County.

CERTIFICATION

I, _____ certify that
Printed or Typed Name and Title

Printed or Typed Name of Contractor

has complied fully with the requirements of Chapter 25.13 of the Dane County Ordinances "Equal Benefits Requirements".

Signed _____

Date _____

For questions on this form, please contact Chuck Hicklin at 608-266-4109 or your contract representative at Dane County.

CONDITIONS OF CONTRACT

TABLE OF CONTENTS

1. BIDS AND QUOTATIONS	1
2. GUARANTEE AND BOND.....	2
3. SHOP DRAWINGS, PRODUCT DATA AND SAMPLES	3
4. AWARDS	4
5. CONTRACT PROVISIONS.....	5
6. GENERAL GUARANTEE.....	10
7. IDENTICAL BIDDING.....	10
8. BINDING CONTRACTS	10
9. AFFIRMATIVE ACTION PROVISION AND MINORITY / WOMEN / DISADVANTAGED BUSINESS ENTERPRISES	11
10. COMPLIANCE WITH FAIR LABOR STANDARDS	11
11. DOMESTIC PARTNERSHIP BENEFITS.....	12
12. INSURANCE REQUIREMENTS	12

1. BIDS AND QUOTATIONS

- A. **Addressing of Bids.** Bids shall be addressed to attention of Public Works Engineering Division and received at Dane County Department of Public Works, Highway & Transportation, 1919 Alliant Energy Center Way, Madison, WI 53713, on or before local time and date specified herein for Bid Due Date. Seal all bids in envelopes and clearly mark front with bid number and reference to specified contents of bid. All uses of term “County” in Construction Documents shall mean Dane County.
- B. **Only One Copy Required.** Unless otherwise specified, only one copy of bid or quotation on prescribed Bid Form will be required.
- C. **Additional Data with Bid.** Bidder may submit, on firm’s letterhead only, additional data and information deemed advantageous to County. County shall hold optional consideration of such data and information.
- D. **More than One Bid.** Bidders desiring to submit more than one bid may do so provided such additional bid or bids are properly submitted on Dane County Department of Public Works, Highway & Transportation’s Bid Form. Obtain extra sets of Construction Documents from Dane County Department of Public Works, Highway & Transportation. All uses of term “Department” in Construction Documents shall mean Department of Public Works, Highway & Transportation, which is Dane County government unit.
- E. **Withdrawal or Late Bids.** County will not accept formal bids, amendments thereto, or requests for withdrawal of bid or any part thereof, after time of Bid Due Date.
- F. **Preparation and Submission.** All written bids, unless otherwise provided for, must be submitted on and in accordance with forms provided by County properly signed in ink. Bids not signed by hand are not accepted. Bidders must register in advance with Purchasing Division.
- G. **Products by Name.** Intention of Specifications of products by name is to be descriptive of quality, workmanship, finish, function and approximate characteristics desired; intention is not necessarily restriction. Consideration of products substitution for those named is possible, provided substitute offered is, in opinion of Dane County Public Works Project

Manager, equal or superior in quality, workmanship, finish, function and approximate characteristics to that specified in Project Manual Specifications listed herein.

- H. **Visitation of Sites.** Bidder shall visit site(s) that will receive intended work or installation, and in so doing, be held responsible for job deemed satisfactory by County after completion of the Work or installation. No additional compensation shall be allowed for any condition of which bidder could have been informed.
- I. **Completeness.** Supply all information required by Construction Documents to constitute regular bid. This shall include:
 - 1. Completed Bid Form.
 - 2. Completed Fair Labor Practices Certification.
 - 3. Completed Bid Bond.
- J. **Bids Binding Sixty (60) Calendar Days.** Unless otherwise specified all formal bids submitted shall be binding for sixty (60) calendar days following Bid Due Date.
- K. **Conditional Bids.** Qualified bids are subject to complete rejection, or partial rejection.
- L. **All or Part.** Bids or quotations may be considered and award made for all or any part of total quantities as specified in Construction Documents.
- M. **Errors.** Unit bid price shall govern when extending total prices has errors. Carelessness in quoting prices or in preparation of bid otherwise, will not relieve bidder. Explain all erasures in bids and include signature of bidder.
- N. **Regulation by State Statutes.** Bidding and letting of contracts are subject to provisions of Wisconsin Statutes 59.52(29) and 66.0901 and all subsequent sections and amendments thereof.
- O. **Bidders Present.** Bid Due Date is time fixed for opening of formal bids. Bids' contents will be made public for information of bidders and others properly interested, who may be present either in person or by representative. Bidders are encouraged to attend all openings, and to offer constructive suggestions for improvements to bid format or ways in which County can realize greater savings.
- P. **Taxes.** Contractor shall pay applicable State and local sales taxes.

2. GUARANTEE AND BOND

- A. **Bid Bond / Guarantee.** Bid Bond shall accompany Bids, which shall be either flat sum or percentage figure as shown on Project Manual Cover. This Bid Bond shall serve as warrant that successful bidder will fulfill terms of bid within time limit as indicated in bid after notice of award by Dane County. Bid Bond may be certified bank check (note: uncertified checks will not be acceptable), cashier's check or United State money order payable to Treasurer of Dane County; or on Bid Bond with corporate surety authorized to do business in State of Wisconsin and warranty of attorney to confess judgment thereon attached thereto. County will return negotiable Bid Bonds to unsuccessful bidders after awarding of bid. County shall return check held from Contractor after satisfactory completion of Contract or

after receipt by County of Performance Bond from Contractor, if one is required. Surety Bid Bonds will not be returned unless specifically requested by individual bidders.

- B. **Guarantor Liability.** When guarantee is required, failure of bidder to furnish acceptable Performance Bond (Article 2.C.) within twenty (20) business days after receipt of notice of award shall render guarantor liable to County. Bids covered by certified check or bond such security shall become absolute property of County and shall be deposited with County Treasurer for benefit of County as liquidated damages. County shall forthwith proceed to collect on Bid Bond.
- C. **Performance / Payment Bond.** When required, file guarantee that successful bidder will faithfully perform obligations of bid as accepted. Such guarantee must be bond complying with Wisconsin Statute 779.14 with corporate surety authorized to do business in this State, and that Contractor or subcontractors will be responsible for all claims for injuries to persons or damages to property or premises arising out of or in connection with their operations prior to acceptance of finished work or supplies, and that they will promptly make payments to all persons supplying them with labor or materials in execution of the Work provided for in Contract; guarantee to indemnify, hold harmless and defend Dane County, its boards, commissions, agencies, officers, employees and representatives from all costs, damages and expenses growing out of or by reason of successful bidder's failure to comply and perform the Work and complete Contract in accordance with Construction Documents; attach thereto a warrant of attorney authorizing confession of judgment thereon for benefit of County.

3. SHOP DRAWINGS, PRODUCT DATA AND SAMPLES

- A. Shop Drawings are drawings, diagrams, schedules and other data specially prepared for the Work by Contractor or subcontractor, sub-subcontractor, manufacturer, supplier or distributor to illustrate some portion of the Work.
- B. Product Data are illustrations, standard schedules, performance charts, instructions, brochures, diagrams and other information furnished by Contractor to illustrate materials or equipment for some portion of the Work.
- C. Samples are physical examples that illustrate materials, equipment or workmanship and establish standards to compare the Work.
- D. Shop Drawings, Product Data, Samples and similar submittals are not Construction Documents. Purpose of their submittal is to demonstrate for those portions of the Work for which submittals are required how Contractor proposes to conform to information given and design concept expressed in Construction Documents.
- E. Contractor shall review, approve and submit to Public Works Project Manager Shop Drawings, Product Data, Samples and similar submittals required by Construction Documents with reasonable promptness and in such sequence as to cause no delay in the Work or in activities of County or of separate contractors. Submittals made by Contractor not required by Construction Documents, may be returned without action.
- F. Contractor shall perform no portion of the Work requiring submittal and review of Shop Drawings, Product Data, Samples or similar submittals until Public Works Project Manager has approved respective submittal. Such Work shall be in accordance with approved submittals.

- G. By approving and submitting, Shop Drawings, Product Data, Samples and similar submittals, Contractor represents that Contractor has determined and verified materials, field measurements and field construction criteria related thereto, or will do so, and has checked and coordinated information contained within such submittals with requirements of the Work and of Construction Documents.
- H. Contractor shall not be relieved of responsibility for deviations from requirements of Construction Documents by Public Works Project Manager's approval of Shop Drawings, Product Data, Samples and similar submittals unless Contractor has specifically informed Public Works Project Manager in writing of such deviation at time of submittal and Public Works Project Manager has given written approval to specific deviation. Contractor shall not be relieved of responsibility for errors or omissions in Shop Drawings, Product Data, Sample or similar submittals by Public Works Project Manager's approval thereof.
- I. Contractor shall in writing direct specific attention to revised and / or resubmitted Shop Drawings, Product Data, Samples or similar submittals that were not requested by Public Works Project Manager on previous submittals.
- J. Unless specified otherwise, Contractor shall submit three (3) copies of all Shop Drawings, Product Data, Samples or similar submittals for each submission, until receiving final approval. After final approval, provide five (5) additional copies for distribution and such other copies as may be required.

4. AWARDS

- A. **Lowest Responsible Bidder.** Award will be to lowest responsible bidder conforming to Construction Documents or on most advantageous bid to County.
- B. **Other Considerations.** Quantities involved, time of delivery, purpose for which required, competency of bidder, ability to render satisfactory service and past performance will be considered in determining responsibility.
- C. **Rejection of Bids.** County reserves right to reject any or all bids or quotations in whole or in part and to award by items, parts of items, or by any aggregate group of items specified. County also reserves right to waive technical defects when in its judgment best interests of County thereby will be served.
- D. **Notice of Acceptance.** Sufficient notification of acceptance of bid will be written notice of award to bidder in form of Purchase Order or similar, mailed or delivered to address shown on Bid Form.
- E. **Tie Bids.** If two or more bidders submit identical bids, decision of County to make award to one or more of such bidders shall be final. Cash discount will be taken into consideration in determining award. Also, see Article 7.A. IDENTICAL BIDDING, Antitrust Laws.
- F. **Qualifying Bidders.** Prior to solicitation and / or awarding of bid, County may require submission by bidder of complete financial statement and questionnaire describing bidder's financial ability and experience in performance of similar work. Refer to Instructions to Bidders.

- G. **Disqualification.** Awards will not be made to any person, firm or company in default of Contract with County, or to any bidder having as its sales agent or representative or as member of firm, any individual previously in default or guilty of misrepresentation.
- H. **Bid Results.** Bidders may secure information pertaining to results of bids by visiting Public Works' website, bids-pwht.countyofdane.com/.

5. CONTRACT PROVISIONS

- A. **Acceptance Constitutes Contract.** Written acceptance by Public Works Project Manager of proposal for services shall constitute Contract, which shall bind bidder to perform the Work as detailed in Construction Documents, for bid amount and in accordance with all conditions of said accepted bid. Formal Contract containing all provisions of Contract signed by both parties shall be used when required by Public Works Project Manager.
- B. **Local Restrictions and Permits.** All work shall be done according to applicable laws, ordinances and codes. Contractor shall procure and pay for all required permits for permanent or temporary work.
- C. **Payment of Invoices.** Payment may be made only after inspection and acceptance by using agency and approval by Dane County Public Works Project Manager, and, where required by ordinances, approval by Dane County Board of Supervisors. If materials or equipment were delivered, constructed, erected, installed or tested on site, payment shall be made based on ninety-five percent (95%) of value of all the Work performed up to fifty percent (50%) of scheduled values less total of previous payments. Authorized extra work will be included in progress payments. Payment of balances will be made only after approval and final acceptance by County in consideration and elimination of possibilities of imperfect work, faulty materials or equipment, liens that have been filed, or if evidence indicates possible filing of claims.
- D. **Contract Alterations.** No alterations or variables in terms of contract shall be valid or binding upon County unless made in writing and signed by Purchasing Agent or authorized agent.
- E. **Assignments.** No contract may be assigned, sublet or transferred without written consent of Public Works Project Manager.
- F. **Cancellations.** Contract may be canceled or voided by Public Works Project Manager upon non-performance or violation of contract provisions, and award made to next low bidder or articles specified may be purchased on open market. In either event, defaulting contractor (or their surety) shall be liable to Dane County for costs to County in excess of defaulting contractor's contract prices.
- G. **Right of Department to Terminate Contract.**
 - 1. In event that Contractor or any subcontractors violate any provisions of this Contract, County may serve written notice upon Contractor and Surety of its intention to terminate Contract. Such notice to contain reasons for such intention to terminate Contract, and unless within ten (10) business days after serving of such notice upon Contractor, such violation or delay shall cease and satisfactory arrangement or correction be made, Contract shall, upon expiration of said ten (10) business days, cease and terminate.

2. In event of any such termination, County shall immediately serve notice thereof upon Surety and Contractor, and Surety shall have right to take over and perform Contract subject to County's approval. However, if Surety does not commence performance thereof within ten (10) business days from date of mailing to such Surety of notice of termination, County may take over the Work and prosecute same to completion by Contract or by force account for account and at expense of Contractor. Contractor and Surety shall be liable to County for any excess cost occasioned County thereby, and in such event County may take possession of and utilize in completing the Work, such equipment, materials and / or supplies as may be on site of the Work and therefore necessary.
- H. **Non-Liability.** Contractor shall not be liable in damages for delay in shipment or failure to deliver when such delay or failure is result of fire, flood, strike, transporting carrier, act of God, act of government, act of alien enemy or by any other circumstances which, in Public Works Project Manager's opinion, is beyond control of Contractor. Under such circumstances, however, Public Works Project Manager may in discretion, cancel Contract.
- I. **Quality Assurance.** Inspection of equipment, materials and / or supplies shall be made by or at direction of County or Agency to which goods are delivered, and any articles supplied that are defective, or fails in any way to meet Specifications or other requirements of Contract, will be rejected. Public Works Project Manager shall direct all required laboratory tests. Decision of Public Works Project Manager on acceptance shall be final.
- J. **Time for Completion.** Contractor agrees that the Work shall be prosecuted regularly and diligently and complete entire project as stated in Construction Documents.
- K. **Changes in the Work.**
1. Except in cases of emergency, no changes in the Work covered by approved Construction Documents shall be made without having prior written approval of Department. Charges or credits for work covered by approved change shall be determined by one of these methods:
 - a) Unit bid prices previously approved.
 - b) Agreed lump sum based on actual cost of:
 - 1) Labor, including foremen, and all fringe benefits that are associated with their wages;
 - 2) Materials entering permanently into the Work;
 - 3) Ownership or rental cost of construction plant and equipment during time of use on extra work;
 - 4) Power and consumable supplies for operation of construction or power equipment;
 - 5) Workmen's Compensation Insurance, Contractor's Public Liability and Property Damage Insurance, and Comprehensive Automobile Liability Insurance;
 - 6) Social Security, pension and unemployment contributions;
 - 7) To cost under K.1.b), there shall be added fixed fee to be agreed upon, but not to exceed fifteen percent (15%) of actual cost of the Work performed with their own labor force; fee shall be compensation to cover cost of supervision, overhead, bond, profit and any other general expense;
 - 8) On that portion of work under K.1.b) done under subcontract, Contractor may include not over seven and one-half percent (7½%) for supervision, overhead, bond, profit and any other general expense; and
 - 9) Contractor shall keep and present in such form as directed, correct amount of cost together with such supporting vouchers as may be required by Department.

- c) Cost-Plus Work, with not-to-exceed dollar limit, based on actual cost of:
 - 1) Labor, including foremen, and all fringe benefits that are associated with their wages;
 - 2) Materials entering permanently into the Work;
 - 3) Ownership or rental cost of construction plant and equipment during time of use on extra work. (Rental cost cannot exceed fifty percent (50%) replacement value of rented equipment);
 - 4) Power and consumable supplies for operation of construction or power equipment;
 - 5) Workmen's Compensation, Contractor's Public Liability and Property Damage Insurance, and Comprehensive Automobile Liability Insurance;
 - 6) Social Security, pension and unemployment contributions;
 - 7) To cost under K.1.c) there shall be added fixed fee to be agreed upon, but not to exceed fifteen percent (15%) of actual cost of the Work performed with their own labor force; fee shall be compensation to cover cost of supervision, overhead, bond, profit, and any other general expense;
 - 8) On that portion of work under K.1.c) done under subcontract, Contractor may include not over seven and one-half percent (7½%) for supervision, overhead, bond, profit, and any other general expense; and
 - 9) Contractor shall keep and present in such form as directed, correct amount of cost together with such supporting vouchers as may be required by Department.
 2. If Contractor claims that by any instructions given by Public Works Project Manager, Department, by drawings or otherwise, regarding performance of the Work or furnishing of material under Contract, involves extra cost, Contractor shall give Department written notice thereof within two weeks after receipt of such instructions and in any event before proceeding to execute work, unless delay in executing work would endanger life or property.
 3. No claim for extra work or cost shall be allowed unless same was done in pursuance of written order of Public Works Project Manager, Department, as previously mentioned, and claim presented with payment request submitted after changed or extra work is completed.
 4. Negotiation of cost for change in the Work shall not be cause for Contractor to delay prosecution of the Work if Contractor has been authorized in writing by Public Works Project Manager to proceed.
- L. Payments to Contractor.**
1. County will make partial payments to Contractor for value, proportionate to amount of Contract, of all labor and material incorporated in the Work during preceding calendar month upon receipt of approved Application and Certificate of Payment from Department.
 2. Contractor shall submit to Public Works Project Manager Application and Certificate of Payment. Public Works Project Manager will review and approve this. Evidence may be required, and supplied on demand, that supports request and Contractor's right to payment claimed.
 3. Request for payment for preparatory work and materials delivered and suitably stored at site to be incorporated into the Work at some future period, will be given due consideration. Requests involving materials stored off site, may be rejected; however, if

- deemed essential for reasons of job progress, protection, or other sufficient cause, requests will be considered conditional upon submission by Contractor of bills of sale and such other procedures as will adequately protect County's interest such as storage in bonded warehouse with adequate coverage. If there is any error in payment, Contractor is obligated to notify Department immediately, but no longer than ten (10) business days from receipt of payment.
4. Payments by County will be due within forty-five (45) business days after receipt by Department of certified request.
 5. Five percent (5%) of each request for certification will be retained until final completion and acceptance of all the Work covered by Contract. However, anytime after fifty percent (50%) of the Work has been furnished and installed at site, remaining payments will be made in full if Public Works Project Manager find that progress of the Work corresponds with construction progress schedule. If Public Works Project Manager find that progress of the Work does not correspond with construction progress schedule, up to ten percent (10%) of each request for payment may be retained for the Work completed.
 6. All material and work covered by partial payments made shall become sole property of County. This provision shall not be construed as relieving Contractor from sole responsibility for care and protection of materials and work upon which payments have been made or restoration of any damaged work, or as waiver of right of County to require fulfillment of all of terms of Contract.
 7. Final payment will be made within sixty (60) calendar days after final completion of the Work, and will constitute acceptance thereof. Submit Equal Benefits Compliance Payment Certification with final pay request. Payment may be denied if Certification is not included.
 8. On completion and acceptance of each separate division of Contract, on which stated price is separated in Contract, payment may be made in full, including retained percentages thereon, less authorized deductions.
 9. Every contractor engaged in performance of any contract for Department of Public Works, Highway & Transportation shall submit to this Department, as requested and with final application for payment for work under said contract, affidavit(s) as required to prove that all debts and claims against this Work are paid in full or otherwise satisfied, and give final evidence of release of all liens against the Work and County. If Wisconsin Prevailing Wage Rate Determination is required for this Work, use "Prime Contractor Affidavit of Compliance With Prevailing Wage Rate Determination" and "Agent or Subcontractor Affidavit of Compliance With Prevailing Wage Rate Determination" (if applicable). If Wisconsin Prevailing Wage Rate Determination is not required for this Work, use "Dane County, Wisconsin Contractor Wage Affidavit". Forms of such affidavits are included in Supplementary Conditions.

M. Withholding of Payments.

1. County, after having served written notice on said Contractor, may either pay directly any unpaid bills of which Department has written notice, or withhold from Contractor's unpaid compensation, sum of money deemed reasonably sufficient to pay any and all such lawful claims until satisfactory evidence is furnished that all liabilities have been fully discharged. Then payment to Contractor shall be resumed in accordance with terms

of this Contract, but in no event shall these provisions be construed to impose any obligations upon County to either Contractor or Contractor's Surety.

2. In paying any unpaid bills of Contractor, County shall be deemed Agent of Contractor, and any payment so made by County, shall be considered as payment made under Contract by County to Contractor and County shall not be liable to Contractor for any such payment made in good faith.
3. Contractor shall indemnify, hold harmless and defend Dane County, its boards, commissions, agencies, officers, employees and representatives from all claims growing out of lawful demands of subcontractors, laborers, workmen, mechanics, material men, and furnishers of machinery and parts thereof, equipment, power tools, and all supplies, including commissary, incurred in performance of this Contract.
4. At Department's request, Contractor shall furnish satisfactory evidence that all obligations of nature designated above have been paid, discharged or waived.

N. Acceptance of Final Payment as Release.

1. Making of final payment shall constitute waiver of all claims by County except those arising from:
 - a) Unsettled lien;
 - b) Faulty or defective work appearing after substantial completion;
 - c) Failure of the Work to comply with requirements of Construction Documents; or
 - d) Terms of any special guarantees required by Construction Documents.
2. Acceptance of final payment shall constitute waiver of all claims by Contractor.

O. Lien Waivers. Contractor warrants that title to all work covered by application for Payment will pass to County no later than time of payment. Contractor further warrants that upon submittal of Application for Payment all work for which Certificates for Payment have been previously issued and payments received from County shall, to best of Contractor's knowledge, information and belief, be free and clear of liens, claims, security interests or encumbrances in favor of Contractor, subcontractor, material suppliers, or other persons or entities making claim by reason of having provide labor, materials and equipment related to the Work.

P. Use and Occupancy Prior to Acceptance. Contractor agrees to use and occupancy of portion or unit of project before formal acceptance by Department, provided Department:

1. Secures written consent of Contractor; except when in opinion of Department's Public Works Project Manager, Contractor is chargeable with unwarranted delay in final cleanup of punch list items or other Contract requirements;
2. Secures endorsement from insurance carrier and consent of Surety permitting occupancy of building or use of project during remaining period of construction, or, secures consent of Surety;
3. Assumes all costs and maintenance of heat, electricity and water; and
4. Accepts all work completed within that portion or unit of project to be occupied, at time of occupancy.

Q. Correction of Work.

1. All work, all materials whether incorporated in the Work or not, and all processes of manufacture shall at all times and places be subject to inspection of Public Works Project Manager who shall be judge of quality and suitability of work, materials, and

processes of manufacture for purposes for which they are used. Should they fail to meet Public Works Project Manager's approval they shall be reconstructed, made good, replaced or corrected, as case may be, by Contractor at Contractor's expense. Rejected material shall immediately be removed from site.

2. If Contractor defaults or neglects to carry out the Work in accordance with Construction Documents or fails to perform any provision of Contract, Department may, after ten (10) business days written notice to Contractor and without prejudice to any other remedy County may have, make good such deficiencies. In such case, appropriate Change Order shall be issued deducting from payments then or thereafter due Contractor cost of correcting such deficiencies, including cost of Public Works Project Manager's additional services made necessary by such default, neglect or failure.

6. GENERAL GUARANTEE

- A. Neither final certificate of payment nor any provision in Construction Documents nor partial or entire occupancy of premises by County shall constitute acceptance of work not done in accordance with Construction Documents or relieve Contractor of liability in respect to any expressed warranties or responsibility for faulty materials or workmanship.
 1. In no event shall making of any payment required by Contract constitute or be construed as waiver by County of any breach of covenants of Contract or waiver of any default of Contractor and making of any such payment by County while any such default or breach shall exist shall in no way impair or prejudice right of County with respect to recovery of damages or other remedy as result of such breach or default.
- B. Contractor shall remedy and make good all defective workmanship and materials and pay for any damage to other work resulting therefrom, which appear within period of one year from date of substantial completion, providing such defects are not clearly due to abuse or misuse by County. Department will give notice of observed defects with reasonable promptness.
- C. Guarantee on work executed after certified date of substantial completion will begin on date when such work is inspected and approved by Public Works Project Manager.
- D. Where guarantees or warranties are required in sections of Construction Documents for periods in excess of one year, such longer terms shall apply; however, Contractor's Performance / Payment Bond shall not apply to any guarantee or warranty period in excess of one year.

7. IDENTICAL BIDDING

- A. **Antitrust Laws.** All identical bids submitted to County because of advertised procurement for materials, supplies, equipment or services exceeding \$1,000,000.00 in total amount shall be reported to Attorney Generals of the United States and State of Wisconsin for possible violation and enforcement of antitrust laws.

8. BINDING CONTRACTS

- A. **Contract Commitment.** Any contracts resulting from this bid shall be binding on successful bidder(s) to its conclusion and on its assigns, heirs, executors, administrators or successors.

9. AFFIRMATIVE ACTION PROVISION AND MINORITY / WOMEN / DISADVANTAGED BUSINESS ENTERPRISES

- A. **Affirmative Action Provisions.** During term of its Contract, Contractor agrees not to discriminate on basis of race, religion, color, sex, handicap, age, sexual preference, marital status, physical appearance, or national origin against any person, whether recipient of services (actual or potential), employee, or applicant for employment. Such equal opportunity shall include, but not be limited to following: employment, upgrading, demotion, transfer, recruitment, advertising, layoff, termination, training, rates of pay, and any other form of compensation or level of service(s). Contractor agrees to post in conspicuous places, available to all employees, service recipients and applicants for this paragraph. Listing of prohibited bases for discrimination shall no be construed to amend in any fashion state or federal law setting forth additional bases and exceptions shall be permitted only to extent allowable in state or federal law.
- B. Contractor is subject to this paragraph only if Contractor has ten (10) or more employees and receives \$10,000.00 or more in annual aggregate contracts with County. Contractor shall file Affirmative Action Plan with Dane County Contract Compliance Officer in accord with Chapter 19 of Dane County Code of Ordinances. Contractor must file such plan within fifteen (15) business days of effective date of this Contract and failure to do so by that date shall constitute grounds for immediate termination of Contract. During term of this Contract, Contractor shall also provide copies of all announcements of employment opportunities to County's Contract Compliance Office, and shall report annually number of persons, by race, sex and handicap status, which apply for employment and, similarly classified, number hired and number rejected.
- C. Contact Dane County Contract Compliance Officer at Dane County Contract Compliance Office, 210 Martin Luther King, Jr. Blvd., Room 421, Madison, WI 53703, 608/266-4114.
- D. In all solicitations for employment placed on Contractor's behalf during term of this Contract, Contractor shall include statement to effect that Contractor is "Equal Opportunity Employer."
- E. Contractor agrees to furnish all information and reports required by County's Contract Compliance Officer as same relate to affirmative action and nondiscrimination, which may include any books, records, or accounts deemed appropriate to determine compliance with Chapter 19, Dane County Code of Ordinances, and provision of this Contract.
- F. **Minority / Women / Disadvantaged / Emerging Small Business Enterprises.** Chapter 19.508 of Dane County Code of Ordinances is official policy of Dane County to utilize Minority Business Enterprises (MBEs), Women Business Enterprises (WBEs), Disadvantage Business Enterprises (DBEs) and Emerging Small Business Enterprises (ESBEs) fully.
- G. Contractor may utilize MBEs / WBEs / DBEs / ESBEs as subcontractors or suppliers. List of subcontractors will be required of low bidder as stated in this Contract. List shall indicate which subcontractors or suppliers are MBEs / WBEs / DBEs / ESBEs and what percentage of subcontract is awarded, shown as percentage of total dollar amount of bid.

10. COMPLIANCE WITH FAIR LABOR STANDARDS

- A. During term of this Contract, Contractor shall report to County Contract Compliance Officer, within ten (10) business days, any allegations to, or findings by National Labor Relations

Board (NLRB) or Wisconsin Employment Relations Commission (WERC) that Contractor has violated statute or regulation regarding labor standards or relations. If investigation by Contract Compliance Officer results in final determination that matter adversely affects Contractor's responsibilities under this Contract, and which recommends termination, suspension or cancellation of this Contract, County may take such action.

- B. Contractor may appeal any adverse finding by Contract Compliance Officer as set forth in Dane County Ordinance 25.015(11)(c) through (e).
- C. Contractor shall post this statement in prominent place visible to employees: "As condition of receiving and maintaining contract with Dane County, this employer shall comply with federal, state and all other applicable laws prohibiting retaliation or union organizing."

11. DOMESTIC PARTNERSHIP BENEFITS

- A. Contractor agrees to provide same economic benefits to all of its employees with domestic partners as it does to employees with spouses, or cash equivalent if such benefit cannot reasonably be provided. Contractor agrees to make available for County inspection Contractor's payroll records relating to employees providing services on or under this Contract or subcontract. If any payroll records of Contractor contain any false, misleading or fraudulent information, or if Contractor fails to comply with provisions of Chapter 25.13, Dane County Ordinances, contract compliance officer may withhold payments on Contract; terminate, cancel or suspend Contract in whole or in part; or, after due process hearing, deny Contractor right to participate in bidding on future County contracts for period of one year after first violation is found and for period of three years after second or subsequent violation is found.

12. INSURANCE REQUIREMENTS

- A. Contractor shall indemnify, hold harmless and defend Dane County, its boards, commissions, agencies, officers, employees and representatives from and against all claims, damages, losses and expenses including attorneys' fees arising out of or resulting from performance of the Work, provided that any such claim, damage, loss or expense is attributable to bodily injury, sickness, disease or death, or to injury to or destruction of tangible property (other than the Work itself) including loss of use resulting there from, and is caused in whole or in part by any act or omission of Contractor, any subcontractor, anyone directly or indirectly employed by any of them or anyone for whose acts any of them may be liable, regardless of whether or not it is caused in part by a part indemnified hereunder.
- B. In any and all claims against Dane County, its boards, commissions, agencies, officers, employees and representatives or by any employee of Contractor, any subcontractor, anyone directly or indirectly employed by any of them or anyone for whose acts any of them may be liable, indemnification obligation under this Contract shall not be limited in any way by any limitation on amount or type of damages, compensation or benefits payable by or for Contractor or any subcontractor under worker's compensation acts, disability benefits or other employee benefit acts.
- C. Obligations of Contractor under this Contract shall not extend to liability of Architect / Engineer, its agents or employees arising out of (1) preparation or approval of maps, drawings, opinion, reports, surveys, change orders, designs or specifications; or (2) giving of

or failure to give directions or instruction by Architect / Engineer, its agents or employees provided such giving or failure to give is primary cause of injury or damage.

- D. County shall not be liable to Contractor for damages or delays resulting from work by third parties or by injunctions or other restraining orders obtained by third parties.
- E. **Contractor Carried Insurance.** In order to protect itself and County, Contractor shall not commence work under this Contract until obtaining all required insurance and County has approved such insurance. Contractor shall not allow any subcontractor to commence work on subcontract until insurance required of subcontractor has been so obtained and approved.
1. **Worker's Compensation Insurance**
Contractor shall procure and shall maintain during life of this Contract, Worker's Compensation Insurance as required by statute for all of its employees engaged in work at site of project under this Contract and, in case of such work sublet, Contractor shall require subcontractor similarly to provide Worker's Compensation Insurance for all of latter's employees to be engaged in such work unless such employees are covered by protection afforded by Contractor's Worker's Compensation Insurance.
 2. **Contractor's Public Liability and Property Damage Insurance**
Contractor shall procure and maintain during life of this Contract, Contractor's Public Liability Insurance and Contractor's Property Damage Insurance in amount not less than \$1,000,000.00 per occurrence for bodily injury and death, and Contractor's Property Damage Insurance in amount not less than \$1,000,000.00 and shall be primary with Dane County as "Additional Insured".
 3. **Auto Liability Insurance**
Contractor shall procure and maintain during life of this Contract, Comprehensive Automobile Liability Insurance covering owned, non-owned and hired automobiles for limits of not less than \$1,000,000.00 and shall be primary with Dane County as "Additional Insured".
- F. Contractor either (1) shall require each subcontractors to procure and to maintain during life of subcontract, subcontractor's Public Liability Property Damage Insurance, and Comprehensive Automobile Liability Insurance of type and in same amount specified in preceding paragraphs; or (2) insure that activities of subcontractors in their own policy.
- G. Contractor shall furnish County with certificates showing type, amount, class of operations covered, effective dates and dates of expiration of policies. Such certificates shall also contain substantially this statement: "Insurance covered by this certificate will not be canceled or materially altered, except after ten (10) business days written notice has been received by County."
- H. **Builder's Risk.** County shall provide Builder's Risk insurance coverage for its insurable interests in construction or renovation projects with completed value of \$500,000 or less. Therefore, if project completed value is more than \$500,000, Contractor shall obtain and maintain in force, at its own expense, Builder's Risk Insurance on all risks for amount equal to full completed value of covered structure or replacement value of alterations or additions. Any deductible shall not exceed \$25,000 for each loss. Policy shall include occupancy clause and list Dane County as loss payee.

SUPPLEMENTARY CONDITIONS

1. APPLICATION & CERTIFICATE FOR PAYMENT

- A. Every contractor engaged in performance of any contract for Department of Public Works, Highway & Transportation shall submit partial and final Application & Certificate for Payment for work under said contract. Form shall provide similar information as shown on AIA G702™ and G703™ forms (samples shown below). Forms shall be submitted to Public Works Project Manager for approval.

AIA Document G702™ – 1992

Application and Certificate for Payment

TO OWNER:	PROJECT:	APPLICATION NO:	Distribution to:
FROM CONTRACTOR:	VIA ARCHITECT:	PERIOD TO:	OWNER <input type="checkbox"/>
		CONTRACT FOR:	ARCHITECT <input type="checkbox"/>
		CONTRACT DATE:	CONTRACTOR <input type="checkbox"/>
		PROJECT NOS:	FIELD <input type="checkbox"/>
			OTHER <input type="checkbox"/>

CONTRACTOR'S APPLICATION FOR PAYMENT

Application is made for payment, as shown below, in connection with the Contract. AIA Document G703™, Continuation Sheet, is attached.

1. ORIGINAL CONTRACT SUM \$ _____

2. NET CHANGE BY CHANGE ORDERS \$ _____

3. CONTRACT SUM TO DATE (Line 1 + 2) \$ _____

4. TOTAL COMPLETED & STORED TO DATE (Column G on G703) \$ _____

5. RETAINAGE:

a. _____ % of Completed Work
(Columns D + E on G703) \$ _____

b. _____ % of Stored Material
(Column F on G703) \$ _____

Total Retainage (Lines 5a + 5b, or Total in Column I of G703) \$ _____

6. TOTAL EARNED LESS RETAINAGE \$ _____
(Line 4 minus Line 5 Total)

7. LESS PREVIOUS CERTIFICATES FOR PAYMENT \$ _____
(Line 6 from prior Certificate)

8. CURRENT PAYMENT DUE \$ _____

9. BALANCE TO FINISH, INCLUDING RETAINAGE \$ _____
(Line 3 minus Line 6)

CHANGE ORDER SUMMARY	ADDITIONS	DEDUCTIONS
Total changes approved in previous months by Owner	\$ _____	\$ _____
Total approved this month	\$ _____	\$ _____
TOTAL	\$ _____	\$ _____
NET CHANGES by Change Order	\$ _____	\$ _____

The undersigned Contractor certifies that to the best of the Contractor's knowledge, information and belief the Work covered by this Application for Payment has been completed in accordance with the Contract Documents, that all amounts have been paid by the Contractor for Work for which previous Certificates for Payment were issued and payments received from the Owner, and that current payment shown herein is now due.

CONTRACTOR:
By: _____ Date: _____
State of: _____
County of: _____
Subscribed and sworn to before me this _____ day of _____

Notary Public:
My commission expires: _____

ARCHITECT'S CERTIFICATE FOR PAYMENT

In accordance with the Contract Documents, based on on-site observations and the data comprising this application, the Architect certifies to the Owner that to the best of the Architect's knowledge, information and belief the Work has progressed as indicated, the quality of the Work is in accordance with the Contract Documents, and the Contractor is entitled to payment of the AMOUNT CERTIFIED.

AMOUNT CERTIFIED \$ _____
(Attach explanation if amount certified differs from the amount applied. Initial all figures on this Application and on the Continuation Sheet that are changed to conform with the amount certified.)

ARCHITECT:
By: _____ Date: _____

This Certificate is not negotiable. The AMOUNT CERTIFIED is payable only to the Contractor named herein. Issuance, payment and acceptance of payment are without prejudice to any rights of the Owner or Contractor under this Contract.

CAUTION: You should sign an original AIA Contract Document, on which this text appears in RED. An original assures that changes will not be obscured.
 AIA Document G702™ – 1992, Copyright © 1963, 1963, 1965, 1971, 1978, 1983 and 1992 by The American Institute of Architects. All rights reserved. WARNING: This AIA® Document is protected by U.S. Copyright Law and International Treaties. Unauthorized reproduction or distribution of this AIA® Document, or any portion of it, may result in severe civil and criminal penalties, and will be prosecuted to the maximum extent possible under the law. Purchasers are permitted to reproduce ten (10) copies of this document when completed. To report copyright violations of AIA Contract Documents, e-mail The American Institute of Architects' legal counsel, copyright@aia.org.

Continuation Sheet

AIA Document G702™-1992, Application and Certificate for Payment, or G732™-2009, Application and Certificate for Payment, Construction Manager as Adviser Edition, containing Contractor's signed certification is attached. In tabulations below, amounts are in US dollars. Use Column I on Contracts where variable retainage for line items may apply.

APPLICATION NO:
APPLICATION DATE:
PERIOD TO:
ARCHITECT'S PROJECT NO:

A ITEM NO.	B DESCRIPTION OF WORK	C SCHEDULED VALUE	D WORK COMPLETED		F MATERIALS PRESENTLY STORED <i>(Not in D or E)</i>	G TOTAL COMPLETED AND STORED TO DATE <i>(D+E-F)</i>	H BALANCE TO FINISH <i>(C-G)</i>	I RETAINAGE <i>(if variable rate)</i>
			FROM PREVIOUS APPLICATION <i>(D-E)</i>	THIS PERIOD				
<p>CAUTION: You should sign an original AIA Contract Document, on which this text appears in RED. An original assures that changes will not be obscured.</p> <p>AIA Document G703™ – 1992. Copyright © 1963, 1965, 1966, 1967, 1970, 1978, 1983 and 1992 by The American Institute of Architects. All rights reserved. WARNING: This AIA® Document is protected by U.S. Copyright Law and International Treaties. Unauthorized reproduction or distribution of this AIA® Document, or any portion of it, may result in severe civil and criminal penalties, and will be prosecuted to the maximum extent possible under the law. Purchasers are permitted to reproduce ten (10) copies of this document when completed. To report copyright violations of AIA Contract Documents, e-mail The American Institute of Architects' legal counsel, copyright@aia.org.</p>								
<p>10-1204504</p>								

2. CONTRACTOR WAGE AFFIDAVIT

- A. Every contractor engaged in performance of any contract for Department of Public Works, Highway & Transportation shall submit to this Department, as requested and with final application for payment for work under said contract, affidavit in form as hereinafter set forth in this section. Affidavit affirms that all persons employed by contractor or by any of contractor's subcontractors on such contract have been paid no less than minimum wages established under Dane County Ordinances, Chapter 40, Subchapter II (Minimum Wage Ordinance) and in effect at date of execution of contract, that full payment of wages earned has been made, and that no rebates either directly or indirectly have been made. Form of such affidavit is included in this section.
- B. Form should be included with a copy of the final contract invoice forwarded to your contract representative at Dane County.

3. INSURANCE

A. **Contractor Carried Insurance.** In order to protect itself and the County, Contractor shall not commence work under this Contract until obtaining all required insurance and the County has approved such insurance. Contractor shall not allow any subcontractor to commence work on subcontract until insurance required of subcontractor has been so obtained and approved.

1. **Pollution Insurance Policy**

Contractor shall procure and maintain during life of this Contract, Pollution Insurance Policy in amount of at least \$1,000,000 per occurrence, \$5,000,000 aggregate.

SECTION 01 00 00
BASIC REQUIREMENTS

PART 1 GENERAL

1.1 SECTION SUMMARY

- A. Section Includes:
1. Section Summary
 2. Summary of the Work
 3. Contractor Use of Premises
 4. Applications for Payment
 5. Change Procedures
 6. Alternates
 7. Coordination
 8. Cutting and Patching
 9. Conferences
 10. Progress Meetings
 11. Submittal Procedures
 12. Proposed Products List
 13. Shop Drawings
 14. Product Data
 15. Samples
 16. Manufacturers' Instructions
 17. Manufacturers' Certificates
 18. Quality Assurance / Quality Control of Installation
 19. References
 20. Interior Enclosures
 21. Protection of Installed Work
 22. Parking
 23. Staging Areas
 24. Occupancy During Construction and Conduct of Work
 25. Protection
 26. Progress Cleaning
 27. Products
 28. Transportation, Handling, Storage and Protection
 29. Product Options
 30. Substitutions
 31. Starting Systems
 32. Demonstration and Instructions
 33. Contract Closeout Procedures
 34. Final Cleaning
 35. Adjusting
 36. Operation and Maintenance Data
 37. Spare Parts and Maintenance Materials
 38. As-Built and Record Drawings and Specifications

1.2 SUMMARY OF THE WORK

- A. Project Description: Perform the Work as specified and detailed in Construction Documents package. Contractor to provide construction services for one snowmobile bridge, approximately 50-feet in length. The bridge is to be set on pan footings.
- B. Work by Owner:
 - 1. Pre-construction clearing of trees and woody vegetation from the construction site.
 - 2. Post-construction removal of brush piles and woody debris.
 - 3. Post-construction disposal of removed existing bridge components.
- C. Permits: Owner has secured all necessary County/State erosion control/waterway/zoning permits.
- D. Diggers Hotline:
 - 1. It is General Contractor's responsibility to contact Diggers Hotline to have all utility locations marked prior to excavation and planning an excavation in a timely manner so as not to delay the Work.
 - 2. Diggers Hotline shall also be used to obtain information on safe working clearances from overhead lines.
 - 3. Completely comply with all requirements of each affected utility company.
 - 4. It is General Contractor's responsibility to contact & hire private utility locating services if necessary.

1.3 CONTRACTOR USE OF PREMISES

- A. Limit use of premises to allow work by others and work by Owner.

1.4 APPLICATIONS FOR PAYMENT

- A. Submit one (1) original copy with "wet" signatures of each application on AIA G702™ and G703™ forms or approved contractors invoice form.
- B. Content and Format: Utilize Schedule of Values for listing items in Application for Payment.
- C. Payment Period: Monthly.
- D. Submit Applications for Payment to Public Works Project Manager for approval & processing for payment.

1.5 CHANGE PROCEDURES

- A. Change Order Forms: Dane County Contract Change Order, Form 014-32-20 (latest issue).

- B. Contractor's costs for Products, delivery, installation, labor, insurance, payroll, taxes, bonding, equipment rental, overhead and profit will be included in Change Orders authorizing expenditure of funds from contingency allowance.

1.6 ALTERNATES

- A. Alternates quoted on Bid Form shall be reviewed and accepted or rejected at Owner's option.
- B. Coordinate related work and modify surrounding work as required.
- C. Schedule of Alternates: there are no alternates proposed for this project.

1.7 COORDINATION

- A. Coordinate scheduling, submittals, and work of various sections of Specifications to assure efficient and orderly sequence of installation of interdependent construction elements.
- B. Verify utility requirement characteristics of operating equipment are compatible with building utilities.
- C. Coordinate space requirements and installation of mechanical and electrical work that are indicated diagrammatically on Drawings.
- D. Contractor shall provide Public Works Project Engineer with work plan that ensures the Work will be completed within required time of completion.
- E. Public Works Project Manager may choose to photograph or videotape site or workers as the Work progresses.

1.8 CUTTING AND PATCHING

- A. Employ a skilled and experienced installer to perform cutting and patching new work; restore work with new Products.
- B. Submit written request in advance of cutting or altering structural or building enclosure elements.
- C. Fit work tight to adjacent elements. Maintain integrity of wall, ceiling, or floor construction; completely seal voids.
- D. Refinish surfaces to match adjacent finishes.

1.9 CONFERENCES

- A. There will be pre-bid conference for this project; see Instructions to Bidders.

- B. Owner will schedule a preconstruction conference after Award of Contract for all affected parties.
- C. Contractor shall submit Construction Schedule at pre-construction meeting.
- D. When required in individual Specification section, convene a pre-installation conference at project site prior to commencing work of Section.

1.10 PROGRESS MEETINGS

- A. Schedule and administer meetings throughout progress of the Work at minimum of one (1) per week with Public Works Project Manager.
- B. Preside at meetings, record minutes, and distribute copies within two (2) business days to those affected by decisions made.
- C. Attendance at progress meetings by General Contractor, subcontractors, or their authorized representative, is mandatory.
- D. Contractors shall give verbal reports of progress on the Work, discuss schedule for upcoming period and present all conflicts, discrepancies or other difficulties for resolution.
- E. Day & time of progress meetings to be determined at pre-construction meeting.

1.11 SUBMITTAL PROCEDURES

- A. Submittal form to identify Project, Contractor, Subcontractor or supplier; and pertinent Construction Documents references.
- B. Apply Contractor's stamp, signed or initialed, certifying that review, verification of Products required, field dimensions, adjacent construction work, and coordination of information is in accordance with requirements of the Work and Construction Documents.
- C. Identify variations from Construction Documents and Product or system limitations that may be detrimental to successful performance of completing the Work.
- D. Revise and resubmit submittals as required; identify all changes made since previous submittal.

1.12 PROPOSED PRODUCTS LIST

- A. Within fifteen (15) business days after date of Award of Contract, submit complete list of major Products proposed for use, with name of manufacturer, trade name, and model number of each Product.

1.13 SHOP DRAWINGS

- A. Submit number of copies that Contractor requires, plus three (3) copies that shall be retained by Public Works Project Manager.

1.14 PRODUCT DATA

- A. Submit number of copies that Contractor requires, plus two (2) copies that shall be retained by Public Works Project Manager.
- B. Mark each copy to identify applicable products, models, options, and other data. Supplement manufacturer's standard data to provide information unique to this Project.

1.15 SAMPLES

- A. Submit samples to illustrate functional and aesthetic characteristics of Product.
- B. Submit samples of finishes from full range of manufacturers' standard colors, textures, and patterns for Public Works Project Manager's selection.

1.16 MANUFACTURERS' INSTRUCTIONS

- A. When specified in individual Specification sections, submit manufacturers' printed instructions for delivery, storage, assembly, installation, start-up, adjusting, and finishing, in quantities specified for Product Data.

1.17 MANUFACTURERS' CERTIFICATES

- A. When specified in individual Specification sections, submit manufacturers' certificate to Public Works Project Manager for review, in quantities specified for Product Data.
- B. Indicate material or Product conforms to or exceeds specified requirements. Submit supporting reference data, affidavits, and certifications as appropriate.

1.18 QUALITY ASSURANCE / QUALITY CONTROL OF INSTALLATION

- A. Monitor quality control over suppliers, manufacturers, Products, services, site conditions, and workmanship, to produce work of specified quality.
- B. Comply fully with manufacturers' instructions.
- C. Comply with specified standards as minimum quality for the Work except when more stringent tolerances, codes, or specified requirements indicate higher standards or more precise workmanship.

1.19 REFERENCES

- A. Conform to reference standard by date of issue current as of date for receiving bids.

- B. Should specified reference standard conflict with Construction Documents, request clarification from Public Works Project Manager before proceeding.

1.20 INTERIOR ENCLOSURES

- A. Provide temporary partitions as required to separate work areas from Owner occupied areas, to prevent distribution of dust and moisture into Owner occupied areas, and to prevent damage to existing materials and equipment.

1.21 PROTECTION OF INSTALLED WORK

- A. Protect installed work and provide special protection where specified in individual Specification sections.

1.22 PARKING

- A. Arrange for temporary parking areas to accommodate construction personnel. Parking shall be available at the Work site.
- B. All contractors and their employees shall cooperate with General Contractor and others in parking of vehicles to avoid interference with normal operations and construction activities.
- C. Do not obstruct existing service drives and parking lots with equipment, materials and / or vehicles. Keep accessible for Owner's use at all times.

1.23 STAGING AREAS

- A. Coordinate staging areas with Public Works Project Manager prior to starting the Work.
- B. On-site space for use as staging areas and storage of materials is limited and will be apportioned among various Contractors as their needs dictate with due regard for storage requirements of each Contractor. Each Contractor shall be responsible for safety of equipment and materials that are stored on site.

1.24 OCCUPANCY DURING CONSTRUCTION AND CONDUCT OF WORK

- A. Smoking is prohibited on Dane County property.
- B. Owner reserves right at any time to dismiss from premises any Contractor or construction personnel that do not uphold requirements of this Section.
- C. Owner shall not be held liable for any lost time, wages, or impacts to construction schedule by any Contractor or construction personnel dismissed for failure to uphold requirements of this Section.
- D. Areas of existing facility will be occupied during period when the Work is in progress. Work may be done during normal business hours (8:00 am to 4:30 pm), but confer with Owner, schedule work and store materials so as to interfere as little as possible with

normal use of premises. Notify Owner when coring or similar noise making work is to be done and obtain Owner's written approval of schedule. If schedule is not convenient for Owner, reschedule and resubmit new times for Owner approval. Coring of floor along with other noisy work may have to be done on second and third shifts.

- E. Contractor shall, at all times, provide approved, safe walkways and facility entrances for use by Owner, employees and public.
- F. Contractor shall provide adequate protection for all parts of facility, its contents and occupants wherever the Work under this Contract is to be performed.
- G. Each Contractor shall arrange with Owner to make necessary alterations, do new work, make connections to all utilities, etc., at such times as will not cause interruption of utility services to facility. Contractor doing this work shall protect, cap, cut off and / or replace and relocate existing pipes, electrical work and other active utilities encountered which may interfere with new construction work.
- H. New work in extension of existing work shall correspond in all respects with that to which it connects or similar existing work unless otherwise indicated or specified.
 - 1. Existing work shall be cut, altered, removed or replaced as necessary for performance of Contract obligations.
 - 2. Work remaining in place, damaged or defaced by reason of work done under this Contract shall be restored equal to its condition at time of Award of Contract.
 - 3. If removal of work exposes discolored or unfinished surfaces or work out of alignment, such surfaces shall be refinished or materials replaced as necessary to make continuous work uniform and harmonious.
- I. Contractor is responsible for providing & maintaining temporary toilet facilities.

1.25 PROTECTION

- A. Contractor shall protect from damage / injury all trees, shrubs, hedges, plantings, grass, mechanical, electrical & plumbing equipment, walks and driveways and pay for any damage to same resulting from insufficient or improper protection.
- B. Contractor shall provide and maintain barricades & signage to prohibit public access to construction site.
- C. Contractor shall provide and maintain guard lights at all barricades, railings, obstructions in streets, roads or sidewalks and at all trenches adjacent to public walks or roads.

1.26 PROGRESS CLEANING

- A. Maintain areas free of waste materials, debris, and rubbish. Maintain site in clean and orderly condition.

1.27 PRODUCTS

- A. Products: Means new material, machinery, components, equipment, fixtures, and systems forming the Work, but does not include machinery and equipment used for preparation, fabrication, conveying and erection of the Work. Products may also include existing materials or components specifically identified for reuse.
- B. Do not use materials and equipment removed from existing premises, except as specifically identified or allowed by Construction Documents.

1.28 TRANSPORTATION, HANDLING, STORAGE AND PROTECTION

- A. Transport, handle, store and protect Products in accordance with manufacturer's instructions.

1.29 PRODUCT OPTIONS

- A. Where definite material is specified, it is not intentional to discriminate against "equal" product made by another manufacturer. Intention is to set definite standard of material quality. Should bidder choose to bid materials other than those specified, bidder shall submit said materials specifications to Public Works Project Manager for approval at least seven (7) business days prior to Bid Due Date.
- B. Products and materials that are not specified, but have been approved for use by Public Works Project Manager shall be identified in addenda to all bidding contractors.
- C. Requests for material or product substitutions submitted after Bid Due Date may be considered. Owner reserves right to approve or reject substitutions based on Specification requirements and intended use.

1.30 SUBSTITUTIONS

- A. Public Works Project Manager shall consider requests for Substitutions only within fifteen (15) calendar days after date of Public Works Construction Contract.
- B. Document each request with complete data substantiating compliance of proposed Substitution with Construction Documents.
- C. Submit three (3) copies of requests for Substitution for consideration. Limit each request to one (1) proposed Substitution.
- D. Substitutions shall not change contract price established at Bid Due Date.

1.31 STARTING SYSTEMS

- A. Provide written notification prior to start-up of each equipment item or system.
- B. Ensure that each piece of equipment or system is ready for operation.

- C. Execute start-up under supervision of responsible persons in accordance with manufacturers' instructions.
- D. Submit written report that equipment or system has been properly installed and is functioning correctly.

1.32 DEMONSTRATION AND INSTRUCTIONS

- A. Demonstrate operation and maintenance of Products to Owner's personnel prior to date of final inspection.
- B. Demonstrate start-up, operation, control, adjustment, trouble-shooting, servicing, maintenance, and shutdown of each item of equipment at agreed-upon times, at designated location.
- C. Owner may choose to photograph or videotape demonstration session; demonstration and demonstrator shall be to level of satisfaction of Owner.

1.33 CONTRACT CLOSEOUT PROCEDURES

- A. Submit written certification that Construction Documents have been reviewed, the Work has been inspected, and the Work is complete in accordance with Construction Documents and ready for Public Works Project Manager's inspection.
- B. Submit final Application for Payment identifying total adjusted Contract Sum / Price, previous payments, and amount remaining due.

1.34 FINAL CLEANING

- A. Execute final cleaning prior to final inspection.
- B. Clean interior and exterior surfaces exposed to view.
- C. Remove waste and surplus materials, rubbish, and construction facilities from site.

1.35 ADJUSTING

- A. Adjust operating Products and equipment to ensure smooth and unhindered operation.

1.36 OPERATION AND MAINTENANCE MANUAL

- A. Provide two (2) bound, hard-copy operation and maintenance manuals that include all systems, materials, products, equipment, mechanical and electrical equipment and systems supplied and installed in the Work. Provide electronic version of operation and maintenance manual also.

1.37 SPARE PARTS AND MAINTENANCE MATERIALS

- A. Provide Products, spare parts, maintenance and extra materials in quantities specified in individual Specification Sections.
- B. Deliver to the Work site and place in location as directed.

1.38 AS-BUILT AND RECORD DRAWINGS AND SPECIFICATIONS

- A. Contractor-produced Drawings and Specifications shall remain property of Contractor whether Project for which they are made is executed or not. Contractor shall furnish Public Works Project Manager with original marked up redlines of Construction Documents' drawings and specifications that shall include all Addendums, Change Orders, Construction Bulletins, on-site changes, field corrections, etc. These are project As-Built Drawings & Specifications. Record Drawings & Specifications shall be created from these As-Built by Public Works.
- B. Architect / Engineer shall update original Construction Documents to include all Addendums & any other changes including those provided by Contractor in As-Built Drawings & Specifications. These updates are project Record Drawings & Specifications.
- C. Architect / Engineer shall furnish Public Works Project Manager with Record Drawings as detailed in Professional Services Agreement.

PART 2 PRODUCTS

Not Used.

PART 3 EXECUTION

Not Used.

END OF SECTION

SECTION 01 74 19

CONSTRUCTION WASTE MANAGEMENT, DISPOSAL & RECYCLING

PART 1 GENERAL

1.1 SUMMARY

- A. Section Includes:
 - 1. Summary
 - 2. Waste Management Goals
 - 3. Construction and / or Demolition Waste Management
 - 4. Waste Management Plan
 - 5. Reuse
 - 6. Recycling
 - 7. Materials Sorting and Storage On Site
 - 8. Lists of Recycling Facilities Processors and Haulers
 - 9. Waste Management Plan Form

- B. Related Sections:
 - 1. Section 01 00 00 - Basic Requirements

1.2 WASTE MANAGEMENT GOALS

- A. Dane County requires that as many waste materials as possible produced as result of this project be salvaged, reused or recycled in order to minimize impact of construction waste on landfills and to minimize expenditure of energy and cost in fabricating new materials. Additional information may be found in Dane County Green Building Policy, Resolution 299, 1999-2000.

1.3 CONSTRUCTION AND / OR DEMOLITION WASTE MANAGEMENT

- A. All construction and demolition waste suitable for recycling must go to Dane County Construction & Demolition Recycling Facility located at 7102 US Hwy 12, Madison, located across from Yahara Hills Golf Course. This facility can receive mixed loads of construction and demolition waste. For complete list of acceptable materials see www.countyofdane.com/pwht/recycle/CD_Recycle.aspx.
- B. Dane County Landfill, also at 7102 US Hwy 12, Madison, must receive all other waste from this project. www.countyofdane.com/pwht/recycle/landfill.aspx.

1.4 WASTE MANAGEMENT PLAN

- A. Contractor shall develop Waste Management Plan (WMP) for this project. Dane County's Special Projects & Materials Manager may be contacted with questions. Outlined in RECYCLING section of this specification are examples of materials that can be recycled or reused as well as recommendations for waste sorting methods.

B. Contractor shall complete WMP and include cost of recycling / reuse in Bid. WMP will be submitted to Public Works Project Manager within fifteen (15) business days of Bid Due date. Copy of blank WMP form is in this Section. Submittal shall include cover letter and WMP form with:

1. Information on:
 - a. Types of waste materials produced as result of work performed on site;
 - b. Estimated quantities of waste produced;
 - c. Identification of materials with potential to be recycled or reused;
 - d. How materials will be recycled or reused;
 - e. On-site storage and separation requirements (on site containers);
 - f. Transportation methods; and
 - g. Destinations.

1.5 REUSE

A. Contractors and subcontractors are encouraged to reuse as many waste materials as possible. Salvage should be investigated for materials not reusable on site.

1.6 RECYCLING

A. These materials must be recycled at Dane County Construction & Demolition Recycling Facility:

1. Wood.
2. Wood Pallets.
3. PVC Plastic (pipe, siding, etc.).
4. Asphalt & Concrete.
5. Bricks & Masonry.
6. Cardboard.
7. Metal.

B. These materials can be recycled elsewhere in Dane County area:

1. Fluorescent Lamps.
2. Foam Insulation & Packaging (extruded and expanded).
3. Barrels & Drums.

C. All materials must be recycled at WDNR permitted waste processing facilities that adhere to all State Statutes.

1.7 MATERIALS SORTING AND STORAGE ON SITE

A. Contractor shall provide separate containers for recyclable materials. Number of containers will be dependent upon project and site conditions.

B. Contractor shall provide on-site locations for subcontractors supplied recycling containers to help facilitate recycling.

C. Mixed loads of recycled materials are allowed only per instructions at www.countyofdane.com/pwht/recycle/CD_Recycle.aspx.

1.8 LISTS OF RECYCLING FACILITIES PROCESSORS AND HAULERS

- A. Refer to www.countyofdane.com/pwht/recycle/CD_Recycle.aspx for information on Dane County Construction & Demolition Recycling Facility.
- B. Web site www.countyofdane.com/pwht/recycle/categories.aspx lists current information for Dane County Recycling Markets. Contractors can also contact Allison Hackner at 608/266-4990, or local city, village, town recycling staff listed at site www.countyofdane.com/pwht/recycle/contacts.aspx. Statewide listings of recycling / reuse markets are available from UW Extension at <https://www.uwgb.edu/shwec/>.

PART 2 PRODUCTS

Not Used.

PART 3 EXECUTION

Not Used.

END OF SECTION

WASTE MANAGEMENT PLAN FORM



Contractor Name: _____

Address: _____

Phone No.: _____ Recycling Coordinator: _____

MATERIAL	ESTIMATED QUANTITY	DISPOSAL METHOD (CHECK ONE)		RECYCLING / REUSE COMPANY OR DISPOSAL SITE
Salvaged & reused building materials	_____ cu. yds. _____ tons	_____ Recycled	_____ Reused	Name: _____
		_____ Landfilled	_____ Other	
Wood	_____ cu. yds. _____ tons	_____ Recycled	_____ Reused	Name: _____
		_____ Landfilled	_____ Other	
Wood Pallets	_____ units	_____ Recycled	_____ Reused	Name: _____
		_____ Landfilled	_____ Other	
PVC Plastic	_____ cu. ft. _____ lbs.	_____ Recycled	_____ Reused	Name: _____
		_____ Landfilled	_____ Other	
Asphalt & Concrete	_____ cu. ft. _____ lbs.	_____ Recycled	_____ Reused	Name: _____
		_____ Landfilled	_____ Other	
Bricks & Masonry	_____ cu. ft. _____ lbs.	_____ Recycled	_____ Reused	Name: _____
		_____ Landfilled	_____ Other	
Cardboard	_____ cu. ft. _____ lbs.	_____ Recycled	_____ Reused	Name: _____
		_____ Landfilled	_____ Other	
Metals	_____ cu. yds. _____ tons	_____ Recycled	_____ Reused	Name: _____
		_____ Landfilled	_____ Other	
Fluorescent Lamps	_____ cu. ft. _____ lbs.	_____ Recycled	_____ Reused	Name: _____
		_____ Landfilled	_____ Other	
Foam Insulation	_____ cu. ft. _____ lbs.	_____ Recycled	_____ Reused	Name: _____
		_____ Landfilled	_____ Other	
Barrels & Drums	_____ units	_____ Recycled	_____ Reused	Name: _____
		_____ Landfilled	_____ Other	
Glass	_____ cu. yds. _____ tons	_____ Recycled	_____ Reused	Name: _____
		_____ Landfilled	_____ Other	
Other	_____	_____ Recycled	_____ Reused	Name: _____
		_____ Landfilled	_____ Other	
Other	_____	_____ Recycled	_____ Reused	Name: _____
		_____ Landfilled	_____ Other	
Other	_____	_____ Recycled	_____ Reused	Name: _____
		_____ Landfilled	_____ Other	

SECTION 32 34 00

PREFABRICATED STEEL BRIDGE

PART 1 GENERAL

1.1 SECTION SUMMARY

- A. Section Includes
 - 1. Basic Information
 - 2. Features of Design
 - 3. Design Requirements

1.2 BASIC INFORMATION

- A. This specification is for a clear span bridge designed to carry trail maintenance equipment (tractor units, etc.) and snowmobile traffic.
- B. Contractor is responsible for hiring a licensed Professional Engineer (PE), registered in the State of Wisconsin, to design and approve bridge and bridge end anchorage structures. Construction drawings stamped by the Engineer must be submitted to Public Works Project Manager for approval prior to beginning construction.
- C. Owner has secured all necessary County/State erosion control/waterway/zoning permits.

1.3 FEATURES OF DESIGN

- A. Site Regrading
 - 1. Re-grade bridge approaches and add ¾" crushed limestone as needed to allow smooth transition for snowmobiles and trail maintenance equipment (tractor units, etc.).
- B. Span:
 - 1. Total span for the bridge shall be approximately 50-foot length.
 - 2. Bridge shall be a clear span design with bridge anchorage structures on either end and no central support.
 - 3. Contractor shall verify span. Location of new bridge anchorage structures shall not significantly change bridge span.
- C. Width:
 - 1. Width of usable bridge deck shall be a minimum of 12'. Usable bridge deck shall be defined as shortest distance across (perpendicular to centerline) bridge deck from any component above bridge deck.
- D. Structural Steel
 - 1. All structural steel shall meet ASTM-A 572 Grade 50/A992 with minimum yield strength of 50,000 psi.
 - 2. All structural steel shall be primed with red oxide primer, military standard TT-P-

664D. Contractor to touch up in field as required.

3. Structural steel size shall be determined by Wisconsin licensed Professional Engineer.

E. Railings:

1. Railings shall be MCA treated Southern Yellow Pine #1.
2. Horizontal safety railings shall cover both sides of bridge for entire span of bridge. Railings shall be a minimum of 42" above bridge deck.
3. Additional safety protection shall be installed between bridge deck and horizontal railing for the entire span length. Protection between deck and railings shall be designed to prevent a 6" sphere from passing through.

F. Deck

1. Bridge deck shall be wooden deck supported on structural steel and conform to WDNR loading guidelines.
2. Wood shall be MCA treated Southern Yellow Pine #1. Fresh cut ends of wood shall be treated to prevent deterioration.

G. Bridge anchorage structures

1. Design of bridge anchorage structure is responsibility of contractor
2. Acceptable bridge anchorage structures types include; concrete wall bridge anchorage structures, helical pilings, portable bridge footing with riser, concrete piers, or pan-style bridge anchorage system. Bridge anchorage structures are to be designed by registered Wisconsin professional engineer. Submit stamped drawings to Public Works Project Manager.

H. Miscellaneous

1. All hardware shall be galvanized or stainless steel grade 304.
2. Provide steel tread plate as required.
3. All disturbed areas shall be seeded with Reinders No Mow/Low Grow (or equivalent) at rate of 6 lbs. per 1,000 sq. ft.
4. An urban/net free erosion control mat shall be placed over all newly seeded areas and stapled per manufacturer's instructions, including disturbed areas underneath bridge.
5. Contractor is responsible for ensuring design, materials, and method of construction meet DNR regulations.
6. Contractor will remove existing bridge from site and place on bank, in location approved by owner. Owner is responsible for disposal of existing bridge.

1.4 DESIGN REQUIREMENTS:

A. Design of bridge and bridge anchorage structures shall be done by Professional Engineer registered in the state of Wisconsin.

B. Bridge Structure:

1. Bridge design load shall be capable of supporting snowmobile traffic and trail maintenance equipment (tractor units, etc.) as determined by engineer.
2. At minimum bridge shall be capable of supporting 60 lbs. pedestrian live load per square

foot.

3. At minimum bridge shall be capable of supporting 20,000 lbs. vehicle load mid span.
4. Design shall conform with Wisconsin Department of Natural Resources (WDNR) guidelines and all applicable requirements for permitting by the state of Wisconsin.

PART 2 PRODUCTS

2.1 PREFABRICATED BRIDGE MANUFACTURERS

- A. The following is a list of approved prefabricated bridge manufacturers:
 1. Custom Manufacturing Inc.
 2. Wickcraft, Inc.
 3. Wheeler Bridge
 4. American Bridge
 5. Continental Bridge Manufacturing

- B. See section 01 00 00 Basic Requirements, for information on requesting substitutions.

PART 3 EXECUTION

3.1 ERECTION

- A. Protect waterway from debris and pollution. All applicable county, state, and federal regulations must be followed.

- B. Contractor shall be responsible for repairing damage to site and staging areas caused by equipment or materials.

- C. Contractor responsible for erosion control methods and maintenance throughout project duration. Prior to project completion, all disturbed areas shall be temporarily covered with straw mulch by the end of the day prior to forecasted measurable rain events. All disturbed areas shall be permanently seeded and covered with urban/net free erosion control mat upon completion of the project.

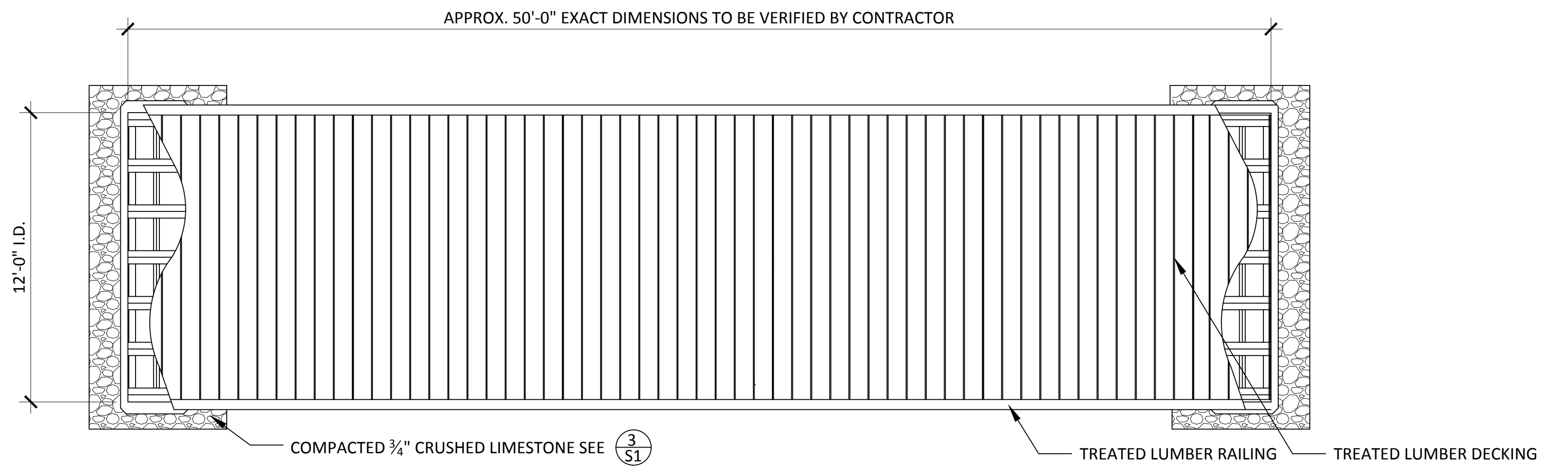

1
S1 BRIDGE PLAN
NTS

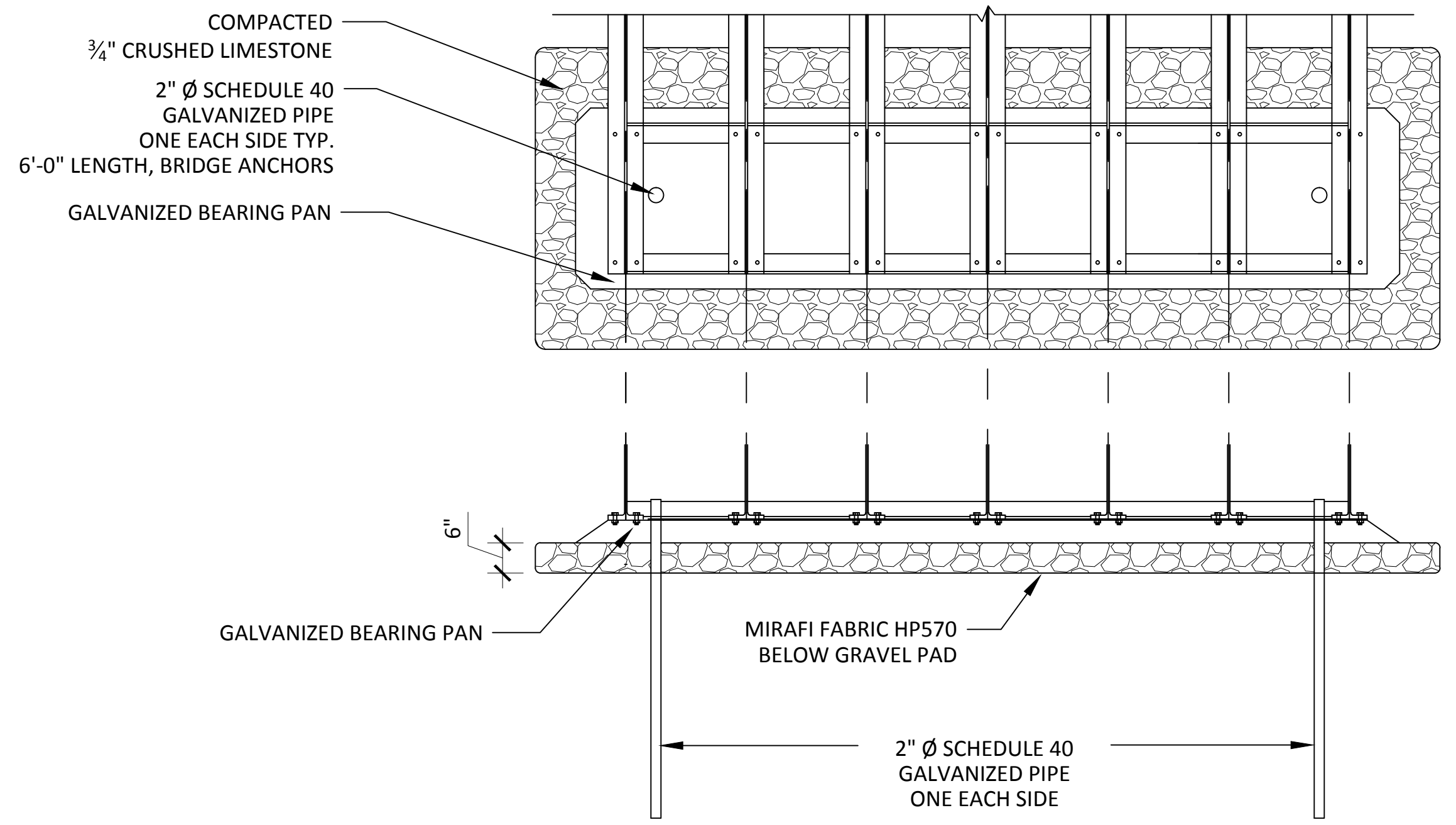

3
S1 GRAVEL PAD & GALVANIZED BASE DETAILS
NTS

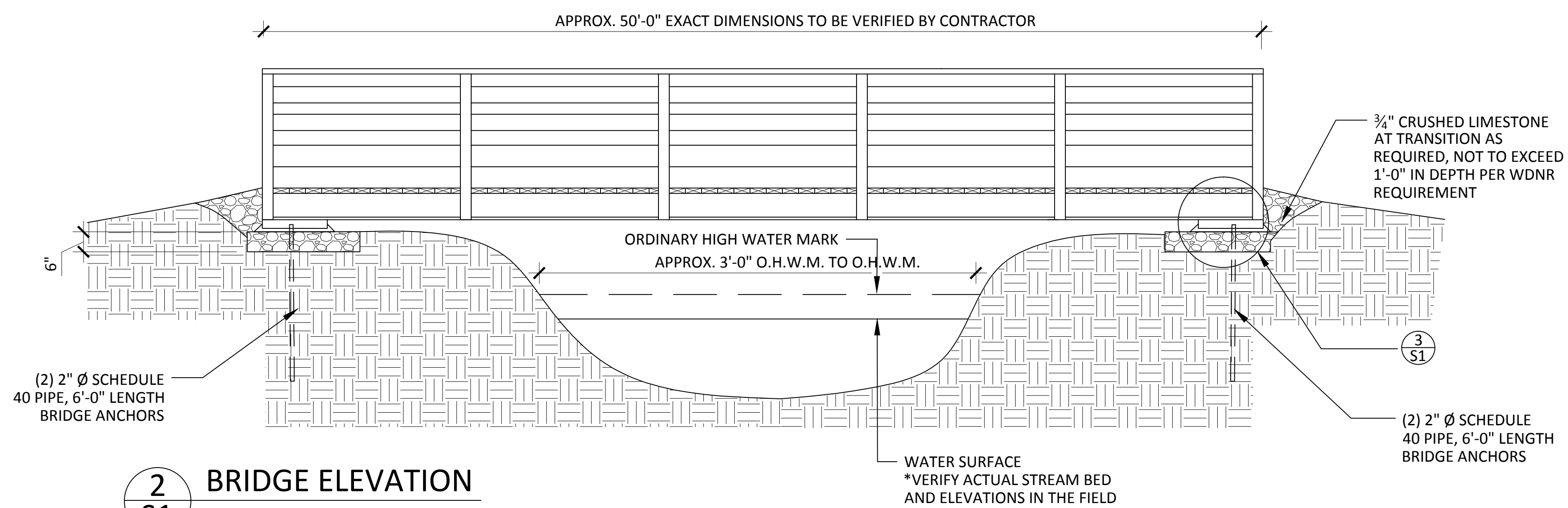

2
S1 BRIDGE ELEVATION
NTS

NOTES:

1. DANE COUNTY IS NOT RESPONSIBLE FOR CONSTRUCTION MEANS OR METHODS OR FOR SUPERVISION OF CONSTRUCTION
2. ALL DIMENSIONS SHALL BE FIELD VERIFIED BY CONTRACTOR PRIOR TO BRIDGE FABRICATION. ANY DIMENSIONAL DISCREPANCIES ARE TO BE BROUGHT TO THE ATTENTION OF THE DANE COUNTY PUBLIC WORKS ENGINEERING DIVISION PRIOR TO PROCEEDING WITH FABRICATION OF THE BRIDGE. FINAL PLANS AND SPECIFICATIONS SHALL BE STAMPED ENGINEERING DRAWINGS APPROVED BY A WISCONSIN REGISTERED STRUCTURAL ENGINEER OR PREVIOUSLY APPROVED DRAWINGS.
3. ALL WORK IS TO BE PERFORMED IN A SAFE AND WORKMAN-LIKE MANNER IN COMPLIANCE WITH THE FEDERAL OCCUPATIONAL SAFETY AND HEALTH ACT (OSHA) AND ALL STATE OF WISCONSIN BUILDING CODES AND ZONING ORDINANCES AS THEY MAY PERTAIN TO THIS PROJECT. THE CONTRACTOR MUST COMPLY WITH ALL WISCONSIN DEPARTMENT OF NATURAL RESOURCES (WDNR) AND ARMY CORPS OF ENGINEERS RULES AND REGULATIONS ASSOCIATED WITH CROSSING WATERWAYS. DANE COUNTY PARKS DIVISION WILL SECURE ALL NECESSARY WATER REGULATORY PERMITS AND APPROVALS FROM THE WISCONSIN DNR AND ARMY CORPS OF ENGINEERS AND DANE COUNTY PRIOR TO CONSTRUCTION. CONTRACTOR MUST ADHERE TO THE WDNR CHAPTER 30 PERMIT AND THE DANE COUNTY SHORELAND EROSION CONTROL PERMIT REQUIREMENTS WHILE COMPLETING THE CONSTRUCTION OF THE BRIDGE.
4. THE CONTRACTOR IS RESPONSIBLE FOR ALL TEMPORARY BRACING DURING HANDLING AND ERECTION OF THE BRIDGE.
5. BRIDGE AND GRAVEL APPROACHES MUST MEET THE REQUIREMENTS OF THE AMERICANS WITH DISABILITIES ACT (ADA).
6. CONTRACTOR IS TO PROVIDE FINAL BRIDGE DESIGN WITH NECESSARY APPROACHES AND STRUCTURAL ELEMENTS FOR APPROVAL BY DANE COUNTY PUBLIC WORKS ENGINEERING DIVISION.
7. THE CONTRACTOR IS TO VERIFY ALL CONDITIONS AT THE SITE, PARTICULARLY THE LOCATION OF ANY UNDERGROUND UTILITIES BEFORE EXCAVATION. ANY DISCREPANCIES ARE TO BE BROUGHT TO THE ATTENTION OF DANE COUNTY PUBLIC WORKS ENGINEERING DIVISION.
8. THE CONTRACTOR IS RESPONSIBLE FOR SOIL COMPACTION TESTING AND FOR PROVIDING A BRIDGE DESIGN TO MEET THE SOIL TYPE.
9. BRIDGE LOAD CAPACITY: 14,000 LBS.

BRIDGE TO BANK TRANSITION:

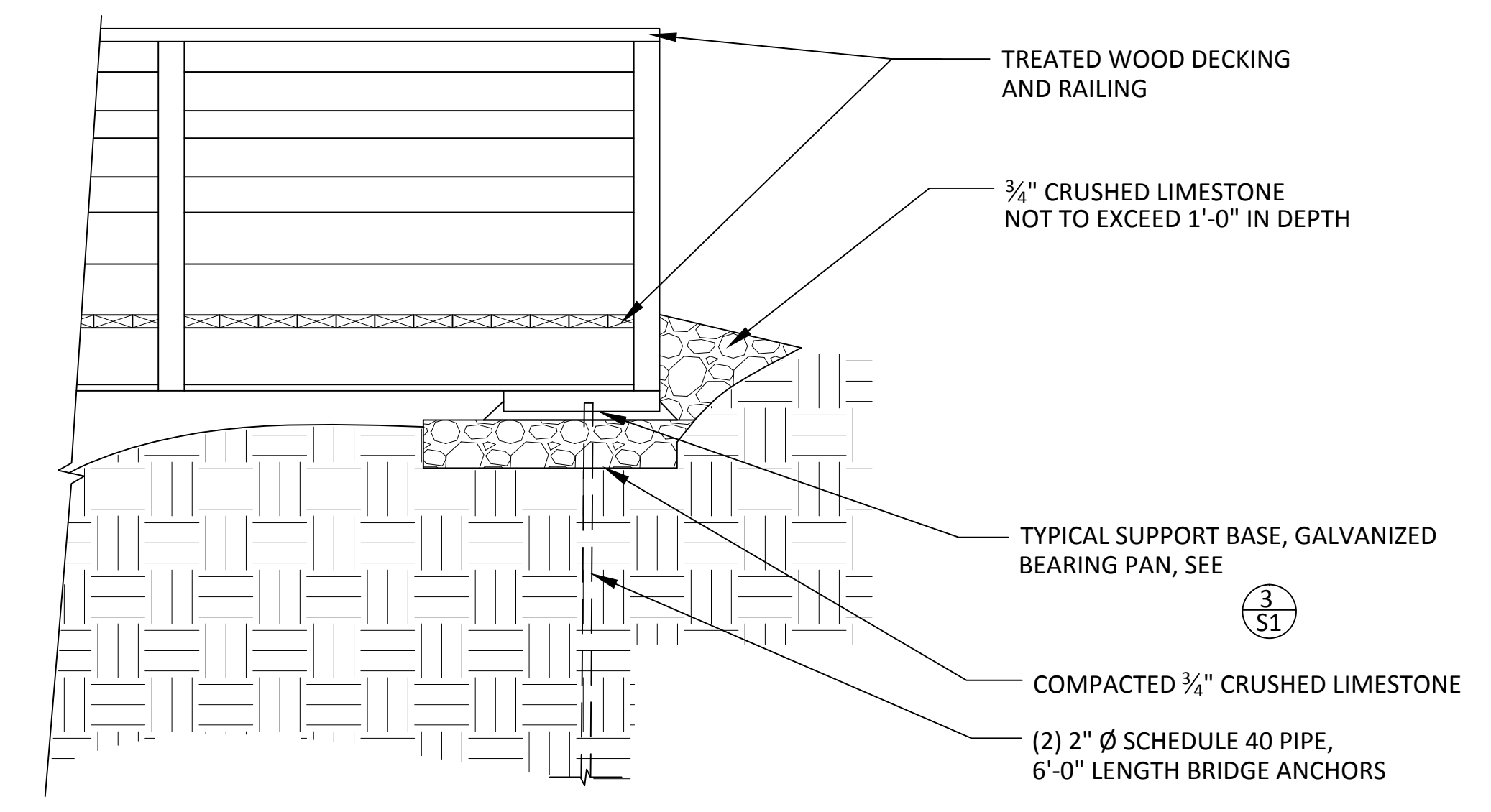

AT GRADE BANK TRANSITION
NTS

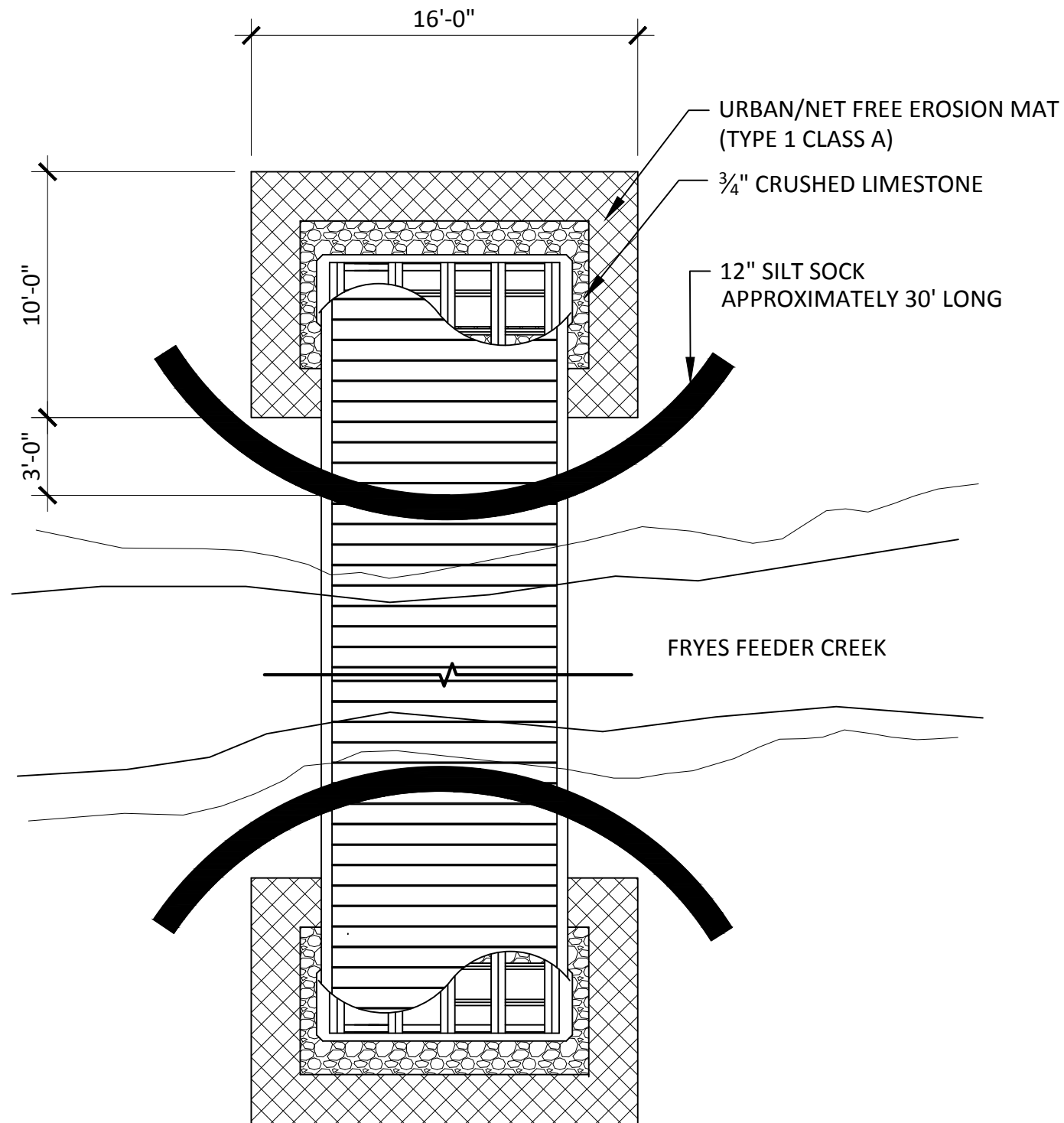

FRYES FEEDER CREEK SNOWMOBILE BRIDGE

PLAN VIEW

NTS

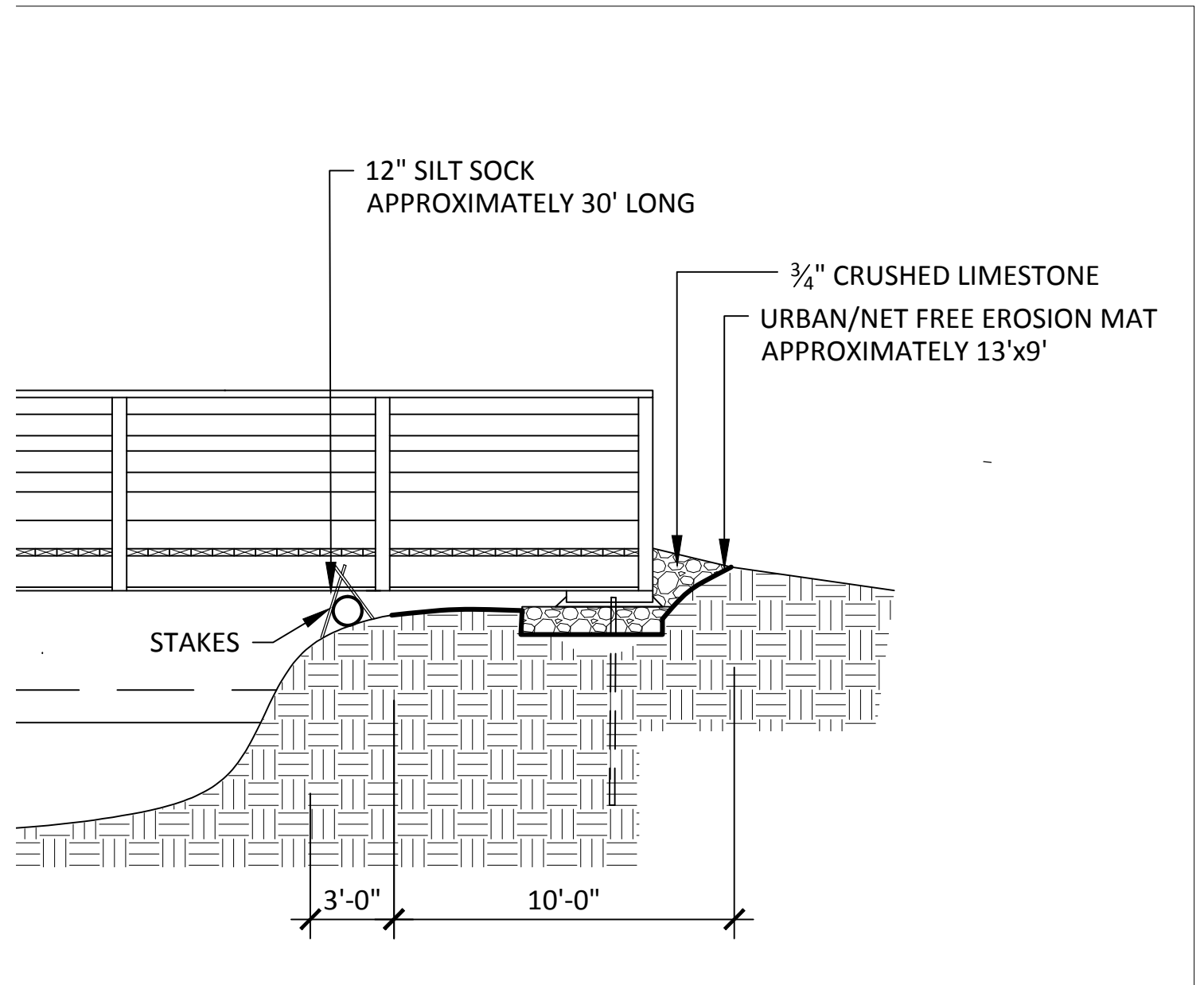

FRYES FEEDER CREEK SNOWMOBILE BRIDGE

ELEVATION VIEW

NTS

SHEET 2 OF 2

DATE: JULY 3, 2017



Fryes Feeder Creek Bridge

Proposed Location

Donald County Park- State Hwy 92
Town of Springdale

Attachment B

