



RFB NO. 320037

CONSTRUCTION DOCUMENTS PROJECT MANUAL

DANE COUNTY DEPARTMENT OF PUBLIC WORKS,
HIGHWAY AND TRANSPORTATION

PUBLIC WORKS ENGINEERING DIVISION
1919 ALLIANT ENERGY CENTER WAY
MADISON, WISCONSIN 53713

REQUEST FOR BIDS NO. 320037 FUELING FACILITY UPGRADES HIGHWAY DEPT. - EAST DISTRICT CAMPUS 3103 LUDS LANE MCFARLAND, WISCONSIN

Due Date / Time: **TUESDAY, NOVEMBER 17, 2020 / 2:00 P.M.**

Location: **PUBLIC WORKS OFFICE**

Performance / Payment Bond: **100% OF CONTRACT AMOUNT**

Bid Deposit: **5% OF BID AMOUNT**

FOR INFORMATION ON THIS REQUEST FOR BIDS, PLEASE CONTACT:

RYAN SHORE, PROJECT MANAGER
TELEPHONE NO.: 608/445-0109
FAX NO.: 608/267-1533
E-MAIL: SHORE@COUNTYOFDANE.COM

SECTION 00 01 10

TABLE OF CONTENTS

DIVISION 00 - PROCUREMENT AND CONTRACTING REQUIREMENTS

- 00 01 01 - Project Manual Cover Page
- 00 01 10 - Table of Contents
- 00 11 16 - Invitation to Bid
- 00 21 13 - Instructions to Bidders
- 00 41 13 - Bid Form
- 00 52 96 - Sample Public Works Construction Contract
- 00 61 12 - Sample Bid Bond
- 00 61 13.13 - Sample Performance Bond
- 00 61 13.16 - Sample Payment Bond
- 00 72 13 - General Conditions of Contract
- 00 73 00 - Supplementary Conditions
- 00 73 07 - Best Value Contracting Application
- 00 73 11 - Fair Labor Practices Certification

DIVISION 01 - GENERAL REQUIREMENTS

- 01 00 00 - General Requirements
- 01 74 19 - Construction Waste Management, Disposal & Recycling

DRAWINGS

Plot drawings on 22" x 34" (ANSI D) paper for correct scale or size.

- 01 - Cover Sheet
- C-1 - Site Layout
- C-2 - Site Plan
- M-1 - Mechanical Piping Layout
- M-2 - High Pressure Tubing Layout
- M-3 - Utility Piping Isometric Layout
- 02 - Civil and Mechanical Details

END OF SECTION

SECTION 01 11 16

INVITATION TO BID

LEGAL NOTICE

Dane County Dept. of Public Works, Hwy & Transp., 1919 Alliant Energy Center Way, Madison, WI 53713, will receive sealed Bids until:

2:00 P.M., TUESDAY, NOVEMBER 17, 2020

RFB NO. 320037

FUELING FACILITY UPGRADES

HIGHWAY DEPT. – EAST DISTRICT CAMPUS

3103 LUDS LANE, MCFARLAND, WI

Dane County is inviting Bids for construction services to provide mechanical piping and high pressure tubing for a new compressed natural gas (CNG) system. Only firms with capabilities, experience & expertise with similar projects should obtain this Request for Bids (RFB) document & submit Bids.

RFB document may be obtained after **2:00 p.m. on October 27, 2020** by downloading it from bids-pwht.countyofdane.com. Please call Ryan Shore, Project Mgr., at 608/445-0109, or our office at 608/266-4018, for any questions or additional information.

All Bidders must be qualified as a Best Value Contractor before Bid Due Date / Time. Complete Pre-qualification Application for Contractors at publicworks.countyofdane.com/bvc or obtain one by calling 608/267-0119.

A pre-bid site tour will be held Wednesday, November 4 at 8:00 a.m. at the Dane County Highway Department East District Campus, 3103 Luds Lane, Bidders are strongly encouraged to attend this tour. See RFB for mandatory disease transmission prevention practices.

**PUBLISH: OCTOBER 27 & NOVEMBER 3, 2020 - WISCONSIN STATE JOURNAL
 OCTOBER 28 & NOVEMBER 4, 2020 - THE DAILY REPORTER**

END OF SECTION

SECTION 00 21 13

INSTRUCTIONS TO BIDDERS

TABLE OF CONTENTS

1. GENERAL.....	1
2. DRAWINGS AND SPECIFICATIONS	2
3. INTERPRETATION	2
4. QUALIFICATIONS OF BIDDER (CONTRACTOR AND SUBCONTRACTOR)....	2
5. BID GUARANTEE	3
6. WITHDRAWAL OF BIDS.....	3
7. CONTRACT FORM	3
8. CONTRACT INTERESTS BY COUNTY PUBLIC OFFICIALS	4
9. EMERGING SMALL BUSINESS PROVISIONS	4
10. METHOD OF AWARD - RESERVATIONS	4
11. SECURITY FOR PERFORMANCE AND PAYMENTS	4
12. TAXES	5
13. SUBMISSION OF BIDS	5
14. SUBCONTRACTOR LISTING.....	6
15. ALTERNATE BIDS	6
16. INFORMATIONAL BIDS	6
17. UNIT PRICES.....	6
18. COMMENCEMENT AND COMPLETION	6
19. WORK BY OWNER	6
20. SPECIAL HAZARDS COVERAGE	6

1. GENERAL

- A. Before submitting Bid, bidder shall thoroughly examine all Construction Documents. Successful Bidder shall be required to provide all the Work that is shown on Drawings, set forth in Specifications, or reasonably implied as necessary to complete Contract for this project.
- B. Bidder shall visit site to become acquainted with adjacent areas, means of approach to site, conditions of actual site and facilities for delivering, storing, placing, and handling of materials and equipment.
- C. Pre-bid meeting is scheduled on Wednesday, November 4 at the Dane County Highway Dept East District Campus, 3103 Luds Lane, McFarland, WI. Attendance by all bidders is optional, however bidders and subcontractors are strongly encouraged to attend.
- D. Safe distancing & face masks are required for all tour attendees. Tours will be limited to 10 people; please limit number of attending staff & subcontractors. If there are more than 10 people, group will be split & there will be two or more tours. Allow sufficient time if you do not make it in to first tour group.
- E. Failure to visit site or failure to examine any and all Construction Documents will in no way relieve successful Bidder from necessity of furnishing any necessary materials or equipment, or performing any work, that may be required to complete the Work in accordance with Drawings and Specifications. Neglect of above requirements will not be accepted as reason for delay in the Work or additional compensation.

2. DRAWINGS AND SPECIFICATIONS

- F. Drawings and Specifications that form part of this Contract, as stated in Article 1 of General Conditions of Contract, are enumerated in Document Index of these Construction Documents.
- G. Complete sets of Drawings and Specifications for all trades will be available to all Bidders, irrespective of category of work to be bid on, in order that all Bidders may be familiar with work of other trades as they affect their bid.

3. INTERPRETATION

- A. No verbal explanation or instructions will be given in regard to meaning of Drawings or Specifications before Bid Due Date. Bidders shall bring inadequacies, omissions or conflicts to Owner or Architect / Engineer's attention at least ten (10) calendar days before Bid Due Date. Prompt clarification will be available to all bidders by Addendum.
- B. Failure to so request clarification or interpretation of Drawings and Specifications will not relieve successful Bidder of responsibility. Signing of Contract will be considered as implicitly denoting that Contractor has thorough understanding of scope of the Work and comprehension of Construction Documents.
- C. Owner or Consultant / Engineer will not be responsible for verbal instructions.

4. QUALIFICATIONS OF BIDDER (CONTRACTOR AND SUBCONTRACTOR)

- A. Before award of Contract can be approved, Owner shall be satisfied that Bidder involved meets following requirements:
 - 1. Has completed at least one (1) project of at least fifty percent (50%) of size or value of Division of work being bid and type of work completed is similar to that being bid. If greater magnitude of experience is deemed necessary, other than size or value of work, such requirements will be described in appropriate section of Specifications.
 - 2. Maintains permanent place of business.
 - 3. Can be bonded for terms of proposed Contract.
 - 4. Meets all applicable Best Value Contractor requirements.
 - 5. Has record of satisfactorily completing past projects. Criteria which will be considered in determining satisfactory completion of projects by bidder will include:
 - a. Completed contracts in accordance with drawings and specifications.
 - b. Diligently pursued execution of work and completed contracts according to established time schedule unless Owner grants extensions.
 - c. Fulfilled guarantee requirements of construction documents.
 - d. Is not presently on ineligible list maintained by County's Department of Administration for noncompliance with equal employment opportunities and affirmative action requirements.
 - e. Authorized to conduct business in Wisconsin. By submitting Bid, bidder warrants that it has: complied with all necessary requirements to do business in State of Wisconsin; that persons executing contract on its behalf are authorized to do so; and, if corporation, that name and address of bidder's registered agent are as set forth in Contract. Bidder shall notify Owner immediately, in writing, of any change in its

registered agent, their address, and bidder's legal status. For partnership, term "registered agent" shall mean general partner.

- B. County's Public Works Project Manager will make such investigations as are deemed necessary to determine ability of bidder to perform the Work, and bidder shall furnish to County's Public Works Project Manager or designee all such information and data for this purpose as County's Public Works Project Manager may request. Owner reserves right to reject Bid if evidence submitted by, or investigation of, bidder fails to satisfy Owner that bidder is responsible and qualified to carry out obligations of Contract and to complete the Work contemplated therein.

5. BID GUARANTEE

- A. Bank certified check, cashier's check or Bid Bond, payable to County in amount not less than five percent (5%) of maximum bid, shall accompany each Bid as guarantee that if Bid is accepted, Bidder will execute and return proposed Contract and Performance and Payment Bonds within ten (10) business days after being notified of acceptance of Bid. Company issuing bonds must be licensed to do business in Wisconsin.
- B. Any bid, which is not accompanied by bid guarantee, will be considered "No Bid" and will not be read at Bid Due Date.
- C. If successful Bidder so delivers Contract, Certificate of Insurance, and Performance and Payment Bonds, check will be returned to Bidder. In case Bidder fails to deliver such Contract, insurance, and bond, amount of bid guarantee will be forfeited to County as liquidated damages.
- D. All checks tendered as bid guarantee, except those of three (3) lowest qualified, responsible bidders, will be returned to their makers within three (3) business days after Bid Due Date. All such retained checks will be returned immediately upon signing of Contract and Performance and Payment Bonds by successful Bidder.

6. WITHDRAWAL OF BIDS

- A. Bids may be withdrawn by written request received from bidder or authorized representative thereof prior to time fixed for Bid Due Date, without prejudice to right of bidder to file new Bid. Withdrawn Bids will be returned unopened. Negligence on part of bidder in preparing their Bid confers no right for withdrawal of Bid after it has been opened.
- B. No Bid may be withdrawn for period of sixty (60) calendar days after Bid Due Date.
- C. If Bid contains error, omission or mistake, bidder may limit liability to amount of bidder's guarantee by giving written Notice of Intent not to execute Contract to Owner within seventy-two (72) hours of Bid Due Date.

7. CONTRACT FORM

- A. Sample copy of contract that successful Bidder will be required to enter into is included in these Construction Documents and bidders are required to familiarize themselves with all conditions contained therein.

8. CONTRACT INTERESTS BY COUNTY PUBLIC OFFICIALS

- A. In accordance with Wisconsin Statute 946.13, county official may not bid for or enter into any contract involving receipts or disbursements of more than \$15,000.00 in a year, in which they have private pecuniary interest, direct or indirect if at same time they are authorized to take official action with respect to making of this Contract. Any contract entered into in violation of this Statute is void and County incurs no liability thereon. This subsection does not affect application and enforcement of Wisconsin Statute 946.13 by state prosecutors in criminal courts of this state.

9. EMERGING SMALL BUSINESS PROVISIONS

- A. Not Applicable

10. METHOD OF AWARD - RESERVATIONS

- A. Following will be basis of award of Contract, providing cost does not exceed amount of funds then estimated by County as available to finance Contract(s):
 - 1. Lowest dollar amount submitted by qualified responsible bidder on Base Bid for all work comprising project, combined with such additive Owner accepted alternates.
 - 2. Owner reserves right to reject all bids or any bid, to waive any informality in any bid, and to accept any bid that will best serve interests of County.
 - 3. Unit Prices and Informational Bids will not be considered in establishing low bidder.

11. SECURITY FOR PERFORMANCE AND PAYMENTS

- A. Simultaneous with delivery of signed Contract, Bidder shall be required to furnish Performance and Payment Bonds as specified in Article 29 of General Conditions of Contract, "Contract Security",. Surety Company shall be licensed to do business in Wisconsin. Performance and Payment Bonds must be dated same date or subsequent to date of Contract. Performance and Payment Bonds must emulate information in Sample Performance and Payment Bonds in Construction Documents.
- B. Provide certified copy of power of attorney from Surety Company showing that agent who signs Bond has power of attorney to sign for Surety Company. Secretary or Assistant Secretary of company must sign this certification, not attorney-in-fact. Certification must bear same or later date as Bond. Power of Attorney must emulate model power of attorney information detailed in Sample Performance and Payment Bonds.
- C. If Bidder is partnership or joint venture, State certified list, providing names of individuals constituting partnership or joint venture must be furnished. Contract itself may be signed by one partner of partnership, or one partner of each firm comprising joint venture, but Performance and Payment Bonds must be signed by all partners.
- D. If Bidder is corporation, it is necessary that current certified copy of resolution or other official act of directors of corporation be submitted showing that person who signs Contract is authorized to sign contracts for corporation. It is also necessary that corporate seal be affixed to resolution, contract, and performance and payment bonds. If your corporation has no seal, it is required that above documents include statement or notation to effect that corporation has no seal.

12. TAXES

- A. Wisconsin Statute 77.54 (9m) allows building materials that become part of local unit government facilities to be exempt from sales & use tax. Vendors & materials suppliers may not charge Bidders sales & use tax on these purchases. This does not include highways, streets or roads. Any other Sales, Consumer, Use & other similar taxes or fees required by law shall be included in Bid.
- B. In accordance with Wisconsin Statute 71.80(16)(a), successful nonresident bidder, whether incorporated or not, and not otherwise regularly engaged in business in this state, shall file surety bond with State of Wisconsin Department of Revenue payable to Department of Revenue, to guarantee payment of income taxes, required unemployment compensation contributions, sales and use taxes and income taxes withheld from wages of employees, together with any penalties and interest thereon. Amount of bond shall be three percent (3%) of Contract or subcontract price on all contracts of \$50,000 or more.

13. SUBMISSION OF BIDS

- A. All Bids shall be submitted on standard Bid Form bound herein and only Bids that are made on this Bid Form will be considered. Entire Bid Form and other supporting documents, if any, shall be removed or copied from Construction Documents, filled out, and submitted in manner specified hereinafter. Submit completed Bid Bond with Bid as well.
- B. No bids for any subdivision or any sub-classification of this Work, except as indicated, will be accepted. Any conditional Bid, amendment to Bid Form or appended item thereto, or inclusion of any correspondence, written or printed matter, or details of any nature other than that specifically called for, which would alter any essential provision of Construction Documents, or require consideration of unsolicited material or data in determining award of Contract, will disqualify Bid. Telecommunication alterations to Bid will not be accepted.
- C. Bidders must submit single Bid for all the Work.
- D. Bid amounts shall be inserted in words and in figures in spaces provided on Bid Form; in case of conflict, written word amounts will govern.
- E. Addenda issued after Bid Letting shall become part of Construction Documents. Bidders shall acknowledge receipt of such addenda in appropriate space provided on Bid Form. Bid may be rejected if receipt of any particular addendum applicable to award of Contract has not been acknowledged on Bid Form.
- F. Bids shall be signed, placed in envelope, sealed and delivered before due time to place designated in Invitation to Bid, and identified with project name, bid number, location, category of work being bid upon, Bid Due Date, name and address of bidder.
- G. Bidder shall be responsible for sealed Bid being delivered to place designated for Bid Due Date on or before date and time specified. Bids received after time of closing will be rejected and returned to bidder unopened.
- H. Bid will be considered invalid and will be rejected if bidder has not signed it.
- I. Faxed or emailed Bids will not be accepted.
- J. Bidder's organization shall submit completed with Bid, Fair Labor Practices Certification form, included in these Construction Documents.

14. SUBCONTRACTOR LISTING

- A. Bidders shall be required to submit list of major subcontractors for General Construction, Plumbing, HVAC, and Electrical work proposed for this project to include committed prices for each subcontractor. . County must receive subcontractor list no later than date by which successful Bidder is required to submit his or her signed Contract, as established in Construction Documents.

15. ALTERNATE BIDS

- A. Not Applicable.

16. INFORMATIONAL BIDS

- A. Not Applicable.

17. UNIT PRICES

- A. Not Applicable.

18. COMMENCEMENT AND COMPLETION

- A. Successful Bidder shall commence work when schedule and weather permit, but no later than stated in Bid Form. Contractor shall pursue the Work regularly and continuously at reasonable rate to insure completion of the Work within time stated in Bid.
- B. Should it be found impossible to complete the Work on or before time specified for completion, written request may be submitted for extension of time setting forth reasons believed to justify granting of such request. Refer to Article 20 of General Conditions of Contract, titled "Time for Completion".

19. WORK BY OWNER

- A. This work will be accomplished by Owner or will be let under separate contracts and will not be included under this Contract:
 - 1. Sawcutting, trenching and backfill for piping.
 - 2. Electrical work and connections.

20. SPECIAL HAZARDS COVERAGE

- A. Not Applicable.

Name of Bidding Firm: _____

SECTION 00 41 13

BID FORM

BID NO. 320037

**PROJECT: FUELING FACILITY UPGRADES
HIGHWAY DEPT. - EAST DISTRICT CAMPUS**

**TO: DANE COUNTY DEPARTMENT OF PUBLIC WORKS, HIGHWAY &
TRANSPORTATION, PROJECT MANAGER
1919 ALLIANT ENERGY CENTER WAY
MADISON, WISCONSIN 53713**

**NOTE: WISCONSIN STATUTE 77.54 (9M) ALLOWS FOR NO SALES & USE TAX ON
THE PURCHASE OF MATERIALS FOR COUNTY PUBLIC WORKS PROJECTS.**

BASE BID - LUMP SUM:

Contractor to provide mechanical piping and high pressure tubing for a new compressed natural gas (CNG) system.. The undersigned, having examined the site where the Work is to be executed and having become familiar with local conditions affecting the cost of the Work and having carefully examined the Drawings and Specifications, all other Construction Documents and Addenda thereto prepared by Dane County Department of Public Works, Highway & Transportation hereby agrees to provide all labor, materials, equipment and services necessary for the complete and satisfactory execution of the entire Work, as specified in the Construction Documents, for the Base Bid stipulated sum of:

_____ and __/100 Dollars
Written Price

\$ _____
Numeric Price

Receipt of the following addenda and inclusion of their provisions in this Bid is hereby acknowledged:

Addendum No(s). _____ through _____

Dated _____

Dane County Public Works, Highway & Transportation must have this project completed by January 22, 2021. Assuming this Work can be started by December 1, 2020, what dates can you commence and complete this job?

Commencement Date: _____ Completion Date: _____
(final, not substantial)

I hereby certify that all statements herein are made on behalf of:

(Name of Corporation, Partnership or Person submitting Bid)

Select one of the following:

1. A corporation organized and existing under the laws of the State of _____, or
2. A partnership consisting of _____, or
3. A person conducting business as _____;

Of the City, Village, or Town of _____ of the State of _____.

I have examined and carefully prepared this Bid from the associated Construction Documents and have checked the same in detail before submitting this Bid; that I have full authority to make such statements and submit this Bid in (its) (their) (my) behalf; and that the said statements are true and correct. In signing this Bid, we also certify that we have not, either directly or indirectly, entered into any agreement or participated in any collusion or otherwise taken any action in restraint of free competition; that no attempt has been made to induce any other person or firm to submit or not to submit a Bid; that this Bid has been independently arrived at without collusion with any other bidder, competitor, or potential competitor; that this Bid has not been knowingly disclosed prior to the Bids Due Date to another bidder or competitor; that the above statement is accurate under penalty of perjury.

The undersigned is qualified as a Best Value Contractor or has proven their exemption. Qualification or exemption shall be complete before Bid Due Date / Time.

The undersigned further agrees to honor the Base Bid and the Alternate Bid(s) for sixty (60) calendar days from date of Award of Contract.

SIGNATURE: _____
(Bid is invalid without signature)

Print Name: _____ Date: _____

Title: _____

Address: _____

Telephone No.: _____ Fax No.: _____

Email Address: _____

Contact Person: _____

END OF SECTION

THIS PAGE IS FOR BIDDERS' REFERENCE
DO NOT SUBMIT WITH BID FORM.

BID CHECK LIST:

These items **must** be included with Bid:

Bid Form

Bid Bond

Fair Labor Practices Certification

DANE COUNTY BEST VALUE CONTRACTING QUALIFICATION

General Contractors & all Subcontractors must be qualified as a Best Value Contractor with the Dane County Public Works Engineering Division. Qualification & listing is not permanent & must be renewed every 24 months. Complete a *Best Value Contracting Application* online at:

pwht.countyofdane.com/bvc_application.aspx

DANE COUNTY VENDOR REGISTRATION PROGRAM

All bidders are strongly encouraged to be a registered vendor with Dane County. Registering allows vendors an opportunity to receive notifications for RFBs & RFPs issued by the County and provides the County with up-to-date company contact information. Complete a new form or renewal online at:

danepurchasing.com/Account/Login?

COUNTY OF DANE

PUBLIC WORKS CONSTRUCTION CONTRACT

Contract No. _____ Bid No. 320037

Authority: 2020 RES - _____

THIS CONTRACT, made and entered into as of the date by which authorized representatives of both parties have affixed their signatures, by and between the County of Dane (hereafter referred to as "COUNTY") and _____ (hereafter, "CONTRACTOR"), and

WITNESSETH:

WHEREAS, COUNTY, whose address is c/o Deputy Public Works Director, 1919 Alliant Energy Center Way, Madison, WI 53713, desires to have CONTRACTOR provide Fueling Facility Upgrades at the Highway Department - East District Campus ("the Project"); and

WHEREAS, CONTRACTOR, whose address is _____ is able and willing to construct the Project, in accordance with the Construction Documents;

NOW, THEREFORE, in consideration of the above premises and the mutual covenants of the parties hereinafter set forth, the receipt and sufficiency of which is acknowledged by each party for itself, COUNTY and CONTRACTOR do agree as follows:

1. CONTRACTOR agrees to construct, for the price of \$_____ the Project and at the CONTRACTOR'S own proper cost and expense to furnish all materials, supplies, machinery, equipment, tools, superintendence labor, insurance, and other accessories and services necessary to complete the Project in accordance with the conditions and prices stated in the Bid Form, General Conditions of Contract, the drawings which include all maps, plats, plans, and other drawings and printed or written explanatory matter thereof, and the specifications therefore as prepared by _____ (hereinafter referred to as "the Architect / Engineer"), and as enumerated in the Project Manual Table of Contents, all of which are made a part hereof and collectively evidence and constitute the Contract.

2. COUNTY agrees to pay the CONTRACTOR in current funds for the performance of the Contract subject to additions and deductions, as provided in the General Conditions of Contract, and to make payments on account thereof as provided in Article entitled, "Payments to Contractor" of the General Conditions of Contract.

3. During the term of this Contract, CONTRACTOR agrees to take affirmative action to ensure equal employment opportunities. The CONTRACTOR agrees in accordance with Wisconsin Statute 111.321 and Chapter 19 of the Dane County Code of Ordinances not to discriminate on the basis of age, race, ethnicity, religion, color, gender, disability, marital status, sexual orientation, national origin, cultural differences, ancestry, physical appearance, arrest record or conviction record, military participation or membership in the national guard, state defense force or any other reserve component of the military forces of the United States, or political beliefs.

Such equal opportunity shall include, but not be limited to, the following: employment, upgrading, demotion, transfer, recruitment, advertising, layoff, termination, training, rates of pay, and any other form of compensation. CONTRACTOR agrees to post in conspicuous places, available to all employees and applicants for employment, notices setting forth the provisions of this paragraph.

4. CONTRACTOR shall file an Affirmative Action Plan with the Dane County Contract Compliance Specialist in accord with Chapter 19 of the Dane County Code of Ordinances. CONTRACTOR must file such plan within fifteen (15) business days of the effective date of this Contract. During the term of this Contract CONTRACTOR shall also provide copies of all announcements of employment opportunities to COUNTY'S Office of Equity & Inclusion, and shall report annually the number of persons, by race, ethnicity, gender, and disability status, which apply for employment and, similarly classified, the number hired and number rejected.

5. During the term of this Contract, all solicitations for employment placed on CONTRACTOR'S behalf shall include a statement to the effect that CONTRACTOR is an "Equal Opportunity Employer".

6. CONTRACTOR agrees to furnish all information and reports required by COUNTY'S Contract Compliance Specialist as the same relate to affirmative action and nondiscrimination, which may include any books, records, or accounts deemed appropriate to determine compliance with Chapter 19, Dane County Code of Ordinances, and the provisions of this Contract.

7. This Contract is intended to be a Contract solely between the parties hereto and for their benefit only. No part of this Contract shall be construed to add to, supplement, amend, abridge or repeal existing rights, benefits or privileges of any third party or parties including, but not limited to, employees of either of the parties.

8. The entire agreement of the parties is contained herein and this Contract supersedes any and all oral agreements and negotiations between the parties relating to the subject matter hereof. The parties expressly agree that the express terms of this Contract shall not be amended in any fashion except in writing, executed by both parties.

9. CONTRACTOR must be qualified as a Best Value Contractor or have proven their exemption with Dane County Public Works Engineering Division before Bid Due Date / Time. All contractors and subcontractors must be qualified as a Best Value Contractor or have proven their exemption to perform any work under this Contract.

IN WITNESS WHEREOF, COUNTY and CONTRACTOR, by their respective authorized agents, have caused this Contract and its Schedules to be executed, effective as of the date by which all parties hereto have affixed their respective signatures, as indicated below.

* * * * *

FOR CONTRACTOR:

Signature Date

Printed or Typed Name and Title

Signature Date

Printed or Typed Name and Title

NOTE: If CONTRACTOR is a corporation, Secretary should attest. In accordance with IRS Regulations, unincorporated entities are required to provide either their Social Security or Employer Number in order to receive payment for services rendered.

* * * * *

This Contract is not valid or effectual for any purpose until approved by the appropriate authority designated below, and no work is authorized until the CONTRACTOR has been given notice to proceed by COUNTY'S Deputy Public Works Director.

FOR COUNTY:

Joseph T. Parisi, County Executive Date

Scott McDonell, County Clerk Date

AIA[®] Document A310[™] – 2010

Bid Bond

CONTRACTOR:

(Name, legal status and address)

SURETY:

(Name, legal status and principal place of business)

OWNER:

(Name, legal status and address)

BOND AMOUNT:**PROJECT:**

(Name, location or address, and Project number, if any)

This document has important legal consequences. Consultation with an attorney is encouraged with respect to its completion or modification.

Any singular reference to Contractor, Surety, Owner or other party shall be considered plural where applicable.

The Contractor and Surety are bound to the Owner in the amount set forth above, for the payment of which the Contractor and Surety bind themselves, their heirs, executors, administrators, successors and assigns, jointly and severally, as provided herein. The conditions of this Bond are such that if the Owner accepts the bid of the Contractor within the time specified in the bid documents, or within such time period as may be agreed to by the Owner and Contractor, and the Contractor either (1) enters into a contract with the Owner in accordance with the terms of such bid, and gives such bond or bonds as may be specified in the bidding or Contract Documents, with a surety admitted in the jurisdiction of the Project and otherwise acceptable to the Owner, for the faithful performance of such Contract and for the prompt payment of labor and material furnished in the prosecution thereof; or (2) pays to the Owner the difference, not to exceed the amount of this Bond, between the amount specified in said bid and such larger amount for which the Owner may in good faith contract with another party to perform the work covered by said bid, then this obligation shall be null and void, otherwise to remain in full force and effect. The Surety hereby waives any notice of an agreement between the Owner and Contractor to extend the time in which the Owner may accept the bid. Waiver of notice by the Surety shall not apply to any extension exceeding sixty (60) days in the aggregate beyond the time for acceptance of bids specified in the bid documents, and the Owner and Contractor shall obtain the Surety's consent for an extension beyond sixty (60) days.

If this Bond is issued in connection with a subcontractor's bid to a Contractor, the term Contractor in this Bond shall be deemed to be Subcontractor and the term Owner shall be deemed to be Contractor.

When this Bond has been furnished to comply with a statutory or other legal requirement in the location of the Project, any provision in this Bond conflicting with said statutory or legal requirement shall be deemed deleted herefrom and provisions conforming to such statutory or other legal requirement shall be deemed incorporated herein. When so furnished, the intent is that this Bond shall be construed as a statutory bond and not as a common law bond.

Signed and sealed this _____ day of _____

_____	(Contractor as Principal)	_____	(Seal)
(Witness)	_____	_____	(Title)
_____	(Surety)	_____	(Seal)
(Witness)	_____	_____	(Title)

CAUTION: You should sign an original AIA Contract Document, on which this text appears in RED. An original assures that changes will not be obscured.

AIA[®] Document A312[™] – 2010

Performance Bond

CONTRACTOR:

(Name, legal status and address)

SURETY:

(Name, legal status and principal place of business)

OWNER:

(Name, legal status and address)

CONSTRUCTION CONTRACT

Date:

Amount:

Description:

(Name and location)

BOND

Date:

(Not earlier than Construction Contract Date)

Amount:

Modifications to this Bond: None See Section 16

CONTRACTOR AS PRINCIPAL

Company: *(Corporate Seal)*

SURETY

Company: *(Corporate Seal)*

Signature: _____

Name _____
and Title: _____

(Any additional signatures appear on the last page of this Performance Bond.)

Signature: _____

Name _____
and Title: _____

(FOR INFORMATION ONLY — Name, address and telephone)

AGENT or BROKER:

OWNER'S REPRESENTATIVE:

(Architect, Engineer or other party:)

This document has important legal consequences. Consultation with an attorney is encouraged with respect to its completion or modification.

Any singular reference to Contractor, Surety, Owner or other party shall be considered plural where applicable.

AIA Document A312–2010 combines two separate bonds, a Performance Bond and a Payment Bond, into one form. This is not a single combined Performance and Payment Bond.

§ 1 The Contractor and Surety, jointly and severally, bind themselves, their heirs, executors, administrators, successors and assigns to the Owner for the performance of the Construction Contract, which is incorporated herein by reference.

§ 2 If the Contractor performs the Construction Contract, the Surety and the Contractor shall have no obligation under this Bond, except when applicable to participate in a conference as provided in Section 3.

§ 3 If there is no Owner Default under the Construction Contract, the Surety's obligation under this Bond shall arise after

- .1 the Owner first provides notice to the Contractor and the Surety that the Owner is considering declaring a Contractor Default. Such notice shall indicate whether the Owner is requesting a conference among the Owner, Contractor and Surety to discuss the Contractor's performance. If the Owner does not request a conference, the Surety may, within five (5) business days after receipt of the Owner's notice, request such a conference. If the Surety timely requests a conference, the Owner shall attend. Unless the Owner agrees otherwise, any conference requested under this Section 3.1 shall be held within ten (10) business days of the Surety's receipt of the Owner's notice. If the Owner, the Contractor and the Surety agree, the Contractor shall be allowed a reasonable time to perform the Construction Contract, but such an agreement shall not waive the Owner's right, if any, subsequently to declare a Contractor Default;
- .2 the Owner declares a Contractor Default, terminates the Construction Contract and notifies the Surety; and
- .3 the Owner has agreed to pay the Balance of the Contract Price in accordance with the terms of the Construction Contract to the Surety or to a contractor selected to perform the Construction Contract.

§ 4 Failure on the part of the Owner to comply with the notice requirement in Section 3.1 shall not constitute a failure to comply with a condition precedent to the Surety's obligations, or release the Surety from its obligations, except to the extent the Surety demonstrates actual prejudice.

§ 5 When the Owner has satisfied the conditions of Section 3, the Surety shall promptly and at the Surety's expense take one of the following actions:

§ 5.1 Arrange for the Contractor, with the consent of the Owner, to perform and complete the Construction Contract;

§ 5.2 Undertake to perform and complete the Construction Contract itself, through its agents or independent contractors;

§ 5.3 Obtain bids or negotiated proposals from qualified contractors acceptable to the Owner for a contract for performance and completion of the Construction Contract, arrange for a contract to be prepared for execution by the Owner and a contractor selected with the Owner's concurrence, to be secured with performance and payment bonds executed by a qualified surety equivalent to the bonds issued on the Construction Contract, and pay to the Owner the amount of damages as described in Section 7 in excess of the Balance of the Contract Price incurred by the Owner as a result of the Contractor Default; or

§ 5.4 Waive its right to perform and complete, arrange for completion, or obtain a new contractor and with reasonable promptness under the circumstances:

- .1 After investigation, determine the amount for which it may be liable to the Owner and, as soon as practicable after the amount is determined, make payment to the Owner; or
- .2 Deny liability in whole or in part and notify the Owner, citing the reasons for denial.

§ 6 If the Surety does not proceed as provided in Section 5 with reasonable promptness, the Surety shall be deemed to be in default on this Bond seven days after receipt of an additional written notice from the Owner to the Surety demanding that the Surety perform its obligations under this Bond, and the Owner shall be entitled to enforce any remedy available to the Owner. If the Surety proceeds as provided in Section 5.4, and the Owner refuses the payment or the Surety has denied liability, in whole or in part, without further notice the Owner shall be entitled to enforce any remedy available to the Owner.

§ 7 If the Surety elects to act under Section 5.1, 5.2 or 5.3, then the responsibilities of the Surety to the Owner shall not be greater than those of the Contractor under the Construction Contract, and the responsibilities of the Owner to the Surety shall not be greater than those of the Owner under the Construction Contract. Subject to the commitment by the Owner to pay the Balance of the Contract Price, the Surety is obligated, without duplication, for

- .1 the responsibilities of the Contractor for correction of defective work and completion of the Construction Contract;
- .2 additional legal, design professional and delay costs resulting from the Contractor's Default, and resulting from the actions or failure to act of the Surety under Section 5; and
- .3 liquidated damages, or if no liquidated damages are specified in the Construction Contract, actual damages caused by delayed performance or non-performance of the Contractor.

§ 8 If the Surety elects to act under Section 5.1, 5.3 or 5.4, the Surety's liability is limited to the amount of this Bond.

§ 9 The Surety shall not be liable to the Owner or others for obligations of the Contractor that are unrelated to the Construction Contract, and the Balance of the Contract Price shall not be reduced or set off on account of any such unrelated obligations. No right of action shall accrue on this Bond to any person or entity other than the Owner or its heirs, executors, administrators, successors and assigns.

§ 10 The Surety hereby waives notice of any change, including changes of time, to the Construction Contract or to related subcontracts, purchase orders and other obligations.

§ 11 Any proceeding, legal or equitable, under this Bond may be instituted in any court of competent jurisdiction in the location in which the work or part of the work is located and shall be instituted within two years after a declaration of Contractor Default or within two years after the Contractor ceased working or within two years after the Surety refuses or fails to perform its obligations under this Bond, whichever occurs first. If the provisions of this Paragraph are void or prohibited by law, the minimum period of limitation available to sureties as a defense in the jurisdiction of the suit shall be applicable.

§ 12 Notice to the Surety, the Owner or the Contractor shall be mailed or delivered to the address shown on the page on which their signature appears.

§ 13 When this Bond has been furnished to comply with a statutory or other legal requirement in the location where the construction was to be performed, any provision in this Bond conflicting with said statutory or legal requirement shall be deemed deleted herefrom and provisions conforming to such statutory or other legal requirement shall be deemed incorporated herein. When so furnished, the intent is that this Bond shall be construed as a statutory bond and not as a common law bond.

§ 14 Definitions

§ 14.1 **Balance of the Contract Price.** The total amount payable by the Owner to the Contractor under the Construction Contract after all proper adjustments have been made, including allowance to the Contractor of any amounts received or to be received by the Owner in settlement of insurance or other claims for damages to which the Contractor is entitled, reduced by all valid and proper payments made to or on behalf of the Contractor under the Construction Contract.

§ 14.2 **Construction Contract.** The agreement between the Owner and Contractor identified on the cover page, including all Contract Documents and changes made to the agreement and the Contract Documents.

§ 14.3 **Contractor Default.** Failure of the Contractor, which has not been remedied or waived, to perform or otherwise to comply with a material term of the Construction Contract.

§ 14.4 **Owner Default.** Failure of the Owner, which has not been remedied or waived, to pay the Contractor as required under the Construction Contract or to perform and complete or comply with the other material terms of the Construction Contract.

§ 14.5 **Contract Documents.** All the documents that comprise the agreement between the Owner and Contractor.

§ 15 If this Bond is issued for an agreement between a Contractor and subcontractor, the term Contractor in this Bond shall be deemed to be Subcontractor and the term Owner shall be deemed to be Contractor.

§ 16 Modifications to this bond are as follows:

Sample

(Space is provided below for additional signatures of added parties, other than those appearing on the cover page.)

CONTRACTOR AS PRINCIPAL

SURETY

Company: _____

(Corporate Seal)

Company: _____

(Corporate Seal)

Signature: _____

Name and Title: _____

Address _____

Signature: _____

Name and Title: _____

Address _____

CAUTION: You should sign an original AIA Contract Document, on which this text appears in RED. An original assures that changes will not be obscured.



AIA® Document A312™ – 2010

Payment Bond

CONTRACTOR:

(Name, legal status and address)

SURETY:

(Name, legal status and principal place of business)

OWNER:

(Name, legal status and address)

This document has important legal consequences. Consultation with an attorney is encouraged with respect to its completion or modification.

Any singular reference to Contractor, Surety, Owner or other party shall be considered plural where applicable.

AIA Document A312–2010 combines two separate bonds, a Performance Bond and a Payment Bond, into one form. This is not a single combined Performance and Payment Bond.

CONSTRUCTION CONTRACT

Date:

Amount:

Description:

(Name and location)

BOND

Date:

(Not earlier than Construction Contract Date)

Amount:

Modifications to this Bond: None See Section 18

CONTRACTOR AS PRINCIPAL

Company: *(Corporate Seal)*

SURETY

Company: *(Corporate Seal)*

Signature: _____

Name _____
and Title: _____

Signature: _____

Name _____
and Title: _____

(Any additional signatures appear on the last page of this Payment Bond.)

(FOR INFORMATION ONLY — Name, address and telephone)

AGENT or BROKER:**OWNER'S REPRESENTATIVE:**

(Architect, Engineer or other party:)

§ 1 The Contractor and Surety, jointly and severally, bind themselves, their heirs, executors, administrators, successors and assigns to the Owner to pay for labor, materials and equipment furnished for use in the performance of the Construction Contract, which is incorporated herein by reference, subject to the following terms.

§ 2 If the Contractor promptly makes payment of all sums due to Claimants, and defends, indemnifies and holds harmless the Owner from claims, demands, liens or suits by any person or entity seeking payment for labor, materials or equipment furnished for use in the performance of the Construction Contract, then the Surety and the Contractor shall have no obligation under this Bond.

§ 3 If there is no Owner Default under the Construction Contract, the Surety's obligation to the Owner under this Bond shall arise after the Owner has promptly notified the Contractor and the Surety (at the address described in Section 13) of claims, demands, liens or suits against the Owner or the Owner's property by any person or entity seeking payment for labor, materials or equipment furnished for use in the performance of the Construction Contract and tendered defense of such claims, demands, liens or suits to the Contractor and the Surety.

§ 4 When the Owner has satisfied the conditions in Section 3, the Surety shall promptly and at the Surety's expense defend, indemnify and hold harmless the Owner against a duly tendered claim, demand, lien or suit.

§ 5 The Surety's obligations to a Claimant under this Bond shall arise after the following:

§ 5.1 Claimants, who do not have a direct contract with the Contractor,

- .1 have furnished a written notice of non-payment to the Contractor, stating with substantial accuracy the amount claimed and the name of the party to whom the materials were, or equipment was, furnished or supplied or for whom the labor was done or performed, within ninety (90) days after having last performed labor or last furnished materials or equipment included in the Claim; and
- .2 have sent a Claim to the Surety (at the address described in Section 13).

§ 5.2 Claimants, who are employed by or have a direct contract with the Contractor, have sent a Claim to the Surety (at the address described in Section 13).

§ 6 If a notice of non-payment required by Section 5.1.1 is given by the Owner to the Contractor, that is sufficient to satisfy a Claimant's obligation to furnish a written notice of non-payment under Section 5.1.1.

§ 7 When a Claimant has satisfied the conditions of Sections 5.1 or 5.2, whichever is applicable, the Surety shall promptly and at the Surety's expense take the following actions:

§ 7.1 Send an answer to the Claimant, with a copy to the Owner, within sixty (60) days after receipt of the Claim, stating the amounts that are undisputed and the basis for challenging any amounts that are disputed; and

§ 7.2 Pay or arrange for payment of any undisputed amounts.

§ 7.3 The Surety's failure to discharge its obligations under Section 7.1 or Section 7.2 shall not be deemed to constitute a waiver of defenses the Surety or Contractor may have or acquire as to a Claim, except as to undisputed amounts for which the Surety and Claimant have reached agreement. If, however, the Surety fails to discharge its obligations under Section 7.1 or Section 7.2, the Surety shall indemnify the Claimant for the reasonable attorney's fees the Claimant incurs thereafter to recover any sums found to be due and owing to the Claimant.

§ 8 The Surety's total obligation shall not exceed the amount of this Bond, plus the amount of reasonable attorney's fees provided under Section 7.3, and the amount of this Bond shall be credited for any payments made in good faith by the Surety.

§ 9 Amounts owed by the Owner to the Contractor under the Construction Contract shall be used for the performance of the Construction Contract and to satisfy claims, if any, under any construction performance bond. By the Contractor furnishing and the Owner accepting this Bond, they agree that all funds earned by the Contractor in the performance of the Construction Contract are dedicated to satisfy obligations of the Contractor and Surety under this Bond, subject to the Owner's priority to use the funds for the completion of the work.

§ 10 The Surety shall not be liable to the Owner, Claimants or others for obligations of the Contractor that are unrelated to the Construction Contract. The Owner shall not be liable for the payment of any costs or expenses of any Claimant under this Bond, and shall have under this Bond no obligation to make payments to, or give notice on behalf of, Claimants or otherwise have any obligations to Claimants under this Bond.

§ 11 The Surety hereby waives notice of any change, including changes of time, to the Construction Contract or to related subcontracts, purchase orders and other obligations.

§ 12 No suit or action shall be commenced by a Claimant under this Bond other than in a court of competent jurisdiction in the state in which the project that is the subject of the Construction Contract is located or after the expiration of one year from the date (1) on which the Claimant sent a Claim to the Surety pursuant to Section 5.1.2 or 5.2, or (2) on which the last labor or service was performed by anyone or the last materials or equipment were furnished by anyone under the Construction Contract, whichever of (1) or (2) first occurs. If the provisions of this Paragraph are void or prohibited by law, the minimum period of limitation available to sureties as a defense in the jurisdiction of the suit shall be applicable.

§ 13 Notice and Claims to the Surety, the Owner or the Contractor shall be mailed or delivered to the address shown on the page on which their signature appears. Actual receipt of notice or Claims, however accomplished, shall be sufficient compliance as of the date received.

§ 14 When this Bond has been furnished to comply with a statutory or other legal requirement in the location where the construction was to be performed, any provision in this Bond conflicting with said statutory or legal requirement shall be deemed deleted herefrom and provisions conforming to such statutory or other legal requirement shall be deemed incorporated herein. When so furnished, the intent is that this Bond shall be construed as a statutory bond and not as a common law bond.

§ 15 Upon request by any person or entity appearing to be a potential beneficiary of this Bond, the Contractor and Owner shall promptly furnish a copy of this Bond or shall permit a copy to be made.

§ 16 Definitions

§ 16.1 Claim. A written statement by the Claimant including at a minimum:

- .1 the name of the Claimant;
- .2 the name of the person for whom the labor was done, or materials or equipment furnished;
- .3 a copy of the agreement or purchase order pursuant to which labor, materials or equipment was furnished for use in the performance of the Construction Contract;
- .4 a brief description of the labor, materials or equipment furnished;
- .5 the date on which the Claimant last performed labor or last furnished materials or equipment for use in the performance of the Construction Contract;
- .6 the total amount earned by the Claimant for labor, materials or equipment furnished as of the date of the Claim;
- .7 the total amount of previous payments received by the Claimant; and
- .8 the total amount due and unpaid to the Claimant for labor, materials or equipment furnished as of the date of the Claim.

§ 16.2 Claimant. An individual or entity having a direct contract with the Contractor or with a subcontractor of the Contractor to furnish labor, materials or equipment for use in the performance of the Construction Contract. The term Claimant also includes any individual or entity that has rightfully asserted a claim under an applicable mechanic's lien or similar statute against the real property upon which the Project is located. The intent of this Bond shall be to include without limitation in the terms "labor, materials or equipment" that part of water, gas, power, light, heat, oil, gasoline, telephone service or rental equipment used in the Construction Contract, architectural and engineering services required for performance of the work of the Contractor and the Contractor's subcontractors, and all other items for which a mechanic's lien may be asserted in the jurisdiction where the labor, materials or equipment were furnished.

§ 16.3 Construction Contract. The agreement between the Owner and Contractor identified on the cover page, including all Contract Documents and all changes made to the agreement and the Contract Documents.

§ 16.4 **Owner Default.** Failure of the Owner, which has not been remedied or waived, to pay the Contractor as required under the Construction Contract or to perform and complete or comply with the other material terms of the Construction Contract.

§ 16.5 **Contract Documents.** All the documents that comprise the agreement between the Owner and Contractor.

§ 17 If this Bond is issued for an agreement between a Contractor and subcontractor, the term Contractor in this Bond shall be deemed to be Subcontractor and the term Owner shall be deemed to be Contractor.

§ 18 Modifications to this bond are as follows:

(Space is provided below for additional signatures of added parties, other than those appearing on the cover page.)

CONTRACTOR AS PRINCIPAL

Company: _____

(Corporate Seal)

SURETY

Company: _____

(Corporate Seal)

Signature: _____

Name and Title: _____

Address _____

Signature: _____

Name and Title: _____

Address _____

CAUTION: You should sign an original AIA Contract Document, on which this text appears in RED. An original assures that changes will not be obscured.

SECTION 00 72 12

GENERAL CONDITIONS OF CONTRACT

TABLE OF CONTENTS

1. CONSTRUCTION DOCUMENTS2
2. DEFINITIONS2
3. ADDITIONAL INSTRUCTIONS AND DRAWINGS2
4. SHOP DRAWINGS, PRODUCT DATA AND SAMPLES3
5. CUTTING AND PATCHING.....3
6. CLEANING UP4
7. USE OF SITE.....4
8. MATERIALS AND WORKMANSHIP5
9. CONTRACTOR’S TITLE TO MATERIALS5
10. “OR EQUAL” CLAUSE.....5
11. PATENTS AND ROYALTIES.....6
12. SURVEYS, PERMITS, REGULATIONS AND TAXES.....6
13. CONTRACTOR’S OBLIGATIONS AND SUPERINTENDENCE.....7
14. WEATHER CONDITIONS8
15. PROTECTION OF WORK AND PROPERTY8
16. INSPECTION AND TESTING OF MATERIALS8
17. REPORTS, RECORDS AND DATA9
18. CHANGES IN THE WORK9
19. EXTRAS10
20. TIME FOR COMPLETION.....10
21. CORRECTION OF WORK10
22. SUBSURFACE CONDITIONS FOUND DIFFERENT10
23. RIGHT OF DEPARTMENT TO TERMINATE CONTRACT11
24. CONSTRUCTION SCHEDULE AND PERIODIC ESTIMATES11
25. PAYMENTS TO CONTRACTOR12
26. WITHHOLDING OF PAYMENTS13
27. ACCEPTANCE OF FINAL PAYMENT AS RELEASE14
28. PAYMENTS BY CONTRACTOR14
29. CONTRACT SECURITY14
30. ASSIGNMENTS14
31. MUTUAL RESPONSIBILITY OF CONTRACTORS14
32. SEPARATE CONTRACTS15
33. SUBCONTRACTS15
34. PROJECT MANAGER’S AUTHORITY16
35. CONSULTANT’S AUTHORITY16
36. STATED ALLOWANCES16
37. ESTIMATES OF QUANTITIES17
38. LANDS AND RIGHTS-OF-WAY17
39. GENERAL GUARANTEE17
40. CONFLICTING CONDITIONS17
41. NOTICE AND SERVICE THEREOF18
42. PROTECTION OF LIVES AND HEALTH18
43. AFFIRMATIVE ACTION PROVISION AND MINORITY / WOMEN /
DISADVANTAGED BUSINESS ENTERPRISES18
44. COMPLIANCE WITH FAIR LABOR STANDARDS19
45. DOMESTIC PARTNERSHIP BENEFITS19
46. USE AND OCCUPANCY PRIOR TO ACCEPTANCE19
47. MINIMUM WAGES19
48. CLAIMS20
49. ANTITRUST AGREEMENT20
50. INSURANCE.....20
51. WISCONSIN LAW CONTROLLING22

1. CONSTRUCTION DOCUMENTS

- A. Construction Documents, listed in Table of Contents of this Specification volume shall form part of this Contract and provisions of Construction Documents shall be as binding upon parties as if they were fully set forth in Contract itself.
- B. These shall also be considered as part of Construction Documents: Addenda, including additions and modifications incorporated in such addenda before execution of Contract; requests for information; construction bulletins; change orders; and written interpretations by Architect / Engineer or Public Works Project Manager that are made after execution of Contract.
- C. Construction Documents are complementary, and what is required by one shall be as binding as if required by all. Intent of Construction Documents is to include all labor, materials and equipment necessary for proper execution of the Work.

2. DEFINITIONS

- A. These terms as used in this Contract are respectively defined as follows:
 - 1. All uses of term “County” in Construction Documents shall mean Dane County.
 - 2. All uses of term “Department” in Construction Documents shall mean Department of Public Works, Highway & Transportation, which is a unit of Dane County government. Department is County agency overseeing Contract with Contractor.
 - 3. Public Works Project Manager is appointed by and responsible to Department. Public Works Project Manager has authority to act on behalf of Department and will sign change orders, payment requests and other administrative matters related to projects.
 - 4. Public Works Project Manager is responsible for supervision, administration and management of field operations involved in construction phase of this Work.
 - 5. Term “Work” includes all labor, equipment and materials necessary to produce project required by Construction Documents.
 - 6. Term “Substantial Completion” is date when project or specified area of project is certified by Architect / Engineer that construction is sufficiently completed, in accordance with Construction Documents, and as modified by any subsequent changes agreed to by parties, so that County may occupy project or specified area of project for use for which it was intended subject to permit approval for occupancy.
 - 7. Contractor is person, firm, or corporation with whom County makes Contract. Though multiple contracts may be involved, Construction Documents treat them throughout as if each were of singular number.

3. ADDITIONAL INSTRUCTIONS AND DRAWINGS

- A. Contractor may be furnished additional instructions and detail drawings as necessary to carry out the Work included in Contract. Additional drawings and instructions thus supplied to Contractor will coordinate with Construction Documents and will be so prepared that they can be reasonably interpreted as part thereof. Contractor shall carry out the Work in accordance with additional detail drawings and instructions.

4. SHOP DRAWINGS, PRODUCT DATA AND SAMPLES

- A. Unless otherwise specified, Contractor shall submit three (3) copies of all Shop Drawings for each submission, until receiving final approval. After final approval, provide five (5) additional copies for distribution and such other copies as may be required.
- B. Contractor shall submit, on an on-going basis and as directed, Product Data such as brochures that shall contain catalog cuts and specifications of all furnished mechanical and electrical equipment. After Architect / Engineer's approval, one (1) copy shall remain in Architect / Engineer's file, one (1) kept at Department's office and one (1) kept at job site by Contractor for reference purposes.
- C. Samples shall consist of physical examples furnished by Contractor in sufficient size and quantity to illustrate materials, equipment or workmanship, and to establish standards to compare the Work.
 - 1. Submit Samples in sufficient quantity (minimum of two (2)) to permit Architect / Engineer to make all necessary tests and of adequate size showing quality, type, color range, finish, and texture. Label each Sample stating material, type, color, thickness, size, project name, and Contractor's name.
 - 2. Submit transmittal letter requesting approval, and prepay transportation charges to Architect / Engineer's office on samples forwarded.
 - 3. Materials installed shall match approved Samples.
- D. Contractor shall review Shop Drawings and place their dated stamp thereon to evidence their review and approval and shall submit with reasonable promptness and in orderly sequence to cause no delay in the Work or in work of any other contractor. At time of submission, Contractor shall inform Architect / Engineer in writing of any deviation in Shop Drawings or Samples from requirements of Construction Documents. Architect / Engineer will not consider partial lists.
- E. Architect / Engineer will review and approve or reject Shop Drawings with reasonable promptness to cause no delay. Architect / Engineer's approval shall not relieve Contractor from responsibility for errors or omissions in Shop Drawings.
- F. Contractor shall not commence any work requiring Shop Drawing, Product Data or Sample submission until Architect / Engineer has approved submission. All such work shall be in accordance with approved Shop Drawings, Product Data and Samples.
- G. Contractor shall keep on site of the Work, approved or conformed copy of Shop Drawings and shall at all times give Department access thereto.
- H. By stamping and submitting Shop Drawings, Product Data and Samples, Contractor thereby represents that he or she has or will determine and verify all field measurements, field construction criteria, materials, catalog numbers, and similar data and that he or she has checked and coordinated each Shop Drawing, Product Data and Sample with requirements of the Work and of Construction Documents. Architect / Engineer shall return without examination, Shop Drawings, Product Data and Samples not so noted.
- I. All Shop Drawings from any one Contractor should be numbered consecutively and on cover sheet shall bear name and location of project, name of Contractor, date of submittal and date of each correction or revision and associated Specification section and page number.

5. CUTTING AND PATCHING

- A. Contractor shall be responsible for all cutting, fitting or patching required to complete the Work or to make its parts fit together properly.
- B. Contractor shall not damage or endanger portion of the Work or fully or partially completed construction of County or separate contractors by cutting, patching or otherwise altering such construction, or by excavation. Contractor shall not cut or otherwise alter such construction by County or separate contractor except with written consent of County and of such separate contractor; such consent shall not be unreasonably withheld. Contractor shall not withhold unreasonably from County or separate contractor, Contractor's consent to cutting or otherwise altering the Work.

6. CLEANING UP

- A. Contractor shall keep premises and surrounding area free from accumulation of waste materials or rubbish caused by operations under Contract. Contractor shall remove from and about the Work waste materials, rubbish, Contractor's tools, construction equipment, machinery, and surplus materials at completion of the Work. Contractor shall maintain streets and sidewalks around the Work site in clean condition. Contractor shall remove all spillage and prevent tracking of spillage arising from performance of the Work, into, out of, and within the Work site. Contractor shall establish regular maintenance program of sweeping, vacuuming and / or hosing to minimize accumulation of dirt and dust upon such areas.
- B. If Contractor fails to clean up as directed in Construction Documents, County may do so and shall charge Contractor cost thereof.
- C. Contractor shall be responsible for broken windows and glass, and at completion of the Work shall replace such damaged or broken windows and glass. After replacing damaged or broken windows and glass, Contractor shall remove all labels, wash and polish both sides of all windows and glass.
- D. In addition to general cleaning (sweeping, vacuuming and / or hosing, as is appropriate to work surface), Contractor shall perform following final cleaning for all trades at completion of the Work:
 - 1. Remove temporary protections;
 - 2. Remove marks, stains, fingerprints and other soil or dirt from painted, decorated and finished woodwork and wall surfaces;
 - 3. Remove spots, plaster, soil and paint from ceramic tile, marble and other finished materials, and wash or wipe clean;
 - 4. Clean fixtures, cabinet work and equipment, removing stains, paint, dirt and dust, and leave same in undamaged, new condition;
 - 5. Clean aluminum in accordance with recommendations of manufacturer; and
 - 6. Clean resilient floors thoroughly with well-rinsed mop containing only enough moisture to clean off any surface dirt or dust and buff dry by machine to bring surfaces to sheen.

7. USE OF SITE

- A. Contractor shall provide County and Architect / Engineer access to the Work under all circumstances.
- B. Contractor shall confine operations at site to areas permitted by County, law, ordinance, permits and Construction Documents and shall not unreasonably encumber site with materials

or equipment. Contractor shall assure free, convenient, unencumbered, direct and safe access to all properties adjacent to the Work for County, its employees, invitees and guests.

8. MATERIALS AND WORKMANSHIP

- A. Contractor shall perform all work and furnish all supplies and materials, machinery, equipment, facilities and means, necessary to complete the Work required by this Contract, within time specified, in accordance with provisions of Construction Documents.
- B. All equipment and materials incorporated in the Work covered by this Contract are to be new; use recycled and / or recovered materials to extent that such use is technically and economically feasible. Recovered materials are products recovered from solid waste in form identical to original form for use that is same as, or similar to original use. Recycled materials are products manufactured from solid waste.
- C. If requested, Contractor shall furnish satisfactory evidence as to kind and quality of construction materials proposed or used. Contractor shall furnish to Architect / Engineer, for approval, manufacturer name and model, performance capacities and other pertinent information of machinery, mechanical, electrical or other types of equipment, which Contractor plans to install.
- D. If not otherwise provided, materials and labor called for in this Contract shall be provided and performed in accordance with established practice and standards recognized by Architects, Engineers, Department, and construction industry.
- E. Reference to “Standard” specifications of any association or manufacturer, or codes of County authorities, intends most recent printed edition or catalog in effect on date that corresponds with date of Construction Documents.
- F. Whenever reference is made in Specifications that work shall be “performed”, “applied”, in accordance with “manufacturer’s directions or instructions”, Contractor to whom those instructions are directed shall furnish three (3) printed copies of such instructions to Architect / Engineer before execution of the Work.

9. CONTRACTOR’S TITLE TO MATERIALS

- A. Contractor or any subcontractor shall not purchase materials or supplies for the Work subject to any chattel mortgage or under conditional sale contract or other agreement by which seller retains interest. Contractor warrants that all materials and supplies used in the Work are free from all liens, claims or encumbrances and Contractor has good title to them.

10. “OR EQUAL” CLAUSE

- A. Whenever equipment or materials are identified on Drawings or in Specifications by reference to manufacturer’s or vendor’s name, trade name, catalog number, and other identifying information, it is intended to establish standards; and any equipment or material of other manufacturers and vendors which will perform adequately duties imposed by general design will be considered equally accepted provided equipment or material so proposed is, in opinion of Architect / Engineer, of equal substance and function. Architect / Engineer and Department shall provide written approval before Contractor may purchase or install it.

- B. Equipment or materials of manufacturers, other than those named, may be used only upon following conditions:
1. That, in opinion of Architect / Engineer and Department, proposed material or equipment item is fully equal or superior (in design, materials, construction, workmanship, performance, finish, etc.) to named item. No compromise in quality level, however small, is acceptable.
 2. That, in substituting materials or equipment, Contractor assumes responsibility for any changes in system or for modifications required in adjacent or related work to accommodate such substitution despite Architect / Engineer's and Department's approval, and all costs growing out of approval of "or equal" items shall be responsibility of Contractor. No extra costs resulting from such approval shall become responsibility of Department, Architect / Engineer or any other separate Contractor.
 3. It shall be understood that use of materials or equipment other than those specified, or approved equal by Architect / Engineer and Department, shall constitute violation of Contract, and that Architect / Engineer and Department shall have right to require removal of such materials or equipment and their replacement with specified materials or equipment at Contractor's expense.
 4. Product and manufacturer named first in Specifications or on information shown on Drawings is basis of selection of manufactured items and equipment, particularly mechanical equipment. In using other than first named products or manufacturers, including those specified as additionally approved or acceptable, Contractor assumes responsibility for any changes in system and for modifications in any work required to accommodate them. Architect / Engineer's approval of such additionally acceptable products or manufacturers, either in Specifications or in Addendum, does not relieve Contractor from obligation to coordinate such optional products with other Contractors, whose work may be affected by them, and to pay all additional costs resulting from their inclusion into the Work. Contractor's liability shall include payment of Architect / Engineer's fees for any additional services made necessary by or directly connected to such product changes. No extra costs resulting from such changes shall become responsibility of Department, Architect / Engineer or any other separate Contractor.
- C. No request for approval of "or equal" materials will be entertained except from Contractor. Identify any request for substitution as substitution on Contractor's letter of transmittal and give reasons for substitution. Department may in its sole discretion allow substitutions of materials.

11. PATENTS AND ROYALTIES

- A. If Contractor uses any design, device or material covered by letters, patent or copyright, it is mutually agreed and understood, that, without exception, contract prices shall include all royalties or costs arising from use of such design, device or materials, in any way involved in the Work.
- B. Contractor shall indemnify and save harmless County from any and all claims for infringement by reason of use of such patent or copyright in connection with the Work agreed to be performed under this Contract, and shall indemnify County for any cost, expense or damage which it may be obliged to pay by reason of such infringement at any time during prosecution of the Work or after completion of the Work.

12. SURVEYS, PERMITS, REGULATIONS AND TAXES

- A. Department will furnish to Contractor all site, topography and property surveys necessary for execution of the Work.

- B. Contractor shall procure all permits, licenses and approvals necessary for execution of this Contract.
- C. Contractor shall give all notices and comply with all State of Wisconsin, Federal and local laws, codes, rules and regulations relating to performance of the Work, protection of adjacent property, and maintenance of passageways, guard fences or other protective facilities.
- D. Contractor does not need to pay State and local sales & use taxes. See Wisconsin Statute 77.54 (9m).
- E. Contractor shall promptly notify Architect / Engineer of any variances of Drawings or Specifications with that of any State of Wisconsin, federal or local law, code, rule or regulation. Upon such notification, Architect / Engineer will require correction of variance to comply with applicable law, code, rule or regulation at no additional cost to Contractor.
- F. Work under this Contract shall comply with all applicable State of Wisconsin, Federal and local laws, codes and regulations.
- G. Contractor shall pay charges for water, sewer and other utility connections made by municipalities where required by Specifications.

13. CONTRACTOR'S OBLIGATIONS AND SUPERINTENDENCE

- A. Contractor shall provide and pay for all materials, labor, tools, equipment, transportation and superintendence necessary to execute, complete and deliver the Work within specified time. Contractor agrees to secure at their own expense all personnel necessary to carry out the Work. Such personnel shall not be deemed County employees nor shall they have or be deemed to have any direct contractual relationship with County.
- B. Performance of any work necessary after regular working hours, on Sundays or Legal Holidays shall be without additional expense to County. Performance of any work at site at other than normal working hours must be coordinated with Public Works Project Manager.
- C. Contractor shall furnish, erect, maintain and remove such temporary works as may be required.
- D. Contractor shall observe, comply with, and be subject to all terms, conditions, requirements and limitations of Construction Documents.
- E. At the Work site, Contractor shall give personal superintendence to the Work or shall employ construction superintendent or foreman, experienced in character of work covered by Contract, who shall have full authority to act for Contractor. Understand that such superintendent or foreman shall be acceptable to Architect / Engineer and Department.
- F. Remove from project or take other corrective action upon notice from Architect / Engineer or Department for Contractor's employees whose work is considered by Architect / Engineer or Department to be unsatisfactory, careless, incompetent, unskilled or otherwise objectionable.
- G. Contractor and subcontractors shall be required to conform to Labor Laws of State of Wisconsin and various acts amendatory and supplementary thereto and to other laws, ordinances and legal requirements applicable to the Work.

- H. Presence and observation of the Work by Architect / Engineer or Public Works Project Manager shall not relieve Contractor of any obligations.

14. WEATHER CONDITIONS

- A. In event of temporary suspension of work, or during inclement weather, or whenever Architect / Engineer shall direct, Contractor shall, and shall cause subcontractors to protect carefully all work and materials against damage or injury from weather. If, in opinion of Architect / Engineer or Department, any work or materials that have been damaged or injured due to failure on part of Contractor or any subcontractors so to protect the Work, such materials shall be removed and replaced at expense of Contractor.

15. PROTECTION OF WORK AND PROPERTY

- A. Contractor shall at all times safely guard County's property from injury or loss in connection with this Contract. Contractor shall at all times safely guard and protect the Work, and adjacent property, from damage. Contractor shall replace or make good any such damage, loss or injury unless such is caused directly by errors contained in Contract, or by County, or County's duly authorized representative.
- B. Contractor may act diligently, without previous instructions from Architect / Engineer and / or Department, in emergency that threatens loss or injury of property, or safety of life. Contractor shall notify Architect / Engineer and / or Department immediately thereafter. Promptly submit any claim for compensation by Contractor due to such extra work to Architect / Engineer and / or Department for approval as provided for in Article 18 herein.

16. INSPECTION AND TESTING OF MATERIALS

- A. Authorized representatives and agents of County government shall have access at all times to the Work wherever it is in preparation or progress and Contractor shall provide facilities for such access and for inspection.
- B. Should it be considered necessary or advisable at any time before final acceptance of the Work to make examination of work already completed, by removing or tearing out same, Contractor shall upon request, promptly furnish all necessary facilities, labor and materials. If such work is found to be defective in any aspect, due to fault of Contractor or subcontractors thereof, Contractor shall assume all expenses of such examination and of satisfactory reconstruction. Contractor will be reimbursed for such examination and replacement in accordance with Article 18 - A.3., of these General Conditions of Contract if such work is found to meet requirements of Contract.
- C. If Specifications, Architect / Engineer's, or Public Works Project Manager's instructions require any work to be specially tested or approved, Contractor shall give Architect / Engineer and Public Works Project Manager timely notice of its readiness for testing or inspection. Test all materials and equipment requiring testing in accordance with accepted or specified standards, as applicable. Architect / Engineer shall recommend laboratory or inspection agency and Department will select and pay for all initial laboratory inspection services. Should retesting be required, due to failure of initial testing, cost of such retesting shall be borne by Contractor.
- D. Cost of any testing performed by manufacturers or Contractor for substantiating acceptability of proposed substitution of materials and equipment, or necessary conformance testing in

conjunction with manufacturing processes or factory assemblage, shall be borne by Contractor or manufacturer responsible.

17. REPORTS, RECORDS AND DATA

- A. Contractor shall submit to Architect / Engineer and Public Works Project Manager such schedule of quantities and costs, progress schedules, payrolls, reports, estimates, invoices, records and other data as either may request concerning work performed or to be performed under this Contract.

18. CHANGES IN THE WORK

- A. Make no changes, except in cases of emergency, in the Work covered by approved Construction Documents without having prior written approval of Department. Charges or credits for the Work covered by approved change shall be determined by one of these methods:
1. Unit bid prices previously approved.
 2. Agreed lump sum based on actual cost of:
 - a) Labor, including foremen, and all fringe benefits that are associated with their wages.
 - b) Materials entering permanently into the Work.
 - c) Ownership or rental cost of construction tools and equipment during time of use on extra work.
 - d) Power and consumable supplies for operation of power equipment.
 - e) Workmen's Compensation Insurance, Contractor's Public Liability and Property Damage Insurance, and Comprehensive Automobile Liability Insurance.
 - f) Social Security and old age and unemployment contributions.
 - g) Add to cost under (2), fixed fee to be agreed upon, but not to exceed fifteen percent (15%) of actual cost of work performed with their own labor force. Fee shall be compensation to cover cost of supervision, overhead, bond, profit and any other general expense.
 - h) On that portion of the Work under (2) done under subcontract, Contractor may include not over seven and one-half percent (7½%) for supervision, overhead, bond, profit and any other general expense.
 - i) Department may require correct amount of costs with supporting vouchers; Contractor shall keep and present in such form as directed.
 3. Cost-plus work, with not-to-exceed dollar limit, based on actual cost of:
 - a) Labor, including foremen, and all fringe benefits that are associated with their wages.
 - b) Materials entering permanently into the Work.
 - c) Ownership or rental cost of construction tools and equipment during time of use on extra work. Rental cost cannot exceed fifty percent (50%) replacement value of rented equipment.
 - d) Power and consumable supplies for operation of power equipment.
 - e) Workmen's Compensation Insurance, Contractor's Public Liability and Property Damage Insurance, and Comprehensive Automobile Liability Insurance.
 - f) Social Security and old age and unemployment contributions.
 - g) To cost under (3), there shall be added fixed fee to be agreed upon but not to exceed fifteen percent (15%) of actual cost of work performed with their own labor force. Fee shall be compensation to cover cost of supervision, overhead, bond, profit, and any other general expense.
 - h) On that portion of the Work under (3) done under subcontract, Contractor may include not over seven and one-half percent (7½%) for supervision, overhead, bond, profit, and any other general expense.

- i) Contractor shall keep and present, in such form as directed, correct amount of cost together with such supporting vouchers as may be required by Department.
- B. If Contractor claims that by any instructions given by Architect / Engineer, Department, by drawings or otherwise, regarding performance of the Work or furnishing of material under Contract, involves extra cost, Contractor shall give Department written notice of cost thereof within two (2) weeks after receipt of such instructions and in any event before proceeding to execute work, unless delay in executing work would endanger life or property.
- C. No claim for extra work or cost shall be allowed unless it was done in pursuance of written Change Order from Architect / Engineer and approved by Department, as previously mentioned, and claim presented with payment request submitted after changed or extra work is completed.
- D. Negotiation of cost for change in the Work shall not be cause for Contractor to delay prosecution of the Work if Contractor has been authorized in writing by Public Works Project Manager to proceed.

19. EXTRAS

- A. Without invalidating Contract, Department may order extra work or make changes by altering, adding to or deducting from the Work, contract sum being adjusted in accordance with Article 18 herein.

20. TIME FOR COMPLETION

- A. Contractor agrees that the Work shall be prosecuted regularly and diligently and complete the Work as stated in Construction Documents.

21. CORRECTION OF WORK

- A. All work, all materials whether incorporated in the Work or not, and all processes of manufacture shall at all times and places be subject to inspection of Architect / Engineer and Public Works Project Manager who shall be judge of quality and suitability of the Work, materials, and processes of manufacture for purposes for which they are used. Should they fail to meet Architect / Engineer's and Public Works Project Manager's approval they shall be reconstructed, made good, replaced or corrected, by Contractor at Contractor's expense. Immediately remove all rejected material from site.
- B. If Contractor defaults or neglects to carry out the Work in accordance with Construction Documents or fails to perform any provision of Contract, Department may, after ten (10) business days' written notice to Contractor and without prejudice to any other remedy County may have, make good such deficiencies. In such case, appropriate Change Order shall be issued deducting from Contractor's payments then or thereafter, cost of correcting such deficiencies, including cost of Architect / Engineer's additional services made necessary by such default, neglect or failure.

22. SUBSURFACE CONDITIONS FOUND DIFFERENT

- A. If Contractor encounters subsurface or latent conditions at site materially differing from those shown on Drawings or indicated in Specifications, Contractor shall immediately give notice to Architect / Engineer and Public Works Project Manager of such conditions before they are

disturbed. Architect / Engineer will thereupon promptly investigate conditions, and if Architect / Engineer finds that they materially differ from those shown on Drawings or indicated in Specifications, Architect / Engineer will at once make such changes as necessary, any increase or decrease of cost resulting from such changes to be adjusted in manner provided in above Article 18 entitled "Changes in the Work".

23. RIGHT OF DEPARTMENT TO TERMINATE CONTRACT

- A. In event that any provisions of this Contract are violated by Contractor or by any subcontractors, County may serve written notice upon Contractor and Surety of its intention to terminate Contract, such notice to contain reasons for such intention to terminate Contract, and unless within ten (10) business days after serving of such notice upon Contractor, such violation or delay shall cease and satisfactory arrangement or correction be made, Contract shall, upon expiration of said ten (10) business days, cease and terminate.
- B. In event of any such termination, County shall immediately serve notice thereof upon Surety and Contractor, and Surety shall have right to take over and perform Contract subject to County's approval; provided, however, that if Surety does not commence performance thereof within ten (10) business days from date of mailing to such Surety of notice of termination, County may take over the Work and prosecute same to completion by contract, or by force account, at expense of Contractor; Contractor and Surety shall be liable to County for any excess cost occasioned County thereby, and in such event County may take possession of and utilize in completing the Work, such materials and equipment as may be on the Work site and therefore necessary.

24. CONSTRUCTION SCHEDULE AND PERIODIC ESTIMATES

- A. Contractor shall be responsible for Construction Schedule and coordination. Immediately after execution and delivery of Contract and before making first payment, Contractor shall notify all subcontractors to furnish all required information to develop Construction Schedule. Contractor and all subcontractors associated with the Work shall furnish following information from each Division of Specifications:
 - 1. List of construction activities;
 - 2. Start, finish and time required for completion of each activity;
 - 3. Sequential relationships between activities;
 - 4. Identify all long lead-time items, key events, meetings or activities such as required submittals, fabrication and delivery, procurement of materials, installation and testing;
 - 5. Weekly definition of extent of work and areas of activity for each trade or Subcontract; and
 - 6. Other information as determined by Public Works Project Manager.
- B. In addition to above requested items, Contractor shall request delivery dates for all County-furnished equipment, materials or labor. This shall include any work handled by Department under separate contracts such as asbestos abatement, air and water balancing, etc. Indicate on Construction Schedule these associated delivery and installation dates.
- C. Progress Reporting:
 - 1. Contractor shall update and publish Construction Schedule on monthly basis. Revisions to Schedule shall be by Contractor and made in same detail as original Schedule and accompanied by explanation of reasons for revision; and shall be subject to approval by Department.

2. Failure of Contractor to keep Schedule in updated format shall result in County hiring firm specializing in construction schedule development and deducting those costs associated with updating process from payments due Contractor.
 3. Contractor shall submit show actual percentage of each activity completed, estimated future progress, and anticipated completion time.
- D. Responsibility for timely completion requires:
1. Contractor and subcontractors understand that performance of each is interdependent upon performance of others.
 2. Whenever it becomes apparent from current schedule, that phasing or progress completion dates will not be met, Contractor must take some or all following actions at no additional cost to County:
 - a) Increase construction labor in such quantities and crafts as will eliminate backlog of work.
 - b) Increase number of working hours per shift, shifts per working day, working days per week, amount of construction equipment, or any combination of foregoing to eliminate backlog of work.
 - c) Reschedule work (yet remain in conformance with Drawings and Specifications).
 3. Prior to proceeding with any of above actions, Contractor shall notify Public Works Project Manager.
- E. Maintain current Construction Schedule at all times. Revise Construction Schedule in same detail as original and accompany with explanation of reasons for revision. Schedule shall be subject to approval by Architect / Engineer and Public Works Project Manager.

25. PAYMENTS TO CONTRACTOR

- A. Contractor shall provide:
1. Detailed estimate giving complete breakdown of contract price by Specification Division; and
 2. Periodic itemized estimates of work done for purpose of making partial payments thereon.
- B. Submit these estimates for approval first to Architect / Engineer, then to Public Works Project Manager. Costs employed in making up any of these schedules are for determining basis of partial payments and not considered as fixing basis for additions to or deductions from Contract price.
- C. County will make partial payments to Contractor for value, proportionate to amount of Contract, of all labor and material incorporated in the Work during preceding calendar month upon receipt of Application and Certificate for Payment form from Architect / Engineer and approval of Department.
- D. Contractor shall submit for approval first to Architect / Engineer, and then to Public Works Project Manager all Application and Certificate for Payment forms. If requested, Application and Certificate for Payment shall be supported by such additional evidence as may be required, showing Contractor's right to payment claimed.
- E. Application and Certificate for Payment for preparatory work and materials delivered and suitably stored at site to be incorporated into the Work at some future period, will be given due consideration. Requesting payment for materials stored off site, may be rejected, however, if deemed essential for reasons of job progress, protection, or other sufficient cause, requests will be considered, conditional upon submission by Contractor of bills of sale,

photographs and such other procedures as will adequately protect County's interest such as storage in bonded warehouse with adequate coverage. If there is any error in payment, Contractor is obligated to notify Department immediately, but no longer than ten (10) business days from receipt of payment.

- F. Payments by County will be due within forty-five (45) business days after receipt by Department of Application and Certificate for Payment.
- G. County will retain five percent (5%) of each Application and Certificate for Payment until final completion and acceptance of all the Work covered by Contract. However, anytime after fifty percent (50%) of the Work has been furnished and installed at site, County will make remaining payments in full if Architect / Engineer and Public Works Project Manager find that progress of the Work corresponds with Construction Schedule. If Architect / Engineer and Public Works Project Manager find that progress of the Work does not correspond with Construction Schedule, County may retain up to ten percent (10%) of each Application and Certificate for Payment for the Work completed.
- H. All material and work covered by partial payments made shall become sole property of County, but this provision shall not be construed as relieving Contractor from sole responsibility for care and protection of materials and work upon which payments have been made, or restoration of any damaged work, or as waiver of right of County to require fulfillment of all of terms of Contract.
- I. County will make final payment within sixty (60) calendar days after final completion of the Work, and will constitute acceptance thereof.
- J. County may make payment in full, including retained percentages and less authorized deductions, upon completion and acceptance of each Division where price is stated separately in Contract.
- K. Every contractor engaged in performance of any contract for Department of Public Works, Highway & Transportation shall submit to this Department, as requested and with final application for payment for work under said contract, affidavit(s) as required to prove that all debts and claims against this Work are paid in full or otherwise satisfied, and give final evidence of release of all liens against the Work and County.

26. WITHHOLDING OF PAYMENTS

- A. County, after having served written notice on said Contractor, may either pay directly any unpaid bills of which Department has written notice, or withhold from Contractor's unpaid compensation sum of money deemed reasonably sufficient to pay any and all such lawful claims until satisfactory evidence is furnished that all liabilities have been fully discharged; whereupon, payment to Contractor shall be resumed in accordance with terms of this Contract, but in no event shall these provisions be construed to impose any obligations upon County to either Contractor or Contractor's Surety.
- B. In paying any unpaid bills of Contractor, County shall be deemed agent of Contractor, and any payment so made by County, shall be considered as payment made under Contract by County to Contractor and County shall not be liable to Contractor for any such payment made in good faith.
- C. Contractor shall indemnify, hold harmless and defend Dane County, its boards, commissions, agencies, officers, employees and representatives from all claims growing out of lawful

demands of subcontractors, laborers, workers, mechanics, material men, and furnishers of machinery and parts thereof, equipment, power tools, and all supplies, including commissary, incurred in performance of this Contract.

- D. At Department's request, Contractor shall furnish satisfactory evidence that all obligations of nature designated above have been paid, discharged or waived.

27. ACCEPTANCE OF FINAL PAYMENT AS RELEASE

- A. Making of final payment shall constitute waiver of all claims by County except those arising from:
 - 1. Unsettled lien;
 - 2. Faulty or defective work appearing after substantial completion;
 - 3. Failure of the Work to comply with requirements of Construction Documents; or
 - 4. Terms of any special guarantees required by Construction Documents.
- B. Acceptance of final payment shall constitute waiver of all claims by Contractor.

28. PAYMENTS BY CONTRACTOR

- A. Contractor shall pay following not later than fifth (5th) business day following each payment received from County:
 - 1. All transportation and utility services rendered;
 - 2. All materials, tools, and other expendable equipment that have been delivered at site of the Work to extent of ninety percent (90%) of cost thereof, and balance of cost thereof when said balance is paid to Contractor; and
 - 3. Each subcontractor, respective amount allowed Contractor because of work performed by subcontractor to extent of subcontractor's interest therein.

29. CONTRACT SECURITY

- A. Contractor shall furnish Performance and Payment Bonds in amount at least equal to one hundred percent (100%) of Contract price as security for faithful performance of this Contract and payment of all persons performing labor on project under this Contract and furnishing materials in connection with this Contract.
- B. Sample Performance and Payment Bonds that Contractor will be required to execute is bound into these Construction Documents. Before construction Contract is consummated, completed Performance and Payment Bonds must be approved by Department.

30. ASSIGNMENTS

- A. Contractor shall not assign whole or any part of this Contract or any moneys due or to become due hereunder without written consent of Department. In case Contractor assigns all or any part of any moneys due or to become due under this Contract, instrument of assignment shall contain clause substantially to effect that it is agreed that right of assignee in and to any moneys due or to become due to Contractor shall be subject to prior claims of all persons, firms and corporations for services rendered or materials supplied for performance of the Work called for in this Contract.

31. MUTUAL RESPONSIBILITY OF CONTRACTORS

- A. If, through acts of neglect on part of Contractor or any subcontractor shall suffer loss or damage on the Work, Contractor agrees to settle with such subcontractor by agreement or arbitration if such other subcontractor will so settle. If such subcontractor shall assert any claim against County on account of any damage alleged to have been sustained, Department shall notify Contractor, who shall indemnify, hold harmless and defend Dane County, its boards, commissions, agencies, officers, employees and representatives against any such claim.

32. SEPARATE CONTRACTS

- A. Department may award other contracts for the Work and all Contractors shall fully cooperate with each other and carefully adjust their work to that provided under other contracts as may be directed by Department. No Contractor shall commit or permit any act that will interfere with performance of the Work by any other Contractor.
- B. Contractor shall coordinate the Work with those of other Contractors. Cooperation will be required in arrangement for storage of materials and in detailed execution of the Work. Contractor, including subcontractors, shall keep informed of progress and detail work of others and shall notify Architect / Engineer or Department immediately of lack of progress or defective workmanship on part of others. Failure of Contractor to keep informed of the Work progressing on site and failure to give notice of lack of progress or defective workmanship by others shall be construed as acceptance by Contractor of status of the Work as being satisfactory for proper coordination with Contractor's own work.

33. SUBCONTRACTS

- A. Contractor may use services of specialty subcontractors on those parts of the Work that, under normal contracting practices, are performed by specialty subcontractors.
- B. Contractor shall not award any work to any subcontractor without prior approval of Department. Qualifications of subcontractors shall be same as qualifications of Contractor. Request for subcontractor approval shall be submitted to Department fifteen (15) business days before start of subcontractor's work. If subcontractors are changed or added, Contractor shall notify Department in writing.
- C. Contractor shall be as fully responsible to County for acts and omissions of subcontractors, and of persons either directly or indirectly employed by them, as Contractor is for acts and omissions of persons directly employed by Contractor.
- D. Contractor shall cause appropriate provisions to be inserted in all subcontracts relative to the Work to bind subcontractors to Contractor by terms of General Conditions of Contract and other Construction Documents insofar as applicable to work of subcontractors and to give Contractor same power as regards terminating any subcontract that Department may exercise over Contractor under any provision of Construction Documents.
- E. Nothing contained in this Contract shall create any contractual relation between any subcontractor and County.
- F. Contractor shall insert in all subcontracts, Articles 26, 33, 43 and 45, respectively entitled: "Withholding of Payments", "Subcontracts", "Affirmative Action Provision and Minority / Women / Disadvantaged Business Enterprises", and "Minimum Wages", and shall further require all subcontractors to incorporate physically these same Articles in all subcontracts.

34. PROJECT MANAGER'S AUTHORITY

- A. Public Works Project Manager shall:
 - 1. Administer and ensure compliance with Construction Documents;
 - 2. Provide responsible on-site observations of construction and have authority to request work and to stop work whenever necessary to insure proper enforcement of Construction Documents;
 - 3. Convene and chair project meetings and foreman's coordination meetings when necessary to coordinate resolution of conflicts between Contractors, Architects, Engineers, Consultants, and Department; and
 - 4. Check and inspect material, equipment and installation procedures of all trades for proper workmanship and for compliance with Drawings, Specifications and Shop Drawings, permit no material on project site that is not satisfactory and reject work not in compliance with Construction Documents.

35. CONSULTANT'S AUTHORITY

- A. Engineer is retained by, and is responsible to Department acting for County.
- B. Engineer shall determine amount, quality, acceptability, and fitness of several kinds of work and materials that are provided under this Contract and shall decide all questions that may arise in relation to said work and construction thereof.
- C. Engineer shall decide meaning and intent of any portion of Specifications and of any Drawings where they may be found obscure or be in dispute.
- D. Engineer shall provide responsible observation of construction. Architect / Engineer has authority to stop the Work whenever such stoppage may be necessary to insure proper execution of Construction Documents.
- E. Engineer shall be interpreter of conditions of Construction Documents and judge of its performance.
- F. Within reasonable time, Engineer shall make decisions on all matters relating to progress of the Work or interpretation of Construction Documents.
- G. Engineer's decisions are subject to review by Public Works Project Manager.

36. STATED ALLOWANCES

- A. Stated allowances enumerated in Instructions to Bidders shall cover net cost of materials or equipment, and all applicable taxes. Contractor's cost of delivery and unloading at site, handling costs on site, labor, installation costs, overhead, profit and any other incidental costs shall be included in Contractor's bid, but not as part of cash allowance.
- B. Department will solicit at least two (2) bids on materials or equipment for which allowance is stated and select on basis of lowest qualified responsible bid. Contractor will then be instructed to purchase "Allowed Materials". If actual price for purchasing "Allowed Materials", including taxes, is more or less than "Cash Allowance", Contract price shall be adjusted accordingly. Adjustment in Contract price shall not contain any cost items excluded from cash allowance.

37. ESTIMATES OF QUANTITIES

- A. Whenever estimated quantities of work to be done and materials to be furnished under this Contract are shown in any of Construction Documents, they are given for use in comparing bids and right is especially reserved to increase or diminish them as they may be deemed reasonably necessary or desirable by Department to complete the Work included in this Contract, and cost for such increase or diminution shall be adjusted in manner provided for in General Conditions of Contract Article 18 entitled “Changes in the Work”.

38. LANDS AND RIGHTS-OF-WAY

- A. Prior to start of construction, County shall furnish all land and rights-of-way necessary for carrying out and completion of the Work to be performed under this Contract.

39. GENERAL GUARANTEE

- A. Neither final certificate of payment nor any provision in Construction Documents nor partial or entire occupancy of premises by County shall constitute acceptance of work not done in accordance with Construction Documents or relieve Contractor of liability in respect to any expressed warranties or responsibility for faulty materials or workmanship.
 - 1. In no event shall making of any payment required by Contract constitute or be construed as waiver by County of any breach of covenants of Contract or waiver of any default of Contractor and making of any such payment by County while any such default or breach shall exist shall in no way impair or prejudice right of County with respect to recovery of damages or other remedy as result of such breach or default.
- B. Contractor shall remedy and make good all defective workmanship and materials and pay for any damage to other work resulting there from, which appear within period of one (1) year from date of substantial completion, providing such defects are not clearly due to abuse or misuse by County. Department will give notice of observed defects with reasonable promptness.
- C. Guarantee on work executed after certified date of substantial completion will begin on date when such work is inspected and approved by Engineer’s, and Public Works Project Manager.
- D. Where guarantees or warranties are required in sections of Specifications for periods in excess of one (1) year, such longer terms shall apply; however, Contractor’s Performance and Payment Bonds shall not apply to any guarantee or warranty period in excess of one (1) year.

40. CONFLICTING CONDITIONS

- A. Any provision in any of Construction Documents which may be in conflict or inconsistent with any Articles in these General Conditions of Contract or Supplementary Conditions shall be void to extent of such conflict or inconsistency.
- B. In case of ambiguity or conflict between Drawings and Specifications, Specifications shall govern.

- C. Printed dimensions shall be followed in preference to measurements by scale. Large-scale drawings take precedence over small-scale drawings. Dimensions on Drawings and details are subject to field measurements of adjacent work.

41. NOTICE AND SERVICE THEREOF

- A. Any notice to Contractor from Department relative to any part of this Contract shall be in writing and considered delivered and service thereof completed, when said notice is posted, by certified or registered mail, to Contractor at Contractor's last given address, or delivered in person to said Contractor, or Contractor's authorized representative on the Work.

42. PROTECTION OF LIVES AND HEALTH

- A. In order to protect lives and health of Contractor's employees under Contract, Contractor shall comply with all pertinent provisions of Wisconsin Administrative Code, Rules of Department of Commerce, relating to Safety and Health.
- B. Contractor alone shall be responsible for safety, efficiency and adequacy of Contractor's tools, equipment and methods, and for any damage that may result from their failure or their improper construction, maintenance or operation.

43. AFFIRMATIVE ACTION PROVISION AND MINORITY / WOMEN / DISADVANTAGED BUSINESS ENTERPRISES

- A. Affirmative Action Provisions.
 - 1. During term of their Contract, Contractor agrees not to discriminate on basis of race, religion, color, sex, handicap, age, sexual preference, marital status, physical appearance, or national origin against any person, whether recipient of services (actual or potential), employee, or applicant for employment. Such equal opportunity shall include but not be limited to following: employment, upgrading, demotion, transfer, recruitment, advertising, layoff, termination, training, rates of pay, and any other form of compensation or level of service(s). Contractor agrees to post in conspicuous places, these affirmative action standards so as to be visible to all employees, service recipients and applicants for this paragraph. Listing of prohibited bases for discrimination shall not be construed to amend in any fashion state or federal law setting forth additional bases and exceptions shall be permitted only to extent allowable in state or federal law.
 - 2. Contractor is subject to this Article only if Contractor has twenty (20) or more employees and receives \$20,000.00 or more in annual aggregate contracts with County. Contractor shall file and Affirmative Action Plan with Dane County Contract Compliance Specialist in accord with Chapter 19 of Dane County Code of Ordinances. Such plan must be filed within fifteen (15) business days of effective date of this Contract and failure to do so by said date shall constitute ground for immediate termination of Contract by County. Contractor shall also, during term of this Contract, provide copies of all announcements of employment opportunities to County's Office of Equity & Inclusion, and shall report annually number of persons, by race, sex and handicap status, who apply for employment, and, similarly classified, number hired and number rejected.
 - 3. Contact Dane County Contract Compliance Specialist at Dane County Office of Equity & Inclusion, 210 Martin Luther King, Jr. Blvd., Room 356, Madison, WI 53703, 608/266-4192.
 - 4. In all solicitations for employment placed on Contractor's behalf during term of this Contract, Contractor shall include statement to affect Contractor is "Equal Opportunity Employer". Contractor agrees to furnish all information and reports required by

County's Contract Compliance Specialist as same relate to affirmative action and nondiscrimination, which may include any books, records, or accounts deemed appropriate to determine compliance with Chapter 19, Dane County Code of Ordinances, and provision of this Contract.

- B. Minority / Women / Disadvantaged / Emerging Small Business Enterprises.
 - 1. Chapter 19.508 of Dane County Code of Ordinances is official policy of Dane County regarding utilization of, to fullest extent of, Minority Business Enterprises (MBEs), Women Business Enterprises (WBEs) Disadvantage Business Enterprises (DBEs) and Emerging Small Business Enterprises (ESBEs).
 - 2. Contractor may utilize MBEs / WBEs / DBEs / ESBEs as subcontractors or suppliers. List of subcontractors will be required of low bidder as stated in this Contract. List shall indicate which are MBEs / WBEs / DBEs / ESBEs and percentage of subcontract awarded, shown as percentage of total dollar amount of bid.

44. COMPLIANCE WITH FAIR LABOR STANDARDS

- A. During term of this Contract, Contractor shall report to County Contract Compliance Specialist, within ten (10) business days, any allegations to, or findings by National Labor Relations Board (NLRB) or Wisconsin Employment Relations Commission (WERC) that Contractor has violated statute or regulation regarding labor standards or relations. If investigation by Contract Compliance Specialist results in final determination that matter adversely affects Contractor's responsibilities under this Contract, and which recommends termination, suspension or cancellation of this Contract, County may take such action.
- B. Contractor may appeal any adverse finding by Contract Compliance Specialist as set forth in Dane County Ordinance 25.015(11)(c) through (e).
- C. Contractor shall post this statement in prominent place visible to employees: "As condition of receiving and maintaining contract with Dane County, this employer shall comply with federal, state and all other applicable laws prohibiting retaliation or union organizing."

45. DOMESTIC PARTNERSHIP BENEFITS

- A. Not Used.

46. USE AND OCCUPANCY PRIOR TO ACCEPTANCE

- A. Contractor agrees to use and occupancy of portion or unit of the Work before formal acceptance by Department, provided Department:
 - 1. Secures written consent of Contractor; except when in opinion of Public Works Project Manager, Contractor is chargeable with unwarranted delay in final cleanup of punch list items or other Contract requirements.
 - 2. Secures endorsement from insurance carrier and consent of Surety permitting occupancy of building or use of the Work during remaining period of construction, or, secures consent of Surety.
 - 3. Assumes all costs and maintenance of heat, electricity and water.
 - 4. Accepts all work completed within that portion or unit of the Work to be occupied, at time of occupancy.

47. MINIMUM WAGES

- A. Contractor shall post, at appropriate conspicuous point on site of project, schedule showing all determined minimum wage rates for various classes of laborers and mechanics to be engaged in the Work under this Contract and all deductions, if any, required by law to be made from unpaid wages actually earned by laborers and mechanics so engaged.
- B. Supplementary Conditions section in Construction Documents lists wage determinations required by State Law.
- C. If, after award of Contract, it becomes necessary to employ any person in trade or occupation not classified in wage determinations, such person shall be paid at not less than such rate as shall be determined by Wisconsin Department of Workforce Development. Such approved minimum rate shall be retroactive to time of initial employment of such person in such trade or occupation. Contractor shall notify Department of Contractor's intention to employ persons in trades or occupations not so classified in sufficient time for Department to obtain approved rates for such trades or occupations.
- D. Specified wage rates are minimum rates only, and Department will not consider any claims for additional compensation made by Contractor because of payment by Contractor of any wage rate in excess of applicable rate contained in this Contract. Contractor shall adjust any disputes in regard to payment of wages in excess of those specified in this Contract.

48. CLAIMS

- A. No claim may be made until Department's Deputy Public Works Director has reviewed Engineer's decision as provided for in Article 35 of General Conditions of Contract. If any claim remains unresolved after such review by Department's Deputy Public Works Director, the claim may be filed under Wisconsin Statute 893.80. Work shall progress during period of any dispute or claim. Unless specifically agreed between parties, venue will be in Dane County, Wisconsin.

49. ANTITRUST AGREEMENT

- A. Contractor and County recognize that in actual economic practice, overcharges resulting from antitrust violations are in fact usually borne by County. Therefore, Contractor hereby assigns to County any and all claims for such overcharges as to goods and materials purchased in connection with this Contract, except as to overcharges which result from antitrust violations commencing after price is established under this Contract and any change order thereto.

50. INSURANCE

- A. Contractor Carried Insurance:
 - 1. Contractor shall not commence work under this Contract until Contractor has obtained all insurance required under this Article and has provided evidence of such insurance to Risk Manager, 425 City-County Building, 210 Martin Luther King Jr. Blvd., Madison, WI 53703. Contractor shall not allow any subcontractor to commence work until insurance required of subcontractor has been so obtained and approved. Company providing insurance must be licensed to do business in Wisconsin.
 - 2. Worker's Compensation Insurance:
 - a) Contractor shall procure and shall maintain during life of this Contract, Worker's Compensation Insurance as required by statute for all of Contractor's employees engaged in work at site of project under this Contract and, in case of any such work sublet, Contractor shall require subcontractor similarly to provide Worker's

- Compensation Insurance for all of latter's employees to be engaged in such work unless such employees are covered by protection afforded by Contractor's Worker's Compensation Insurance.
- b) If any claim of employees engaged in hazardous work on project under this Contract is not protected under Worker's Compensation Statute, Contractor shall provide and shall cause each subcontractor to provide adequate Employer's Liability Insurance for protection of such of Contractor's employees as are not otherwise protected.
3. Contractor's Public Liability and Property Damage Insurance:
 - a) Contractor shall procure and maintain during life of this Contract, Contractor's Public Liability Insurance and Contractor's Property Damage Insurance in amount not less than \$1,000,000 bodily injury, including accidental death, to any one person, and subject to same limit for each person, in amount not less than \$1,000,000 on account of one accident, and Contractor's Property Damage Insurance in amount not less than \$1,000,000 or combined single limit of at least \$1,000,000 with excess coverage over and above general liability in amount not less than \$5,000,000. Contractor shall add "Dane County" as additional insured for each project.
 - b) Contractor's Public Liability and Property Damage Insurance shall include Products, Completed Operation, and Contractual Liability under Insurance Contract. "Contractor shall in all instances save, defend, indemnify and hold harmless County and Architect / Engineer against all claims, demands, liabilities, damages or any other costs which may accrue in prosecution of the Work and that Contractor will save, defend, indemnify and hold harmless County and Architect / Engineer from all damages caused by or as result of Contractor's operations" and each shall be listed as additional insured on Contractor's and subcontractors' insurance policies.
 - c) Obligations of Contractor under Article 50.A.2.b) shall not extend to liability of Architect / Engineer, agents or employees thereof, arising out of:
 - 1) Preparation or approval of maps, drawings, opinions, reports, surveys, change orders, designs or specifications; or
 - 2) Giving of or failure to give directions or instructions by Architect / Engineer, agents or employees thereof provided such giving or failure to give is primary cause of injury or damage.
 - d) Contractor shall procure and shall maintain during life of this Contract, Comprehensive Automobile Liability Insurance covering owned, non-owned and hired automobiles for limits of not less than \$1,000,000 each accident single limit, bodily injury and property damage combined with excess coverage over and above general liability in amount not less than \$5,000,000.
 - e) Contractor shall either:
 - 1) Require each subcontractor to procure and to maintain during life of subcontract, subcontractor's Public Liability Property Damage Insurance, and Comprehensive Automobile Liability Insurance of type and in same amount specified in preceding paragraphs; or
 - 2) Insure activities of subcontractors in Contractor's own policy.
 4. Scope of Insurance and Special Hazards: Insurance required under Article 50.A.2 & 50.A.3. hereof shall provide adequate protection for Contractor and subcontractors, respectively, against damage claims which may arise from operations under this Contract, whether such operation be by insured or by anyone directly or indirectly employed by insured and also against any of special hazards which may be encountered in performance of this Contract as enumerated in Supplementary Conditions.
 5. Proof of Carriage of Insurance: Contractor shall furnish Risk Manager with certificates showing type, amount, class of operations covered, effective dates, dates of expiration of policies and "Dane County" listed as additional insured. Such certificates shall also contain (substantially) following statement: "Insurance covered by this certificate will not be canceled or materially altered, except after ten (10) business days written notice has been received by Risk Manager."

B. Builder's Risk:

1. County shall provide Builder's Risk insurance coverage for its insurable interests in construction or renovation projects with completed value of \$1,000,000 or less. Therefore, if project completed value is more than \$1,000,000, Contractor shall obtain and maintain in force, at its own expense, Builder's Risk Insurance on all risks for amount equal to full completed value of covered structure or replacement value of alterations or additions. Any deductible shall not exceed \$25,000 for each loss. Policy shall include occupancy clause and list Dane County as loss payee.

C. Indemnification / Hold Harmless:

1. Contractor shall indemnify, hold harmless and defend Dane County, its boards, commissions, agencies, officers, employees and representatives from and against all claims, damages, losses and expenses including attorneys' fees arising out of or resulting from performance of the Work, provided that any such claim, damage, loss or expense is attributable to bodily injury, sickness, disease or death, or to injury to or destruction of tangible property (other than the Work itself) including loss of use resulting therefrom, and is caused in whole or in part by any act or omission of Contractor, any subcontractor, anyone directly or indirectly employed by any of them or anyone for whose acts any of them may be liable, regardless of whether or not it is caused in part by part indemnified hereunder.
2. In any and all claims against Dane County, its boards, commissions, agencies, officers, employees and representatives or by any employee of Contractor, any subcontractor, anyone directly or indirectly employed by any of them or anyone for whose acts any of them may be liable, indemnification obligation under this Contract shall not be limited in any way by any limitation on amount or type of damages, compensation or benefits payable by or for Contractor or any subcontractor under worker's compensation acts, disability benefits or other employee benefit acts.
3. Obligations of Contractor under this Contract shall not extend to liability of Architect / Engineer, its agents or employees arising out of:
 - a) Preparation or approval of maps, drawings, opinion, reports, surveys, change orders, designs or specifications; or
 - b) Giving of or failure to give directions or instruction by Architect / Engineer, its agents or employees provided such giving or failure to give is primary cause of injury or damage.
4. Dane County shall not be liable to Contractor for damages or delays resulting from work by third parties or by injunctions or other restraining orders obtained by third parties.

51. WISCONSIN LAW CONTROLLING

- A. It is expressly understood and agreed to by parties hereto that in event of any disagreement or controversy between parties, Wisconsin law shall be controlling.

END OF SECTION

SECTION 00 73 00

SUPPLEMENTARY CONDITIONS

1. APPLICATION & CERTIFICATE FOR PAYMENT

- A. Every contractor engaged in performance of any contract for Department of Public Works, Highway & Transportation shall submit partial and final Application & Certificate for Payment for work under said contract. Form shall provide similar information as shown on AIA G702™ and G703™ forms (samples shown below). Forms shall be submitted to Public Works Project Manager for approval.



AIA Document G702™ – 1992

Application and Certificate for Payment

TO OWNER:	PROJECT:	APPLICATION NO:	Distribution to:
		PERIOD TO:	OWNER <input type="checkbox"/>
FROM CONTRACTOR:	VIA ARCHITECT:	CONTRACT FOR:	ARCHITECT <input type="checkbox"/>
		CONTRACT DATE:	CONTRACTOR <input type="checkbox"/>
		PROJECT NOS:	FIELD <input type="checkbox"/>
			OTHER <input type="checkbox"/>

CONTRACTOR'S APPLICATION FOR PAYMENT
Application is made for payment, as shown below, in connection with the Contract AIA Document G703™, Continuation Sheet, is attached.

1. ORIGINAL CONTRACT SUM	\$
2. NET CHANGE BY CHANGE ORDERS	\$
3. CONTRACT SUM TO DATE (Line 1 + 2)	\$
4. TOTAL COMPLETED & STORED TO DATE (Column G on G703)	\$

5. RETAINAGE:

a. _____ % of Completed Work
(Columns D + E on G703)

b. _____ % of Stored Material
(Column F on G703)

Total Retainage (Lines 5a + 5b, or Total in Column I of G703)

6. TOTAL EARNED LESS RETAINAGE

(Line 4 minus Line 5 Total)

7. LESS PREVIOUS CERTIFICATES FOR PAYMENT

(Line 6 from prior Certificate)

8. CURRENT PAYMENT DUE

9. BALANCE TO FINISH, INCLUDING RETAINAGE

(Line 3 minus Line 6)

The undersigned Contractor certifies that to the best of the Contractor's knowledge, information and belief the Work covered by this Application for Payment has been completed in accordance with the Contract Documents, that all amounts have been paid by the Contractor for Work for which previous Certificates for Payment were issued and payments received from the Owner, and that current payment shown herein is now due.

CONTRACTOR:
By: _____ Date: _____
State of: _____
County of: _____
Subscribed and sworn to before me this _____ day of _____

Notary Public:
My commission expires: _____

ARCHITECT'S CERTIFICATE FOR PAYMENT
In accordance with the Contract Documents, based on on-site observations and the data comprising this application, the Architect certifies to the Owner that to the best of the Architect's knowledge, information and belief the Work has progressed as indicated, the quality of the Work is in accordance with the Contract Documents, and the Contractor is entitled to payment of the AMOUNT CERTIFIED.

AMOUNT CERTIFIED

(Attach explanation if amount certified differs from the amount applied. Initial all figures on this Application and on the Continuation Sheet that are changed to conform with the amount certified.)

ARCHITECT:
By: _____ Date: _____

This Certificate is not negotiable. The AMOUNT CERTIFIED is payable only to the Contractor named herein. Issuance, payment and acceptance of payment are without prejudice to any rights of the Owner or Contractor under this Contract.

CHANGE ORDER SUMMARY	ADDITIONS	DEDUCTIONS
Total changes approved in previous months by Owner	\$	\$
Total approved this month	\$	\$
TOTAL	\$	\$
NET CHANGES by Change Order	\$	\$

CAUTION: You should sign an original AIA Contract Document, on which this text appears in RED. An original assures that changes will not be obscured.

AIA Document G702™ – 1992. Copyright © 1953, 1963, 1965, 1971, 1978, 1983 and 1992 by The American Institute of Architects. All rights reserved. WARNING: This AIA™ Document is protected by U.S. Copyright Law and International Treaties. Unauthorized reproduction or distribution of this AIA™ Document, or any portion of it, may result in severe civil and criminal penalties, and will be prosecuted to the maximum extent possible under the law. Purchasers are permitted to reproduce ten (10) copies of this document when completed. To report copyright violations of AIA Contract Documents, e-mail The American Institute of Architects' legal counsel, copyright@aia.org. 0107140204

AIA[®] Document G703™ – 1992

Continuation Sheet

AIA Document G702™-1992, Application and Certificate for Payment, or G732™-2009, Application and Certificate for Payment, Construction Manager as Adviser Edition, containing Contractor's signed certification is attached.
 In tabulations below, amounts are in US dollars.
 Use Column I on Contracts where variable retainage for line items may apply.

APPLICATION NO:
 APPLICATION DATE:
 PERIOD TO:
 ARCHITECT'S PROJECT NO:

A ITEM NO.	B DESCRIPTION OF WORK	C SCHEDULED VALUE	D WORK COMPLETED		F MATERIALS PRESENTLY STORED <i>(Not in D or E)</i>	G TOTAL COMPLETED AND STORED TO DATE <i>(D+E-F)</i>	H BALANCE TO FINISH <i>(C-G)</i>	I RETAINAGE <i>(if variable rate)</i>
			FROM PREVIOUS APPLICATION <i>(D-E)</i>	THIS PERIOD				
<div style="font-size: 48px; opacity: 0.2; pointer-events: none;">Sample</div>								
GRAND TOTAL								

CAUTION: You should sign an original AIA Contract Document, on which this text appears in RED. An original assures that changes will not be obscured.

AIA Document G703™ – 1992. Copyright © 1963, 1965, 1966, 1967, 1970, 1978, 1983 and 1992 by The American Institute of Architects. All rights reserved. WARNING: This AIA® Document is protected by U.S. Copyright Law and International Treaties. Unauthorized reproduction or distribution of this AIA® Document, or any portion of it, may result in severe civil and criminal penalties, and will be prosecuted to the maximum extent possible under the law. Purchasers are permitted to reproduce ten (10) copies of this document when completed. To report copyright violations of AIA Contract Documents, e-mail The American Institute of Architects' legal counsel, copyright@aia.org.

END OF SECTION



Department of Public Works, Highway & Transportation
Public Works Engineering Division

608/266-4018

Gerald J. Mandli, P.E.
Commissioner / Director

Joseph T. Parisi
County Executive

Deputy Director
Todd Draper

1919 Alliant Energy Center Way
Madison, Wisconsin 53713
Fax: 608/267-1533
www.countyofdane.com/pwht/public_works.aspx

BEST VALUE CONTRACTING APPLICATION

CONTRACTORS / LICENSURE APPLICANTS

The Dane County Department of Public Works requires contractors & subcontractors to be a Best Value Contractor before being hired. Contractor & subcontractor application documents should be turned in immediately. Contractor approval or exemption must be complete prior to Bid Due Date / Time. All subcontractors must also be approved or prove their exemption before performing any work under a County contract. This document shall be completed, properly executed, along with the necessary attachments and additional information that the County requires for the protection and welfare of the public in the performance of a County contract.

Contractors or subcontractors of any tier who attain qualification status will retain that status for a period of two (2) years from the date of qualification. Contractors shall notify the Dane County Department of Public Works, Highway & Transportation within fifteen (15) days of any changes to its business or operations that are relevant to the application. Failure to do so could result in suspension, revocation of the contractor's qualification, debarment from County contracts for up to three (3) years and / or other sanctions available under the law.

No contracts will be awarded for construction work performed on Dane County projects unless the contractor is currently approved as a Wisconsin Trade Trainer or has applied for approval as an Apprenticeship Trade Trainer to the Wisconsin Department of Workforce Development and agrees to an acceptable apprenticeship program. If you are not currently approved as a Wisconsin Trade Trainer, or have not applied for approval as an Apprenticeship Trade Trainer, please contact the Department of Workforce Development - Bureau of Apprenticeship Standards at 608/266-3133 or visit their web site at: <https://dwd.wisconsin.gov/apprenticeship/>.

EXEMPTIONS

- Contractors who employ less than five (5) apprenticeable trade workers are not required to qualify.
- Contractors performing work that does not apply to an apprenticeable trade, as outlined in Appendix A.
- The contractor / subcontractor provides sufficient documentation to demonstrate one or more of the following:
 - apprentices are not available in a specific geographic area;
 - the applicable apprenticeship program is unsuitable or unavailable; or
 - there is a documented depression of the local construction market which prevents compliance.

SEC.	PROOF OF RESPONSIBILITY	CHECK IF APPLICABLE
1	Does your firm possess all technical qualifications and resources, including equipment, personnel and financial resources, necessary to perform the work required for any project or obtain the same through the use of responsible, qualified subcontractors?	Yes: <input type="checkbox"/> No: <input type="checkbox"/>
2	Will your firm possess all valid, effective licenses, registrations or certificates required by federal, state, county, or local law, which are necessary for the type of work to be performed including, but not limited to, those for any type of trade work or specialty work?	Yes: <input type="checkbox"/> No: <input type="checkbox"/>
3	Will your firm meet all bonding requirements as required by applicable law or contract specifications?	Yes: <input type="checkbox"/> No: <input type="checkbox"/>
4	Will your firm meet all insurance requirements as required by applicable law or specifications, including general liability insurance, workers compensation insurance and unemployment insurance requirements?	Yes: <input type="checkbox"/> No: <input type="checkbox"/>
5	Will your firm maintain a substance abuse policy for employees hired for public works contracts that comply with Wis. Stats. Sec. 103.503?	Yes: <input type="checkbox"/> No: <input type="checkbox"/>
6	Will your firm fully abide by the equal opportunity and affirmative action requirements of all applicable laws, including County ordinances?	Yes: <input type="checkbox"/> No: <input type="checkbox"/>
7	In the past three (3) years, has your firm had control or has another corporation, partnership or other business entity operating in the construction industry controlled it? If so, please attach a statement explaining the nature of the firm relationship?	Yes: <input type="checkbox"/> No: <input type="checkbox"/> If Yes, attach details.
8	In the past three (3) years, has your firm had any type of business, contracting or trade license, certification or registration revoked or suspended?	Yes: <input type="checkbox"/> No: <input type="checkbox"/> If Yes, attach details.
9	In the past three (3) years, has your firm been debarred by any federal, state or local government agency?	Yes: <input type="checkbox"/> No: <input type="checkbox"/> If Yes, attach details.
10	In the past three (3) years, has your firm defaulted or failed to complete any contract?	Yes: <input type="checkbox"/> No: <input type="checkbox"/> If Yes, attach details.
11	In the past three (3) years, has your firm committed a willful violation of federal, state or local government safety laws as determined by a final decision of a court or government agency authority.	Yes: <input type="checkbox"/> No: <input type="checkbox"/> If Yes, attach details.
12	In the past three (3) years, has your firm been in violation of any law relating to your contracting business where the penalty for such violation resulted in the imposition of a penalty greater than \$10,000?	Yes: <input type="checkbox"/> No: <input type="checkbox"/> If Yes, attach details.
13	Is your firm an active Wisconsin Trade Trainer as determined by the Wisconsin Bureau of Apprenticeship Standards?	Yes: <input type="checkbox"/> No: <input type="checkbox"/>
14	Is your firm exempt from being qualified with Dane County?	Yes: <input type="checkbox"/> No: <input type="checkbox"/> If Yes, attach reason for exemption.
15	Does your firm acknowledge that in doing work under any County Public Works Contract, it will be required to use as subcontractors only those contractors that are also qualified with the County or become so within five (5) days after the Bid Due Date?	Yes: <input type="checkbox"/> No: <input type="checkbox"/>
16	Contractor has been in business less than one year?	Yes: <input type="checkbox"/> No: <input type="checkbox"/>
17	Is your firm a first time Contractor requesting a one time exemption, but, intend to comply on all future contracts and are taking steps typical of a "good faith" effort?	Yes: <input type="checkbox"/> No: <input type="checkbox"/>

SIGNATURE SECTION

Your firm's Officer, or the individual who would sign a bid and / or contract documents must sign this document.

I do hereby certify that all statements herein contained are true and correct to the best of my knowledge:

Signature: _____

(Application is invalid without signature)

Print Name: _____ Date: _____

Title: _____

NAME AND ADDRESS OF CONTRACTOR	
Name of Firm:	
Address:	
City, State, Zip:	
Phone Number:	
Fax Number:	
E-mail Address:	

REMEMBER!

RETURN ALL TO FORMS AND ATTACHMENTS, OR QUESTIONS TO:

**TODD DRAPER
EMAIL: DRAPER@COUNTYOFDANE.COM
OFFICE: (608) 267-0119, FAX: (608) 267-1533**

**DANE COUNTY DEPARTMENT OF PUBLIC WORKS, HIGHWAY & TRANSPORTATION
1919 ALLIANT ENERGY CENTER WAY
MADISON, WI 53713**

APPENDIX A

APPRENTICEABLE TRADES:

- Bricklayer
- Carpenter
- Cement Mason (Concrete Finisher)
- Cement Mason (Heavy Highway)
- Construction Craft Laborer
- Data Communications Installer
- Electrician
- Elevator Mechanic / Technician
- Environmental Systems Technician / HVAC Service Technician / HVAC Install & Service
- Glazier
- Heavy Equipment Operator / Operating Engineer
- Insulation Worker (Heat & Frost)
- Iron Worker (Assembler, Metal Buildings)
- Painter / Decorator
- Plasterer
- Plumber
- Roofer / Waterproofer
- Sheet Metal Worker
- Sprinkler Fitter
- Steamfitter (Service & Refrigeration)
- Taper & Finisher
- Telecommunications (Voice, Data & Video) Installer / Technician
- Tile Setter

END OF SECTION

SECTION 00 73 11

FAIR LABOR PRACTICES CERTIFICATION

The undersigned, for and on behalf of the BIDDER, APPLICANT or PROPOSER named herein, certifies as follows:

A. That he or she is an officer or duly authorized agent of the above-referenced BIDDER, APPLICANT or PROPOSER, which has a submitted a bid, application or proposal for a contract or agreement with the county of Dane.

B. That BIDDER, APPLICANT or PROPOSER has (check one):

_____ not been found by the National Labor Relations Board (“NLRB”) or the Wisconsin Employment Relations Commission (“WERC”) to have violated any statute or regulation regarding labor standards or relations in the seven years prior to the signature date of this Certification.

_____ been found by the National Labor Relations Board (“NLRB”) or the Wisconsin Employment Relations Commission (“WERC”) to have violated any statute or regulation regarding labor standards or relations in the seven years prior to the signature date of this Certification.

Officer or Authorized Agent Signature

Date

Printed or Typed Name and Title

Printed or Typed Business Name

NOTE: You can find information regarding the violations described above at: www.nlrb.gov and werc.wi.gov.

For reference, Dane County Ordinance 25.09 is as follows:

(1) BIDDER RESPONSIBILITY. (a) Any bid, application or proposal for any contract with the county, including public works contracts regulated under chapter 40, shall include a certification indicating whether the bidder has been found by the National Labor Relations Board (NLRB) or the Wisconsin Employment Relations Committee (WERC) to have violated any statute or regulation regarding labor standards or relations within the last seven years. The Controller shall investigate any such finding and make a recommendation to the committee, which shall determine whether the conduct resulting in the finding affects the bidder’s responsibility to perform the contract.

If you indicated that the NLRB or WERC have found you to have such a violation, you must include copies of any relevant information regarding such violation with your proposal, bid or application.

Include this completed Certification with your bid, application or proposal.

END OF SECTION

SECTION 01 00 00

GENERAL REQUIREMENTS

PART 1 GENERAL

1.1 SUMMARY

- A. Section Includes:
1. Summary
 2. Summary of the Work
 3. Contractor Use of Premises
 4. Applications for Payment
 5. Change Procedures
 6. Alternates
 7. Lump Sum Allowances for Work
 8. Coordination
 9. Cutting and Patching
 10. Conferences
 11. Progress Meetings
 12. Job Site Administration
 13. Submittal Procedures
 14. Proposed Products List
 15. Shop Drawings
 16. Product Data
 17. Samples
 18. Manufacturers' Instructions
 19. Manufacturers' Certificates
 20. Quality Assurance / Quality Control of Installation
 21. References
 22. Interior Enclosures
 23. Protection of Installed Work
 24. Parking
 25. Staging Areas
 26. Occupancy During Construction and Conduct of Work
 27. Protection
 28. Progress Cleaning
 29. Products
 30. Transportation, Handling, Storage and Protection
 31. Product Options
 32. Substitutions
 33. Starting Systems
 34. Demonstration and Instructions
 35. Contract Closeout Procedures
 36. Final Cleaning
 37. Adjusting
 38. Operation and Maintenance Data
 39. Spare Parts and Maintenance Materials

40. As-Built and Record Drawings and Specifications

1.2 SUMMARY OF THE WORK

- A. Project Description: Perform the Work as specified and detailed in Construction Documents package. Contractor to provide mechanical piping and high pressure tubing for a new compressed natural gas (CNG) system.....
- B. Work by Owner:
 - 1. Sawcutting, trenching, backfilling.
 - 2. Electrical conduit, wiring and connections.
- C. Permits: Prior to commencement of the Work, Contractor to secure any and all necessary permits for completion of the Work and facility occupancy. Provide [Public Works, Waste & Renewables] Project Manager with copies of all permits.
- D. Diggers Hotline:
 - 1. It is General Contractor's responsibility to contact Diggers Hotline to have all utility locations marked prior to excavation and planning excavation so as not to delay the Work.
 - 2. Diggers Hotline shall also be used to obtain information on safe working clearances from overhead lines.
 - 3. Completely comply with all requirements of each affected utility company.
 - 4. It is General Contractor's responsibility to contact & hire private utility locating services if necessary.

1.3 CONTRACTOR USE OF PREMISES

- A. Limit use of premises to allow work by others and work by Owner.
- B. Coordinate utility outages and shutdowns with Owner.

1.4 APPLICATIONS FOR PAYMENT

- A. Submit one (1) original copies with "wet" signatures of each application on AIA G702™ and G703™ forms or approved contractors invoice form.
- B. Content and Format: Utilize Schedule of Values for listing items in Application for Payment.
- C. Payment Period: Monthly.
- D. Submit Applications for Payment to Public Works Project Manager for approval & processing for payment.

1.5 CHANGE PROCEDURES

- A. Contractor's costs for Products, delivery, installation, labor, insurance, payroll, taxes, bonding, equipment rental, overhead and profit will be included in Change Orders authorizing expenditure of funds from contingency allowance.

1.6 ALTERNATES

- A. Alternates quoted on Bid Form shall be reviewed and accepted or rejected at Owner's option.
- B. Coordinate related work and modify surrounding work as required.
- C. Schedule of Alternates: there are no alternates proposed for this project.

1.7 LUMP SUM ALLOWANCES FOR WORK

- A. Not Used.

1.8 COORDINATION

- A. Coordinate scheduling, submittals, and work of various sections of Specifications to assure efficient and orderly sequence of installation of interdependent construction elements.
- B. Verify utility requirement characteristics of operating equipment are compatible with building utilities.
- C. Coordinate space requirements and installation of mechanical and electrical work that are indicated diagrammatically on Drawings.
- D. Contractor shall provide Public Works Project Manager with work plan that ensures the Work will be completed within required time of completion.
- E. Public Works Project Manager may choose to photograph or videotape site or workers as the Work progresses.

1.9 CUTTING AND PATCHING

- A. Employ skilled and experienced installer to perform cutting and patching new work; restore work with new Products.
- B. Submit written request in advance of cutting or altering structural or building enclosure elements.
- C. Fit work tight to adjacent elements. Maintain integrity of wall, ceiling, or floor construction; completely seal voids.
- D. Refinish surfaces to match adjacent finishes.

1.10 CONFERENCES

- A. Project shall have pre-bid conference; see Instructions to Bidders.
- B. Owner will schedule preconstruction conference after Award of Contract for all affected parties.
- C. Contractor shall submit Construction Schedule at pre-construction meeting.
- D. When required in individual Specification section, convene pre-installation conference at project site prior to commencing work of Section.
- E. Safe distancing & face masks are required for all conference attendees. Conferences will be limited to 10 people; please limit number of attending staff & subcontractors. If there are more than 10 people, group will be split & there will be two or more conferences. Allow sufficient time if you do not make it in to first group.

1.11 PROGRESS MEETINGS

- A. Day & time of progress meetings to be determined at pre-construction meeting.
- B. Preside at meetings, record minutes, and distribute copies within two (2) business days to those affected by decisions made.
- C. Attendance at progress meetings by General Contractor, subcontractors, or their authorized representative, is mandatory.
- D. Contractors shall give verbal reports of progress on the Work, discuss schedule for upcoming period and present all conflicts, discrepancies or other difficulties for resolution.
- E. In-person meetings shall be limited & shall follow current *Public Health - Madison & Dane County* procedures & recommendations (see publichealthmdc.com/documents/office_space_checklist.pdf and publichealthmdc.com/coronavirus/forward-dane/current-order). Whenever possible, meetings shall be held via teleconference or videoconference, to be hosted by contractor or consultant. Dane County reserves right to mandate safe physical distancing & use of face masks by all personnel while inside any County facility or on any County grounds.

1.12 JOB SITE ADMINISTRATION

- A. Contractor shall have project superintendent on site minimum of four (4) hours per day, during progress of the Work.
- B. Contractor shall not change their project superintendent or project manager for duration of the Work without written permission of Public Works Project Manager.

1.13 SUBMITTAL PROCEDURES

- A. Submittal form to identify Project, Contractor, Subcontractor or supplier; and pertinent Construction Documents references.
- B. Apply Contractor's stamp, signed or initialed, certifying that review, verification of Products required, field dimensions, adjacent construction work, and coordination of information is in accordance with requirements of the Work and Construction Documents.
- C. Identify variations from Construction Documents and Product or system limitations that may be detrimental to successful performance of completing the Work.
- D. Revise and resubmit submittals as required; identify all changes made since previous submittal.

1.14 PROPOSED PRODUCTS LIST

- A. Within fifteen (15) business days after date of Award of Contract, submit complete list of major Products proposed for use, with name of manufacturer, trade name, and model number of each Product.

1.15 SHOP DRAWINGS

- A. Submit number of copies that Contractor requires, plus three (3) copies that shall be retained by Public Works, Project Manager.

1.16 PRODUCT DATA

- A. Submit number of copies that Contractor requires, plus two (2) copies that shall be retained by Public Works Project Manager.
- B. Mark each copy to identify applicable products, models, options, and other data. Supplement manufacturer's standard data to provide information unique to this Project.

1.17 SAMPLES

- A. Submit samples to illustrate functional and aesthetic characteristics of Product.
- B. Submit samples of finishes from full range of manufacturers' standard colors, textures, and patterns for Public Works Project Manager's selection.

1.18 MANUFACTURERS' INSTRUCTIONS

- A. When specified in individual Specification sections, submit manufacturers' printed instructions for delivery, storage, assembly, installation, start-up, adjusting, and finishing, in quantities specified for Product Data.

1.19 MANUFACTURERS' CERTIFICATES

- A. When specified in individual Specification sections, submit manufacturers' certificate to Public Works Project Manager for review, in quantities specified for Product Data.
- B. Indicate material or Product conforms to or exceeds specified requirements. Submit supporting reference data, affidavits, and certifications as appropriate.

1.20 QUALITY ASSURANCE / QUALITY CONTROL OF INSTALLATION

- A. Monitor quality control over suppliers, manufacturers, Products, services, site conditions, and workmanship, to produce work of specified quality.
- B. Comply fully with manufacturers' instructions.
- C. Comply with specified standards as minimum quality for the Work except when more stringent tolerances, codes, or specified requirements indicate higher standards or more precise workmanship.

1.21 REFERENCES

- A. Conform to reference standard by date of issue current as of date for receiving bids.
- B. Should specified reference standard conflict with Construction Documents, request clarification from Public Works Project Manager before proceeding.

1.22 INTERIOR ENCLOSURES

- A. Provide temporary partitions as required to separate work areas from Owner occupied areas, to prevent distribution of dust and moisture into Owner occupied areas, and to prevent damage to existing materials and equipment.

1.23 PROTECTION OF INSTALLED WORK

- A. Protect installed work and provide special protection where specified in individual Specification sections.

1.24 PARKING

- A. Arrange for temporary parking areas to accommodate construction personnel. Parking shall be available at the Work site,
- B. All contractors and their employees shall cooperate with General Contractor and others in parking of vehicles to avoid interference with normal operations and construction activities.
- C. Do not obstruct existing service drives and parking lots with equipment, materials and / or vehicles. Keep accessible for Owner's use at all times.

1.25 STAGING AREAS

- A. Coordinate staging areas with Public Works Project Manager prior to starting the Work.
- B. On-site space for use as staging areas and storage of materials is limited and will be apportioned among various Contractors as their needs dictate with due regard for storage requirements of each Contractor. Each Contractor shall be responsible for safety of equipment and materials that are stored on site.

1.26 OCCUPANCY DURING CONSTRUCTION AND CONDUCT OF WORK

- A. Contractors are asked to not work at facility if they are ill with something contagious.
- B. All contractors are expected to leave work areas in conditions; such that area can be occupied immediately upon leaving area.
- C. Smoking is prohibited on Dane County property.
- D.
- E. Owner reserves right at any time to dismiss from premises any Contractor or construction personnel that do not uphold requirements of this Section.
- F. Owner shall not be held liable for any lost time, wages, or impacts to construction schedule by any Contractor or construction personnel dismissed for failure to uphold requirements of this Section.
- G. Each Contractor shall arrange with Owner to make necessary alterations, do new work, make connections to all utilities, etc., and at such times as will not cause interruption of utility services to facility. Contractor doing this work shall protect, cap, cut off and / or replace and relocate existing pipes, electrical work and other active utilities encountered which may interfere with new construction work.
- H. New work in extension of existing work shall correspond in all respects with that to which it connects or similar existing work unless otherwise indicated or specified.
 - 1. Existing work shall be cut, altered, removed or replaced as necessary for performance of Contract obligations.
 - 2. Work remaining in place, damaged or defaced by reason of work done under this Contract shall be restored equal to its condition at time of Award of Contract.
 - 3. If removal of work exposes discolored or unfinished surfaces or work out of alignment, such surfaces shall be refinished or materials replaced as necessary to make continuous work uniform and harmonious.
- I. Contractor is responsible for providing & maintaining temporary toilet facilities.
- J. Contractor & subcontractors shall follow all current *Public Health - Madison & Dane County* procedures & recommendations (see publichealthmdc.com/documents/office_space_checklist.pdf and

publichealthmdc.com/coronavirus/forward-dane/current-order). Dane County reserves right to mandate safe physical distancing & use of face masks by all personnel while inside any County facility or on any County grounds.

1.27 PROTECTION

- A. Contractor shall protect from damage / injury all trees, shrubs, hedges, plantings, grass, mechanical, electrical & plumbing equipment, walks and driveways and pay for any damage to same resulting from insufficient or improper protection.
- B. Contractor shall provide and maintain barricades & signage to prohibit public access to construction site.
- C. Contractor shall provide and maintain guard lights at all barricades, railings, obstructions in streets, roads or sidewalks and at all trenches adjacent to public walks or roads.

1.28 PROGRESS CLEANING

- A. Maintain areas free of waste materials, debris, and rubbish. Maintain site in clean and orderly condition.

1.29 PRODUCTS

- A. Products: Means new material, machinery, components, equipment, fixtures, and systems forming the Work, but does not include machinery and equipment used for preparation, fabrication, conveying and erection of the Work. Products may also include existing materials or components specifically identified for reuse.
- B. Do not use materials and equipment removed from existing premises, except as specifically identified or allowed by Construction Documents.

1.30 TRANSPORTATION, HANDLING, STORAGE AND PROTECTION

- A. Transport, handle, store and protect Products in accordance with manufacturer's instructions.

1.31 PRODUCT OPTIONS

- A. Where definite material is specified, it is not intentional to discriminate against "equal" product made by another manufacturer. Intention is to set definite standard of material quality. Should bidder choose to bid materials other than those specified, bidder shall submit said materials specifications to Public Works, Waste & Renewables] Project Manager for approval at least seven (7) business days prior to Bid Due Date.
- B. Products and materials that are not specified, but have been approved for use by Public Works Project Manager shall be identified in addenda to all bidding contractors.

- C. Requests for material or product substitutions submitted after Bid Due Date may be considered. Owner reserves right to approve or reject substitutions based on Specification requirements and intended use.

1.32 SUBSTITUTIONS

- A. Public Works, Waste & Renewables Project Manager shall consider requests for Substitutions only within fifteen (15) calendar days after date of Public Works Construction Contract.
- B. Document each request with complete data substantiating compliance of proposed Substitution with Construction Documents.
- C. Submit three (3) copies of requests for Substitution for consideration. Limit each request to one (1) proposed Substitution.
- D. Substitutions shall not change contract price established at Bid Due Date.

1.33 STARTING SYSTEMS

- A. Provide written notification prior to start-up of each equipment item or system.
- B. Ensure that each piece of equipment or system is ready for operation.
- C. Execute start-up under supervision of responsible persons in accordance with manufacturers' instructions.
- D. Submit written report that equipment or system has been properly installed and is functioning correctly.

1.34 DEMONSTRATION AND INSTRUCTIONS

- A. Demonstrate operation and maintenance of Products to Owner's personnel prior to date of final inspection.
- B. Demonstrate start-up, operation, control, adjustment, trouble-shooting, servicing, maintenance, and shutdown of each item of equipment at agreed-upon times, at designated location.
- C. Owner may choose to photograph or videotape demonstration session; demonstration and demonstrator shall be to level of satisfaction of Owner.

1.35 CONTRACT CLOSEOUT PROCEDURES

- A. Submit written certification that Construction Documents have been reviewed, the Work has been inspected, and the Work is complete in accordance with Construction Documents and ready for Public Works Project Manager's inspection.

- B. Submit final Application for Payment identifying total adjusted Contract Sum / Price, previous payments, and amount remaining due.
- 1.36 FINAL CLEANING
- A. Execute final cleaning prior to final inspection.
 - B. Clean interior and exterior surfaces exposed to view.
 - C. Remove waste and surplus materials, rubbish, and construction facilities from site.
- 1.37 ADJUSTING
- A. Adjust operating Products and equipment to ensure smooth and unhindered operation.
- 1.38 OPERATION AND MAINTENANCE MANUAL
- A. Provide two (2) bound, hard-copy operation and maintenance manuals that include all systems, materials, products, equipment, mechanical and electrical equipment and systems supplied and installed in the Work. Provide electronic version of operation and maintenance manual also.
- 1.39 SPARE PARTS AND MAINTENANCE MATERIALS
- A. Provide Products, spare parts, maintenance and extra materials in quantities specified in individual Specification Sections.
 - B. Deliver to the Work site and place in location as directed.
- 1.40 AS-BUILT AND RECORD DRAWINGS AND SPECIFICATIONS
- A. Contractor-produced Drawings and Specifications shall remain property of Contractor whether Project for which they are made is executed or not. Contractor shall furnish Engineer Public Works Project Manager with original marked up redlines of Construction Documents' drawings and specifications that shall include all Addendums, Change Orders, Construction Bulletins, on-site changes, field corrections, etc. These are project As-Built Drawings & Specifications.[Record Drawings & Specifications shall be created from these As-Built by Public Works, Waste & Renewables.
 - B. Engineer shall update original Construction Documents to include all Addendums & any other changes including those provided by Contractor in As-Built Drawings & Specifications. These updates are project Record Drawings & Specifications.
 - C. Engineer shall furnish Public Works Project Manager with Record Drawings as detailed in Professional Services Agreement.

PART 2 PRODUCTS

Not Used.

PART 3 EXECUTION

Not Used.

END OF SECTION

SECTION 01 74 19

CONSTRUCTION WASTE MANAGEMENT, DISPOSAL & RECYCLING

PART 1 GENERAL

1.1 SUMMARY

- A. Section Includes:
 - 1. Summary
 - 2. Waste Management Goals
 - 3. Construction and / or Demolition Waste Management
 - 4. Waste Management Plan
 - 5. Reuse
 - 6. Recycling
 - 7. Materials Sorting and Storage On Site
 - 8. Lists of Recycling Facilities Processors and Haulers
 - 9. Waste Management Plan Form
- B. Related Sections:
 - 1. Section 01 00 00 - General Requirements

1.2 WASTE MANAGEMENT GOALS

- A. Dane County requires that as many waste materials as possible produced as result of this project be salvaged, reused or recycled in order to minimize impact of construction waste on landfills and to minimize expenditure of energy and cost in fabricating new materials. Additional information may be found in Dane County Green Building Policy, Resolution 299, 1999-2000.

1.3 CONSTRUCTION AND / OR DEMOLITION WASTE MANAGEMENT

- A. All construction and demolition waste suitable for recycling [may, must] go to Dane County Construction & Demolition Recycling Facility located at 7102 US Hwy 12, Madison, located across from Yahara Hills Golf Course. This facility can receive mixed loads of construction and demolition waste. For complete list of acceptable materials see www.countyofdane.com/pwht/recycle/CD_Recycle.aspx.
- B. Dane County Landfill, also at 7102 US Hwy 12, Madison, must receive all other waste from this project. www.countyofdane.com/pwht/recycle/landfill.aspx.

1.4 WASTE MANAGEMENT PLAN

- A. Contractor shall develop Waste Management Plan (WMP) for this project. Dane County's Special Projects & Materials Manager may be contacted with questions. Outlined in RECYCLING section of this specification are examples of materials that can be recycled or reused as well as recommendations for waste sorting methods.
- B. Contractor shall complete WMP and include cost of recycling / reuse in Bid. WMP will be submitted to Public Works Project Manager within fifteen (15)

business days of Bid Due date. Copy of blank WMP form is in this Section. Submittal shall include cover letter and WMP form with:

1. Information on:
 - a. Types of waste materials produced as result of work performed on site;
 - b. Estimated quantities of waste produced;
 - c. Identification of materials with potential to be recycled or reused;
 - d. How materials will be recycled or reused;
 - e. On-site storage and separation requirements (on site containers);
 - f. Transportation methods; and
 - g. Destinations.

1.5 REUSE

- A. Contractors and subcontractors are encouraged to reuse as many waste materials as possible. Salvage should be investigated for materials not reusable on site.

1.6 RECYCLING

- A. These materials may be recycled at Dane County Construction & Demolition Recycling Facility:
 1. Wood.
 2. Wood Pallets.
 3. PVC Plastic (pipe, siding, etc.).
 4. Asphalt & Concrete.
 5. Bricks & Masonry.
 6. Vinyl Siding.
 7. Cardboard.
 8. Metal.
 9. Unpainted Gypsum Drywall.
 10. Shingles.
- B. These materials can be recycled elsewhere in Dane County area:
 1. Fluorescent Lamps.
 2. Foam Insulation & Packaging (extruded and expanded).
 3. Carpet Padding.
 4. Barrels & Drums.
- C. All materials must be recycled at WDNR permitted waste processing facilities that adhere to all State Statutes.

1.7 MATERIALS SORTING AND STORAGE ON SITE

- A. Contractor shall provide separate containers for recyclable materials. Number of containers will be dependent upon project and site conditions.
- B. Contractor shall provide on-site locations for subcontractors supplied recycling containers to help facilitate recycling.
- C. Mixed loads of recycled materials are allowed only per instructions at www.countyofdane.com/pwht/recycle/CD_Recycle.aspx.

1.8 LISTS OF RECYCLING FACILITIES PROCESSORS AND HAULERS

- A. Refer to www.countyofdane.com/pwht/recycle/CD_Recycle.aspx for information on Dane County Construction & Demolition Recycling Facility.
- B. Web site www.countyofdane.com/pwht/recycle/categories.aspx lists current information for Dane County Recycling Markets. Contractors can also contact Allison Rathsack at 608/266-4990, or local city, village, town recycling staff listed at site www.countyofdane.com/pwht/recycle/contacts.aspx. Statewide listings of recycling / reuse markets are available from UW Extension at <https://www.uwgb.edu/shwec/>.

PART 2 PRODUCTS

Not Used.

PART 3 EXECUTION

Not Used.

END OF SECTION

WASTE MANAGEMENT PLAN FORM



Contractor Name: _____

Address: _____

Phone No.: _____ Recycling Coordinator: _____

MATERIAL	ESTIMATED QUANTITY	DISPOSAL METHOD (CHECK ONE)	RECYCLING / REUSE COMPANY OR DISPOSAL SITE
Salvaged & reused building materials	_____ cu. yds. _____ tons	____ Recycled ____ Reused ____ Landfilled ____ Other	Name: _____
Wood	_____ cu. yds. _____ tons	____ Recycled ____ Reused ____ Landfilled ____ Other	Name: _____
Wood Pallets	_____ units	____ Recycled ____ Reused ____ Landfilled ____ Other	Name: _____
PVC Plastic	_____ cu. ft. _____ lbs.	____ Recycled ____ Reused ____ Landfilled ____ Other	Name: _____
Asphalt & Concrete	_____ cu. ft. _____ lbs.	____ Recycled ____ Reused ____ Landfilled ____ Other	Name: _____
Bricks & Masonry	_____ cu. ft. _____ lbs.	____ Recycled ____ Reused ____ Landfilled ____ Other	Name: _____
Vinyl Siding	_____ cu. ft. _____ lbs.	____ Recycled ____ Reused ____ Landfilled ____ Other	Name: _____
Cardboard	_____ cu. ft. _____ lbs.	____ Recycled ____ Reused ____ Landfilled ____ Other	Name: _____
Metals	_____ cu. yds. _____ tons	____ Recycled ____ Reused ____ Landfilled ____ Other	Name: _____
Unpainted Gypsum / Drywall	_____ cu. yds. _____ tons	____ Recycled ____ Reused ____ Landfilled ____ Other	Name: _____
Shingles	_____ cu. yds. _____ tons	____ Recycled ____ Reused ____ Landfilled ____ Other	Name: _____
Fluorescent Lamps	_____ cu. ft. _____ lbs.	____ Recycled ____ Reused ____ Landfilled ____ Other	Name: _____
Foam Insulation	_____ cu. ft. _____ lbs.	____ Recycled ____ Reused ____ Landfilled ____ Other	Name: _____
Carpet Padding	_____ cu. ft. _____ lbs.	____ Recycled ____ Reused ____ Landfilled ____ Other	Name: _____
Barrels & Drums	_____ units	____ Recycled ____ Reused ____ Landfilled ____ Other	Name: _____
Glass	_____ cu. yds. _____ tons	____ Recycled ____ Reused ____ Landfilled ____ Other	Name: _____

WASTE MANAGEMENT PLAN FORM

Other	_____	<input type="checkbox"/> Recycled <input type="checkbox"/> Reused <input type="checkbox"/> Landfilled <input type="checkbox"/> Other	Name: _____
Other	_____	<input type="checkbox"/> Recycled <input type="checkbox"/> Reused <input type="checkbox"/> Landfilled <input type="checkbox"/> Other	Name: _____
Other	_____	<input type="checkbox"/> Recycled <input type="checkbox"/> Reused <input type="checkbox"/> Landfilled <input type="checkbox"/> Other	Name: _____
Other	_____	<input type="checkbox"/> Recycled <input type="checkbox"/> Reused <input type="checkbox"/> Landfilled <input type="checkbox"/> Other	Name: _____
Other	_____	<input type="checkbox"/> Recycled <input type="checkbox"/> Reused <input type="checkbox"/> Landfilled <input type="checkbox"/> Other	Name: _____

CONSTRUCTION PLAN SET

DANE COUNTY HIGHWAY FACILITY CNG FUELING FACILITY EXPANSION

PREPARED FOR:

DANE COUNTY DEPARTMENT OF WASTE & RENEWABLES MADISON, WISCONSIN

OCTOBER 2020

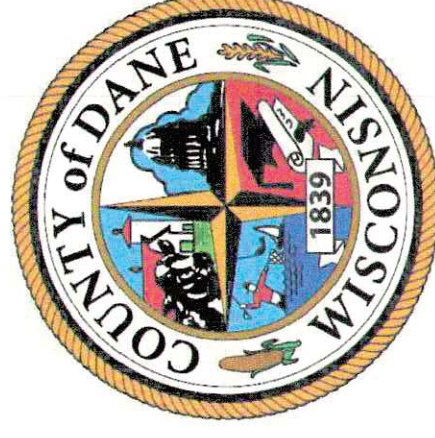

**PREPARED
BY:**



TETRA TECH

8413 EXCELSIOR DRIVE
SUITE 160
MADISON, WISCONSIN, 53717
Tel. (877) 294-9070

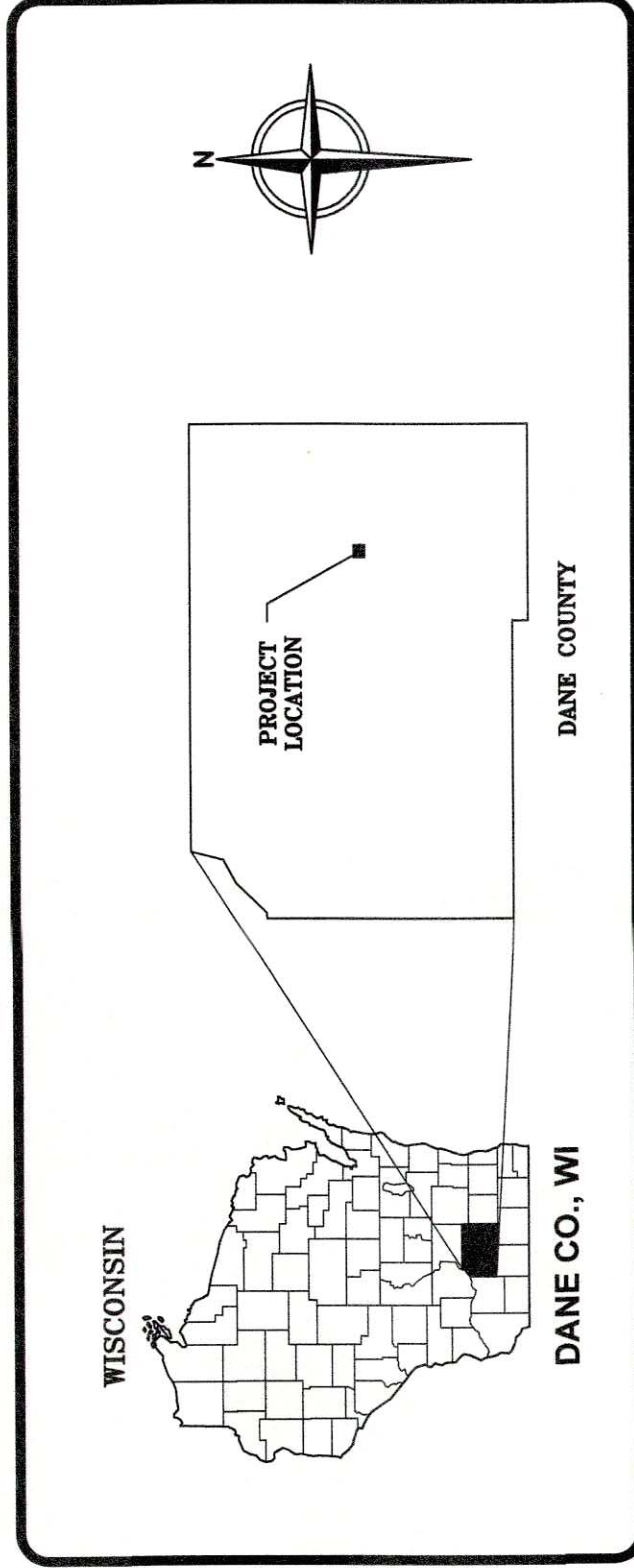
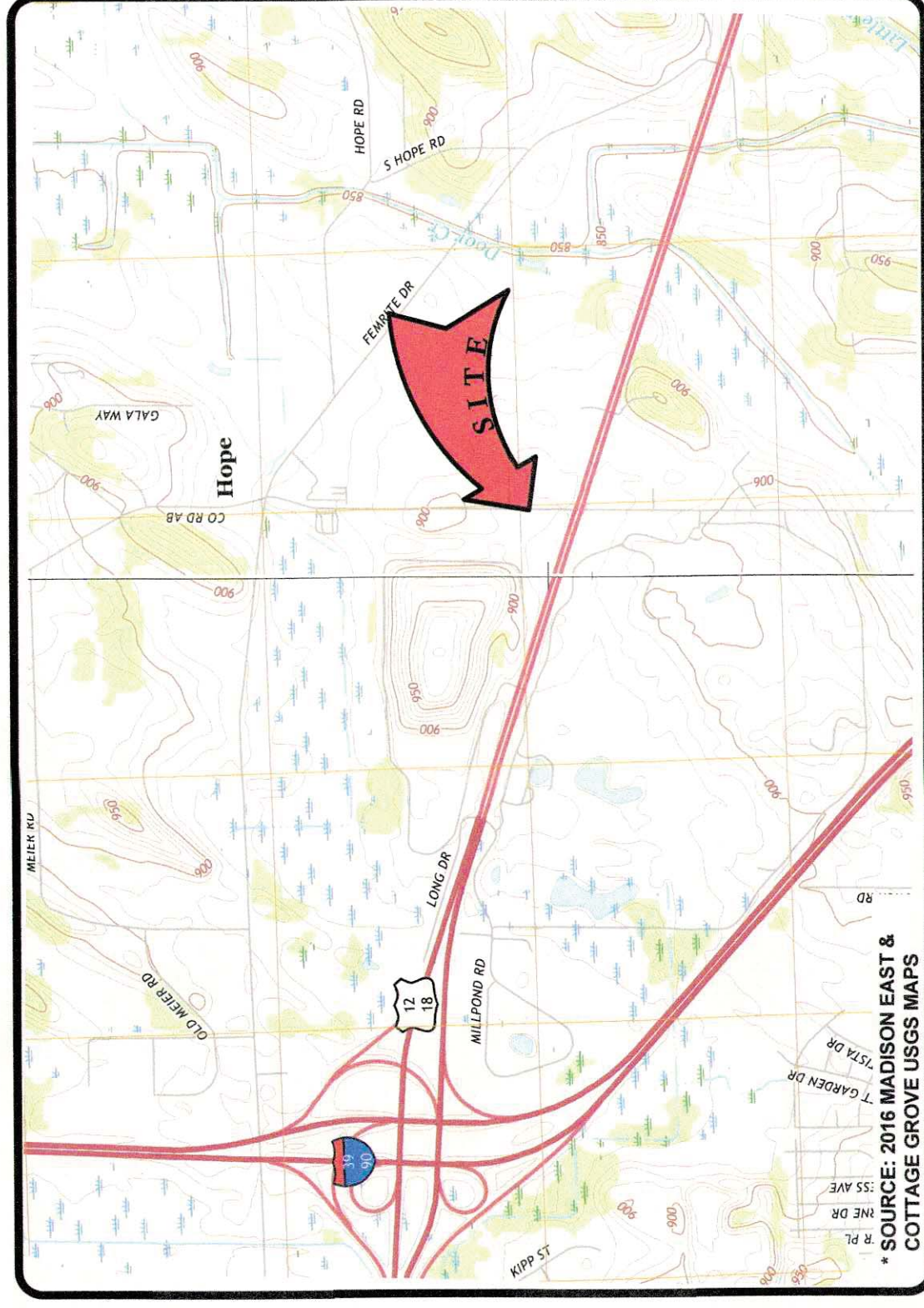

LOCATION MAP

INDEX OF DRAWINGS



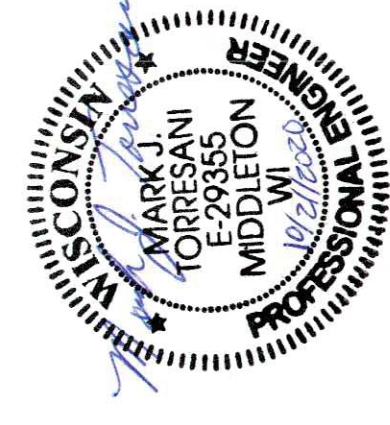

01	COVER SHEET
C-1	SITE LAYOUT
C-2	SITE PLAN
M-1	MECHANICAL PIPING LAYOUT
M-2	HIGH PRESSURE TUBING LAYOUT
M-3	UTILITY PIPING ISOMETRIC LAYOUT
02	CIVIL AND MECHANICAL DETAILS
E1	ONE-LINE
E10	POWER AND CONDUIT PLAN
E11	CONDUIT DETAILS
E20	GROUNDING PLAN
E21	GROUNDING DETAILS



This drawing represents intellectual property of Tetra Tech. Any modification to the original by other than Tetra Tech, its employees, agents, consultants, and subcontractors, without the express written consent of Tetra Tech, shall be the responsibility of the user. Tetra Tech will not be held liable for any changes made to this document without express written consent of the originator.

ISSUED FOR BID

LEGEND

-  EXISTING CANOPY OR BUILDING
-  EXISTING CONCRETE PAD OR PAVEMENT
-  EXISTING ELECTRICAL CONDUIT
-  PROPOSED CONCRETE SLAB
-  PROPOSED ELECTRICAL CONDUIT

NOTES:

1. EXISTING CANOPY, CONCRETE AREAS, ELECTRICAL CONDUIT LINES ARE FROM A CAD FILE TITLED "Dane County Public Works_A-102 - Site Plan - Phase 1_112019.DWG" SUPPLIED BY DANE COUNTY.
2. SLEEPER SUPPORTS WITH 10' - 14' SPACING. 1-RD WITH UBOLT HOLD DOWNS PER TYPICAL DETAIL MPS-022C.
3. MAINTAIN A MINIMUM 48" OF CLEARANCE FROM THE COMPRESSOR BUILDING OUTSIDE WALL TO THE NEAREST OBSTRUCTION INCLUDING PIPING AND ELECTRICAL RACEWAY. CONSIDER EQUIPMENT ACCESS NEEDED FOR REMOVAL OF COOLER. USE COMMON SUPPORTS AND BOTTOM OF PIPE ELEVATIONS FOR COMPRESSOR INLET AND OUTLET PIPING.
4. PIPING AND TUBING INSTALLATION, FABRICATION, WELDING INSPECTION, AND TESTING TO BE IN ACCORDANCE WITH ASME B31.3, NORMAL FLUID SERVICE.
5. CONTRACTOR TO FIELD VERIFY DIMENSIONS AND INTERFACE POINTS
6. ALL WELDS INDICATED AT "FFW" TO HAVE 6" ADDED TO CUT LENGTH.
7. CONTRACTOR TO ERECT ALL SPOOL PIECES PRIOR TO ADJUSTING "FFW"
8. CONTRACTOR IS RESPONSIBLE FOR PROVIDING CONNECTIONS, MATERIALS, AND RELIEF DEVICES NECESSARY TO PERFORM LEAK TEST.
9. PNEUMATIC TESTING REQUIRES SPECIAL CONSIDERATIONS. CONSULT ENGINEERING FOR RECOMMENDATIONS.
10. MATERIAL SUBSTITUTIONS BY CONTRACTOR ALLOWED ONLY IF PROVIDED IN WRITING BY ENGINEERING.

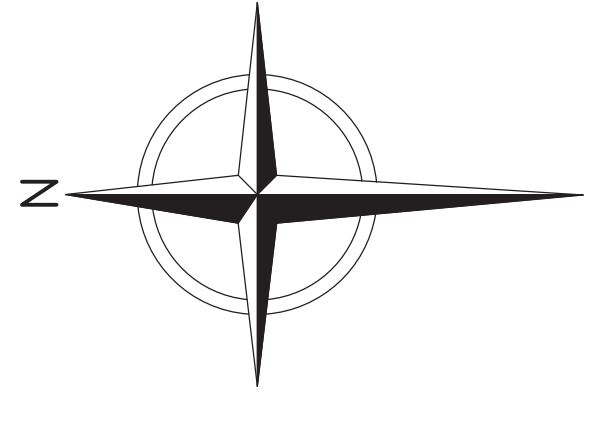

ISSUED FOR BID

SHEET NO. **C-1**
PROJECT NO. 4201306

COUNTY OF DANE, DEPT. OF PUBLIC WORKS
RODEFELD LANDFILL
DANE COUNTY, WISCONSIN
**DANE COUNTY FUELING FACILITY EXPANSION
SITE PLAN**





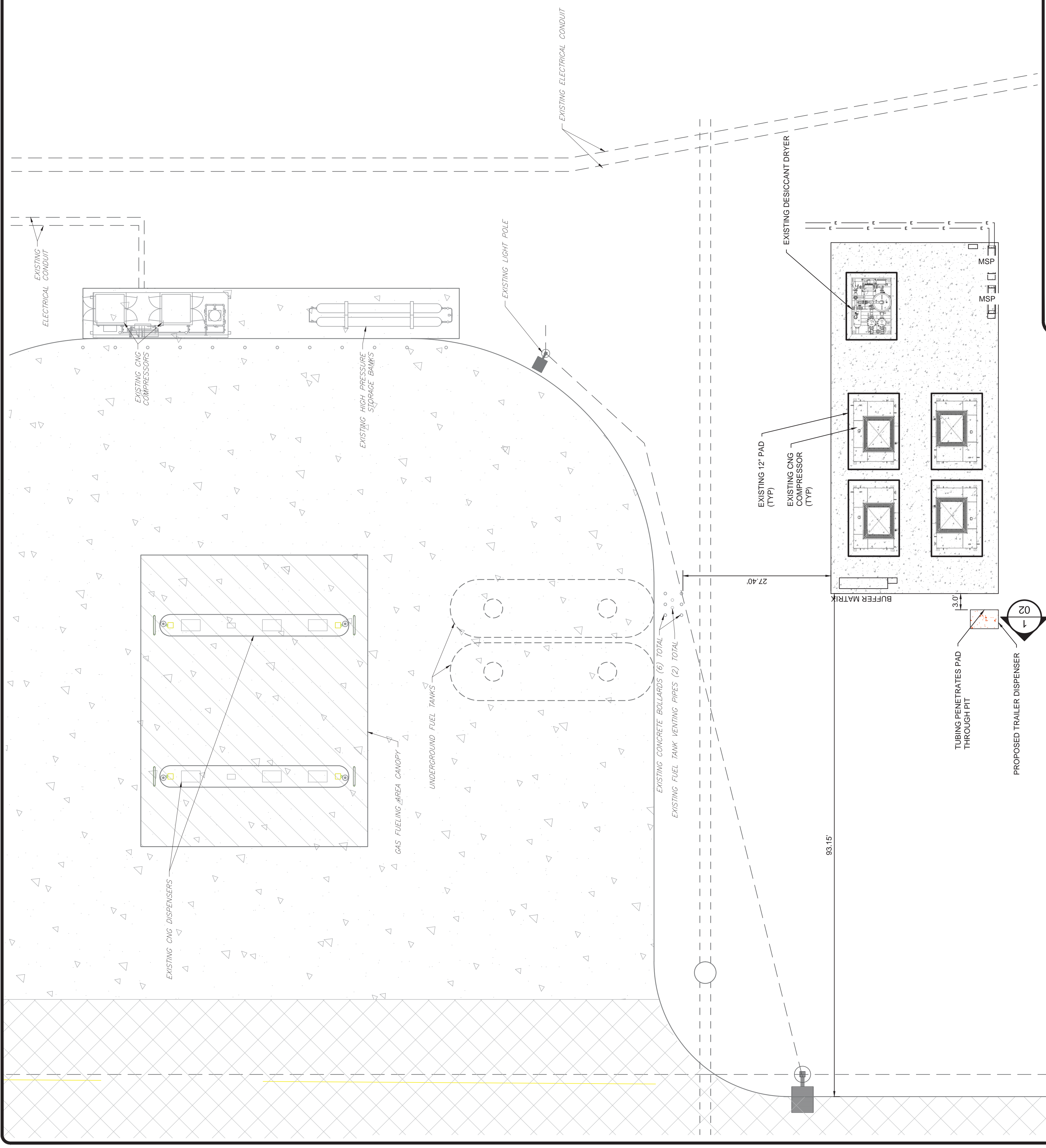

REV.	DATE	DESCRIPTION	DES. BY	CHK. BY	APP. BY
1	10/21/2020	SIC/RME	BB	BB	MUT



1" = 10'0"

LEGEND

-  EXISTING CANOPY OR BUILDING
-  EXISTING CONCRETE PAD OR PAVEMENT
-  EXISTING ELECTRICAL CONDUIT
-  PROPOSED CONCRETE SLAB
-  PROPOSED ELECTRICAL CONDUIT

NOTES:

1. EXISTING CANOPY, CONCRETE AREAS, ELECTRICAL CONDUIT LINES ARE FROM A CAD FILE TITLED "Dane County Public Works_A-102 - Site Plan - Phase 1_112019.DWG" SUPPLIED BY DANE COUNTY.
2. SLEEPER SUPPORTS WITH 10" x 14" SPACING. I-ROD WITH UBOLT HOLD DOWNS PER TYPICAL DETAIL MPS-022C.
3. MAINTAIN A MINIMUM 48" OF CLEARANCE FROM THE COMPRESSOR BUILDING OUTSIDE WALL TO THE NEAREST OBSTRUCTION INCLUDING PIPING AND ELECTRICAL RACEWAY. CONSIDER EQUIPMENT ACCESS NEEDED FOR REMOVAL OF COOLER. USE COMMON SUPPORTS AND BOTTOM OF PIPE ELEVATIONS FOR COMPRESSOR INLET AND OUTLET PIPING.
4. PIPING AND TUBING INSTALLATION, FABRICATION, WELDING INSPECTION, AND TESTING TO BE IN ACCORDANCE WITH ASME B31.3, NORMAL FLUID SERVICE.
5. CONTRACTOR TO FIELD VERIFY DIMENSIONS AND INTERFACE POINTS
6. ALL WELDS INDICATED AT "FFW" TO HAVE 6" ADDED TO CUT LENGTH.
7. CONTRACTOR TO ERECT ALL SPOOL PIECES PRIOR TO ADJUSTING "FFW"
8. CONTRACTOR IS RESPONSIBLE FOR PROVIDING CONNECTIONS, MATERIALS, AND RELIEF DEVICES NECESSARY TO PERFORM LEAK TEST.
9. PNEUMATIC TESTING REQUIRES SPECIAL CONSIDERATIONS. CONSULT ENGINEERING FOR RECOMMENDATIONS.
10. MATERIAL SUBSTITUTIONS BY CONTRACTOR ALLOWED ONLY IF PROVIDED IN WRITING BY ENGINEERING.

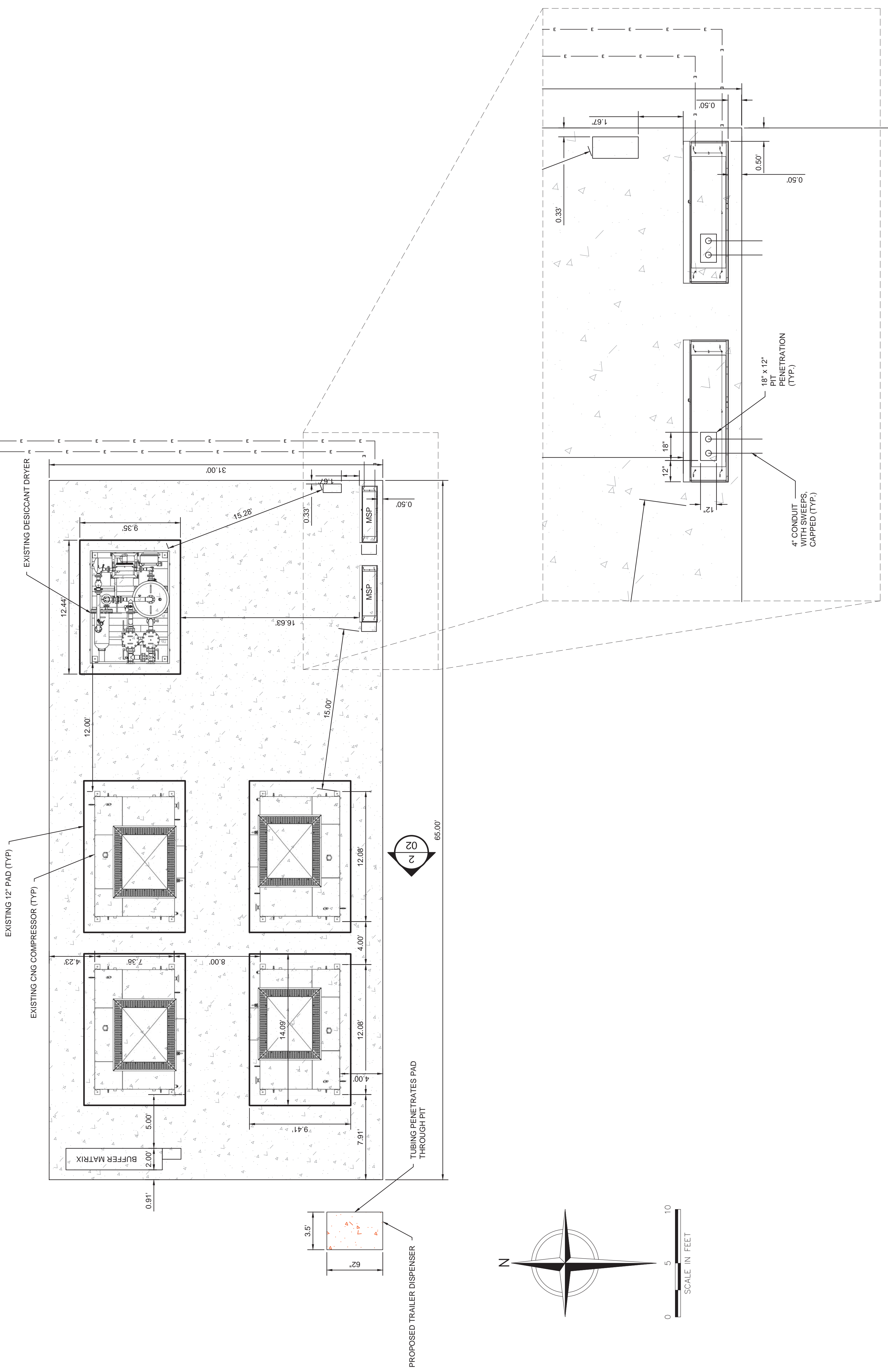

REV.	DATE	DESCRIPTION	DES. BY	CHECK. BY	APP. BY
1	10/21/2020		BB	BB	MUT

DATE OF ISSUE: 10/21/2020
 DRAWN BY: SFC/RME
 DESIGNED BY: BB
 CHECKED BY: BB/DB
 APPROVED BY: MUT



COUNTY OF DANE, DEPT. OF PUBLIC WORKS
 RODEFELD LANDFILL
 DANE COUNTY, WISCONSIN
**DANE COUNTY FUELING FACILITY EXPANSION
 SITE PLAN**

SHEET NO. **C-2**
 PROJECT NO. 4201306

ISSUED FOR BID

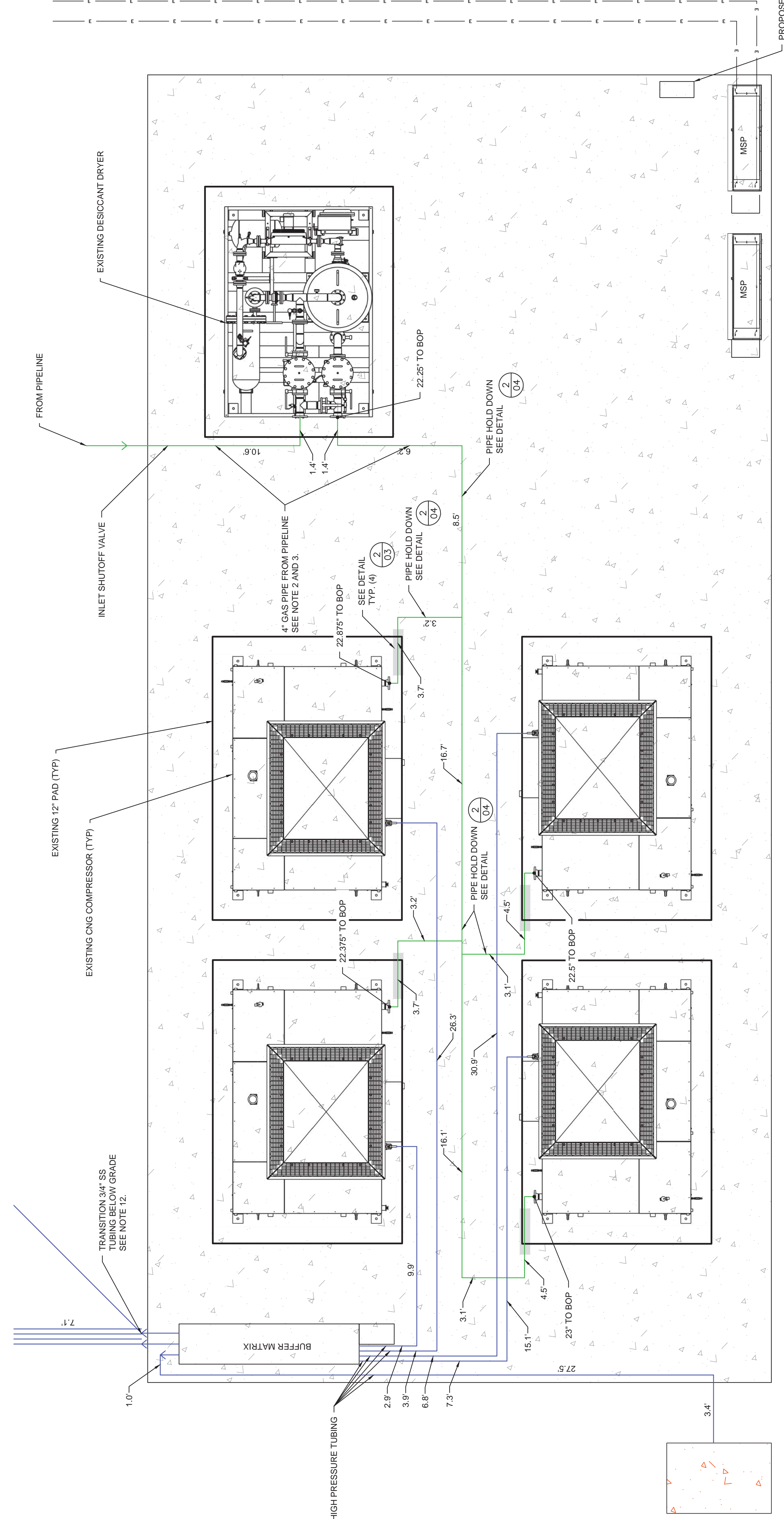

LEGEND

	EXISTING CANOPY OR BUILDING
	EXISTING CONCRETE PAD OR PAVEMENT
	EXISTING ELECTRICAL CONDUIT
	PROPOSED 4" GAS PIPE FROM PIPELINE
	PROPOSED HIGH PRESSURE TUBING
	PROPOSED CONCRETE SLAB
	PROPOSED ELECTRICAL CONDUIT

- NOTES:**
- EXISTING CANOPY, CONCRETE AREAS, ELECTRICAL CONDUIT LINES ARE FROM A CAD FILE TITLED "Dane County Public Works_A-102 - Site Plan - Phase 1_112019.DWG" SUPPLIED BY DANE COUNTY.
 - SLEEPER SUPPORTS WITH 10" - 14" SPACING, 1-RD WITH UBOLT HOLD DOWNS PER TYPICAL DETAIL MPS-022C.
 - MAINTAIN A MINIMUM 48" OF CLEARANCE FROM THE COMPRESSOR BUILDING OUTSIDE WALL TO THE NEAREST OBSTRUCTION INCLUDING PIPING AND ELECTRICAL RACEWAY. CONSIDER EQUIPMENT ACCESS NEEDED FOR REMOVAL OF COOLER. USE COMMON SUPPORTS AND BOTTOM OF PIPE ELEVATIONS FOR COMPRESSOR INLET AND OUTLET PIPING.
 - PIPING AND TUBING INSTALLATION, FABRICATION, WELDING INSPECTION, AND TESTING TO BE IN ACCORDANCE WITH ASME B31.3, NORMAL FLUID SERVICE.
 - CONTRACTOR TO FIELD VERIFY DIMENSIONS AND INTERFACE POINTS
 - ALL WELDS INDICATED AT "FFW" TO HAVE 6" ADDED TO CUT LENGTH.
 - CONTRACTOR TO ERECT ALL SPOOL PIECES PRIOR TO ADJUSTING "FFW"
 - CONTRACTOR IS RESPONSIBLE FOR PROVIDING CONNECTIONS, MATERIALS, AND RELIEF DEVICES NECESSARY TO PERFORM LEAK TEST.
 - PNEUMATIC TESTING REQUIRES SPECIAL CONSIDERATIONS. CONSULT ENGINEERING FOR RECOMMENDATIONS.
 - MATERIAL SUBSTITUTIONS BY CONTRACTOR ALLOWED ONLY IF PROVIDED IN WRITING BY ENGINEERING.
 - 1000 FEET OF SS HIGH PRESSURE TUBING SWAGelok SPEC: 3/4", WALL THICKNESS 0.108, ASTM A269 SEAMLESS 316/316L, AND 1210 SERIES FITTINGS.
 - RUN EACH BURIED 3/4" SS HIGH PRESSURE TUBING IN 2" SCHEDULE 40 PVC CHASE 24" BELOW EXISTING SURFACE. BRING 2" SCHEDULE 40 PVC ABOVE GRADE 12" TO 18" AND UTILIZE LONG RADIUS 45° ELBOWS.
 - 325 FEET OF SCHEDULE 40 PVC CHASE WILL BE NECESSARY FOR THE UNDERGROUND 3/4" SS HIGH PRESSURE TUBING.

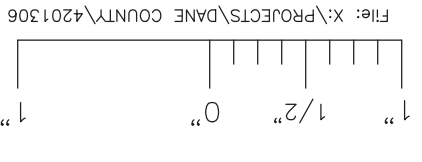
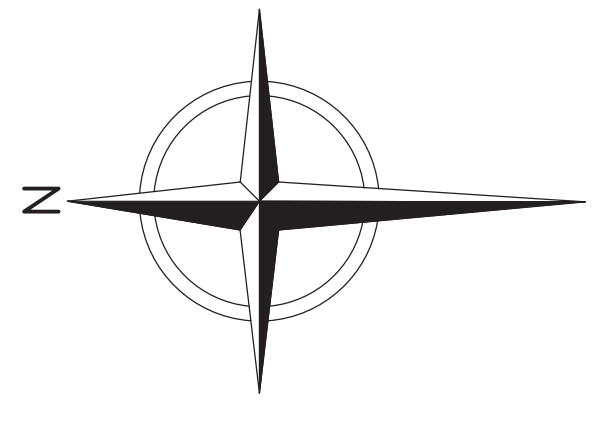

ISSUED FOR BID

SHEET NO. **M-1**
PROJECT NO. 4201306

COUNTY OF DANE, DEPT. OF PUBLIC WORKS
RODEFELD LANDFILL
DANE COUNTY, WISCONSIN

**DANE COUNTY FUELING FACILITY EXPANSION
MECHANICAL PIPING LAYOUT**



REV.	DATE	DESCRIPTION	CHK BY	DES BY	APP BY

DATE OF ISSUE: 10/21/2020
DRAWN BY: SFC/RWF
DESIGNED BY: BB/DB
CHECKED BY: BB/DB
APPROVED BY: MUT

DMV BY: DES BY: CHK BY: APP BY:
BB/DB
MUT

The design is intended to be used as a guide only. It is not intended to be used as a final design. The user is responsible for verifying all dimensions and conditions before construction. Tetra Tech, Inc. is not responsible for any errors or omissions in this drawing. © 2020 Tetra Tech, Inc. All rights reserved.

LEGEND

-  EXISTING CANOPY OR BUILDING
-  EXISTING CONCRETE PAD OR PAVEMENT
-  EXISTING ELECTRICAL CONDUIT
-  PROPOSED 4" GAS PIPE FROM PIPELINE
-  PROPOSED HIGH PRESSURE TUBING
-  PROPOSED CONCRETE SLAB
-  PROPOSED ELECTRICAL CONDUIT

NOTES:

1. EXISTING CANOPY, CONCRETE AREAS, ELECTRICAL CONDUIT LINES ARE FROM A CAD FILE TITLED "Dane County Public Works_A-102 - Site Plan - Phase 1_112019.DWG" SUPPLIED BY DANE COUNTY.
2. SLEEPER SUPPORTS WITH 10' - 14' SPACING, 1-RD WITH UBOLT HOLD DOWNS PER TYPICAL DETAIL MPS-022C.
3. MAINTAIN A MINIMUM 48" OF CLEARANCE FROM THE COMPRESSOR BUILDING OUTSIDE WALL TO THE NEAREST OBSTRUCTION INCLUDING PIPING AND ELECTRICAL RACEWAY. CONSIDER EQUIPMENT ACCESS NEEDED FOR REMOVAL OF COOLER. USE COMMON SUPPORTS AND BOTTOM OF PIPE ELEVATIONS FOR COMPRESSOR INLET AND OUTLET PIPING.
4. PIPING AND TUBING INSTALLATION, FABRICATION, WELDING INSPECTION, AND TESTING TO BE IN ACCORDANCE WITH ASME B31.3, NORMAL FLUID SERVICE.
5. CONTRACTOR TO FIELD VERIFY DIMENSIONS AND INTERFACE POINTS
6. ALL WELDS INDICATED AT "FFW" TO HAVE 6" ADDED TO CUT LENGTH.
7. CONTRACTOR TO ERECT ALL SPOOL PIECES PRIOR TO ADJUSTING "FFW"
8. CONTRACTOR IS RESPONSIBLE FOR PROVIDING CONNECTIONS, MATERIALS, AND RELIEF DEVICES NECESSARY TO PERFORM LEAK TEST.
9. PNEUMATIC TESTING REQUIRES SPECIAL CONSIDERATIONS. CONSULT ENGINEERING FOR RECOMMENDATIONS.
10. MATERIAL SUBSTITUTIONS BY CONTRACTOR ALLOWED ONLY IF PROVIDED IN WRITING BY ENGINEER.
11. 1000 FEET OF SS HIGH PRESSURE TUBING SIWAGelok SPEC: 3/4" WALL THICKNESS 0.108, ASTM A269 SEAMLESS 316/316L, AND 1210 SERIES FITTINGS.
12. RUN EACH BURIED 3/4" SS HIGH PRESSURE TUBING IN 2" SCHEDULE 40 PVC CHASE 24" BELOW EXISTING SURFACE BRING 2" SCHEDULE 40 PVC ABOVE GRADE 12" TO 18" AND UTILIZE LONG RADIUS 45° ELBOWS.
13. 325 FEET OF SCHEDULE 40 PVC CHASE WILL BE NECESSARY FOR THE UNDERGROUND 3/4" SS HIGH PRESSURE TUBING.

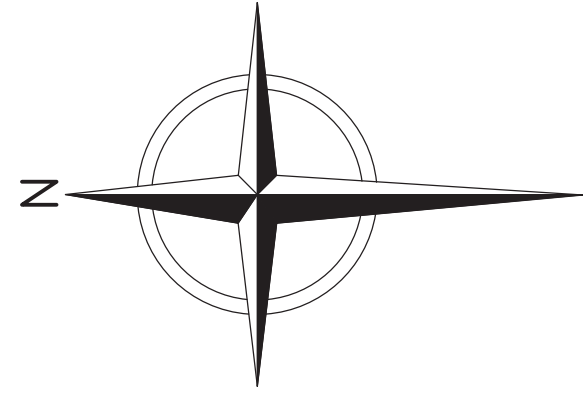

0 10 20
SCALE IN FEET

ISSUED FOR BID

SHEET NO.
M-2
PROJECT NO.
4201306

COUNTY OF DANE, DEPT. OF PUBLIC WORKS
RODEFELD LANDFILL
DANE COUNTY, WISCONSIN
**DANE COUNTY FUELING FACILITY EXPANSION
HIGH PRESSURE TUBING LAYOUT**

TETRA TECH
TETRA TECH logo with tagline "PROFESSIONAL ENGINEERING, ARCHITECTURE & INTERIORS" and "LICENSED PROFESSIONAL ENGINEERS AND ARCHITECTS" below it.

REV.	DATE	DESCRIPTION	CHK BY	APP BY

DATE OF ISSUE: 10/21/2020
DRAWN BY: SFC/RME
DESIGNED BY: BB/DB
CHECKED BY: BB/DB
APPROVED BY: MUT

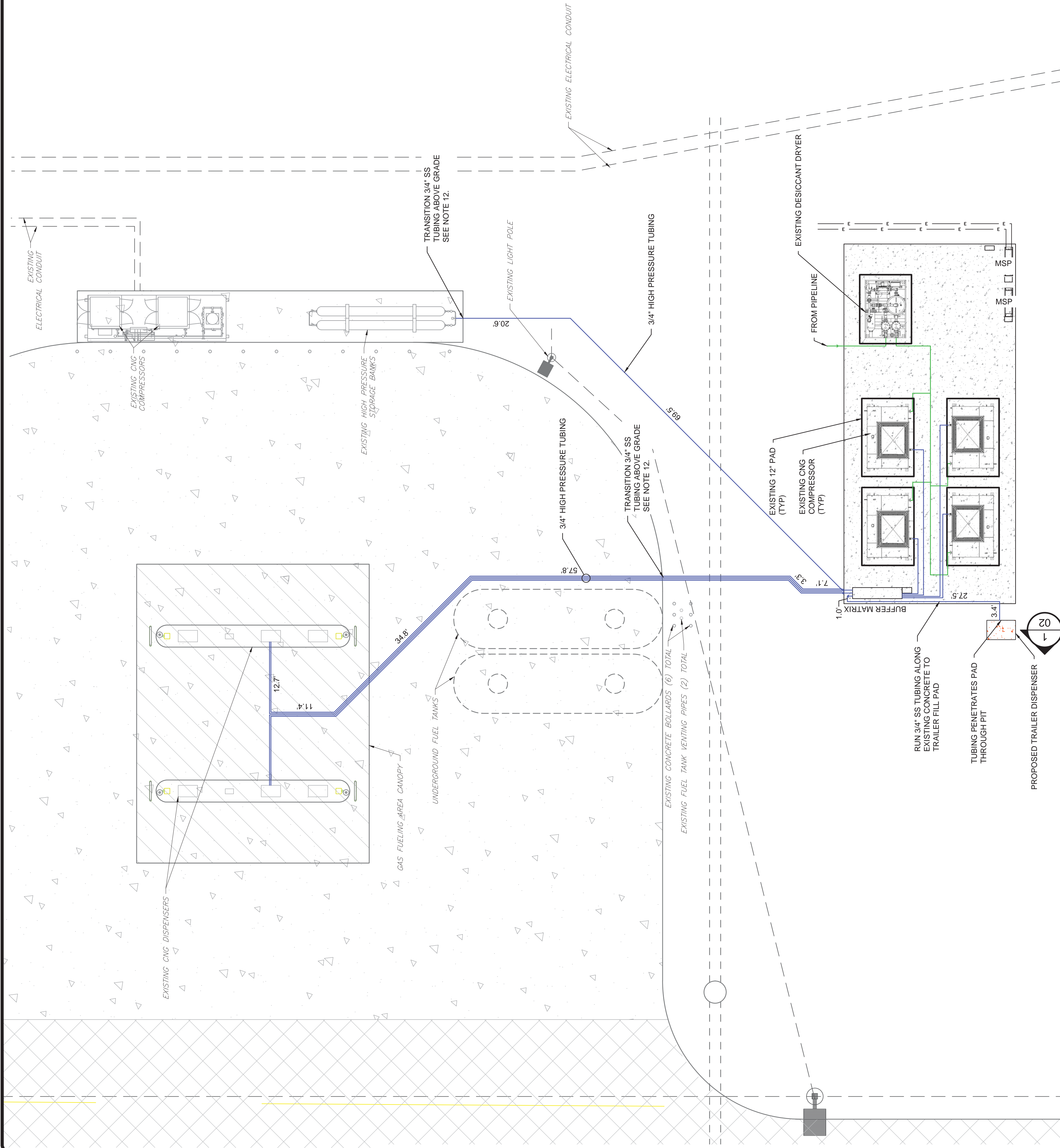

PROPOSED TRAILER DISPENSER
TUBING PENETRATES PAD THROUGH PIT
RUN 3/4" SS TUBING ALONG EXISTING CONCRETE TO TRAILER FILL PAD

BILL OF MATERIALS

ID	QTY	ND	SCH/CLASS	DESCRIPTION
1	4'	2"		PIPE, SEAMLESS, BEVELED END (BE), ASME B36.10, ASTM A106 Gr B SMLS, Sch 40
2	12'	3"		PIPE, SEAMLESS, BEVELED END (BE), ASME B36.10, ASTM A106 Gr B SMLS, Sch 40
3	80'	4"		PIPE, SEAMLESS, BEVELED END (BE), ASME B36.10, ASTM A106 Gr B SMLS, Sch 40
4	4	2"		ANGI SUPPLIED REGULATOR 9" FLANGE TO FLANGE
5	4	2"		90° ELL LONG RADIUS, PIPE, SEAMLESS, BEVELED END (BE), ASME B36.10, ASTM A234 WPB SMLS, Sch 40
6	8	3"		90° ELL LONG RADIUS, PIPE, SEAMLESS, BEVELED END (BE), ASME B36.10, ASTM A234 WPB SMLS, Sch 40
7	4	3"x2"		REDUCER (ECC), BW, ASME B16.9, ASTM A234 Gr WPB SMLS, Sch 40
8	1	4"	150	FLANGE BLIND, 150 LB. RF, ASME B16.5, ASTM A105
9	5	4"		90° ELL LONG RADIUS, PIPE, SEAMLESS, BEVELED END (BE), ASME B36.10, ASTM A234 WPB SMLS, Sch 40
10	4	4"x2"		REDUCING TEE, BW, ASME B16.9, ASTM A234 GR WPB, SCH 40
11	8	2"	150	FLANGE WN, 150 LB, RF, ASME B16.5, ASTM A105
12	16	3"	150	FLANGE WN, 150 LB, RF, ASME B16.5, ASTM A105
13	5	4"	150	FLANGE WN, 150 LB, RF, ASME B16.5, ASTM A105
14	4	2"	150	Boil Valve, 150 LB, A216-WCB, FLOATING-FULL PORT, ASME B16.34, CS+ENP BALL, NYLON SEAT, LEVER OPERATOR, FIRE SAFE.
15	1	4"	150	INLET UTILITY SHUTOFF VALVE, FAIL CLOSE, "PER SPEC"
16	29	4"-5; 3"-16; 2"-8		GASKET, RF, SPIRAL WOUND, 1/8" THICK, 304SS WINDINGS W/ GRAPHITE FILLER, SS INNER RING, CS OUTER RING, LOW SEATING STRESS, FLEXITALIC LSI EQUAL, ASME B18.2.1/B18.2.2
17	29	4"-5; 3"-16; 2"-8		STUD BOLT SET, ASTM A193-B7 STUDS AND ASTM A194-2H HEX NUTS, ASME B18.2.1/B18.2.2
18	4	1/2"	3000# CWP	Threaded Ball Valve, CS, A216-WCB, FLOATING, FULL PORT, CS+ENP BALL, NYLON SEAT, LEVER OPERATOR, FIRE SAFE, ASME B16.34
19	4	1/2"	CL 3000	THREADOLET, ASTM A105, MSS SP-97
20	4	1/2"	MATCH PIPE	NIPPLE, SMLS, ASTM A106-B, ASTM A733, Sch 80

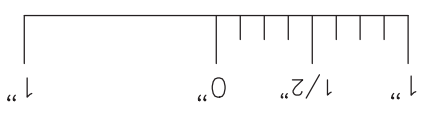
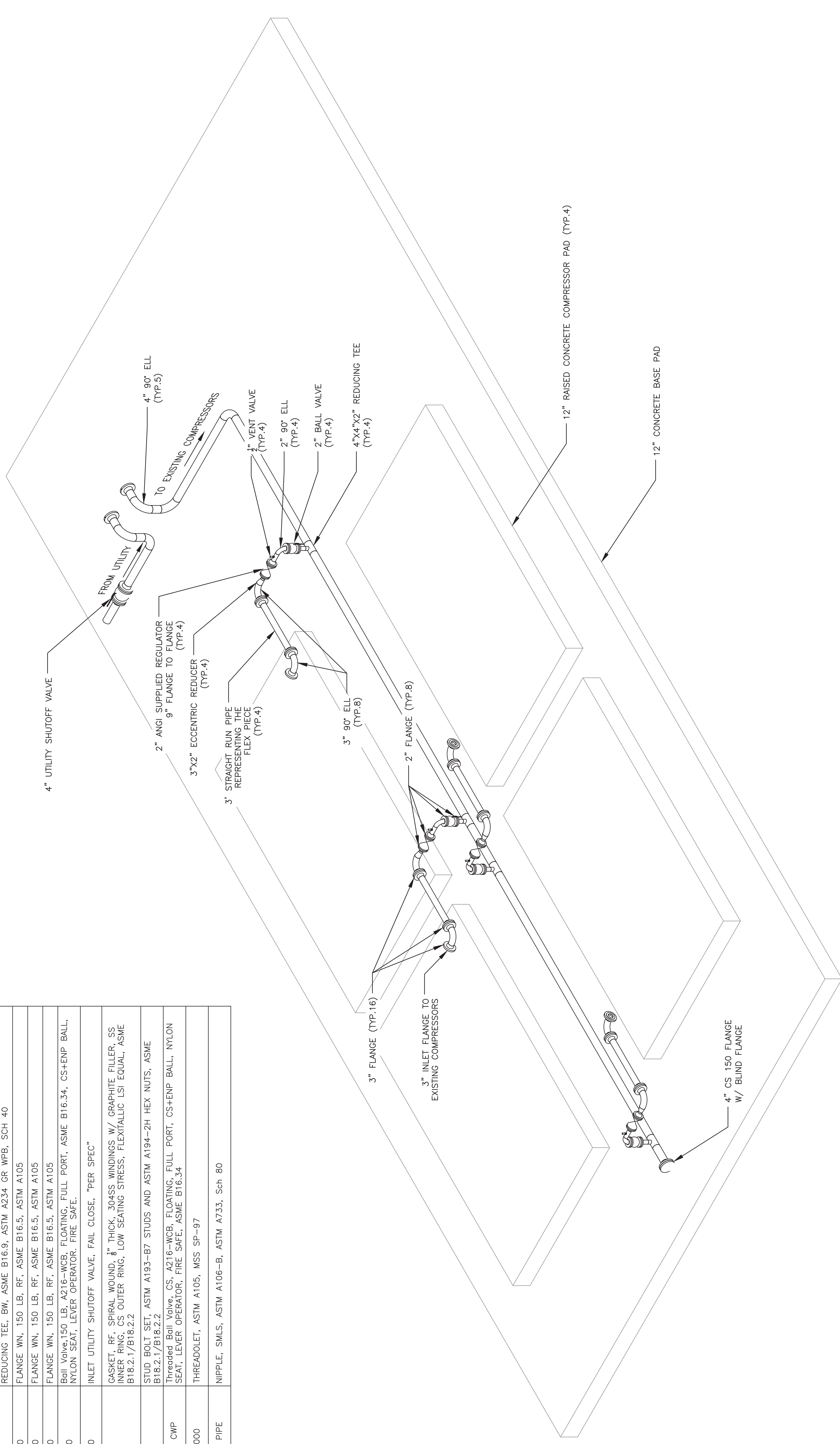

ISSUED FOR BID

SHEET NO. **M-3**
PROJECT NO. 4201306

COUNTY OF DANE, DEPT. OF PUBLIC WORKS
RODEFELD LANDFILL
DANE COUNTY, WISCONSIN
**DANE COUNTY FUELING FACILITY EXPANSION
UTILITY MECHANICAL PIPING LAYOUT**



REV	DATE	DESCRIPTION	DWN BY	DES BY	CHK BY	APP BY
	10/21/2020		RWIE	BB/DB		
			BB/DB			

This drawing is the property of Tetra Tech, Inc. and is intended for use only for the project and location specified. It is not to be used for any other project or location without the written consent of Tetra Tech, Inc. All rights reserved. Tetra Tech, Inc. is a registered professional engineering firm in the State of Wisconsin.

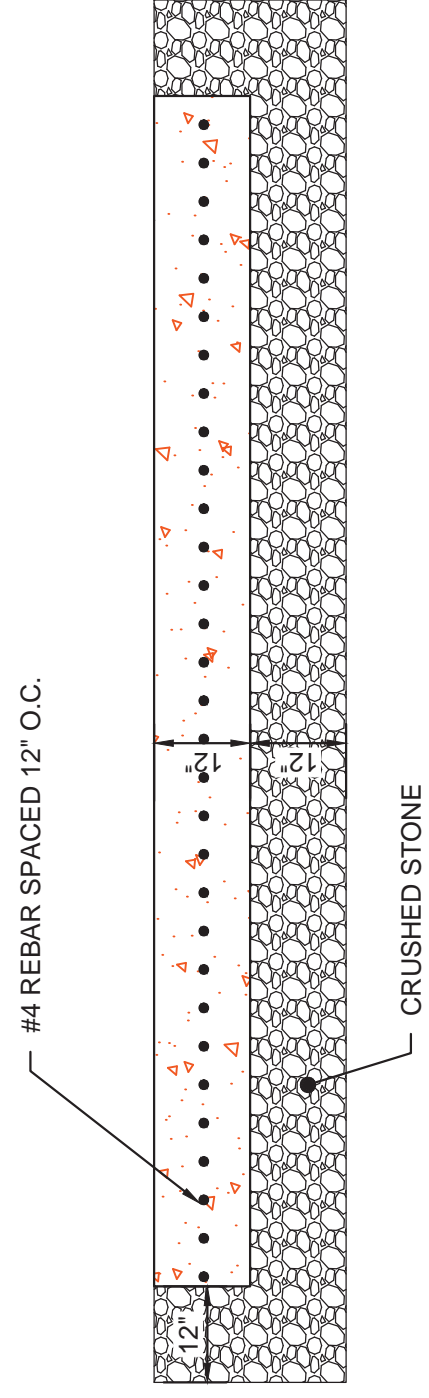

TRAILER DISPENSER CONCRETE SLAB

SECTION 2 01
SCALE: NOT TO SCALE

NOTES:

- EXISTING RAISED CONCRETE PADS ARE 1" WIDER THAN EQUIPMENT FOOTINGS.

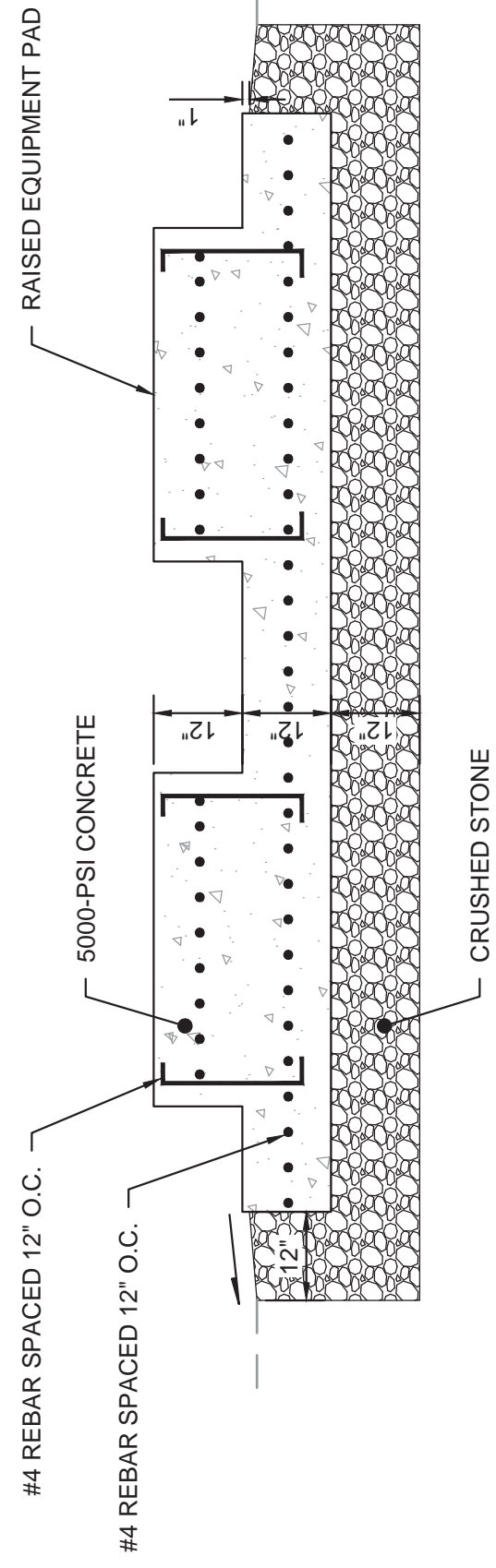

CONCRETE SLAB WITH RAISED EQUIPMENT PADS

SECTION 2 02
SCALE: NOT TO SCALE

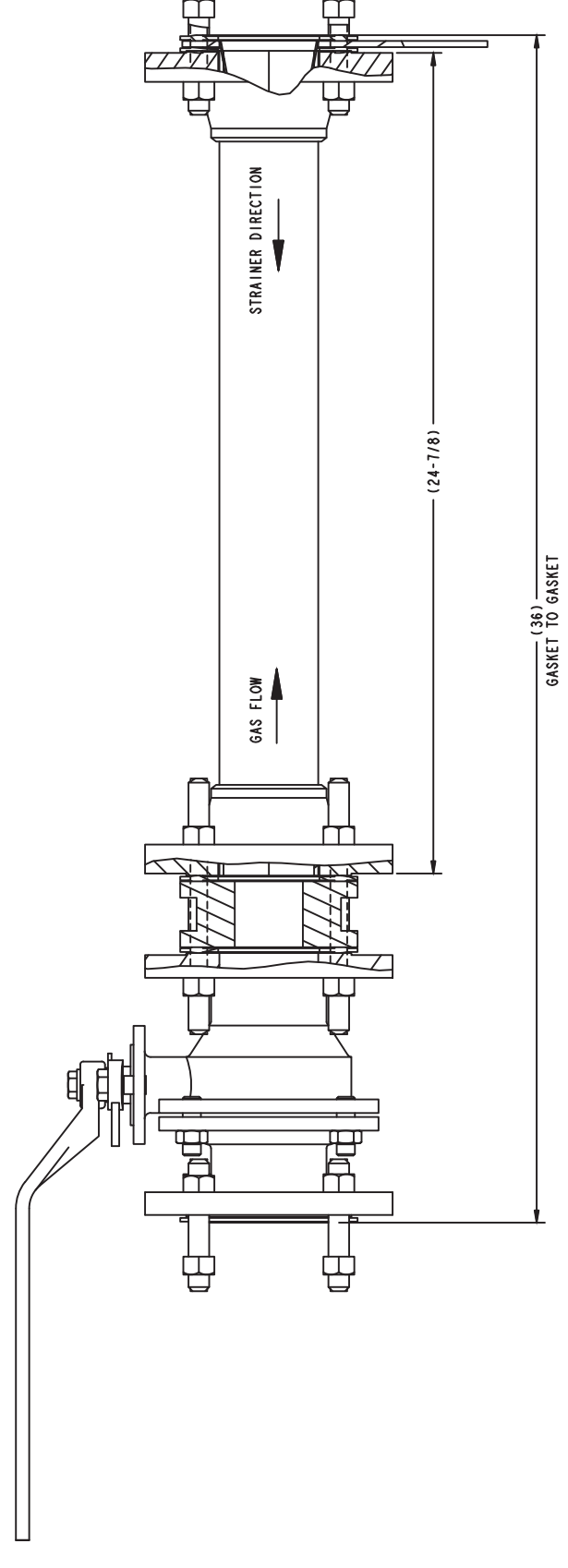

HOSE FLEX PIECE

DETAIL 2 03
SCALE: NOT TO SCALE

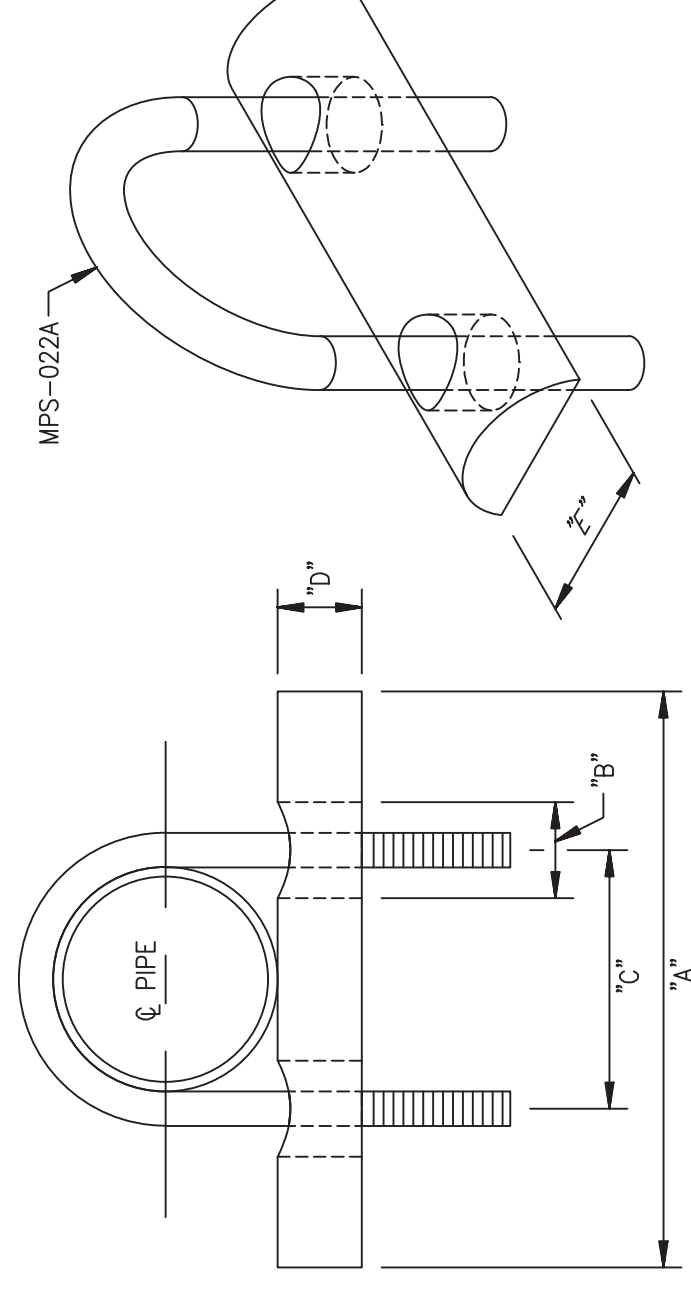

4" PIPE HOLD DOWN MPS-022C

DETAIL 2 04
SCALE: NOT TO SCALE

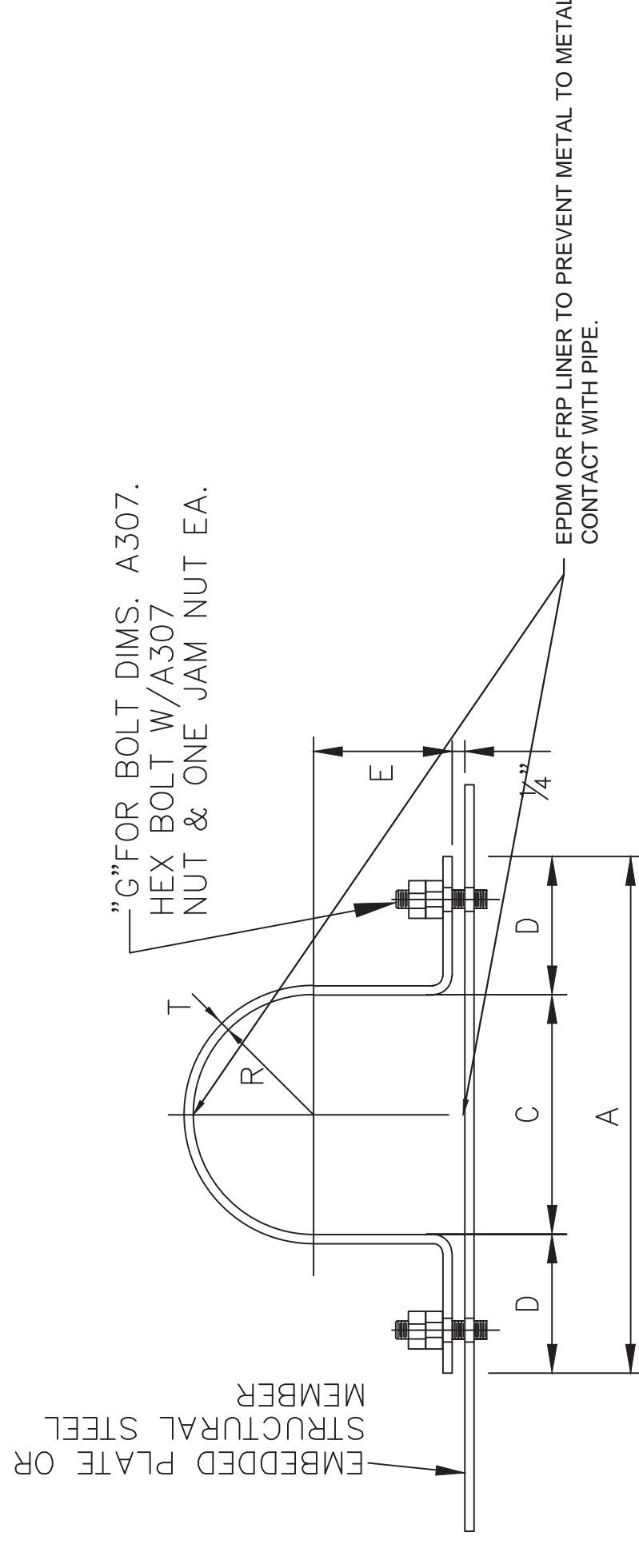

4" PIPE HOLD DOWN MPS-020D

DETAIL 2 04
SCALE: NOT TO SCALE

REV.	DATE	DESCRIPTION	DWN. BY	DES. BY	CHK. BY	APP. BY
	10/21/2020			SJC/RM/E	BB/DB	
				BB/DB		
					MUT	

This drawing is intended for informational purposes only. It is not intended to be used for construction or to replace the original design. The user assumes all responsibility for the use of this drawing. The user is advised to verify the dimensions and details of the drawing before use. The user is advised to consult with the design professional for any questions or clarifications. The design professional is not responsible for the use of this drawing for any purpose other than that for which it was intended.

ISSUED FOR BID

SHEET NO. **02**
PROJECT NO. 4201306

COUNTY OF DANE, DEPT. OF PUBLIC WORKS
RODEFELD LANDFILL
DANE COUNTY, WISCONSIN
DANE COUNTY FUELING FACILITY EXPANSION
DETAILS



DRAWN BY: SJC/RM/E
 DESIGNED BY: BB/DB
 CHECKED BY: BB/DB
 APPROVED BY: MUT