



RFB NO. 320010

CONSTRUCTION DOCUMENTS PROJECT MANUAL

DANE COUNTY DEPARTMENT OF PUBLIC WORKS,
HIGHWAY AND TRANSPORTATION

PUBLIC WORKS ENGINEERING DIVISION
1919 ALLIANT ENERGY CENTER WAY
MADISON, WISCONSIN 53713

REQUEST FOR BIDS NO. 320010 PHOTOVOLTAIC SYSTEMS LUSSIER FAMILY HERITAGE CENTER & LAKE FARM PARK 3101 LAKE FARM ROAD MADISON, WISCONSIN

Due Date / Time: **TUESDAY, JUNE 2, 2020 / 2:00 P.M.**

Location: **PUBLIC WORKS OFFICE**

Performance / Payment Bond: **100% OF CONTRACT AMOUNT**

Bid Deposit: **5% OF BID AMOUNT**

FOR INFORMATION ON THIS REQUEST FOR BIDS, PLEASE CONTACT:

RYAN SHORE, PROJECT MANAGER
TELEPHONE NO.: 608/445-0109
FAX NO.: 608/267-1533
E-MAIL: SHORE@COUNTYOFDANE.COM

SECTION 00 01 10

TABLE OF CONTENTS

DIVISION 00 - PROCUREMENT AND CONTRACTING REQUIREMENTS

- 00 01 01 - Project Manual Cover Page
- 00 01 10 - Table of Contents
- 00 11 16 - Invitation to Bid
- 00 21 13 - Instructions to Bidders
- 00 41 13 - Bid Form
- 00 52 96 - Sample Public Works Construction Contract
- 00 61 12 - Sample Bid Bond
- 00 61 13.13 - Sample Performance Bond
- 00 61 13.16 - Sample Payment Bond
- 00 72 13 - General Conditions of Contract
- 00 73 00 - Supplementary Conditions
- 00 73 07 - Best Value Contracting Application
- 00 73 11 - Fair Labor Practices Certification

DIVISION 01 - GENERAL REQUIREMENTS

- 01 00 00 - General Requirements
- 01 74 19 - Construction Waste Management, Disposal & Recycling

DIVISION 03 - CONCRETE

- 03 20 00 - Concrete Reinforcing
- 03 30 00 - Cast-In-Place Concrete

DIVISION 05 - METALS

- 05 12 00 - Structural Steel Framing

DIVISION 26 - ELECTRICAL

- 26 05 00 - Common Work Results for Electrical
- 26 05 04 - Cleaning, Inspection and Testing for Electrical Equipment
- 26 05 19 - Low Voltage Electrical Power Conductors and Cable
- 26 05 26 - Grounding and Bonding for Electrical Systems
- 26 05 29 - Hangers and Supports for Electrical Systems
- 26 05 33 - Raceway and Boxes for Electrical Systems
- 26 24 16 - Panelboards
- 26 27 28 - Disconnect Switches
- 26 27 43 - Electric Vehicle Service Equipment-AC Level 2
- 26 31 00 - Photovoltaic Collectors

DIVISION 31 - EARTHWORK

- 31 20 00 - Earthmoving

DIVISION 32 - EXTERIOR IMPROVEMENTS

- 32 12 16 - Asphalt Paving
- 32 13 13 - Concrete Paving

DRAWINGS

- Plot drawings on 24" x 36" (ARCH D) paper for correct scale or size.
- Sheet T100 - Title Page
 - Sheet C001 - Overall Civil Site Plan
 - Sheet C101 - Lussier Family Heritage Center Civil Site Plan
 - Sheet C102 - Lake Farm Campground Civil Site Plan

Sheet C201 - Heritage Center Civil Site Plan
Sheet C202 - Lake Farm Campground Civil Site Plan
Sheet S000 – Structural Index, Legends and Specifications
Sheet S101 – Foundation and Framing Plan
Sheet S301 - Details
Sheet E001 – Schedules, Abbreviations and Legend
Sheet E101 – Lussier Family Heritage Center Electrical Site Plan
Sheet E102 - Lake Farm Campground Electrical Site Plan
Sheet E201 - Heritage Center Electrical Site Plan
Sheet E202 - Lake Farm Campground Electrical Site Plan
Sheet E301 – Shelter Elevations
Sheet E401 – Lussier Family Heritage Center Electrical Online Diagram
Sheet E402 – Lake Farm Campground Electrical Online Diagram

END OF SECTION

SECTION 01 11 16

INVITATION TO BID

LEGAL NOTICE

Dane County Dept. of Public Works, Hwy & Transp., 1919 Alliant Energy Center Way, Madison, WI 53713, will receive sealed Bids until:

2:00 P.M., TUESDAY, JUNE 2, 2020

RFB NO. 320010

PHOTOVOLTAIC SYSTEMS

LUSSIER FAMILY HERITAGE CENTER & LAKE FARM PARK

3101 LAKE FARM ROAD MADISON, WISCONSIN

Dane County is inviting Bids for construction services to provide two park shelters, photovoltaic systems and associated infrastructure. Only firms with capabilities, experience & expertise with similar projects should obtain this Request for Bids (RFB) document & submit Bids.

RFB document may be obtained after **2:00 p.m. on April 21, 2020** by downloading it from bids-pwht.countyofdane.com. Please call Ryan Shore, Project Mgr., at 608/445-0109, or our office at 608/266-4018, for any questions or additional information.

All Bidders must be qualified as, or apply to be a Best Value Contractor before Bid Due Date. Complete Pre-qualification Application for Contractors at pwht.countyofdane.com/bvc_application.aspx or obtain one by calling 608/267-0119.

A pre-bid site tour will be held Tuesday, May 12, 2020 at 1 p.m. at Lussier Family Heritage Center, starting in the parking lot. Bidders are strongly encouraged to attend this tour.

**PUBLISH: APRIL 23 & APRIL 28, 2020 - WISCONSIN STATE JOURNAL
 APRIL 22 & APRIL 29, 2020 - THE DAILY REPORTER**

END OF SECTION

SECTION 00 21 13

INSTRUCTIONS TO BIDDERS

TABLE OF CONTENTS

1. GENERAL	1
2. DRAWINGS AND SPECIFICATIONS	2
3. INTERPRETATION	2
4. QUALIFICATIONS OF BIDDER (CONTRACTOR AND SUBCONTRACTOR)	2
5. BID GUARANTEE	3
6. WITHDRAWAL OF BIDS	3
7. CONTRACT FORM	3
8. CONTRACT INTERESTS BY COUNTY PUBLIC OFFICIALS	4
9. EMERGING SMALL BUSINESS PROVISIONS	4
10. METHOD OF AWARD - RESERVATIONS	6
11. SECURITY FOR PERFORMANCE AND PAYMENTS	6
12. TAXES	6
13. SUBMISSION OF BIDS	7
14. SUBCONTRACTOR LISTING	7
15. ALTERNATE BIDS	8
16. INFORMATIONAL BIDS	8
17. UNIT PRICES	8
18. COMMENCEMENT AND COMPLETION	8
19. WORK BY OWNER	8
20. SPECIAL HAZARDS COVERAGE	8
FORM A	9
FORM B	10
FORM C	11
FORM D	12

1. GENERAL

- A. Before submitting Bid, bidder shall thoroughly examine all Construction Documents. Successful Bidder shall be required to provide all the Work that is shown on Drawings, set forth in Specifications, or reasonably implied as necessary to complete Contract for this project.
- B. Bidder shall visit site to become acquainted with adjacent areas, means of approach to site, conditions of actual site and facilities for delivering, storing, placing, and handling of materials and equipment.
- C. Pre-bid meeting is scheduled on at 1 p.m., Tuesday, May 12, 2020 at Lussier Heritage Center, 3101 Lake Farm Rd., Madison, WI starting in the parking lot. Attendance by all bidders is optional, however bidders and subcontractors are strongly encouraged to attend.
- D. Failure to visit site or failure to examine any and all Construction Documents will in no way relieve successful Bidder from necessity of furnishing any necessary materials or equipment, or performing any work, that may be required to complete the Work in accordance with Drawings and Specifications. Neglect of above requirements will not be accepted as reason for delay in the Work or additional compensation.

2. DRAWINGS AND SPECIFICATIONS

- A. Drawings and Specifications that form part of this Contract, as stated in Article 1 of General Conditions of Contract, are enumerated in Document Index of these Construction Documents.
- B. Complete sets of Drawings and Specifications for all trades will be available to all Bidders, irrespective of category of work to be bid on, in order that all Bidders may be familiar with work of other trades as they affect their bid.

3. INTERPRETATION

- A. No verbal explanation or instructions will be given in regard to meaning of Drawings or Specifications before Bid Due Date. Bidders shall bring inadequacies, omissions or conflicts to Owner or Architect / Engineer's attention at least ten (10) calendar days before Bid Due Date. Prompt clarification will be available to all bidders by Addendum.
- B. Failure to so request clarification or interpretation of Drawings and Specifications will not relieve successful Bidder of responsibility. Signing of Contract will be considered as implicitly denoting that Contractor has thorough understanding of scope of the Work and comprehension of Construction Documents.
- C. Owner or Engineer will not be responsible for verbal instructions.

4. QUALIFICATIONS OF BIDDER (CONTRACTOR AND SUBCONTRACTOR)

- A. Before award of Contract can be approved, Owner shall be satisfied that Bidder involved meets following requirements:
 - 1. Has completed at least one (1) project of at least fifty percent (50%) of size or value of Division of work being bid and type of work completed is similar to that being bid. If greater magnitude of experience is deemed necessary, other than size or value of work, such requirements will be described in appropriate section of Specifications.
 - 2. Maintains permanent place of business.
 - 3. Can be bonded for terms of proposed Contract.
 - 4. Meets all applicable Best Value Contractor requirements.
 - 5. Has record of satisfactorily completing past projects and supplies list of no more than three (3) most recent, similar projects, with architect or engineer's and owner's names, addresses and telephone numbers for each project. Submit to Public Works, Project Manager with Bid. Criteria which will be considered in determining satisfactory completion of projects by bidder will include:
 - a. Completed contracts in accordance with drawings and specifications.
 - b. Diligently pursued execution of work and completed contracts according to established time schedule unless Owner grants extensions.
 - c. Fulfilled guarantee requirements of construction documents.
 - d. Is not presently on ineligible list maintained by County's Department of Administration for noncompliance with equal employment opportunities and affirmative action requirements.
 - e. Authorized to conduct business in Wisconsin. By submitting Bid, bidder warrants that it has: complied with all necessary requirements to do business in State of

Wisconsin; that persons executing contract on its behalf are authorized to do so; and, if corporation, that name and address of bidder's registered agent are as set forth in Contract. Bidder shall notify Owner immediately, in writing, of any change in its registered agent, their address, and bidder's legal status. For partnership, term "registered agent" shall mean general partner.

- B. County's Public Works Project Manager will make such investigations as are deemed necessary to determine ability of bidder to perform the Work, and bidder shall furnish to County's Public Works Project Manager or designee all such information and data for this purpose as County's Public Works Project Manager may request. Owner reserves right to reject Bid if evidence submitted by, or investigation of, bidder fails to satisfy Owner that bidder is responsible and qualified to carry out obligations of Contract and to complete the Work contemplated therein.

5. BID GUARANTEE

- A. Bank certified check, cashier's check or Bid Bond, payable to County in amount not less than five percent (5%) of maximum bid, shall accompany each Bid as guarantee that if Bid is accepted, Bidder will execute and return proposed Contract and Performance and Payment Bonds within ten (10) business days after being notified of acceptance of Bid. Company issuing bonds must be licensed to do business in Wisconsin.
- B. Any bid, which is not accompanied by bid guarantee, will be considered "No Bid" and will not be read at Bid Due Date.
- C. If successful Bidder so delivers Contract, Certificate of Insurance, and Performance and Payment Bonds, check will be returned to Bidder. In case Bidder fails to deliver such Contract, insurance, and bond, amount of bid guarantee will be forfeited to County as liquidated damages.
- D. All checks tendered as bid guarantee, except those of three (3) lowest qualified, responsible bidders, will be returned to their makers within three (3) business days after Bid Due Date. All such retained checks will be returned immediately upon signing of Contract and Performance and Payment Bonds by successful Bidder.

6. WITHDRAWAL OF BIDS

- A. Bids may be withdrawn by written request received from bidder or authorized representative thereof prior to time fixed for Bid Due Date, without prejudice to right of bidder to file new Bid. Withdrawn Bids will be returned unopened. Negligence on part of bidder in preparing their Bid confers no right for withdrawal of Bid after it has been opened.
- B. No Bid may be withdrawn for period of sixty (60) calendar days after Bid Due Date.
- C. If Bid contains error, omission or mistake, bidder may limit liability to amount of bidder's guarantee by giving written Notice of Intent not to execute Contract to Owner within seventy-two (72) hours of Bid Due Date.

7. CONTRACT FORM

- A. Sample copy of contract that successful Bidder will be required to enter into is included in these Construction Documents and bidders are required to familiarize themselves with all conditions contained therein.

8. CONTRACT INTERESTS BY COUNTY PUBLIC OFFICIALS

- A. In accordance with Wisconsin Statute 946.13, county official may not bid for or enter into any contract involving receipts or disbursements of more than \$15,000.00 in a year, in which they have private pecuniary interest, direct or indirect if at same time they are authorized to take official action with respect to making of this Contract. Any contract entered into in violation of this Statute is void and County incurs no liability thereon. This subsection does not affect application and enforcement of Wisconsin Statute 946.13 by state prosecutors in criminal courts of this state.

9. EMERGING SMALL BUSINESS PROVISIONS

- A. **Emerging Small Business Definition.** For purposes of this section, ESB is defined as:
1. Independent business concern that has been in business minimum of one year;
 2. Business located in State of Wisconsin;
 3. Business comprised of less than twenty-five (25) employees;
 4. Business must not have gross sales in excess of three million dollars (\$3,000,000.00) over past three years; and
 5. Business does not have history of failing to complete projects.
- B. **Emerging Small Business (ESB) Involvement.** Bidder shall make good faith effort to award minimum of ten percent (10%) of the Work to ESBs. Bidder shall submit report to Dane County Contract Compliance Specialist within ten (10) business days of Bid Due Date demonstrating such efforts. Good faith efforts means significant contact with ESBs for purposes of soliciting bids from them. Failure to make or demonstrate good faith efforts will be grounds for disqualification.
- C. **Emerging Small Business Report.** Emerging Small Business Enterprise Report is to be submitted by Bidder in separate envelope marked "Emerging Small Business Report". This report is due by 2:00 p.m. following specified ten (10) business days after Bid Due Date. Bidder who fails to submit Emerging Small Business Report shall be deemed not responsive.
- D. **ESB Goal.** Goal of this project is ten percent (10%) ESB participation. ESB utilizations are shown as percentage of total Bid. If Bidder meets or exceeds specified goal, Bidder is only required to submit Form A - Certification, and Form B - Involvement. Goal shall be met if Bidder qualifies as ESB.
- E. **Report Contents.** Following award of Contract, Bidder shall submit copies of executed contracts for all Emerging Small Businesses. Emerging Small Business Report shall consist of these:
1. Form A - Certification;
 2. Form B - Involvement;
 3. Form C - Contacts;
 4. Form D - Certification Statement (if appropriate); and

5. Supportive documentation (i.e., copies of correspondence, telephone logs, copies of advertisements).
- F. **ESB Listing.** Bidders may solicit bids from this ESB listing:
pdf.countyofdane.com/commissions/2013-2015_Targeted_Business_Directory.pdf.
- G. **ESB Certification.** All contractors, subcontractors and suppliers seeking ESB certification must complete and submit Emerging Small Business Report to Dane County Contract Compliance Program.
- H. **Certification Statement.** If ESB firm has not been certified by County as ESB prior to submittal of this Bid, ESB Report cannot be used to fulfill ESB goal for this project unless firm provides "Form D - Certification Statement". Certification statement must be completed and signed by ESB firm.
- I. **Questions.** Questions concerning Emerging Small Business provisions shall be directed to:
- Dane County Contract Compliance Specialist
City-County Building, Room 356
210 Martin Luther King, Jr. Blvd.
Madison, WI 53703
608/266-4192
- J. **Substituting ESBs.** In event of any significant changes in subcontract arrangements or if need arises to substitute ESBs, Bidder shall report such proposed changes to Contract Compliance Specialist to making any official changes and request authorization to substitute ESB firm. Bidder further agrees to make every possible effort to replace ESB firm with another qualified ESB firm.
- K. **Good Faith Efforts.** Good faith efforts can be demonstrated by meeting all of these obligations:
1. Selecting portions of the Work to be performed by ESBs in order to increase likelihood of meeting ESB goal including, where appropriate, breaking down Contract into smaller units to facilitate ESB participation.
 2. Advertising in general circulation, trade associations and women / minority focus media concerning subcontracting opportunities.
 3. Providing written notices to reasonable number of specific ESBs that their interest in Contract was being solicited in sufficient time to allow ESBs to participate effectively.
 4. Following up on initial solicitations of interest by contacting ESBs within five (5) business days prior to Bid Due Date to determine with certainty whether ESB were interested, to allow ESBs to prepare bids.
 5. Providing interested ESB with adequate information about Drawings, Specifications and requirements of Contract.
 6. Using services of available minority, women and small business organizations and other organizations that provide assistance in recruitment of MBEs / WBEs / ESBs.
 7. Negotiating in good faith with interested ESBs, not rejecting ESBs as unqualified without sound reason based on thorough investigation of their capabilities.

8. Submitting required project reports and accompanying documents to County's Contract Compliance Specialist within twenty-four (24) hours after Bid Due Date.

- L. **Appeals Disqualification of Bid.** Bidder who is disqualified may appeal to Public Works & Transportation Committee and Equal Opportunity Commission.

10. METHOD OF AWARD - RESERVATIONS

- A. Following will be basis of award of Contract, providing cost does not exceed amount of funds then estimated by County as available to finance Contract(s):
 1. Lowest dollar amount submitted by qualified responsible bidder on Base Bid for all work comprising project, combined with such additive Owner accepted alternates.
 2. Owner reserves right to reject all bids or any bid, to waive any informality in any bid, and to accept any bid that will best serve interests of County.
 3. Unit Prices and Informational Bids will not be considered in establishing low bidder.

11. SECURITY FOR PERFORMANCE AND PAYMENTS

- A. Simultaneous with delivery of signed Contract, Bidder shall be required to furnish Performance and Payment Bonds as specified in Article 29 of General Conditions of Contract, "Contract Security". Surety Company shall be licensed to do business in Wisconsin. Performance and Payment Bonds must be dated same date or subsequent to date of Contract. Performance and Payment Bonds must emulate information in Sample Performance and Payment Bonds in Construction Documents.
- B. Provide certified copy of power of attorney from Surety Company showing that agent who signs Bond has power of attorney to sign for Surety Company. Secretary or Assistant Secretary of company must sign this certification, not attorney-in-fact. Certification must bear same or later date as Bond. Power of Attorney must emulate model power of attorney information detailed in Sample Performance and Payment Bonds.
- C. If Bidder is partnership or joint venture, State certified list, providing names of individuals constituting partnership or joint venture must be furnished. Contract itself may be signed by one partner of partnership, or one partner of each firm comprising joint venture, but Performance and Payment Bonds must be signed by all partners.
- D. If Bidder is corporation, it is necessary that current certified copy of resolution or other official act of directors of corporation be submitted showing that person who signs Contract is authorized to sign contracts for corporation. It is also necessary that corporate seal be affixed to resolution, contract, and performance and payment bonds. If your corporation has no seal, it is required that above documents include statement or notation to effect that corporation has no seal.

12. TAXES

- A. Wisconsin Statute 77.54 (9m) allows building materials that become part of local unit government facilities to be exempt from sales & use tax. Vendors & materials suppliers may not charge Bidders sales & use tax on these purchases. This does not include highways, streets or roads. Any other Sales, Consumer, Use & other similar taxes or fees required by law shall be included in Bid.

- B. In accordance with Wisconsin Statute 71.80(16)(a), successful nonresident bidder, whether incorporated or not, and not otherwise regularly engaged in business in this state, shall file surety bond with State of Wisconsin Department of Revenue payable to Department of Revenue, to guarantee payment of income taxes, required unemployment compensation contributions, sales and use taxes and income taxes withheld from wages of employees, together with any penalties and interest thereon. Amount of bond shall be three percent (3%) of Contract or subcontract price on all contracts of \$50,000 or more.

13. SUBMISSION OF BIDS

- A. All Bids shall be submitted on standard Bid Form bound herein and only Bids that are made on this Bid Form will be considered. Entire Bid Form and other supporting documents, if any, shall be removed or copied from Construction Documents, filled out, and submitted in manner specified hereinafter. Submit completed Bid Bond with Bid as well.
- B. No bids for any subdivision or any sub-classification of this Work, except as indicated, will be accepted. Any conditional Bid, amendment to Bid Form or appended item thereto, or inclusion of any correspondence, written or printed matter, or details of any nature other than that specifically called for, which would alter any essential provision of Construction Documents, or require consideration of unsolicited material or data in determining award of Contract, will disqualify Bid. Telecommunication alterations to Bid will not be accepted.
- C. Bidders must submit single Bid for all the Work.
- D. Bid amounts shall be inserted in words and in figures in spaces provided on Bid Form; in case of conflict, written word amounts will govern.
- E. Addenda issued after Bid Letting shall become part of Construction Documents. Bidders shall acknowledge receipt of such addenda in appropriate space provided on Bid Form. Bid may be rejected if receipt of any particular addendum applicable to award of Contract has not been acknowledged on Bid Form.
- F. Bids shall be signed, placed in envelope, sealed and delivered before due time to place designated in Invitation to Bid, and identified with project name, bid number, location, category of work being bid upon, Bid Due Date, name and address of bidder.
- G. Bidder shall be responsible for sealed Bid being delivered to place designated for Bid Due Date on or before date and time specified. Bids received after time of closing will be rejected and returned to bidder unopened.
- H. Bid will be considered invalid and will be rejected if bidder has not signed it.
- I. Faxed or emailed Bids will not be accepted.
- J. Bidder's organization shall submit completed with Bid, Fair Labor Practices Certification form, included in these Construction Documents.

14. SUBCONTRACTOR LISTING

- A. Bidders shall be required to submit list of major subcontractors for General Construction, Plumbing, HVAC, and Electrical work proposed for this project to include committed prices for each subcontractor. List shall be placed in separate sealed envelope that must be clearly identified as "Major Subcontractor List", for named project and name of Bidder submitting it.

County must receive envelope no later than date by which successful Bidder is required to submit his or her signed Contract, as established in Construction Documents.

15. ALTERNATE BIDS

A. Not Applicable.

16. INFORMATIONAL BIDS

A. Not Applicable.

17. UNIT PRICES

A. Not Applicable.

18. COMMENCEMENT AND COMPLETION

- A. Successful Bidder shall commence work when schedule and weather permit, but no later than stated in Bid Form. Contractor shall pursue the Work regularly and continuously at reasonable rate to insure completion of the Work within time stated in Bid.
- B. Should it be found impossible to complete the Work on or before time specified for completion, written request may be submitted for extension of time setting forth reasons believed to justify granting of such request. Refer to Article 20 of General Conditions of Contract, titled "Time for Completion"..

19. WORK BY OWNER

- A. This work will be accomplished by Owner or will be let under separate contracts and will not be included under this Contract:
 - 1. Site grading and placement of aggregate base for shelter structures.
 - 2. Furnish & install project signage.

20. SPECIAL HAZARDS COVERAGE

A. Not Applicable.

FORM A

**DANE COUNTY
EMERGING SMALL BUSINESS REPORT - CERTIFICATION**

In accordance with General Conditions of Contract, submit this Emerging Small Business Report within ten (10) days after Bid Due Date.

PROJECT NAME: _____

BID NO.: _____ BID DUE DATE: _____

BIDDER INFORMATION

COMPANY NAME: _____

ADDRESS: _____

TELEPHONE NO.: _____

CONTACT PERSON: _____

EMAIL ADDRESS: _____

FORM B

DANE COUNTY (Copy this Form as necessary to provide complete information)
EMERGING SMALL BUSINESS REPORT - INVOLVEMENT

COMPANY NAME: _____

PROJECT NAME: _____

BID NO.: _____ BID DUE DATE: _____

ESB NAME: _____

CONTACT PERSON: _____

ADDRESS: _____

PHONE NO & EMAIL.: _____

Indicate percentage of financial commitment to this ESB: _____ % Amount: \$ _____

ESB NAME: _____

CONTACT PERSON: _____

ADDRESS: _____

PHONE NO & EMAIL.: _____

Indicate percentage of financial commitment to this ESB: _____ % Amount: \$ _____

FORM C

**DANE COUNTY
EMERGING SMALL BUSINESS REPORT - CONTACTS**

(Copy this Form as necessary to provide complete information)

COMPANY NAME: _____

PROJECT NAME: _____

BID NO.: _____ BID DUE DATE: _____

	<u>ESB FIRM NAME CONTACTED</u>	<u>DATE</u>	<u>PERSON CONTACTED</u>	<u>DID ESB BID?</u>	<u>ACC- EPT BID?</u>	<u>REASON FOR REJECTION</u>
1)	_____	_____	_____	_____	_____	_____
2)	_____	_____	_____	_____	_____	_____
3)	_____	_____	_____	_____	_____	_____
4)	_____	_____	_____	_____	_____	_____
5)	_____	_____	_____	_____	_____	_____
6)	_____	_____	_____	_____	_____	_____
7)	_____	_____	_____	_____	_____	_____
8)	_____	_____	_____	_____	_____	_____

FORM D

**DANE COUNTY
EMERGING SMALL BUSINESS REPORT - CERTIFICATION STATEMENT**

I, _____, _____ of
Name Title

_____ certify to best of my knowledge and
Company

belief that this business meets Emerging Small Business definition as indicated in Article 9 and
that information contained in this Emerging Small Business Report is true and correct.

Bidder's Signature

Date

Name of Bidding Firm: _____

SECTION 00 41 13

BID FORM

BID NO. 320010

**PROJECT: PHOTOVOLTAIC SYSTEMS
LUSSIER FAMILY HERITAGE CENTER & LAKE FARM PARK**

**TO: DANE COUNTY DEPARTMENT OF PUBLIC WORKS, HIGHWAY &
TRANSPORTATION PROJECT MANAGER
1919 ALLIANT ENERGY CENTER WAY
MADISON, WISCONSIN 53713**

**NOTE: WISCONSIN STATUTE 77.54 (9M) ALLOWS FOR NO SALES & USE TAX ON
THE PURCHASE OF MATERIALS FOR COUNTY PUBLIC WORKS PROJECTS.**

BASE BID - LUMP SUM:

Dane County is inviting Bids for construction services to provide two park shelters, roof-mounted photovoltaic systems and associated infrastructure.. The undersigned, having examined the site where the Work is to be executed and having become familiar with local conditions affecting the cost of the Work and having carefully examined the Drawings and Specifications, all other Construction Documents and Addenda thereto prepared by Dane County Department of Public Works, Highway & Transportation, hereby agrees to provide all labor, materials, equipment and services necessary for the complete and satisfactory execution of the entire Work, as specified in the Construction Documents, for the Base Bid stipulated sum of:

_____ and __/100 Dollars
Written Price

\$ _____
Numeric Price

Receipt of the following addenda and inclusion of their provisions in this Bid is hereby acknowledged:

Addendum No(s). _____ through _____

Dated _____

Dane County Land & Water Resources must have this project completed by December 18, 2020. Assuming this Work can be started by July 27, 2020, what dates can you commence and complete this job?

Commencement Date: _____ Completion Date: _____
(final, not substantial)

I hereby certify that all statements herein are made on behalf of:

(Name of Corporation, Partnership or Person submitting Bid)

Select one of the following:

1. A corporation organized and existing under the laws of the State of _____, or
2. A partnership consisting of _____, or
3. A person conducting business as _____;

Of the City, Village, or Town of _____ of the State of _____.

I have examined and carefully prepared this Bid from the associated Construction Documents and have checked the same in detail before submitting this Bid; that I have full authority to make such statements and submit this Bid in (its) (their) (my) behalf; and that the said statements are true and correct. In signing this Bid, we also certify that we have not, either directly or indirectly, entered into any agreement or participated in any collusion or otherwise taken any action in restraint of free competition; that no attempt has been made to induce any other person or firm to submit or not to submit a Bid; that this Bid has been independently arrived at without collusion with any other bidder, competitor, or potential competitor; that this Bid has not been knowingly disclosed prior to the Bids Due Date to another bidder or competitor; that the above statement is accurate under penalty of perjury.

The undersigned agrees to be qualified as a Best Value Contractor or will prove their exemption. New or updated applications are due on or before Bid Due Date / Time; qualification or rejection will be complete within five (5) business days after Bid Due Date.

The undersigned further agrees to honor the Base Bid and the Alternate Bid(s) for sixty (60) calendar days from date of Award of Contract.

SIGNATURE: _____
(Bid is invalid without signature)

Print Name: _____ Date: _____

Title: _____

Address: _____

Telephone No.: _____ Fax No.: _____

Email Address: _____

Contact Person: _____

END OF SECTION

THIS PAGE IS FOR BIDDERS' REFERENCE
DO NOT SUBMIT WITH BID FORM.

BID CHECK LIST:

These items **must** be included with Bid:

Bid Form

Bid Bond

Fair Labor Practices Certification

DANE COUNTY BEST VALUE CONTRACTING QUALIFICATION

General Contractors & all Subcontractors must be qualified as a Best Value Contractor with the Dane County Public Works Engineering Division. Qualification & listing is not permanent & must be renewed every 24 months. Complete a *Best Value Contracting Application* online at:

pwht.countyofdane.com/bvc_application.aspx

DANE COUNTY VENDOR REGISTRATION PROGRAM

All bidders are strongly encouraged to be a registered vendor with Dane County. Registering allows vendors an opportunity to receive notifications for RFBs & RFPs issued by the County and provides the County with up-to-date company contact information. Complete a new form or renewal online at:

danepurchasing.com/Account/Login?

COUNTY OF DANE

PUBLIC WORKS CONSTRUCTION CONTRACT

Contract No. _____ Bid No. 320010

Authority: 2020 RES - _____

THIS CONTRACT, made and entered into as of the date by which authorized representatives of both parties have affixed their signatures, by and between the County of Dane (hereafter referred to as "COUNTY") and _____ (hereafter, "CONTRACTOR"), and

WITNESSETH:

WHEREAS, COUNTY, whose address is c/o Deputy Public Works Director, 1919 Alliant Energy Center Way, Madison, WI 53713, desires to have CONTRACTOR provide Photovoltaic Systems at the Lussier Family Heritage Center and Lake Farm Park ["the Project"]; and

WHEREAS, CONTRACTOR, whose address is _____ is able and willing to construct the Project, in accordance with the Construction Documents;

NOW, THEREFORE, in consideration of the above premises and the mutual covenants of the parties hereinafter set forth, the receipt and sufficiency of which is acknowledged by each party for itself, COUNTY and CONTRACTOR do agree as follows:

1. CONTRACTOR agrees to construct, for the price of \$_____ the Project and at the CONTRACTOR'S own proper cost and expense to furnish all materials, supplies, machinery, equipment, tools, superintendence labor, insurance, and other accessories and services necessary to complete the Project in accordance with the conditions and prices stated in the [Bid Form, Quote], [General Conditions of Contract, Conditions of Contract], the drawings which include all maps, plats, plans, and other drawings and printed or written explanatory matter thereof, and the specifications therefore as prepared by _____ (hereinafter referred to as "the Architect / Engineer"), and as enumerated in the Project Manual Table of Contents, all of which are made a part hereof and collectively evidence and constitute the Contract.
2. COUNTY agrees to pay the CONTRACTOR in current funds for the performance of the Contract subject to additions and deductions, as provided in the General Conditions of Contract, and to make payments on account thereof as provided in Article entitled, "Payments to Contractor" of the General Conditions of Contract.
3. During the term of this Contract, CONTRACTOR agrees to take affirmative action to ensure equal employment opportunities. The CONTRACTOR agrees in accordance with Wisconsin Statute 111.321 and Chapter 19 of the Dane County Code of Ordinances not to discriminate on the basis of age, race, ethnicity, religion, color, gender, disability, marital status, sexual orientation, national origin, cultural differences, ancestry, physical appearance, arrest record or conviction record, military participation or membership in the national guard, state defense force or any other reserve component of the military forces of the United States, or political beliefs.

Such equal opportunity shall include, but not be limited to, the following: employment, upgrading, demotion, transfer, recruitment, advertising, layoff, termination, training, rates of pay, and any other form of compensation. CONTRACTOR agrees to post in conspicuous places, available to all employees and applicants for employment, notices setting forth the provisions of this paragraph.

4. CONTRACTOR shall file an Affirmative Action Plan with the Dane County Contract Compliance Specialist in accord with Chapter 19 of the Dane County Code of Ordinances. CONTRACTOR must file such plan within fifteen (15) business days of the effective date of this Contract. During the term of this Contract CONTRACTOR shall also provide copies of all announcements of employment opportunities to COUNTY'S Office of Equity & Inclusion, and shall report annually the number of persons, by race, ethnicity, gender, and disability status, which apply for employment and, similarly classified, the number hired and number rejected.

5. During the term of this Contract, all solicitations for employment placed on CONTRACTOR'S behalf shall include a statement to the effect that CONTRACTOR is an "Equal Opportunity Employer".

6. CONTRACTOR agrees to furnish all information and reports required by COUNTY'S Contract Compliance Specialist as the same relate to affirmative action and nondiscrimination, which may include any books, records, or accounts deemed appropriate to determine compliance with Chapter 19, Dane County Code of Ordinances, and the provisions of this Contract.

7. This Contract is intended to be a Contract solely between the parties hereto and for their benefit only. No part of this Contract shall be construed to add to, supplement, amend, abridge or repeal existing rights, benefits or privileges of any third party or parties including, but not limited to, employees of either of the parties.

8. The entire agreement of the parties is contained herein and this Contract supersedes any and all oral agreements and negotiations between the parties relating to the subject matter hereof. The parties expressly agree that the express terms of this Contract shall not be amended in any fashion except in writing, executed by both parties.

9. CONTRACTOR and subcontractors must be qualified as, or apply to be a Best Value Contractor with Dane County Public Works Engineering Division before Bid Due Date. All contractors must be qualified as a Best Value Contractor to perform any work under this Contract.

IN WITNESS WHEREOF, COUNTY and CONTRACTOR, by their respective authorized agents, have caused this Contract and its Schedules to be executed, effective as of the date by which all parties hereto have affixed their respective signatures, as indicated below.

* * * * *

FOR CONTRACTOR:

Signature Date

Printed or Typed Name and Title

Signature Date

Printed or Typed Name and Title

NOTE: If CONTRACTOR is a corporation, Secretary should attest. In accordance with IRS Regulations, unincorporated entities are required to provide either their Social Security or Employer Number in order to receive payment for services rendered.

* * * * *

This Contract is not valid or effectual for any purpose until approved by the appropriate authority designated below, and no work is authorized until the CONTRACTOR has been given notice to proceed by COUNTY'S [Deputy Public Works, Waste & Renewables] Director.

FOR COUNTY:

Joseph T. Parisi, County Executive Date

Scott McDonell, County Clerk Date

AIA[®] Document A310[™] – 2010

Bid Bond

CONTRACTOR:

(Name, legal status and address)

SURETY:

(Name, legal status and principal place of business)

OWNER:

(Name, legal status and address)

BOND AMOUNT:**PROJECT:**

(Name, location or address, and Project number, if any)

This document has important legal consequences. Consultation with an attorney is encouraged with respect to its completion or modification.

Any singular reference to Contractor, Surety, Owner or other party shall be considered plural where applicable.

The Contractor and Surety are bound to the Owner in the amount set forth above, for the payment of which the Contractor and Surety bind themselves, their heirs, executors, administrators, successors and assigns, jointly and severally, as provided herein. The conditions of this Bond are such that if the Owner accepts the bid of the Contractor within the time specified in the bid documents, or within such time period as may be agreed to by the Owner and Contractor, and the Contractor either (1) enters into a contract with the Owner in accordance with the terms of such bid, and gives such bond or bonds as may be specified in the bidding or Contract Documents, with a surety admitted in the jurisdiction of the Project and otherwise acceptable to the Owner, for the faithful performance of such Contract and for the prompt payment of labor and material furnished in the prosecution thereof; or (2) pays to the Owner the difference, not to exceed the amount of this Bond, between the amount specified in said bid and such larger amount for which the Owner may in good faith contract with another party to perform the work covered by said bid, then this obligation shall be null and void, otherwise to remain in full force and effect. The Surety hereby waives any notice of an agreement between the Owner and Contractor to extend the time in which the Owner may accept the bid. Waiver of notice by the Surety shall not apply to any extension exceeding sixty (60) days in the aggregate beyond the time for acceptance of bids specified in the bid documents, and the Owner and Contractor shall obtain the Surety's consent for an extension beyond sixty (60) days.

If this Bond is issued in connection with a subcontractor's bid to a Contractor, the term Contractor in this Bond shall be deemed to be Subcontractor and the term Owner shall be deemed to be Contractor.

When this Bond has been furnished to comply with a statutory or other legal requirement in the location of the Project, any provision in this Bond conflicting with said statutory or legal requirement shall be deemed deleted herefrom and provisions conforming to such statutory or other legal requirement shall be deemed incorporated herein. When so furnished, the intent is that this Bond shall be construed as a statutory bond and not as a common law bond.

Signed and sealed this _____ day of _____

_____	<i>(Contractor as Principal)</i>	_____	<i>(Seal)</i>
<i>(Witness)</i>	_____	_____	<i>(Title)</i>
_____	<i>(Surety)</i>	_____	<i>(Seal)</i>
<i>(Witness)</i>	_____	_____	<i>(Title)</i>

CAUTION: You should sign an original AIA Contract Document, on which this text appears in RED. An original assures that changes will not be obscured.

AIA[®] Document A312[™] – 2010

Performance Bond

CONTRACTOR:

(Name, legal status and address)

SURETY:

(Name, legal status and principal place of business)

OWNER:

(Name, legal status and address)

This document has important legal consequences. Consultation with an attorney is encouraged with respect to its completion or modification.

Any singular reference to Contractor, Surety, Owner or other party shall be considered plural where applicable.

AIA Document A312–2010 combines two separate bonds, a Performance Bond and a Payment Bond, into one form. This is not a single combined Performance and Payment Bond.

CONSTRUCTION CONTRACT

Date:

Amount:

Description:

(Name and location)

BOND

Date:

(Not earlier than Construction Contract Date)

Amount:

Modifications to this Bond: None See Section 16

CONTRACTOR AS PRINCIPAL

Company: *(Corporate Seal)*

SURETY

Company: *(Corporate Seal)*

Signature: _____

Name _____
and Title: _____

Signature: _____

Name _____
and Title: _____

(Any additional signatures appear on the last page of this Performance Bond.)

(FOR INFORMATION ONLY — Name, address and telephone)

AGENT or BROKER:

OWNER'S REPRESENTATIVE:

(Architect, Engineer or other party:)

§ 1 The Contractor and Surety, jointly and severally, bind themselves, their heirs, executors, administrators, successors and assigns to the Owner for the performance of the Construction Contract, which is incorporated herein by reference.

§ 2 If the Contractor performs the Construction Contract, the Surety and the Contractor shall have no obligation under this Bond, except when applicable to participate in a conference as provided in Section 3.

§ 3 If there is no Owner Default under the Construction Contract, the Surety's obligation under this Bond shall arise after

- .1 the Owner first provides notice to the Contractor and the Surety that the Owner is considering declaring a Contractor Default. Such notice shall indicate whether the Owner is requesting a conference among the Owner, Contractor and Surety to discuss the Contractor's performance. If the Owner does not request a conference, the Surety may, within five (5) business days after receipt of the Owner's notice, request such a conference. If the Surety timely requests a conference, the Owner shall attend. Unless the Owner agrees otherwise, any conference requested under this Section 3.1 shall be held within ten (10) business days of the Surety's receipt of the Owner's notice. If the Owner, the Contractor and the Surety agree, the Contractor shall be allowed a reasonable time to perform the Construction Contract, but such an agreement shall not waive the Owner's right, if any, subsequently to declare a Contractor Default;
- .2 the Owner declares a Contractor Default, terminates the Construction Contract and notifies the Surety; and
- .3 the Owner has agreed to pay the Balance of the Contract Price in accordance with the terms of the Construction Contract to the Surety or to a contractor selected to perform the Construction Contract.

§ 4 Failure on the part of the Owner to comply with the notice requirement in Section 3.1 shall not constitute a failure to comply with a condition precedent to the Surety's obligations, or release the Surety from its obligations, except to the extent the Surety demonstrates actual prejudice.

§ 5 When the Owner has satisfied the conditions of Section 3, the Surety shall promptly and at the Surety's expense take one of the following actions:

§ 5.1 Arrange for the Contractor, with the consent of the Owner, to perform and complete the Construction Contract;

§ 5.2 Undertake to perform and complete the Construction Contract itself, through its agents or independent contractors;

§ 5.3 Obtain bids or negotiated proposals from qualified contractors acceptable to the Owner for a contract for performance and completion of the Construction Contract, arrange for a contract to be prepared for execution by the Owner and a contractor selected with the Owner's concurrence, to be secured with performance and payment bonds executed by a qualified surety equivalent to the bonds issued on the Construction Contract, and pay to the Owner the amount of damages as described in Section 7 in excess of the Balance of the Contract Price incurred by the Owner as a result of the Contractor Default; or

§ 5.4 Waive its right to perform and complete, arrange for completion, or obtain a new contractor and with reasonable promptness under the circumstances:

- .1 After investigation, determine the amount for which it may be liable to the Owner and, as soon as practicable after the amount is determined, make payment to the Owner; or
- .2 Deny liability in whole or in part and notify the Owner, citing the reasons for denial.

§ 6 If the Surety does not proceed as provided in Section 5 with reasonable promptness, the Surety shall be deemed to be in default on this Bond seven days after receipt of an additional written notice from the Owner to the Surety demanding that the Surety perform its obligations under this Bond, and the Owner shall be entitled to enforce any remedy available to the Owner. If the Surety proceeds as provided in Section 5.4, and the Owner refuses the payment or the Surety has denied liability, in whole or in part, without further notice the Owner shall be entitled to enforce any remedy available to the Owner.

§ 7 If the Surety elects to act under Section 5.1, 5.2 or 5.3, then the responsibilities of the Surety to the Owner shall not be greater than those of the Contractor under the Construction Contract, and the responsibilities of the Owner to the Surety shall not be greater than those of the Owner under the Construction Contract. Subject to the commitment by the Owner to pay the Balance of the Contract Price, the Surety is obligated, without duplication, for

- .1 the responsibilities of the Contractor for correction of defective work and completion of the Construction Contract;
- .2 additional legal, design professional and delay costs resulting from the Contractor's Default, and resulting from the actions or failure to act of the Surety under Section 5; and
- .3 liquidated damages, or if no liquidated damages are specified in the Construction Contract, actual damages caused by delayed performance or non-performance of the Contractor.

§ 8 If the Surety elects to act under Section 5.1, 5.3 or 5.4, the Surety's liability is limited to the amount of this Bond.

§ 9 The Surety shall not be liable to the Owner or others for obligations of the Contractor that are unrelated to the Construction Contract, and the Balance of the Contract Price shall not be reduced or set off on account of any such unrelated obligations. No right of action shall accrue on this Bond to any person or entity other than the Owner or its heirs, executors, administrators, successors and assigns.

§ 10 The Surety hereby waives notice of any change, including changes of time, to the Construction Contract or to related subcontracts, purchase orders and other obligations.

§ 11 Any proceeding, legal or equitable, under this Bond may be instituted in any court of competent jurisdiction in the location in which the work or part of the work is located and shall be instituted within two years after a declaration of Contractor Default or within two years after the Contractor ceased working or within two years after the Surety refuses or fails to perform its obligations under this Bond, whichever occurs first. If the provisions of this Paragraph are void or prohibited by law, the minimum period of limitation available to sureties as a defense in the jurisdiction of the suit shall be applicable.

§ 12 Notice to the Surety, the Owner or the Contractor shall be mailed or delivered to the address shown on the page on which their signature appears.

§ 13 When this Bond has been furnished to comply with a statutory or other legal requirement in the location where the construction was to be performed, any provision in this Bond conflicting with said statutory or legal requirement shall be deemed deleted herefrom and provisions conforming to such statutory or other legal requirement shall be deemed incorporated herein. When so furnished, the intent is that this Bond shall be construed as a statutory bond and not as a common law bond.

§ 14 Definitions

§ 14.1 **Balance of the Contract Price.** The total amount payable by the Owner to the Contractor under the Construction Contract after all proper adjustments have been made, including allowance to the Contractor of any amounts received or to be received by the Owner in settlement of insurance or other claims for damages to which the Contractor is entitled, reduced by all valid and proper payments made to or on behalf of the Contractor under the Construction Contract.

§ 14.2 **Construction Contract.** The agreement between the Owner and Contractor identified on the cover page, including all Contract Documents and changes made to the agreement and the Contract Documents.

§ 14.3 **Contractor Default.** Failure of the Contractor, which has not been remedied or waived, to perform or otherwise to comply with a material term of the Construction Contract.

§ 14.4 **Owner Default.** Failure of the Owner, which has not been remedied or waived, to pay the Contractor as required under the Construction Contract or to perform and complete or comply with the other material terms of the Construction Contract.

§ 14.5 **Contract Documents.** All the documents that comprise the agreement between the Owner and Contractor.

§ 15 If this Bond is issued for an agreement between a Contractor and subcontractor, the term Contractor in this Bond shall be deemed to be Subcontractor and the term Owner shall be deemed to be Contractor.

§ 16 Modifications to this bond are as follows:

Sample

(Space is provided below for additional signatures of added parties, other than those appearing on the cover page.)

CONTRACTOR AS PRINCIPAL

SURETY

Company: _____

(Corporate Seal)

Company: _____

(Corporate Seal)

Signature: _____
Name and Title: _____
Address _____

Signature: _____
Name and Title: _____
Address _____

CAUTION: You should sign an original AIA Contract Document, on which this text appears in RED. An original assures that changes will not be obscured.



AIA® Document A312™ – 2010

Payment Bond

CONTRACTOR:

(Name, legal status and address)

SURETY:

(Name, legal status and principal place of business)

OWNER:

(Name, legal status and address)

This document has important legal consequences. Consultation with an attorney is encouraged with respect to its completion or modification.

Any singular reference to Contractor, Surety, Owner or other party shall be considered plural where applicable.

AIA Document A312–2010 combines two separate bonds, a Performance Bond and a Payment Bond, into one form. This is not a single combined Performance and Payment Bond.

CONSTRUCTION CONTRACT

Date:

Amount:

Description:

(Name and location)

BOND

Date:

(Not earlier than Construction Contract Date)

Amount:

Modifications to this Bond: None See Section 18

CONTRACTOR AS PRINCIPAL

Company: *(Corporate Seal)*

SURETY

Company: *(Corporate Seal)*

Signature: _____

Name _____
and Title: _____

Signature: _____

Name _____
and Title: _____

(Any additional signatures appear on the last page of this Payment Bond.)

(FOR INFORMATION ONLY — Name, address and telephone)

AGENT or BROKER:

OWNER'S REPRESENTATIVE:

(Architect, Engineer or other party:)

§ 1 The Contractor and Surety, jointly and severally, bind themselves, their heirs, executors, administrators, successors and assigns to the Owner to pay for labor, materials and equipment furnished for use in the performance of the Construction Contract, which is incorporated herein by reference, subject to the following terms.

§ 2 If the Contractor promptly makes payment of all sums due to Claimants, and defends, indemnifies and holds harmless the Owner from claims, demands, liens or suits by any person or entity seeking payment for labor, materials or equipment furnished for use in the performance of the Construction Contract, then the Surety and the Contractor shall have no obligation under this Bond.

§ 3 If there is no Owner Default under the Construction Contract, the Surety's obligation to the Owner under this Bond shall arise after the Owner has promptly notified the Contractor and the Surety (at the address described in Section 13) of claims, demands, liens or suits against the Owner or the Owner's property by any person or entity seeking payment for labor, materials or equipment furnished for use in the performance of the Construction Contract and tendered defense of such claims, demands, liens or suits to the Contractor and the Surety.

§ 4 When the Owner has satisfied the conditions in Section 3, the Surety shall promptly and at the Surety's expense defend, indemnify and hold harmless the Owner against a duly tendered claim, demand, lien or suit.

§ 5 The Surety's obligations to a Claimant under this Bond shall arise after the following:

§ 5.1 Claimants, who do not have a direct contract with the Contractor,

- .1 have furnished a written notice of non-payment to the Contractor, stating with substantial accuracy the amount claimed and the name of the party to whom the materials were, or equipment was, furnished or supplied or for whom the labor was done or performed, within ninety (90) days after having last performed labor or last furnished materials or equipment included in the Claim; and
- .2 have sent a Claim to the Surety (at the address described in Section 13).

§ 5.2 Claimants, who are employed by or have a direct contract with the Contractor, have sent a Claim to the Surety (at the address described in Section 13).

§ 6 If a notice of non-payment required by Section 5.1.1 is given by the Owner to the Contractor, that is sufficient to satisfy a Claimant's obligation to furnish a written notice of non-payment under Section 5.1.1.

§ 7 When a Claimant has satisfied the conditions of Sections 5.1 or 5.2, whichever is applicable, the Surety shall promptly and at the Surety's expense take the following actions:

§ 7.1 Send an answer to the Claimant, with a copy to the Owner, within sixty (60) days after receipt of the Claim, stating the amounts that are undisputed and the basis for challenging any amounts that are disputed; and

§ 7.2 Pay or arrange for payment of any undisputed amounts.

§ 7.3 The Surety's failure to discharge its obligations under Section 7.1 or Section 7.2 shall not be deemed to constitute a waiver of defenses the Surety or Contractor may have or acquire as to a Claim, except as to undisputed amounts for which the Surety and Claimant have reached agreement. If, however, the Surety fails to discharge its obligations under Section 7.1 or Section 7.2, the Surety shall indemnify the Claimant for the reasonable attorney's fees the Claimant incurs thereafter to recover any sums found to be due and owing to the Claimant.

§ 8 The Surety's total obligation shall not exceed the amount of this Bond, plus the amount of reasonable attorney's fees provided under Section 7.3, and the amount of this Bond shall be credited for any payments made in good faith by the Surety.

§ 9 Amounts owed by the Owner to the Contractor under the Construction Contract shall be used for the performance of the Construction Contract and to satisfy claims, if any, under any construction performance bond. By the Contractor furnishing and the Owner accepting this Bond, they agree that all funds earned by the Contractor in the performance of the Construction Contract are dedicated to satisfy obligations of the Contractor and Surety under this Bond, subject to the Owner's priority to use the funds for the completion of the work.

§ 10 The Surety shall not be liable to the Owner, Claimants or others for obligations of the Contractor that are unrelated to the Construction Contract. The Owner shall not be liable for the payment of any costs or expenses of any Claimant under this Bond, and shall have under this Bond no obligation to make payments to, or give notice on behalf of, Claimants or otherwise have any obligations to Claimants under this Bond.

§ 11 The Surety hereby waives notice of any change, including changes of time, to the Construction Contract or to related subcontracts, purchase orders and other obligations.

§ 12 No suit or action shall be commenced by a Claimant under this Bond other than in a court of competent jurisdiction in the state in which the project that is the subject of the Construction Contract is located or after the expiration of one year from the date (1) on which the Claimant sent a Claim to the Surety pursuant to Section 5.1.2 or 5.2, or (2) on which the last labor or service was performed by anyone or the last materials or equipment were furnished by anyone under the Construction Contract, whichever of (1) or (2) first occurs. If the provisions of this Paragraph are void or prohibited by law, the minimum period of limitation available to sureties as a defense in the jurisdiction of the suit shall be applicable.

§ 13 Notice and Claims to the Surety, the Owner or the Contractor shall be mailed or delivered to the address shown on the page on which their signature appears. Actual receipt of notice or Claims, however accomplished, shall be sufficient compliance as of the date received.

§ 14 When this Bond has been furnished to comply with a statutory or other legal requirement in the location where the construction was to be performed, any provision in this Bond conflicting with said statutory or legal requirement shall be deemed deleted herefrom and provisions conforming to such statutory or other legal requirement shall be deemed incorporated herein. When so furnished, the intent is that this Bond shall be construed as a statutory bond and not as a common law bond.

§ 15 Upon request by any person or entity appearing to be a potential beneficiary of this Bond, the Contractor and Owner shall promptly furnish a copy of this Bond or shall permit a copy to be made.

§ 16 Definitions

§ 16.1 Claim. A written statement by the Claimant including at a minimum:

- .1 the name of the Claimant;
- .2 the name of the person for whom the labor was done, or materials or equipment furnished;
- .3 a copy of the agreement or purchase order pursuant to which labor, materials or equipment was furnished for use in the performance of the Construction Contract;
- .4 a brief description of the labor, materials or equipment furnished;
- .5 the date on which the Claimant last performed labor or last furnished materials or equipment for use in the performance of the Construction Contract;
- .6 the total amount earned by the Claimant for labor, materials or equipment furnished as of the date of the Claim;
- .7 the total amount of previous payments received by the Claimant; and
- .8 the total amount due and unpaid to the Claimant for labor, materials or equipment furnished as of the date of the Claim.

§ 16.2 Claimant. An individual or entity having a direct contract with the Contractor or with a subcontractor of the Contractor to furnish labor, materials or equipment for use in the performance of the Construction Contract. The term Claimant also includes any individual or entity that has rightfully asserted a claim under an applicable mechanic's lien or similar statute against the real property upon which the Project is located. The intent of this Bond shall be to include without limitation in the terms "labor, materials or equipment" that part of water, gas, power, light, heat, oil, gasoline, telephone service or rental equipment used in the Construction Contract, architectural and engineering services required for performance of the work of the Contractor and the Contractor's subcontractors, and all other items for which a mechanic's lien may be asserted in the jurisdiction where the labor, materials or equipment were furnished.

§ 16.3 Construction Contract. The agreement between the Owner and Contractor identified on the cover page, including all Contract Documents and all changes made to the agreement and the Contract Documents.

§ 16.4 **Owner Default.** Failure of the Owner, which has not been remedied or waived, to pay the Contractor as required under the Construction Contract or to perform and complete or comply with the other material terms of the Construction Contract.

§ 16.5 **Contract Documents.** All the documents that comprise the agreement between the Owner and Contractor.

§ 17 If this Bond is issued for an agreement between a Contractor and subcontractor, the term Contractor in this Bond shall be deemed to be Subcontractor and the term Owner shall be deemed to be Contractor.

§ 18 Modifications to this bond are as follows:

(Space is provided below for additional signatures of added parties, other than those appearing on the cover page.)

CONTRACTOR AS PRINCIPAL

Company: _____

(Corporate Seal)

SURETY

Company: _____

(Corporate Seal)

Signature: _____

Name and Title: _____

Address _____

Signature: _____

Name and Title: _____

Address _____

CAUTION: You should sign an original AIA Contract Document, on which this text appears in RED. An original assures that changes will not be obscured.

SECTION 00 72 12

GENERAL CONDITIONS OF CONTRACT

TABLE OF CONTENTS

1. CONSTRUCTION DOCUMENTS 2
2. DEFINITIONS 2
3. ADDITIONAL INSTRUCTIONS AND DRAWINGS 2
4. SHOP DRAWINGS, PRODUCT DATA AND SAMPLES 3
5. CUTTING AND PATCHING 4
6. CLEANING UP 4
7. USE OF SITE 4
8. MATERIALS AND WORKMANSHIP 5
9. CONTRACTOR’S TITLE TO MATERIALS 5
10. “OR EQUAL” CLAUSE 5
11. PATENTS AND ROYALTIES 6
12. SURVEYS, PERMITS, REGULATIONS AND TAXES 6
13. CONTRACTOR’S OBLIGATIONS AND SUPERINTENDENCE 7
14. WEATHER CONDITIONS 8
15. PROTECTION OF WORK AND PROPERTY 8
16. INSPECTION AND TESTING OF MATERIALS 8
17. REPORTS, RECORDS AND DATA 9
18. CHANGES IN THE WORK 9
19. EXTRAS 10
20. TIME FOR COMPLETION 10
21. CORRECTION OF WORK 10
22. SUBSURFACE CONDITIONS FOUND DIFFERENT 11
23. RIGHT OF DEPARTMENT TO TERMINATE CONTRACT 11
24. CONSTRUCTION SCHEDULE AND PERIODIC ESTIMATES 11
25. PAYMENTS TO CONTRACTOR 12
26. WITHHOLDING OF PAYMENTS 13
27. ACCEPTANCE OF FINAL PAYMENT AS RELEASE 14
28. PAYMENTS BY CONTRACTOR 14
29. CONTRACT SECURITY 14
30. ASSIGNMENTS 14
31. MUTUAL RESPONSIBILITY OF CONTRACTORS 15
32. SEPARATE CONTRACTS 15
33. SUBCONTRACTS 15
34. PROJECT MANAGER’S AUTHORITY 16
35. CONSULTANT’S AUTHORITY 16
36. STATED ALLOWANCES 16
37. ESTIMATES OF QUANTITIES 17
38. LANDS AND RIGHTS-OF-WAY 17
39. GENERAL GUARANTEE 17
40. CONFLICTING CONDITIONS 18
41. NOTICE AND SERVICE THEREOF 18
42. PROTECTION OF LIVES AND HEALTH 18
43. AFFIRMATIVE ACTION PROVISION AND MINORITY / WOMEN /
DISADVANTAGED BUSINESS ENTERPRISES 18
44. COMPLIANCE WITH FAIR LABOR STANDARDS 19
45. DOMESTIC PARTNERSHIP BENEFITS 19
46. USE AND OCCUPANCY PRIOR TO ACCEPTANCE 19
47. MINIMUM WAGES 20
48. CLAIMS 20
49. ANTITRUST AGREEMENT 20
50. INSURANCE 20
51. WISCONSIN LAW CONTROLLING 22

1. CONSTRUCTION DOCUMENTS

- A. Construction Documents, listed in Table of Contents of this Specification volume shall form part of this Contract and provisions of Construction Documents shall be as binding upon parties as if they were fully set forth in Contract itself.
- B. These shall also be considered as part of Construction Documents: Addenda, including additions and modifications incorporated in such addenda before execution of Contract; requests for information; construction bulletins; change orders; and written interpretations by Architect / Engineer or Public Works Project Manager that are made after execution of Contract.
- C. Construction Documents are complementary, and what is required by one shall be as binding as if required by all. Intent of Construction Documents is to include all labor, materials and equipment necessary for proper execution of the Work.

2. DEFINITIONS

- A. These terms as used in this Contract are respectively defined as follows:
 - 1. All uses of term “County” in Construction Documents shall mean Dane County.
 - 2. All uses of term “Department” in Construction Documents shall mean Department of Public Works, Highway & Transportation,, which is a unit of Dane County government. Department is County agency overseeing Contract with Contractor.
 - 3. Public WorksProject Manager is appointed by and responsible to Department. Public Works Project Manager has authority to act on behalf of Department and will sign change orders, payment requests and other administrative matters related to projects.
 - 4. Public Works Project Manager is responsible for supervision, administration and management of field operations involved in construction phase of this Work.
 - 5. Term “Work” includes all labor, equipment and materials necessary to produce project required by Construction Documents.
 - 6. Term “Substantial Completion” is date when project or specified area of project is certified by Architect / Engineer that construction is sufficiently completed, in accordance with Construction Documents, and as modified by any subsequent changes agreed to by parties, so that County may occupy project or specified area of project for use for which it was intended subject to permit approval for occupancy.
 - 7. Contractor is person, firm, or corporation with whom County makes Contract. Though multiple contracts may be involved, Construction Documents treat them throughout as if each were of singular number.

3. ADDITIONAL INSTRUCTIONS AND DRAWINGS

- A. Contractor may be furnished additional instructions and detail drawings as necessary to carry out the Work included in Contract. Additional drawings and instructions thus supplied to Contractor will coordinate with Construction Documents and will be so prepared that they can be reasonably interpreted as part thereof. Contractor shall carry out the Work in accordance with additional detail drawings and instructions.

4. SHOP DRAWINGS, PRODUCT DATA AND SAMPLES

- A. Unless otherwise specified, Contractor shall submit three (3) copies of all Shop Drawings for each submission, until receiving final approval. After final approval, provide five (5) additional copies for distribution and such other copies as may be required.
- B. Contractor shall submit, on an on-going basis and as directed, Product Data such as brochures that shall contain catalog cuts and specifications of all furnished mechanical and electrical equipment. After Architect / Engineer's approval, one (1) copy shall remain in Architect / Engineer's file, one (1) kept at Department's office and one (1) kept at job site by Contractor for reference purposes.
- C. Samples shall consist of physical examples furnished by Contractor in sufficient size and quantity to illustrate materials, equipment or workmanship, and to establish standards to compare the Work.
 - 1. Submit Samples in sufficient quantity (minimum of two (2)) to permit Architect / Engineer to make all necessary tests and of adequate size showing quality, type, color range, finish, and texture. Label each Sample stating material, type, color, thickness, size, project name, and Contractor's name.
 - 2. Submit transmittal letter requesting approval, and prepay transportation charges to Architect / Engineer's office on samples forwarded.
 - 3. Materials installed shall match approved Samples.
- D. Contractor shall review Shop Drawings and place their dated stamp thereon to evidence their review and approval and shall submit with reasonable promptness and in orderly sequence to cause no delay in the Work or in work of any other contractor. At time of submission, Contractor shall inform Architect / Engineer in writing of any deviation in Shop Drawings or Samples from requirements of Construction Documents. Architect / Engineer will not consider partial lists.
- E. Architect / Engineer will review and approve or reject Shop Drawings with reasonable promptness to cause no delay. Architect / Engineer's approval shall not relieve Contractor from responsibility for errors or omissions in Shop Drawings.
- F. Contractor shall not commence any work requiring Shop Drawing, Product Data or Sample submission until Architect / Engineer has approved submission. All such work shall be in accordance with approved Shop Drawings, Product Data and Samples.
- G. Contractor shall keep on site of the Work, approved or conformed copy of Shop Drawings and shall at all times give Department access thereto.
- H. By stamping and submitting Shop Drawings, Product Data and Samples, Contractor thereby represents that he or she has or will determine and verify all field measurements, field construction criteria, materials, catalog numbers, and similar data and that he or she has checked and coordinated each Shop Drawing, Product Data and Sample with requirements of the Work and of Construction Documents. Architect / Engineer shall return without examination, Shop Drawings, Product Data and Samples not so noted.
- I. All Shop Drawings from any one Contractor should be numbered consecutively and on cover sheet shall bear name and location of project, name of Contractor, date of submittal and date of each correction or revision and associated Specification section and page number.

5. CUTTING AND PATCHING

- A. Contractor shall be responsible for all cutting, fitting or patching required to complete the Work or to make its parts fit together properly.
- B. Contractor shall not damage or endanger portion of the Work or fully or partially completed construction of County or separate contractors by cutting, patching or otherwise altering such construction, or by excavation. Contractor shall not cut or otherwise alter such construction by County or separate contractor except with written consent of County and of such separate contractor; such consent shall not be unreasonably withheld. Contractor shall not withhold unreasonably from County or separate contractor, Contractor's consent to cutting or otherwise altering the Work.

6. CLEANING UP

- A. Contractor shall keep premises and surrounding area free from accumulation of waste materials or rubbish caused by operations under Contract. Contractor shall remove from and about the Work waste materials, rubbish, Contractor's tools, construction equipment, machinery, and surplus materials at completion of the Work. Contractor shall maintain streets and sidewalks around the Work site in clean condition. Contractor shall remove all spillage and prevent tracking of spillage arising from performance of the Work, into, out of, and within the Work site. Contractor shall establish regular maintenance program of sweeping, vacuuming and / or hosing to minimize accumulation of dirt and dust upon such areas.
- B. If Contractor fails to clean up as directed in Construction Documents, County may do so and shall charge Contractor cost thereof.
- C. Contractor shall be responsible for broken windows and glass, and at completion of the Work shall replace such damaged or broken windows and glass. After replacing damaged or broken windows and glass, Contractor shall remove all labels, wash and polish both sides of all windows and glass.
- D. In addition to general cleaning (sweeping, vacuuming and / or hosing, as is appropriate to work surface), Contractor shall perform following final cleaning for all trades at completion of the Work:
 - 1. Remove temporary protections;
 - 2. Remove marks, stains, fingerprints and other soil or dirt from painted, decorated and finished woodwork and wall surfaces;
 - 3. Remove spots, plaster, soil and paint from ceramic tile, marble and other finished materials, and wash or wipe clean;
 - 4. Clean fixtures, cabinet work and equipment, removing stains, paint, dirt and dust, and leave same in undamaged, new condition;
 - 5. Clean aluminum in accordance with recommendations of manufacturer; and
 - 6. Clean resilient floors thoroughly with well-rinsed mop containing only enough moisture to clean off any surface dirt or dust and buff dry by machine to bring surfaces to sheen.

7. USE OF SITE

- A. Contractor shall provide County and Architect / Engineer access to the Work under all circumstances.

- B. Contractor shall confine operations at site to areas permitted by County, law, ordinance, permits and Construction Documents and shall not unreasonably encumber site with materials or equipment. Contractor shall assure free, convenient, unencumbered, direct and safe access to all properties adjacent to the Work for County, its employees, invitees and guests.

8. MATERIALS AND WORKMANSHIP

- A. Contractor shall perform all work and furnish all supplies and materials, machinery, equipment, facilities and means, necessary to complete the Work required by this Contract, within time specified, in accordance with provisions of Construction Documents.
- B. All equipment and materials incorporated in the Work covered by this Contract are to be new; use recycled and / or recovered materials to extent that such use is technically and economically feasible. Recovered materials are products recovered from solid waste in form identical to original form for use that is same as, or similar to original use. Recycled materials are products manufactured from solid waste.
- C. If requested, Contractor shall furnish satisfactory evidence as to kind and quality of construction materials proposed or used. Contractor shall furnish to Architect / Engineer, for approval, manufacturer name and model, performance capacities and other pertinent information of machinery, mechanical, electrical or other types of equipment, which Contractor plans to install.
- D. If not otherwise provided, materials and labor called for in this Contract shall be provided and performed in accordance with established practice and standards recognized by Architects, Engineers, Department, and construction industry.
- E. Reference to “Standard” specifications of any association or manufacturer, or codes of County authorities, intends most recent printed edition or catalog in effect on date that corresponds with date of Construction Documents.
- F. Whenever reference is made in Specifications that work shall be “performed”, “applied”, in accordance with “manufacturer’s directions or instructions”, Contractor to whom those instructions are directed shall furnish three (3) printed copies of such instructions to Architect / Engineer before execution of the Work.

9. CONTRACTOR’S TITLE TO MATERIALS

- A. Contractor or any subcontractor shall not purchase materials or supplies for the Work subject to any chattel mortgage or under conditional sale contract or other agreement by which seller retains interest. Contractor warrants that all materials and supplies used in the Work are free from all liens, claims or encumbrances and Contractor has good title to them.

10. “OR EQUAL” CLAUSE

- A. Whenever equipment or materials are identified on Drawings or in Specifications by reference to manufacturer’s or vendor’s name, trade name, catalog number, and other identifying information, it is intended to establish standards; and any equipment or material of other manufacturers and vendors which will perform adequately duties imposed by general design will be considered equally accepted provided equipment or material so proposed is, in opinion of Architect / Engineer, of equal substance and function. Architect / Engineer and Department shall provide written approval before Contractor may purchase or install it.

- B. Equipment or materials of manufacturers, other than those named, may be used only upon following conditions:
1. That, in opinion of Architect / Engineer and Department, proposed material or equipment item is fully equal or superior (in design, materials, construction, workmanship, performance, finish, etc.) to named item. No compromise in quality level, however small, is acceptable.
 2. That, in substituting materials or equipment, Contractor assumes responsibility for any changes in system or for modifications required in adjacent or related work to accommodate such substitution despite Architect / Engineer's and Department's approval, and all costs growing out of approval of "or equal" items shall be responsibility of Contractor. No extra costs resulting from such approval shall become responsibility of Department, Architect / Engineer or any other separate Contractor.
 3. It shall be understood that use of materials or equipment other than those specified, or approved equal by Architect / Engineer and Department, shall constitute violation of Contract, and that Architect / Engineer and Department shall have right to require removal of such materials or equipment and their replacement with specified materials or equipment at Contractor's expense.
 4. Product and manufacturer named first in Specifications or on information shown on Drawings is basis of selection of manufactured items and equipment, particularly mechanical equipment. In using other than first named products or manufacturers, including those specified as additionally approved or acceptable, Contractor assumes responsibility for any changes in system and for modifications in any work required to accommodate them. Architect / Engineer's approval of such additionally acceptable products or manufacturers, either in Specifications or in Addendum, does not relieve Contractor from obligation to coordinate such optional products with other Contractors, whose work may be affected by them, and to pay all additional costs resulting from their inclusion into the Work. Contractor's liability shall include payment of Architect / Engineer's fees for any additional services made necessary by or directly connected to such product changes. No extra costs resulting from such changes shall become responsibility of Department, Architect / Engineer or any other separate Contractor.
- C. No request for approval of "or equal" materials will be entertained except from Contractor. Identify any request for substitution as substitution on Contractor's letter of transmittal and give reasons for substitution. Department may in its sole discretion allow substitutions of materials.

11. PATENTS AND ROYALTIES

- A. If Contractor uses any design, device or material covered by letters, patent or copyright, it is mutually agreed and understood, that, without exception, contract prices shall include all royalties or costs arising from use of such design, device or materials, in any way involved in the Work.
- B. Contractor shall indemnify and save harmless County from any and all claims for infringement by reason of use of such patent or copyright in connection with the Work agreed to be performed under this Contract, and shall indemnify County for any cost, expense or damage which it may be obliged to pay by reason of such infringement at any time during prosecution of the Work or after completion of the Work.

12. SURVEYS, PERMITS, REGULATIONS AND TAXES

- A. Department will furnish to Contractor all site, topography and property surveys necessary for execution of the Work.
- B. Contractor shall procure all permits, licenses and approvals necessary for execution of this Contract.
- C. Contractor shall give all notices and comply with all State of Wisconsin, Federal and local laws, codes, rules and regulations relating to performance of the Work, protection of adjacent property, and maintenance of passageways, guard fences or other protective facilities.
- D. Contractor does not need to pay State and local sales & use taxes. See Wisconsin Statute 77.54 (9m).
- E. Contractor shall promptly notify Architect / Engineer of any variances of Drawings or Specifications with that of any State of Wisconsin, federal or local law, code, rule or regulation. Upon such notification, Architect / Engineer will require correction of variance to comply with applicable law, code, rule or regulation at no additional cost to Contractor.
- F. Work under this Contract shall comply with all applicable State of Wisconsin, Federal and local laws, codes and regulations.
- G. Contractor shall pay charges for water, sewer and other utility connections made by municipalities where required by Specifications.

13. CONTRACTOR'S OBLIGATIONS AND SUPERINTENDENCE

- A. Contractor shall provide and pay for all materials, labor, tools, equipment, transportation and superintendence necessary to execute, complete and deliver the Work within specified time. Contractor agrees to secure at their own expense all personnel necessary to carry out the Work. Such personnel shall not be deemed County employees nor shall they have or be deemed to have any direct contractual relationship with County.
- B. Performance of any work necessary after regular working hours, on Sundays or Legal Holidays shall be without additional expense to County. Performance of any work at site at other than normal working hours must be coordinated with Public Works Project Manager.
- C. Contractor shall furnish, erect, maintain and remove such temporary works as may be required.
- D. Contractor shall observe, comply with, and be subject to all terms, conditions, requirements and limitations of Construction Documents.
- E. At the Work site, Contractor shall give personal superintendence to the Work or shall employ construction superintendent or foreman, experienced in character of work covered by Contract, who shall have full authority to act for Contractor. Understand that such superintendent or foreman shall be acceptable to Architect / Engineer and Department.
- F. Remove from project or take other corrective action upon notice from Architect / Engineer or Department for Contractor's employees whose work is considered by Architect / Engineer or Department to be unsatisfactory, careless, incompetent, unskilled or otherwise objectionable.

- G. Contractor and subcontractors shall be required to conform to Labor Laws of State of Wisconsin and various acts amendatory and supplementary thereto and to other laws, ordinances and legal requirements applicable to the Work.
- H. Presence and observation of the Work by Architect / Engineer or Public Works Project Manager shall not relieve Contractor of any obligations.

14. WEATHER CONDITIONS

- A. In event of temporary suspension of work, or during inclement weather, or whenever Architect / Engineer shall direct, Contractor shall, and shall cause subcontractors to protect carefully all work and materials against damage or injury from weather. If, in opinion of Architect / Engineer or Department, any work or materials that have been damaged or injured due to failure on part of Contractor or any subcontractors so to protect the Work, such materials shall be removed and replaced at expense of Contractor.

15. PROTECTION OF WORK AND PROPERTY

- A. Contractor shall at all times safely guard County's property from injury or loss in connection with this Contract. Contractor shall at all times safely guard and protect the Work, and adjacent property, from damage. Contractor shall replace or make good any such damage, loss or injury unless such is caused directly by errors contained in Contract, or by County, or County's duly authorized representative.
- B. Contractor may act diligently, without previous instructions from Architect / Engineer and / or Department, in emergency that threatens loss or injury of property, or safety of life. Contractor shall notify Architect / Engineer and / or Department immediately thereafter. Promptly submit any claim for compensation by Contractor due to such extra work to Architect / Engineer and / or Department for approval as provided for in Article 18 herein.

16. INSPECTION AND TESTING OF MATERIALS

- A. Authorized representatives and agents of County government shall have access at all times to the Work wherever it is in preparation or progress and Contractor shall provide facilities for such access and for inspection.
- B. Should it be considered necessary or advisable at any time before final acceptance of the Work to make examination of work already completed, by removing or tearing out same, Contractor shall upon request, promptly furnish all necessary facilities, labor and materials. If such work is found to be defective in any aspect, due to fault of Contractor or subcontractors thereof, Contractor shall assume all expenses of such examination and of satisfactory reconstruction. Contractor will be reimbursed for such examination and replacement in accordance with Article 18 - A.3., of these General Conditions of Contract if such work is found to meet requirements of Contract.
- C. If Specifications, Architect / Engineer's, or Public Works Project Manager's instructions require any work to be specially tested or approved, Contractor shall give Architect / Engineer and Public Works Project Manager timely notice of its readiness for testing or inspection. Test all materials and equipment requiring testing in accordance with accepted or specified standards, as applicable. Architect / Engineer shall recommend laboratory or inspection agency and Department will select and pay for all initial laboratory inspection

services. Should retesting be required, due to failure of initial testing, cost of such retesting shall be borne by Contractor.

- D. Cost of any testing performed by manufacturers or Contractor for substantiating acceptability of proposed substitution of materials and equipment, or necessary conformance testing in conjunction with manufacturing processes or factory assemblage, shall be borne by Contractor or manufacturer responsible.

17. REPORTS, RECORDS AND DATA

- A. Contractor shall submit to Architect / Engineer and Public Works Project Manager such schedule of quantities and costs, progress schedules, payrolls, reports, estimates, invoices, records and other data as either may request concerning work performed or to be performed under this Contract.

18. CHANGES IN THE WORK

- A. Make no changes, except in cases of emergency, in the Work covered by approved Construction Documents without having prior written approval of Department. Charges or credits for the Work covered by approved change shall be determined by one of these methods:
1. Unit bid prices previously approved.
 2. Agreed lump sum based on actual cost of:
 - a) Labor, including foremen, and all fringe benefits that are associated with their wages.
 - b) Materials entering permanently into the Work.
 - c) Ownership or rental cost of construction tools and equipment during time of use on extra work.
 - d) Power and consumable supplies for operation of power equipment.
 - e) Workmen's Compensation Insurance, Contractor's Public Liability and Property Damage Insurance, and Comprehensive Automobile Liability Insurance.
 - f) Social Security and old age and unemployment contributions.
 - g) Add to cost under (2), fixed fee to be agreed upon, but not to exceed fifteen percent (15%) of actual cost of work performed with their own labor force. Fee shall be compensation to cover cost of supervision, overhead, bond, profit and any other general expense.
 - h) On that portion of the Work under (2) done under subcontract, Contractor may include not over seven and one-half percent (7½%) for supervision, overhead, bond, profit and any other general expense.
 - i) Department may require correct amount of costs with supporting vouchers; Contractor shall keep and present in such form as directed.
 3. Cost-plus work, with not-to-exceed dollar limit, based on actual cost of:
 - a) Labor, including foremen, and all fringe benefits that are associated with their wages.
 - b) Materials entering permanently into the Work.
 - c) Ownership or rental cost of construction tools and equipment during time of use on extra work. Rental cost cannot exceed fifty percent (50%) replacement value of rented equipment.
 - d) Power and consumable supplies for operation of power equipment.
 - e) Workmen's Compensation Insurance, Contractor's Public Liability and Property Damage Insurance, and Comprehensive Automobile Liability Insurance.
 - f) Social Security and old age and unemployment contributions.
 - g) To cost under (3), there shall be added fixed fee to be agreed upon but not to exceed fifteen percent (15%) of actual cost of work performed with their own labor force.

Fee shall be compensation to cover cost of supervision, overhead, bond, profit, and any other general expense.

- h) On that portion of the Work under (3) done under subcontract, Contractor may include not over seven and one-half percent (7½%) for supervision, overhead, bond, profit, and any other general expense.
 - i) Contractor shall keep and present, in such form as directed, correct amount of cost together with such supporting vouchers as may be required by Department.
- B. If Contractor claims that by any instructions given by Architect / Engineer, Department, by drawings or otherwise, regarding performance of the Work or furnishing of material under Contract, involves extra cost, Contractor shall give Department written notice of cost thereof within two (2) weeks after receipt of such instructions and in any event before proceeding to execute work, unless delay in executing work would endanger life or property.
- C. No claim for extra work or cost shall be allowed unless it was done in pursuance of written Change Order from Architect / Engineer and approved by Department, as previously mentioned, and claim presented with payment request submitted after changed or extra work is completed.
- D. Negotiation of cost for change in the Work shall not be cause for Contractor to delay prosecution of the Work if Contractor has been authorized in writing by Public Works Project Manager to proceed.

19. EXTRAS

- A. Without invalidating Contract, Department may order extra work or make changes by altering, adding to or deducting from the Work, contract sum being adjusted in accordance with Article 18 herein.

20. TIME FOR COMPLETION

- A. Contractor agrees that the Work shall be prosecuted regularly and diligently and complete the Work as stated in Construction Documents.

21. CORRECTION OF WORK

- A. All work, all materials whether incorporated in the Work or not, and all processes of manufacture shall at all times and places be subject to inspection of Architect / Engineer and Public Works Project Manager who shall be judge of quality and suitability of the Work, materials, and processes of manufacture for purposes for which they are used. Should they fail to meet Architect / Engineer's and Public Works Project Manager's approval they shall be reconstructed, made good, replaced or corrected, by Contractor at Contractor's expense. Immediately remove all rejected material from site.
- B. If Contractor defaults or neglects to carry out the Work in accordance with Construction Documents or fails to perform any provision of Contract, Department may, after ten (10) business days' written notice to Contractor and without prejudice to any other remedy County may have, make good such deficiencies. In such case, appropriate Change Order shall be issued deducting from Contractor's payments then or thereafter, cost of correcting such deficiencies, including cost of Architect / Engineer's additional services made necessary by such default, neglect or failure.

22. SUBSURFACE CONDITIONS FOUND DIFFERENT

- A. If Contractor encounters subsurface or latent conditions at site materially differing from those shown on Drawings or indicated in Specifications, Contractor shall immediately give notice to Architect / Engineer and Public Works Project Manager of such conditions before they are disturbed. Architect / Engineer will thereupon promptly investigate conditions, and if Architect / Engineer finds that they materially differ from those shown on Drawings or indicated in Specifications, Architect / Engineer will at once make such changes as necessary, any increase or decrease of cost resulting from such changes to be adjusted in manner provided in above Article 18 entitled "Changes in the Work".

23. RIGHT OF DEPARTMENT TO TERMINATE CONTRACT

- A. In event that any provisions of this Contract are violated by Contractor or by any subcontractors, County may serve written notice upon Contractor and Surety of its intention to terminate Contract, such notice to contain reasons for such intention to terminate Contract, and unless within ten (10) business days after serving of such notice upon Contractor, such violation or delay shall cease and satisfactory arrangement or correction be made, Contract shall, upon expiration of said ten (10) business days, cease and terminate.
- B. In event of any such termination, County shall immediately serve notice thereof upon Surety and Contractor, and Surety shall have right to take over and perform Contract subject to County's approval; provided, however, that if Surety does not commence performance thereof within ten (10) business days from date of mailing to such Surety of notice of termination, County may take over the Work and prosecute same to completion by contract, or by force account, at expense of Contractor; Contractor and Surety shall be liable to County for any excess cost occasioned County thereby, and in such event County may take possession of and utilize in completing the Work, such materials and equipment as may be on the Work site and therefore necessary.

24. CONSTRUCTION SCHEDULE AND PERIODIC ESTIMATES

- A. Contractor shall be responsible for Construction Schedule and coordination. Immediately after execution and delivery of Contract and before making first payment, Contractor shall notify all subcontractors to furnish all required information to develop Construction Schedule. Contractor and all subcontractors associated with the Work shall furnish following information from each Division of Specifications:
1. List of construction activities;
 2. Start, finish and time required for completion of each activity;
 3. Sequential relationships between activities;
 4. Identify all long lead-time items, key events, meetings or activities such as required submittals, fabrication and delivery, procurement of materials, installation and testing;
 5. Weekly definition of extent of work and areas of activity for each trade or Subcontract; and
 6. Other information as determined by Public Works Project Manager.
- B. In addition to above requested items, Contractor shall request delivery dates for all County-furnished equipment, materials or labor. This shall include any work handled by Department under separate contracts such as asbestos abatement, air and water balancing, etc. Indicate on Construction Schedule these associated delivery and installation dates.
- C. Progress Reporting:

1. Contractor shall update and publish Construction Schedule on monthly basis. Revisions to Schedule shall be by Contractor and made in same detail as original Schedule and accompanied by explanation of reasons for revision; and shall be subject to approval by Department.
 2. Failure of Contractor to keep Schedule in updated format shall result in County hiring firm specializing in construction schedule development and deducting those costs associated with updating process from payments due Contractor.
 3. Contractor shall submit show actual percentage of each activity completed, estimated future progress, and anticipated completion time.
- D. Responsibility for timely completion requires:
1. Contractor and subcontractors understand that performance of each is interdependent upon performance of others.
 2. Whenever it becomes apparent from current schedule, that phasing or progress completion dates will not be met, Contractor must take some or all following actions at no additional cost to County:
 - a) Increase construction labor in such quantities and crafts as will eliminate backlog of work.
 - b) Increase number of working hours per shift, shifts per working day, working days per week, amount of construction equipment, or any combination of foregoing to eliminate backlog of work.
 - c) Reschedule work (yet remain in conformance with Drawings and Specifications).
 3. Prior to proceeding with any of above actions, Contractor shall notify Public Works Project Manager.
- E. Maintain current Construction Schedule at all times. Revise Construction Schedule in same detail as original and accompany with explanation of reasons for revision. Schedule shall be subject to approval by Architect / Engineer and Public Works Project Manager.

25. PAYMENTS TO CONTRACTOR

- A. Contractor shall provide:
1. Detailed estimate giving complete breakdown of contract price by Specification Division; and
 2. Periodic itemized estimates of work done for purpose of making partial payments thereon.
- B. Submit these estimates for approval first to Architect / Engineer, then to Public Works Project Manager. Costs employed in making up any of these schedules are for determining basis of partial payments and not considered as fixing basis for additions to or deductions from Contract price.
- C. County will make partial payments to Contractor for value, proportionate to amount of Contract, of all labor and material incorporated in the Work during preceding calendar month upon receipt of Application and Certificate for Payment form from Architect / Engineer and approval of Department.
- D. Contractor shall submit for approval first to Architect / Engineer, and then to Public Works Project Manager all Application and Certificate for Payment forms. If requested, Application and Certificate for Payment shall be supported by such additional evidence as may be required, showing Contractor's right to payment claimed.

- E. Application and Certificate for Payment for preparatory work and materials delivered and suitably stored at site to be incorporated into the Work at some future period, will be given due consideration. Requesting payment for materials stored off site, may be rejected, however, if deemed essential for reasons of job progress, protection, or other sufficient cause, requests will be considered, conditional upon submission by Contractor of bills of sale, photographs and such other procedures as will adequately protect County's interest such as storage in bonded warehouse with adequate coverage. If there is any error in payment, Contractor is obligated to notify Department immediately, but no longer than ten (10) business days from receipt of payment.
- F. Payments by County will be due within forty-five (45) business days after receipt by Department of Application and Certificate for Payment.
- G. County will retain five percent (5%) of each Application and Certificate for Payment until final completion and acceptance of all the Work covered by Contract. However, anytime after fifty percent (50%) of the Work has been furnished and installed at site, County will make remaining payments in full if Architect / Engineer and Public Works Project Manager find that progress of the Work corresponds with Construction Schedule. If Architect / Engineer and Public Works Project Manager find that progress of the Work does not correspond with Construction Schedule, County may retain up to ten percent (10%) of each Application and Certificate for Payment for the Work completed.
- H. All material and work covered by partial payments made shall become sole property of County, but this provision shall not be construed as relieving Contractor from sole responsibility for care and protection of materials and work upon which payments have been made, or restoration of any damaged work, or as waiver of right of County to require fulfillment of all of terms of Contract.
- I. County will make final payment within sixty (60) calendar days after final completion of the Work, and will constitute acceptance thereof. Submit Equal Benefits Compliance Payment Certification with final pay request. Payment may be denied if Certification is not included.
- J. County may make payment in full, including retained percentages and less authorized deductions, upon completion and acceptance of each Division where price is stated separately in Contract.
- K. Every contractor engaged in performance of any contract for Department of Public Works, Highway & Transportation shall submit to this Department, as requested and with final application for payment for work under said contract, affidavit(s) as required to prove that all debts and claims against this Work are paid in full or otherwise satisfied, and give final evidence of release of all liens against the Work and County.

26. WITHHOLDING OF PAYMENTS

- A. County, after having served written notice on said Contractor, may either pay directly any unpaid bills of which Department has written notice, or withhold from Contractor's unpaid compensation sum of money deemed reasonably sufficient to pay any and all such lawful claims until satisfactory evidence is furnished that all liabilities have been fully discharged; whereupon, payment to Contractor shall be resumed in accordance with terms of this Contract, but in no event shall these provisions be construed to impose any obligations upon County to either Contractor or Contractor's Surety.

- B. In paying any unpaid bills of Contractor, County shall be deemed agent of Contractor, and any payment so made by County, shall be considered as payment made under Contract by County to Contractor and County shall not be liable to Contractor for any such payment made in good faith.
- C. Contractor shall indemnify, hold harmless and defend Dane County, its boards, commissions, agencies, officers, employees and representatives from all claims growing out of lawful demands of subcontractors, laborers, workers, mechanics, material men, and furnishers of machinery and parts thereof, equipment, power tools, and all supplies, including commissary, incurred in performance of this Contract.
- D. At Department's request, Contractor shall furnish satisfactory evidence that all obligations of nature designated above have been paid, discharged or waived.

27. ACCEPTANCE OF FINAL PAYMENT AS RELEASE

- A. Making of final payment shall constitute waiver of all claims by County except those arising from:
 - 1. Unsettled lien;
 - 2. Faulty or defective work appearing after substantial completion;
 - 3. Failure of the Work to comply with requirements of Construction Documents; or
 - 4. Terms of any special guarantees required by Construction Documents.
- B. Acceptance of final payment shall constitute waiver of all claims by Contractor.

28. PAYMENTS BY CONTRACTOR

- A. Contractor shall pay following not later than fifth (5th) business day following each payment received from County:
 - 1. All transportation and utility services rendered;
 - 2. All materials, tools, and other expendable equipment that have been delivered at site of the Work to extent of ninety percent (90%) of cost thereof, and balance of cost thereof when said balance is paid to Contractor; and
 - 3. Each subcontractor, respective amount allowed Contractor because of work performed by subcontractor to extent of subcontractor's interest therein.

29. CONTRACT SECURITY

- A. Contractor shall furnish Performance and Payment Bonds in amount at least equal to one hundred percent (100%) of Contract price as security for faithful performance of this Contract and payment of all persons performing labor on project under this Contract and furnishing materials in connection with this Contract.
- B. Sample Performance and Payment Bonds that Contractor will be required to execute is bound into these Construction Documents. Before construction Contract is consummated, completed Performance and Payment Bonds must be approved by Department.

30. ASSIGNMENTS

- A. Contractor shall not assign whole or any part of this Contract or any moneys due or to become due hereunder without written consent of Department. In case Contractor assigns all or any part of any moneys due or to become due under this Contract, instrument of

assignment shall contain clause substantially to effect that it is agreed that right of assignee in and to any moneys due or to become due to Contractor shall be subject to prior claims of all persons, firms and corporations for services rendered or materials supplied for performance of the Work called for in this Contract.

31. MUTUAL RESPONSIBILITY OF CONTRACTORS

- A. If, through acts of neglect on part of Contractor or any subcontractor shall suffer loss or damage on the Work, Contractor agrees to settle with such subcontractor by agreement or arbitration if such other subcontractor will so settle. If such subcontractor shall assert any claim against County on account of any damage alleged to have been sustained, Department shall notify Contractor, who shall indemnify, hold harmless and defend Dane County, its boards, commissions, agencies, officers, employees and representatives against any such claim.

32. SEPARATE CONTRACTS

- A. Department may award other contracts for the Work and all Contractors shall fully cooperate with each other and carefully adjust their work to that provided under other contracts as may be directed by Department. No Contractor shall commit or permit any act that will interfere with performance of the Work by any other Contractor.
- B. Contractor shall coordinate the Work with those of other Contractors. Cooperation will be required in arrangement for storage of materials and in detailed execution of the Work. Contractor, including subcontractors, shall keep informed of progress and detail work of others and shall notify Architect / Engineer or Department immediately of lack of progress or defective workmanship on part of others. Failure of Contractor to keep informed of the Work progressing on site and failure to give notice of lack of progress or defective workmanship by others shall be construed as acceptance by Contractor of status of the Work as being satisfactory for proper coordination with Contractor's own work.

33. SUBCONTRACTS

- A. Contractor may use services of specialty subcontractors on those parts of the Work that, under normal contracting practices, are performed by specialty subcontractors.
- B. Contractor shall not award any work to any subcontractor without prior approval of Department. Qualifications of subcontractors shall be same as qualifications of Contractor. Request for subcontractor approval shall be submitted to Department fifteen (15) business days before start of subcontractor's work. If subcontractors are changed or added, Contractor shall notify Department in writing.
- C. Contractor shall be as fully responsible to County for acts and omissions of subcontractors, and of persons either directly or indirectly employed by them, as Contractor is for acts and omissions of persons directly employed by Contractor.
- D. Contractor shall cause appropriate provisions to be inserted in all subcontracts relative to the Work to bind subcontractors to Contractor by terms of General Conditions of Contract and other Construction Documents insofar as applicable to work of subcontractors and to give Contractor same power as regards terminating any subcontract that Department may exercise over Contractor under any provision of Construction Documents.

- E. Nothing contained in this Contract shall create any contractual relation between any subcontractor and County.
- F. Contractor shall insert in all subcontracts, Articles 26, 33, 43 and 45, respectively entitled: “Withholding of Payments”, “Subcontracts”, “Affirmative Action Provision and Minority / Women / Disadvantaged Business Enterprises”, and “Minimum Wages”, and shall further require all subcontractors to incorporate physically these same Articles in all subcontracts.

34. PROJECT MANAGER’S AUTHORITY

- A. Public Works Project Manager shall:
 - 1. Administer and ensure compliance with Construction Documents;
 - 2. Provide responsible on-site observations of construction and have authority to request work and to stop work whenever necessary to insure proper enforcement of Construction Documents;
 - 3. Convene and chair project meetings and foreman’s coordination meetings when necessary to coordinate resolution of conflicts between Contractors, Architects, Engineers, Consultants, and Department; and
 - 4. Check and inspect material, equipment and installation procedures of all trades for proper workmanship and for compliance with Drawings, Specifications and Shop Drawings, permit no material on project site that is not satisfactory and reject work not in compliance with Construction Documents.

35. CONSULTANT’S AUTHORITY

- A. Engineer is retained by, and is responsible to Department acting for County.
- B. Engineer shall determine amount, quality, acceptability, and fitness of several kinds of work and materials that are provided under this Contract and shall decide all questions that may arise in relation to said work and construction thereof.
- C. Engineer shall decide meaning and intent of any portion of Specifications and of any Drawings where they may be found obscure or be in dispute.
- D. Engineer shall provide responsible observation of construction. Architect / Engineer has authority to stop the Work whenever such stoppage may be necessary to insure proper execution of Construction Documents.
- E. Engineer shall be interpreter of conditions of Construction Documents and judge of its performance.
- F. Within reasonable time, Engineer shall make decisions on all matters relating to progress of the Work or interpretation of Construction Documents.
- G. Engineer’s decisions are subject to review by Public Works Project Manager.

36. STATED ALLOWANCES

- A. Stated allowances enumerated in Instructions to Bidders shall cover net cost of materials or equipment, and all applicable taxes. Contractor’s cost of delivery and unloading at site, handling costs on site, labor, installation costs, overhead, profit and any other incidental costs shall be included in Contractor’s bid, but not as part of cash allowance.

- B. Department will solicit at least two (2) bids on materials or equipment for which allowance is stated and select on basis of lowest qualified responsible bid. Contractor will then be instructed to purchase “Allowed Materials”. If actual price for purchasing “Allowed Materials”, including taxes, is more or less than “Cash Allowance”, Contract price shall be adjusted accordingly. Adjustment in Contract price shall not contain any cost items excluded from cash allowance.

37. ESTIMATES OF QUANTITIES

- A. Whenever estimated quantities of work to be done and materials to be furnished under this Contract are shown in any of Construction Documents, they are given for use in comparing bids and right is especially reserved to increase or diminish them as they may be deemed reasonably necessary or desirable by Department to complete the Work included in this Contract, and cost for such increase or diminution shall be adjusted in manner provided for in General Conditions of Contract Article 18 entitled “Changes in the Work”.

38. LANDS AND RIGHTS-OF-WAY

- A. Prior to start of construction, County shall furnish all land and rights-of-way necessary for carrying out and completion of the Work to be performed under this Contract.

39. GENERAL GUARANTEE

- A. Neither final certificate of payment nor any provision in Construction Documents nor partial or entire occupancy of premises by County shall constitute acceptance of work not done in accordance with Construction Documents or relieve Contractor of liability in respect to any expressed warranties or responsibility for faulty materials or workmanship.
 - 1. In no event shall making of any payment required by Contract constitute or be construed as waiver by County of any breach of covenants of Contract or waiver of any default of Contractor and making of any such payment by County while any such default or breach shall exist shall in no way impair or prejudice right of County with respect to recovery of damages or other remedy as result of such breach or default.
- B. Contractor shall remedy and make good all defective workmanship and materials and pay for any damage to other work resulting there from, which appear within period of one (1) year from date of substantial completion, providing such defects are not clearly due to abuse or misuse by County. Department will give notice of observed defects with reasonable promptness.
- C. Guarantee on work executed after certified date of substantial completion will begin on date when such work is inspected and approved by Architect / Engineer and Public Works Project Manager.
- D. Where guarantees or warranties are required in sections of Specifications for periods in excess of one (1) year, such longer terms shall apply; however, Contractor’s Performance and Payment Bonds shall not apply to any guarantee or warranty period in excess of one (1) year.

40. CONFLICTING CONDITIONS

- A. Any provision in any of Construction Documents which may be in conflict or inconsistent with any Articles in these General Conditions of Contract or Supplementary Conditions shall be void to extent of such conflict or inconsistency.
- B. In case of ambiguity or conflict between Drawings and Specifications, Specifications shall govern.
- C. Printed dimensions shall be followed in preference to measurements by scale. Large-scale drawings take precedence over small-scale drawings. Dimensions on Drawings and details are subject to field measurements of adjacent work.

41. NOTICE AND SERVICE THEREOF

- A. Any notice to Contractor from Department relative to any part of this Contract shall be in writing and considered delivered and service thereof completed, when said notice is posted, by certified or registered mail, to Contractor at Contractor's last given address, or delivered in person to said Contractor, or Contractor's authorized representative on the Work.

42. PROTECTION OF LIVES AND HEALTH

- A. In order to protect lives and health of Contractor's employees under Contract, Contractor shall comply with all pertinent provisions of Wisconsin Administrative Code, Rules of Department of Commerce, relating to Safety and Health.
- B. Contractor alone shall be responsible for safety, efficiency and adequacy of Contractor's tools, equipment and methods, and for any damage that may result from their failure or their improper construction, maintenance or operation.

43. AFFIRMATIVE ACTION PROVISION AND MINORITY / WOMEN / DISADVANTAGED BUSINESS ENTERPRISES

- A. Affirmative Action Provisions.
 - 1. During term of their Contract, Contractor agrees not to discriminate on basis of race, religion, color, sex, handicap, age, sexual preference, marital status, physical appearance, or national origin against any person, whether recipient of services (actual or potential), employee, or applicant for employment. Such equal opportunity shall include but not be limited to following: employment, upgrading, demotion, transfer, recruitment, advertising, layoff, termination, training, rates of pay, and any other form of compensation or level of service(s). Contractor agrees to post in conspicuous places, these affirmative action standards so as to be visible to all employees, service recipients and applicants for this paragraph. Listing of prohibited bases for discrimination shall not be construed to amend in any fashion state or federal law setting forth additional bases and exceptions shall be permitted only to extent allowable in state or federal law.
 - 2. Contractor is subject to this Article only if Contractor has ten (10) or more employees and receives \$10,000.00 or more in annual aggregate contracts with County. Contractor shall file and Affirmative Action Plan with Dane County Contract Compliance Officer in accord with Chapter 19 of Dane County Code of Ordinances. Such plan must be filed within fifteen (15) business days of effective date of this Contract and failure to do so by said date shall constitute ground for immediate termination of Contract by County. Contractor shall also, during term of this Contract, provide copies of all announcements

- of employment opportunities to County's Contract Compliance Office, and shall report annually number of persons, by race, sex and handicap status, who apply for employment, and, similarly classified, number hired and number rejected.
3. Contact Dane County Contract Compliance Officer at Dane County Contract Compliance Office, 210 Martin Luther King, Jr. Blvd., Room 421, Madison, WI 53703, 608/266-4114.
 4. In all solicitations for employment placed on Contractor's behalf during term of this Contract, Contractor shall include statement to affect Contractor is "Equal Opportunity Employer". Contractor agrees to furnish all information and reports required by County's Contract Compliance Officer as same relate to affirmative action and nondiscrimination, which may include any books, records, or accounts deemed appropriate to determine compliance with Chapter 19, Dane County Code of Ordinances, and provision of this Contract.
- B. Minority / Women / Disadvantaged / Emerging Small Business Enterprises.
1. Chapter 19.508 of Dane County Code of Ordinances is official policy of Dane County regarding utilization of, to fullest extent of, Minority Business Enterprises (MBEs), Women Business Enterprises (WBEs) Disadvantage Business Enterprises (DBEs) and Emerging Small Business Enterprises (ESBEs).
 2. Contractor may utilize MBEs / WBEs / DBEs / ESBEs as subcontractors or suppliers. List of subcontractors will be required of low bidder as stated in this Contract. List shall indicate which are MBEs / WBEs / DBEs / ESBEs and percentage of subcontract awarded, shown as percentage of total dollar amount of bid.

44. COMPLIANCE WITH FAIR LABOR STANDARDS

- A. During term of this Contract, Contractor shall report to County Contract Compliance Officer, within ten (10) business days, any allegations to, or findings by National Labor Relations Board (NLRB) or Wisconsin Employment Relations Commission (WERC) that Contractor has violated statute or regulation regarding labor standards or relations. If investigation by Contract Compliance Officer results in final determination that matter adversely affects Contractor's responsibilities under this Contract, and which recommends termination, suspension or cancellation of this Contract, County may take such action.
- B. Contractor may appeal any adverse finding by Contract Compliance Officer as set forth in Dane County Ordinance 25.015(11)(c) through (e).
- C. Contractor shall post this statement in prominent place visible to employees: "As condition of receiving and maintaining contract with Dane County, this employer shall comply with federal, state and all other applicable laws prohibiting retaliation or union organizing."

45. DOMESTIC PARTNERSHIP BENEFITS

- A. Not Used.

46. USE AND OCCUPANCY PRIOR TO ACCEPTANCE

- A. Contractor agrees to use and occupancy of portion or unit of the Work before formal acceptance by Department, provided Department:
 1. Secures written consent of Contractor; except when in opinion of Public Works Project Manager, Contractor is chargeable with unwarranted delay in final cleanup of punch list items or other Contract requirements.

2. Secures endorsement from insurance carrier and consent of Surety permitting occupancy of building or use of the Work during remaining period of construction, or, secures consent of Surety.
3. Assumes all costs and maintenance of heat, electricity and water.
4. Accepts all work completed within that portion or unit of the Work to be occupied, at time of occupancy.

47. MINIMUM WAGES

- A. Contractor shall post, at appropriate conspicuous point on site of project, schedule showing all determined minimum wage rates for various classes of laborers and mechanics to be engaged in the Work under this Contract and all deductions, if any, required by law to be made from unpaid wages actually earned by laborers and mechanics so engaged.
- B. Supplementary Conditions section in Construction Documents lists wage determinations required by State Law.
- C. If, after award of Contract, it becomes necessary to employ any person in trade or occupation not classified in wage determinations, such person shall be paid at not less than such rate as shall be determined by Wisconsin Department of Workforce Development. Such approved minimum rate shall be retroactive to time of initial employment of such person in such trade or occupation. Contractor shall notify Department of Contractor's intention to employ persons in trades or occupations not so classified in sufficient time for Department to obtain approved rates for such trades or occupations.
- D. Specified wage rates are minimum rates only, and Department will not consider any claims for additional compensation made by Contractor because of payment by Contractor of any wage rate in excess of applicable rate contained in this Contract. Contractor shall adjust any disputes in regard to payment of wages in excess of those specified in this Contract.

48. CLAIMS

- A. No claim may be made until Department's [Deputy Public Works Director has reviewed Engineer's decision as provided for in Article 35 of General Conditions of Contract. If any claim remains unresolved after such review by Department's Deputy Public Works, Waste & Renewables] Director the claim may be filed under Wisconsin Statute 893.80. Work shall progress during period of any dispute or claim. Unless specifically agreed between parties, venue will be in Dane County, Wisconsin.

49. ANTITRUST AGREEMENT

- A. Contractor and County recognize that in actual economic practice, overcharges resulting from antitrust violations are in fact usually borne by County. Therefore, Contractor hereby assigns to County any and all claims for such overcharges as to goods and materials purchased in connection with this Contract, except as to overcharges which result from antitrust violations commencing after price is established under this Contract and any change order thereto.

50. INSURANCE

- A. Contractor Carried Insurance:
 1. Contractor shall not commence work under this Contract until Contractor has obtained all insurance required under this Article and has provided evidence of such insurance to Risk

Manager, 425 City-County Building, 210 Martin Luther King Jr. Blvd., Madison, WI 53703. Contractor shall not allow any subcontractor to commence work until insurance required of subcontractor has been so obtained and approved. Company providing insurance must be licensed to do business in Wisconsin.

2. Worker's Compensation Insurance:
 - a) Contractor shall procure and shall maintain during life of this Contract, Worker's Compensation Insurance as required by statute for all of Contractor's employees engaged in work at site of project under this Contract and, in case of any such work sublet, Contractor shall require subcontractor similarly to provide Worker's Compensation Insurance for all of latter's employees to be engaged in such work unless such employees are covered by protection afforded by Contractor's Worker's Compensation Insurance.
 - b) If any claim of employees engaged in hazardous work on project under this Contract is not protected under Worker's Compensation Statute, Contractor shall provide and shall cause each subcontractor to provide adequate Employer's Liability Insurance for protection of such of Contractor's employees as are not otherwise protected.
3. Contractor's Public Liability and Property Damage Insurance:
 - a) Contractor shall procure and maintain during life of this Contract, Contractor's Public Liability Insurance and Contractor's Property Damage Insurance in amount not less than \$1,000,000 bodily injury, including accidental death, to any one person, and subject to same limit for each person, in amount not less than \$1,000,000 on account of one accident, and Contractor's Property Damage Insurance in amount not less than \$1,000,000 or combined single limit of at least \$1,000,000 with excess coverage over and above general liability in amount not less than \$5,000,000. Contractor shall add "Dane County" as additional insured for each project.
 - b) Contractor's Public Liability and Property Damage Insurance shall include Products, Completed Operation, and Contractual Liability under Insurance Contract. "Contractor shall in all instances save, defend, indemnify and hold harmless County and Architect / Engineer against all claims, demands, liabilities, damages or any other costs which may accrue in prosecution of the Work and that Contractor will save, defend, indemnify and hold harmless County and Architect / Engineer from all damages caused by or as result of Contractor's operations" and each shall be listed as additional insured on Contractor's and subcontractors' insurance policies.
 - c) Obligations of Contractor under Article 50.A.2.b) shall not extend to liability of Architect / Engineer, agents or employees thereof, arising out of:
 - 1) Preparation or approval of maps, drawings, opinions, reports, surveys, change orders, designs or specifications; or
 - 2) Giving of or failure to give directions or instructions by Architect / Engineer, agents or employees thereof provided such giving or failure to give is primary cause of injury or damage.
 - d) Contractor shall procure and shall maintain during life of this Contract, Comprehensive Automobile Liability Insurance covering owned, non-owned and hired automobiles for limits of not less than \$1,000,000 each accident single limit, bodily injury and property damage combined with excess coverage over and above general liability in amount not less than \$5,000,000.
 - e) Contractor shall either:
 - 1) Require each subcontractor to procure and to maintain during life of subcontract, subcontractor's Public Liability Property Damage Insurance, and Comprehensive Automobile Liability Insurance of type and in same amount specified in preceding paragraphs; or
 - 2) Insure activities of subcontractors in Contractor's own policy.
4. Scope of Insurance and Special Hazards: Insurance required under Article 50.A.2 & 50.A.3. hereof shall provide adequate protection for Contractor and subcontractors, respectively, against damage claims which may arise from operations under this Contract,

whether such operation be by insured or by anyone directly or indirectly employed by insured and also against any of special hazards which may be encountered in performance of this Contract as enumerated in Supplementary Conditions.

5. Proof of Carriage of Insurance: Contractor shall furnish Risk Manager with certificates showing type, amount, class of operations covered, effective dates, dates of expiration of policies and "Dane County" listed as additional insured. Such certificates shall also contain (substantially) following statement: "Insurance covered by this certificate will not be canceled or materially altered, except after ten (10) business days written notice has been received by Risk Manager."

B. Builder's Risk:

1. County shall provide Builder's Risk insurance coverage for its insurable interests in construction or renovation projects with completed value of \$1,000,000 or less. Therefore, if project completed value is more than \$1,000,000, Contractor shall obtain and maintain in force, at its own expense, Builder's Risk Insurance on all risks for amount equal to full completed value of covered structure or replacement value of alterations or additions. Any deductible shall not exceed \$25,000 for each loss. Policy shall include occupancy clause and list Dane County as loss payee.

C. Indemnification / Hold Harmless:

1. Contractor shall indemnify, hold harmless and defend Dane County, its boards, commissions, agencies, officers, employees and representatives from and against all claims, damages, losses and expenses including attorneys' fees arising out of or resulting from performance of the Work, provided that any such claim, damage, loss or expense is attributable to bodily injury, sickness, disease or death, or to injury to or destruction of tangible property (other than the Work itself) including loss of use resulting therefrom, and is caused in whole or in part by any act or omission of Contractor, any subcontractor, anyone directly or indirectly employed by any of them or anyone for whose acts any of them may be liable, regardless of whether or not it is caused in part by part indemnified hereunder.
2. In any and all claims against Dane County, its boards, commissions, agencies, officers, employees and representatives or by any employee of Contractor, any subcontractor, anyone directly or indirectly employed by any of them or anyone for whose acts any of them may be liable, indemnification obligation under this Contract shall not be limited in any way by any limitation on amount or type of damages, compensation or benefits payable by or for Contractor or any subcontractor under worker's compensation acts, disability benefits or other employee benefit acts.
3. Obligations of Contractor under this Contract shall not extend to liability of Architect / Engineer, its agents or employees arising out of:
 - a) Preparation or approval of maps, drawings, opinion, reports, surveys, change orders, designs or specifications; or
 - b) Giving of or failure to give directions or instruction by Architect / Engineer, its agents or employees provided such giving or failure to give is primary cause of injury or damage.
4. Dane County shall not be liable to Contractor for damages or delays resulting from work by third parties or by injunctions or other restraining orders obtained by third parties.

51. WISCONSIN LAW CONTROLLING

- A. It is expressly understood and agreed to by parties hereto that in event of any disagreement or controversy between parties, Wisconsin law shall be controlling.

END OF SECTION

SECTION 00 73 00

SUPPLEMENTARY CONDITIONS

1. APPLICATION & CERTIFICATE FOR PAYMENT

- A. Every contractor engaged in performance of any contract for Department of [Public Works, Highway & Transportation, Waste & Renewables] shall submit partial and final Application & Certificate for Payment for work under said contract. Form shall provide similar information as shown on AIA G702™ and G703™ forms (samples shown below). Forms shall be submitted to Public Works Project Manager for approval.



AIA Document G702™ – 1992

Application and Certificate for Payment

TO OWNER:	PROJECT:	APPLICATION NO:	Distribution to:
		PERIOD TO:	OWNER <input type="checkbox"/>
FROM CONTRACTOR:	VIA ARCHITECT:	CONTRACT FOR:	ARCHITECT <input type="checkbox"/>
		CONTRACT DATE:	CONTRACTOR <input type="checkbox"/>
		PROJECT NOS:	FIELD <input type="checkbox"/>
			OTHER <input type="checkbox"/>

CONTRACTOR'S APPLICATION FOR PAYMENT

Application is made for payment, as shown below, in connection with the Contract. AIA Document G703™, Continuation Sheet, is attached.

1. ORIGINAL CONTRACT SUM \$ _____

2. NET CHANGE BY CHANGE ORDERS \$ _____

3. CONTRACT SUM TO DATE (Line 1 + 2) \$ _____

4. TOTAL COMPLETED & STORED TO DATE (Column G on G703) \$ _____

5. RETAINAGE:

a. _____% of Completed Work
(Columns D + E on G703) \$ _____

b. _____% of Stored Material
(Column F on G703) \$ _____

Total Retainage (Lines 5a + 5b, or Total in Column I of G703) \$ _____

6. TOTAL EARNED LESS RETAINAGE \$ _____
(Line 4 minus Line 5 Total)

7. LESS PREVIOUS CERTIFICATES FOR PAYMENT \$ _____
(Line 6 from prior Certificate)

8. CURRENT PAYMENT DUE \$ _____

9. BALANCE TO FINISH, INCLUDING RETAINAGE \$ _____
(Line 3 minus Line 6)

CHANGE ORDER SUMMARY	ADDITIONS	DEDUCTIONS
Total changes approved in previous months by Owner	\$	\$
Total approved this month	\$	\$
TOTAL	\$	\$
NET CHANGES by Change Order	\$	\$

The undersigned Contractor certifies that to the best of the Contractor's knowledge, information and belief the Work covered by this Application for Payment has been completed in accordance with the Contract Documents, that all amounts have been paid by the Contractor for Work for which previous Certificates for Payment were issued and payments received from the Owner, and that current payment shown herein is now due.

CONTRACTOR:
By: _____ Date: _____
State of: _____
County of: _____
Subscribed and sworn to before me this _____ day of _____

Notary Public:
My commission expires: _____

ARCHITECT'S CERTIFICATE FOR PAYMENT

In accordance with the Contract Documents, based on on-site observations and the data comprising this application, the Architect certifies to the Owner that to the best of the Architect's knowledge, information and belief the Work has progressed as indicated, the quality of the Work is in accordance with the Contract Documents, and the Contractor is entitled to payment of the AMOUNT CERTIFIED.

AMOUNT CERTIFIED \$ _____
(Attach explanation if amount certified differs from the amount applied. Initial all figures on this Application and on the Continuation Sheet that are changed to conform with the amount certified.)

ARCHITECT:
By: _____ Date: _____

This Certificate is not negotiable. The AMOUNT CERTIFIED is payable only to the Contractor named herein. Issuance, payment and acceptance of payment are without prejudice to any rights of the Owner or Contractor under this Contract.

CAUTION: You should sign an original AIA Contract Document, on which this text appears in RED. An original assures that changes will not be obscured.

AIA Document G702™ – 1992, Copyright © 1963, 1965, 1971, 1978, 1983 and 1992 by The American Institute of Architects. All rights reserved. WARNING: This AIA® Document is protected by U.S. Copyright Law and International Treaties. Unauthorized reproduction or distribution of this AIA® Document, or any portion of it, may result in severe civil and criminal penalties, and will be prosecuted to the maximum extent possible under the law. Purchasers are permitted to reproduce ten (10) copies of this document when completed. To report copyright violations of AIA Contract Documents, e-mail The American Institute of Architects' legal counsel, copyright@aia.org. 0107140204

 **AIA** Document G703™ – 1992

Continuation Sheet

AIA Document G702™-1992, Application and Certificate for Payment, or G732™-2009, Application and Certificate for Payment, Construction Manager as Adviser Edition, containing Contractor's signed certification is attached. In tabulations below, amounts are in US dollars. Use Column I on Contracts where variable retainage for line items may apply.

APPLICATION NO:
APPLICATION DATE:
PERIOD TO:
ARCHITECT'S PROJECT NO:

A ITEM NO.	B DESCRIPTION OF WORK	C SCHEDULED VALUE	D WORK COMPLETED		F MATERIALS PRESENTLY STORED <i>(Not in D or E)</i>	G TOTAL COMPLETED AND STORED TO DATE <i>(D+E+F)</i>	H BALANCE TO FINISH <i>(C-G)</i>	I RETAINAGE <i>(if variable rate)</i>
			FROM PREVIOUS APPLICATION <i>(D + E)</i>	THIS PERIOD				
GRAND TOTAL								

CAUTION: You should sign an original AIA Contract Document, on which this text appears in RED. An original assures that changes will not be obscured.

AIA Document G703™ – 1992. Copyright © 1963, 1965, 1966, 1967, 1970, 1978, 1983 and 1992 by The American Institute of Architects. All rights reserved. WARNING: This AIA® Document is protected by U.S. Copyright Law and International Treaties. Unauthorized reproduction or distribution of this AIA® Document, or any portion of it, may result in severe civil and criminal penalties, and will be prosecuted to the maximum extent possible under the law. Purchasers are permitted to reproduce ten (10) copies of this document when completed. To report copyright violations of AIA Contract Documents, e-mail The American Institute of Architects' legal counsel, copyright@aia.org. 10-12-04044

SUBMITTAL

SAMPLE ONLY -
NOT FOR
SUBMITTAL



Department of Public Works, Highway & Transportation
Public Works Engineering Division

608/266-4018

Gerald J. Mandli, P.E.
Commissioner / Director

Joseph T. Parisi
County Executive

Deputy Director
Todd Draper

1919 Alliant Energy Center Way
Madison, Wisconsin 53713
Fax: 608/267-1533
www.countyofdane.com/pwht/public_works.aspx

BEST VALUE CONTRACTING APPLICATION

CONTRACTORS / LICENSURE APPLICANTS

The Dane County Department of Public Works requires all contractors & subcontractors to be a best value contractor before being hired. Application documents are due to the County prior to Bid Due Date. Approval or rejection shall be within five (5) days of Bid Due Date. This document shall be completed, properly executed, along with the necessary attachments and additional information that the County requires for the protection and welfare of the public in the performance of a County contract.

Contractors or subcontractors of any tier who attain qualification status will retain that status for a period of two (2) years from the date of qualification. Contractors shall notify the Dane County Department of Public Works, Highway & Transportation within fifteen (15) days of any changes to its business or operations that are relevant to the application. Failure to do so could result in suspension, revocation of the contractor's qualification, debarment from County contracts for up to three (3) years and / or other sanctions available under the law.

No contracts will be awarded for construction work performed on Dane County projects unless the contractor is currently approved as a Wisconsin Trade Trainer or has applied for approval as an Apprenticeship Trade Trainer to the Wisconsin Department of Workforce Development and agrees to an acceptable apprenticeship program. If you are not currently approved as a Wisconsin Trade Trainer, or have not applied for approval as an Apprenticeship Trade Trainer, please contact the Department of Workforce Development - Bureau of Apprenticeship Standards at 608/266-3133 or visit their web site at: <https://dwd.wisconsin.gov/apprenticeship/>.

EXEMPTIONS

- Contractors who employ less than five (5) apprenticeable trade workers are not required to qualify.
- Contractors performing work that does not apply to an apprenticeable trade, as outlined in Appendix A.
- The contractor / subcontractor provides sufficient documentation to demonstrate one or more of the following:
 - apprentices are not available in a specific geographic area;
 - the applicable apprenticeship program is unsuitable or unavailable; or
 - there is a documented depression of the local construction market which prevents compliance.

SEC.	PROOF OF RESPONSIBILITY	CHECK IF APPLICABLE
1	Does your firm possess all technical qualifications and resources, including equipment, personnel and financial resources, necessary to perform the work required for any project or obtain the same through the use of responsible, qualified subcontractors?	Yes: <input type="checkbox"/> No: <input type="checkbox"/>
2	Will your firm possess all valid, effective licenses, registrations or certificates required by federal, state, county, or local law, which are necessary for the type of work to be performed including, but not limited to, those for any type of trade work or specialty work?	Yes: <input type="checkbox"/> No: <input type="checkbox"/>
3	Will your firm meet all bonding requirements as required by applicable law or contract specifications?	Yes: <input type="checkbox"/> No: <input type="checkbox"/>
4	Will your firm meet all insurance requirements as required by applicable law or specifications, including general liability insurance, workers compensation insurance and unemployment insurance requirements?	Yes: <input type="checkbox"/> No: <input type="checkbox"/>
5	Will your firm maintain a substance abuse policy for employees hired for public works contracts that comply with Wis. Stats. Sec. 103.503?	Yes: <input type="checkbox"/> No: <input type="checkbox"/>
6	Will your firm fully abide by the equal opportunity and affirmative action requirements of all applicable laws, including County ordinances?	Yes: <input type="checkbox"/> No: <input type="checkbox"/>
7	In the past three (3) years, has your firm had control or has another corporation, partnership or other business entity operating in the construction industry controlled it? If so, please attach a statement explaining the nature of the firm relationship?	Yes: <input type="checkbox"/> No: <input type="checkbox"/> If Yes, attach details.
8	In the past three (3) years, has your firm had any type of business, contracting or trade license, certification or registration revoked or suspended?	Yes: <input type="checkbox"/> No: <input type="checkbox"/> If Yes, attach details.
9	In the past three (3) years, has your firm been debarred by any federal, state or local government agency?	Yes: <input type="checkbox"/> No: <input type="checkbox"/> If Yes, attach details.
10	In the past three (3) years, has your firm defaulted or failed to complete any contract?	Yes: <input type="checkbox"/> No: <input type="checkbox"/> If Yes, attach details.
11	In the past three (3) years, has your firm committed a willful violation of federal, state or local government safety laws as determined by a final decision of a court or government agency authority.	Yes: <input type="checkbox"/> No: <input type="checkbox"/> If Yes, attach details.
12	In the past three (3) years, has your firm been in violation of any law relating to your contracting business where the penalty for such violation resulted in the imposition of a penalty greater than \$10,000?	Yes: <input type="checkbox"/> No: <input type="checkbox"/> If Yes, attach details.
13	Is your firm an active Wisconsin Trade Trainer as determined by the Wisconsin Bureau of Apprenticeship Standards?	Yes: <input type="checkbox"/> No: <input type="checkbox"/>
14	Is your firm exempt from being qualified with Dane County?	Yes: <input type="checkbox"/> No: <input type="checkbox"/> If Yes, attach reason for exemption.
15	Does your firm acknowledge that in doing work under any County Public Works Contract, it will be required to use as subcontractors only those contractors that are also qualified with the County or become so within five (5) days after the Bid Due Date?	Yes: <input type="checkbox"/> No: <input type="checkbox"/>
16	Contractor has been in business less than one year?	Yes: <input type="checkbox"/> No: <input type="checkbox"/>
17	Is your firm a first time Contractor requesting a one time exemption, but, intend to comply on all future contracts and are taking steps typical of a "good faith" effort?	Yes: <input type="checkbox"/> No: <input type="checkbox"/>

SIGNATURE SECTION

Your firm's Officer, or the individual who would sign a bid and / or contract documents must sign this document.

I do hereby certify that all statements herein contained are true and correct to the best of my knowledge:

Signature: _____

(Application is invalid without signature)

Print Name: _____ Date: _____

Title: _____

NAME AND ADDRESS OF CONTRACTOR	
Name of Firm:	
Address:	
City, State, Zip:	
Phone Number:	
Fax Number:	
E-mail Address:	

REMEMBER!

RETURN ALL TO FORMS AND ATTACHMENTS, OR QUESTIONS TO:

**TODD DRAPER
EMAIL: DRAPER@COUNTYOFDANE.COM
OFFICE: (608) 267-0119, FAX: (608) 267-1533**

**DANE COUNTY DEPARTMENT OF PUBLIC WORKS, HIGHWAY & TRANSPORTATION
1919 ALLIANT ENERGY CENTER WAY
MADISON, WI 53713**

APPENDIX A

APPRENTICEABLE TRADES:

- Bricklayer
- Carpenter
- Cement Mason (Concrete Finisher)
- Cement Mason (Heavy Highway)
- Construction Craft Laborer
- Data Communications Installer
- Electrician
- Elevator Mechanic / Technician
- Environmental Systems Technician / HVAC Service Technician / HVAC Install & Service
- Glazier
- Heavy Equipment Operator / Operating Engineer
- Insulation Worker (Heat & Frost)
- Iron Worker (Assembler, Metal Buildings)
- Painter / Decorator
- Plasterer
- Plumber
- Roofer / Waterproofer
- Sheet Metal Worker
- Sprinkler Fitter
- Steamfitter (Service & Refrigeration)
- Taper & Finisher
- Telecommunications (Voice, Data & Video) Installer / Technician
- Tile Setter

END OF SECTION

SECTION 00 73 11

FAIR LABOR PRACTICES CERTIFICATION

The undersigned, for and on behalf of the BIDDER, APPLICANT or PROPOSER named herein, certifies as follows:

A. That he or she is an officer or duly authorized agent of the above-referenced BIDDER, APPLICANT or PROPOSER, which has a submitted a bid, application or proposal for a contract or agreement with the county of Dane.

B. That BIDDER, APPLICANT or PROPOSER has (check one):

_____ not been found by the National Labor Relations Board (“NLRB”) or the Wisconsin Employment Relations Commission (“WERC”) to have violated any statute or regulation regarding labor standards or relations in the seven years prior to the signature date of this Certification.

_____ been found by the National Labor Relations Board (“NLRB”) or the Wisconsin Employment Relations Commission (“WERC”) to have violated any statute or regulation regarding labor standards or relations in the seven years prior to the signature date of this Certification.

Officer or Authorized Agent Signature

Date

Printed or Typed Name and Title

Printed or Typed Business Name

NOTE: You can find information regarding the violations described above at: www.nlr.gov and werc.wi.gov.

For reference, Dane County Ordinance 25.09 is as follows:

(1) BIDDER RESPONSIBILITY. (a) Any bid, application or proposal for any contract with the county, including public works contracts regulated under chapter 40, shall include a certification indicating whether the bidder has been found by the National Labor Relations Board (NLRB) or the Wisconsin Employment Relations Committee (WERC) to have violated any statute or regulation regarding labor standards or relations within the last seven years. The Controller shall investigate any such finding and make a recommendation to the committee, which shall determine whether the conduct resulting in the finding affects the bidder’s responsibility to perform the contract.

If you indicated that the NLRB or WERC have found you to have such a violation, you must include copies of any relevant information regarding such violation with your proposal, bid or application.

Include this completed Certification with your bid, application or proposal.

END OF SECTION

SECTION 01 00 00
GENERAL REQUIREMENTS

PART 1 GENERAL

1.1 SUMMARY

- A. Section Includes:
1. Summary
 2. Summary of the Work
 3. Contractor Use of Premises
 4. Applications for Payment
 5. Change Procedures
 6. Alternates
 7. Lump Sum Allowances for Work
 8. Coordination
 9. Cutting and Patching
 10. Conferences
 11. Progress Meetings
 12. Job Site Administration
 13. Submittal Procedures
 14. Proposed Products List
 15. Shop Drawings
 16. Product Data
 17. Samples
 18. Manufacturers' Instructions
 19. Manufacturers' Certificates
 20. Quality Assurance / Quality Control of Installation
 21. References
 22. Interior Enclosures
 23. Protection of Installed Work
 24. Parking
 25. Staging Areas
 26. Occupancy During Construction and Conduct of Work
 27. Protection
 28. Progress Cleaning
 29. Products
 30. Transportation, Handling, Storage and Protection
 31. Product Options
 32. Substitutions
 33. Starting Systems
 34. Demonstration and Instructions
 35. Contract Closeout Procedures
 36. Final Cleaning
 37. Adjusting
 38. Operation and Maintenance Data

- 39. Spare Parts and Maintenance Materials
- 40. As-Built and Record Drawings and Specifications

1.2 SUMMARY OF THE WORK

- A. Project Description: Perform the Work as specified and detailed in Construction Documents package.
- B. Work by Owner:
 - 1. Site prep, grading and placement of aggregate base for shelters
 - 2. Furnish & install project signage.
- C. Permits: Prior to commencement of the Work, Contractor to secure any and all necessary permits for completion of the Work and facility occupancy. Provide Public Works Project Manager with copies of all permits.
- D. Diggers Hotline:
 - 1. It is General Contractor's responsibility to contact Diggers Hotline to have all utility locations marked prior to excavation and planning excavation so as not to delay the Work.
 - 2. Diggers Hotline shall also be used to obtain information on safe working clearances from overhead lines.
 - 3. Completely comply with all requirements of each affected utility company.
 - 4. It is General Contractor's responsibility to contact & hire private utility locating services if necessary.

1.3 CONTRACTOR USE OF PREMISES

- A. Limit use of premises to allow work by others and work by Owner.
- B. Coordinate utility outages and shutdowns with Owner.

1.4 APPLICATIONS FOR PAYMENT

- A. Submit one (1) original copies with "wet" signatures of each application on AIA G702™ and G703™ forms or approved contractors invoice form.
- B. Content and Format: Utilize Schedule of Values for listing items in Application for Payment.
- C. Payment Period: Monthly.
- D. Submit Applications for Payment to Public Works Project Manager for approval & processing for payment.

1.5 CHANGE PROCEDURES

- A. Contractor's costs for Products, delivery, installation, labor, insurance, payroll, taxes, bonding, equipment rental, overhead and profit will be included in Change Orders authorizing expenditure of funds from contingency allowance.
- B. Change Order Forms: Dane County Contract Change Order, Form 014-32-20 (latest issue)

1.6 ALTERNATES

- A. Alternates quoted on Bid Form shall be reviewed and accepted or rejected at Owner's option.
- B. Coordinate related work and modify surrounding work as required.
- C. Schedule of Alternates: there are no alternates proposed for this project.

1.7 LUMP SUM ALLOWANCES FOR WORK

- A. Not Applicable.

1.8 COORDINATION

- A. Coordinate scheduling, submittals, and work of various sections of Specifications to assure efficient and orderly sequence of installation of interdependent construction elements.
- B. Verify utility requirement characteristics of operating equipment are compatible with building utilities.
- C. Coordinate space requirements and installation of mechanical and electrical work that are indicated diagrammatically on Drawings.
- D. Contractor shall provide Public Works Project Manager with work plan that ensures the Work will be completed within required time of completion.
- E. Public Works Project Manager may choose to photograph or videotape site or workers as the Work progresses.

1.9 CUTTING AND PATCHING

- A. Employ skilled and experienced installer to perform cutting and patching new work; restore work with new Products.
- B. Submit written request in advance of cutting or altering structural or building enclosure elements.

- C. Fit work tight to adjacent elements. Maintain integrity of wall, ceiling, or floor construction; completely seal voids.
- D. Refinish surfaces to match adjacent finishes.

1.10 CONFERENCES

- A. Project shall have pre-bid conference; see Instructions to Bidders.
- B. Owner will schedule preconstruction conference after Award of Contract for all affected parties.
- C. Contractor shall submit Construction Schedule at pre-construction meeting.
- D. When required in individual Specification section, convene pre-installation conference at project site prior to commencing work of Section.

1.11 PROGRESS MEETINGS

- A. Schedule and administer meetings throughout progress of the Work at minimum of one (1) per week, at time to be determined by Public Works Project Manager.
- B. Preside at meetings, record minutes, and distribute copies within two (2) business days to those affected by decisions made.
- C. Attendance at progress meetings by General Contractor, subcontractors, or their authorized representative, is mandatory.
- D. Contractors shall give verbal reports of progress on the Work, discuss schedule for upcoming period and present all conflicts, discrepancies or other difficulties for resolution.
- E. Day & time of progress meetings to be determined at pre-construction meeting.

1.12 JOB SITE ADMINISTRATION

- A. Contractor shall have project superintendent on site minimum of four (4) hours per day during progress of the Work.
- B. Contractor shall not change their project superintendent or project manager for duration of the Work without written permission of Public Works Project Manager.
- C. Engineer shall have representative on site regularly, during progress of the Work.

1.13 SUBMITTAL PROCEDURES

- A. Submittal form to identify Project, Contractor, Subcontractor or supplier; and pertinent Construction Documents references.

- B. Apply Contractor's stamp, signed or initialed, certifying that review, verification of Products required, field dimensions, adjacent construction work, and coordination of information is in accordance with requirements of the Work and Construction Documents.
- C. Identify variations from Construction Documents and Product or system limitations that may be detrimental to successful performance of completing the Work.
- D. Revise and resubmit submittals as required; identify all changes made since previous submittal.

1.14 PROPOSED PRODUCTS LIST

- A. Within fifteen (15) business days after date of Award of Contract, submit complete list of major Products proposed for use, with name of manufacturer, trade name, and model number of each Product.

1.15 SHOP DRAWINGS

- A. Submit number of copies that Contractor requires, plus three (3) copies that shall be retained by Public Works Project Manager.

1.16 PRODUCT DATA

- A. Submit number of copies that Contractor requires, plus two (2) copies that shall be retained by Public Works Project Manager.
- B. Mark each copy to identify applicable products, models, options, and other data. Supplement manufacturer's standard data to provide information unique to this Project.

1.17 SAMPLES

- A. Submit samples to illustrate functional and aesthetic characteristics of Product.
- B. Submit samples of finishes from full range of manufacturers' standard colors, textures, and patterns for Public Works Project Manager's selection.

1.18 MANUFACTURERS' INSTRUCTIONS

- A. When specified in individual Specification sections, submit manufacturers' printed instructions for delivery, storage, assembly, installation, start-up, adjusting, and finishing, in quantities specified for Product Data.

1.19 MANUFACTURERS' CERTIFICATES

- A. When specified in individual Specification sections, submit manufacturers' certificate to Public Works Project Manager for review, in quantities specified for Product Data.

- B. Indicate material or Product conforms to or exceeds specified requirements. Submit supporting reference data, affidavits, and certifications as appropriate.

1.20 QUALITY ASSURANCE / QUALITY CONTROL OF INSTALLATION

- A. Monitor quality control over suppliers, manufacturers, Products, services, site conditions, and workmanship, to produce work of specified quality.
- B. Comply fully with manufacturers' instructions.
- C. Comply with specified standards as minimum quality for the Work except when more stringent tolerances, codes, or specified requirements indicate higher standards or more precise workmanship.

1.21 REFERENCES

- A. Conform to reference standard by date of issue current as of date for receiving bids.
- B. Should specified reference standard conflict with Construction Documents, request clarification from [Public Works, Waste & Renewables] Project Manager before proceeding.

1.22 INTERIOR ENCLOSURES

- A. Provide temporary partitions as required to separate work areas from Owner occupied areas, to prevent distribution of dust and moisture into Owner occupied areas, and to prevent damage to existing materials and equipment.

1.23 PROTECTION OF INSTALLED WORK

- A. Protect installed work and provide special protection where specified in individual Specification sections.

1.24 PARKING

- A. Arrange for temporary parking areas to accommodate construction personnel. [Parking shall be available at the Work site.
- B. All contractors and their employees shall cooperate with General Contractor and others in parking of vehicles to avoid interference with normal operations and construction activities.
- C. Do not obstruct existing service drives and parking lots with equipment, materials and / or vehicles. Keep accessible for Owner's use at all times.

1.25 STAGING AREAS

- A. Coordinate staging areas with Public Works Project Manager prior to starting the Work.

- B. On-site space for use as staging areas and storage of materials is limited and will be apportioned among various Contractors as their needs dictate with due regard for storage requirements of each Contractor. Each Contractor shall be responsible for safety of equipment and materials that are stored on site.

1.26 OCCUPANCY DURING CONSTRUCTION AND CONDUCT OF WORK

- A. All construction material and salvage material shall be removed from facility or secured at day's end.
- B. Contractors are asked to not work at facility if they are ill with something contagious.
- C. Smoking is prohibited on Dane County property.
- D. Owner reserves right at any time to dismiss from premises any Contractor or construction personnel that do not uphold requirements of this Section.
- E. Owner shall not be held liable for any lost time, wages, or impacts to construction schedule by any Contractor or construction personnel dismissed for failure to uphold requirements of this Section.
- F. Areas of existing facility will be occupied during period when the Work is in progress. Work may be done during normal business hours (7:00 am to 7:00 pm), but confer with Owner, schedule work and store materials so as to interfere as little as possible with normal use of premises. Work performed on Saturday shall be by permission of Owner. Notify Owner when coring or similar noise making work is to be done and obtain Owner's written approval of schedule. If schedule is not convenient for Owner, reschedule and resubmit new times for Owner approval.
- G. Work shall be done so as not to interfere with access to any occupied area and so as to cause least possible interference with normal operation of facility or any essential service thereof.
- H. Contractor shall, at all times, provide approved, safe walkways and facility entrances for use by Owner, employees and public.
- I. Contractor shall provide adequate protection for all parts of facility, its contents and occupants wherever the Work under this Contract is to be performed.
- J. Each Contractor shall arrange with Owner to make necessary alterations, do new work, make connections to all utilities, etc., and at such times as will not cause interruption of utility services to facility. Contractor doing this work shall protect, cap, cut off and / or replace and relocate existing pipes, electrical work and other active utilities encountered which may interfere with new construction work.
- K. New work in extension of existing work shall correspond in all respects with that to which it connects or similar existing work unless otherwise indicated or specified.
 - 1. Existing work shall be cut, altered, removed or replaced as necessary for performance of Contract obligations.

2. Work remaining in place, damaged or defaced by reason of work done under this Contract shall be restored equal to its condition at time of Award of Contract.
3. If removal of work exposes discolored or unfinished surfaces or work out of alignment, such surfaces shall be refinished or materials replaced as necessary to make continuous work uniform and harmonious.

L. Contractor is not responsible for providing & maintaining temporary toilet facilities.

1.27 PROTECTION

- A. Contractor shall protect from damage / injury all trees, shrubs, hedges, plantings, grass, mechanical, electrical & plumbing equipment, walks and driveways and pay for any damage to same resulting from insufficient or improper protection.
- B. Contractor shall provide and maintain barricades & signage to prohibit public access to construction site.

1.28 PROGRESS CLEANING

- A. Maintain areas free of waste materials, debris, and rubbish. Maintain site in clean and orderly condition.

1.29 PRODUCTS

- A. Products: Means new material, machinery, components, equipment, fixtures, and systems forming the Work, but does not include machinery and equipment used for preparation, fabrication, conveying and erection of the Work. Products may also include existing materials or components specifically identified for reuse.
- B. Do not use materials and equipment removed from existing premises, except as specifically identified or allowed by Construction Documents.

1.30 TRANSPORTATION, HANDLING, STORAGE AND PROTECTION

- A. Transport, handle, store and protect Products in accordance with manufacturer's instructions.

1.31 PRODUCT OPTIONS

- A. Where definite material is specified, it is not intentional to discriminate against "equal" product made by another manufacturer. Intention is to set definite standard of material quality. Should bidder choose to bid materials other than those specified, bidder shall submit said materials specifications to Public Works Project Manager for approval at least seven (7) business days prior to Bid Due Date.
- B. Products and materials that are not specified, but have been approved for use by Public Works Project Manager shall be identified in addenda to all bidding contractors.

- C. Requests for material or product substitutions submitted after Bid Due Date may be considered. Owner reserves right to approve or reject substitutions based on Specification requirements and intended use.

1.32 SUBSTITUTIONS

- A. Public Works Project Manager shall consider requests for Substitutions only within fifteen (15) calendar days after date of Public Works Construction Contract.
- B. Document each request with complete data substantiating compliance of proposed Substitution with Construction Documents.
- C. Submit three (3) copies of requests for Substitution for consideration. Limit each request to one (1) proposed Substitution.
- D. Substitutions shall not change contract price established at Bid Due Date.

1.33 STARTING SYSTEMS

- A. Provide written notification prior to start-up of each equipment item or system.
- B. Ensure that each piece of equipment or system is ready for operation.
- C. Execute start-up under supervision of responsible persons in accordance with manufacturers' instructions.
- D. Submit written report that equipment or system has been properly installed and is functioning correctly.

1.34 DEMONSTRATION AND INSTRUCTIONS

- A. Demonstrate operation and maintenance of Products to Owner's personnel prior to date of final inspection.
- B. Demonstrate start-up, operation, control, adjustment, trouble-shooting, servicing, maintenance, and shutdown of each item of equipment at agreed-upon times, at designated location.
- C. Owner may choose to photograph or videotape demonstration session; demonstration and demonstrator shall be to level of satisfaction of Owner.

1.35 CONTRACT CLOSEOUT PROCEDURES

- A. Submit written certification that Construction Documents have been reviewed, the Work has been inspected, and the Work is complete in accordance with Construction Documents and ready for Public Works Project Manager's inspection.
- B. Submit final Application for Payment identifying total adjusted Contract Sum / Price, previous payments, and amount remaining due.

1.36 FINAL CLEANING

- A. Execute final cleaning prior to final inspection.
- B. Clean interior and exterior surfaces exposed to view.
- C. Remove waste and surplus materials, rubbish, and construction facilities from site.

1.37 ADJUSTING

- A. Adjust operating Products and equipment to ensure smooth and unhindered operation.

1.38 OPERATION AND MAINTENANCE MANUAL

- A. Provide two (2) bound, hard-copy operation and maintenance manuals that include all systems, materials, products, equipment, mechanical and electrical equipment and systems supplied and installed in the Work. Provide electronic version of operation and maintenance manual also.

1.39 SPARE PARTS AND MAINTENANCE MATERIALS

- A. Provide Products, spare parts, maintenance and extra materials in quantities specified in individual Specification Sections.
- B. Deliver to the Work site and place in location as directed.

1.40 AS-BUILT AND RECORD DRAWINGS AND SPECIFICATIONS

- A. Contractor-produced Drawings and Specifications shall remain property of Contractor whether Project for which they are made is executed or not. Contractor shall furnish , Engineer with original marked up redlines of Construction Documents' drawings and specifications that shall include all Addendums, Change Orders, Construction Bulletins, on-site changes, field corrections, etc. These are project As-Built Drawings & Specifications
- B. Engineer shall update original Construction Documents to include all Addendums & any other changes including those provided by Contractor in As-Built Drawings & Specifications. These updates are project Record Drawings & Specifications.
- C. Engineer shall furnish Public Works Project Manager with Record Drawings as detailed in Professional Services Agreement.

PART 2 PRODUCTS

Not Used.

PART 3 EXECUTION

Not Used.

END OF SECTION

SECTION 01 74 19

CONSTRUCTION WASTE MANAGEMENT, DISPOSAL & RECYCLING

PART 1 GENERAL

1.1 SUMMARY

- A. Section Includes:
 - 1. Summary
 - 2. Waste Management Goals
 - 3. Construction and / or Demolition Waste Management
 - 4. Waste Management Plan
 - 5. Reuse
 - 6. Recycling
 - 7. Materials Sorting and Storage On Site
 - 8. Lists of Recycling Facilities Processors and Haulers
 - 9. Waste Management Plan Form
- B. Related Sections:
 - 1. Section 01 00 00 - General Requirements

1.2 WASTE MANAGEMENT GOALS

- A. Dane County requires that as many waste materials as possible produced as result of this project be salvaged, reused or recycled in order to minimize impact of construction waste on landfills and to minimize expenditure of energy and cost in fabricating new materials. Additional information may be found in Dane County Green Building Policy, Resolution 299, 1999-2000.

1.3 CONSTRUCTION AND / OR DEMOLITION WASTE MANAGEMENT

- A. All construction and demolition waste suitable for recycling may go to Dane County Construction & Demolition Recycling Facility located at 7102 US Hwy 12, Madison, located across from Yahara Hills Golf Course. This facility can receive mixed loads of construction and demolition waste. For complete list of acceptable materials see www.countyofdane.com/pwht/recycle/CD_Recycle.aspx.
- B. Dane County Landfill, also at 7102 US Hwy 12, Madison, must receive all other waste from this project. www.countyofdane.com/pwht/recycle/landfill.aspx.

1.4 WASTE MANAGEMENT PLAN

- A. Contractor shall develop Waste Management Plan (WMP) for this project. Dane County's Special Projects & Materials Manager may be contacted with questions. Outlined in RECYCLING section of this specification are examples of materials that can be recycled or reused as well as recommendations for waste sorting methods.
- B. Contractor shall complete WMP and include cost of recycling / reuse in Bid. WMP will be submitted to Public Works Project Manager within fifteen (15)

business days of Bid Due date. Copy of blank WMP form is in this Section. Submittal shall include cover letter and WMP form with:

1. Information on:
 - a. Types of waste materials produced as result of work performed on site;
 - b. Estimated quantities of waste produced;
 - c. Identification of materials with potential to be recycled or reused;
 - d. How materials will be recycled or reused;
 - e. On-site storage and separation requirements (on site containers);
 - f. Transportation methods; and
 - g. Destinations.

1.5 REUSE

- A. Contractors and subcontractors are encouraged to reuse as many waste materials as possible. Salvage should be investigated for materials not reusable on site.

1.6 RECYCLING

- A. These materials may be recycled at Dane County Construction & Demolition Recycling Facility:
 1. Wood.
 2. Wood Pallets.
 3. PVC Plastic (pipe, siding, etc.).
 4. Asphalt & Concrete.
 5. Bricks & Masonry.
 6. Vinyl Siding.
 7. Cardboard.
 8. Metal.
 9. Unpainted Gypsum Drywall.
 10. Shingles.
- B. These materials can be recycled elsewhere in Dane County area:
 1. Fluorescent Lamps.
 2. Foam Insulation & Packaging (extruded and expanded).
 3. Carpet Padding.
 4. Barrels & Drums.
- C. All materials must be recycled at WDNR permitted waste processing facilities that adhere to all State Statutes.

1.7 MATERIALS SORTING AND STORAGE ON SITE

- A. Contractor shall provide separate containers for recyclable materials. Number of containers will be dependent upon project and site conditions.
- B. Contractor shall provide on-site locations for subcontractors supplied recycling containers to help facilitate recycling.
- C. Mixed loads of recycled materials are allowed only per instructions at www.countyofdane.com/pwht/recycle/CD_Recycle.aspx.

1.8 LISTS OF RECYCLING FACILITIES PROCESSORS AND HAULERS

- A. Refer to www.countyofdane.com/pwht/recycle/CD_Recycle.aspx for information on Dane County Construction & Demolition Recycling Facility.
- B. Web site www.countyofdane.com/pwht/recycle/categories.aspx lists current information for Dane County Recycling Markets. Contractors can also contact Allison Rathsack at 608/266-4990, or local city, village, town recycling staff listed at site www.countyofdane.com/pwht/recycle/contacts.aspx. Statewide listings of recycling / reuse markets are available from UW Extension at <https://www.uwgb.edu/shwec/>.

PART 2 PRODUCTS

Not Used.

PART 3 EXECUTION

Not Used.

END OF SECTION

WASTE MANAGEMENT PLAN FORM



Contractor Name: _____

Address: _____

Phone No.: _____ Recycling Coordinator: _____

MATERIAL	ESTIMATED QUANTITY	DISPOSAL METHOD (CHECK ONE)	RECYCLING / REUSE COMPANY OR DISPOSAL SITE
Salvaged & reused building materials	_____ cu. yds. _____ tons	____ Recycled ____ Reused ____ Landfilled ____ Other	Name: _____
Wood	_____ cu. yds. _____ tons	____ Recycled ____ Reused ____ Landfilled ____ Other	Name: _____
Wood Pallets	_____ units	____ Recycled ____ Reused ____ Landfilled ____ Other	Name: _____
PVC Plastic	_____ cu. ft. _____ lbs.	____ Recycled ____ Reused ____ Landfilled ____ Other	Name: _____
Asphalt & Concrete	_____ cu. ft. _____ lbs.	____ Recycled ____ Reused ____ Landfilled ____ Other	Name: _____
Bricks & Masonry	_____ cu. ft. _____ lbs.	____ Recycled ____ Reused ____ Landfilled ____ Other	Name: _____
Vinyl Siding	_____ cu. ft. _____ lbs.	____ Recycled ____ Reused ____ Landfilled ____ Other	Name: _____
Cardboard	_____ cu. ft. _____ lbs.	____ Recycled ____ Reused ____ Landfilled ____ Other	Name: _____
Metals	_____ cu. yds. _____ tons	____ Recycled ____ Reused ____ Landfilled ____ Other	Name: _____
Unpainted Gypsum / Drywall	_____ cu. yds. _____ tons	____ Recycled ____ Reused ____ Landfilled ____ Other	Name: _____
Shingles	_____ cu. yds. _____ tons	____ Recycled ____ Reused ____ Landfilled ____ Other	Name: _____
Fluorescent Lamps	_____ cu. ft. _____ lbs.	____ Recycled ____ Reused ____ Landfilled ____ Other	Name: _____
Foam Insulation	_____ cu. ft. _____ lbs.	____ Recycled ____ Reused ____ Landfilled ____ Other	Name: _____
Carpet Padding	_____ cu. ft. _____ lbs.	____ Recycled ____ Reused ____ Landfilled ____ Other	Name: _____
Barrels & Drums	_____ units	____ Recycled ____ Reused ____ Landfilled ____ Other	Name: _____
Glass	_____ cu. yds. _____ tons	____ Recycled ____ Reused ____ Landfilled ____ Other	Name: _____

WASTE MANAGEMENT PLAN FORM

Other	_____	<input type="checkbox"/> Recycled <input type="checkbox"/> Reused <input type="checkbox"/> Landfilled <input type="checkbox"/> Other	Name: _____
Other	_____	<input type="checkbox"/> Recycled <input type="checkbox"/> Reused <input type="checkbox"/> Landfilled <input type="checkbox"/> Other	Name: _____
Other	_____	<input type="checkbox"/> Recycled <input type="checkbox"/> Reused <input type="checkbox"/> Landfilled <input type="checkbox"/> Other	Name: _____
Other	_____	<input type="checkbox"/> Recycled <input type="checkbox"/> Reused <input type="checkbox"/> Landfilled <input type="checkbox"/> Other	Name: _____
Other	_____	<input type="checkbox"/> Recycled <input type="checkbox"/> Reused <input type="checkbox"/> Landfilled <input type="checkbox"/> Other	Name: _____

SECTION 03 20 00

CONCRETE REINFORCING

PART 1 - GENERAL

1.1 SUMMARY

A. Section Includes:

1. Steel reinforcement bars.
2. Welded-wire reinforcement.

1.2 ACTION SUBMITTALS

A. Product Data: For the following:

1. Each type of steel reinforcement.

B. Shop Drawings: Comply with ACI SP-066:

1. Include placing drawings that detail fabrication, bending, and placement.
2. Include bar sizes, lengths, materials, grades, bar schedules, stirrup spacing, bent bar diagrams, bar arrangement, location of splices, lengths of lap splices, details of mechanical splice couplers, details of welding splices, tie spacing, hoop spacing, and supports for concrete reinforcement.

1.3 INFORMATIONAL SUBMITTALS

A. Welding certificates.

1. Reinforcement to Be Welded: Welding procedure specification in accordance with AWS D1.4/D1.4M

B. Material Test Reports: For the following, from a qualified testing agency:

1. Steel Reinforcement:
 - a. For reinforcement to be welded, mill test analysis for chemical composition and carbon equivalent of the steel in accordance with ASTM A706/A706M.
2. Mechanical splice couplers.

C. Field quality-control reports.

1.4 QUALITY ASSURANCE

- A. Welding Qualifications: Qualify procedures and personnel in accordance with AWS D1.4/D 1.4M.

PART 2 - PRODUCTS

2.1 STEEL REINFORCEMENT

- A. Reinforcing Bars: ASTM A615/A615M, **Grade 60 (Grade 420)**, deformed.

2.2 REINFORCEMENT ACCESSORIES

- A. Bar Supports: Bolsters, chairs, spacers, and other devices for spacing, supporting, and fastening reinforcing bars and welded-wire reinforcement in place.

2.3 FABRICATING REINFORCEMENT

- A. Fabricate steel reinforcement according to CRSI's "Manual of Standard Practice."

PART 3 - EXECUTION

3.1 PREPARATION

- A. Clean reinforcement of loose rust and mill scale, earth, ice, and other foreign materials that reduce bond to concrete.

3.2 INSTALLATION OF STEEL REINFORCEMENT

- A. Comply with CRSI's "Manual of Standard Practice" for placing and supporting reinforcement.
- B. Accurately position, support, and secure reinforcement against displacement.
 - 1. Locate and support reinforcement with bar supports to maintain minimum concrete cover.
 - 2. Do not tack weld crossing reinforcing bars.
- C. Preserve clearance between bars of not less than **1 inch (25 mm)**, not less than one bar diameter, or not less than 1-1/3 times size of large aggregate, whichever is greater.
- D. Provide concrete coverage in accordance with **ACI 318 (ACI 318M)**.
- E. Set wire ties with ends directed into concrete, not toward exposed concrete surfaces.

3.3 INSTALLATION TOLERANCES

- A. Comply with ACI 117 (ACI 117M).

3.4 FIELD QUALITY CONTROL

- A. Special Inspections: Owner will engage a special inspector to perform field tests and inspections and prepare test reports.
- B. Testing Agency: Engage a qualified testing and inspecting agency to perform tests and inspections and to submit reports.
- C. Inspections:
 - 1. Steel-reinforcement placement.

END OF SECTION 032000

SECTION 03 30 00

CAST-IN-PLACE CONCRETE

PART 1 - GENERAL

1.1 SUMMARY

A. Section Includes:

1. Cast-in-place concrete, including concrete materials, mixture design, placement procedures, and finishes.

1.2 DEFINITIONS

- A. Cementitious Materials: Portland cement alone or in combination with one or more of the following: blended hydraulic cement, fly ash, slag cement, and other pozzolans materials subject to compliance with requirements.
- B. Water/Cement Ratio (w/cm): The ratio by weight of water to cementitious materials.

1.3 ACTION SUBMITTALS

A. Product Data: For each of the following.

1. Portland cement.
2. Fly ash.
3. Slag cement.
4. Blended hydraulic cement.
5. Aggregates.
6. Admixtures:
 - a. Include limitations of use, including restrictions on cementitious materials, supplementary cementitious materials, air entrainment, aggregates, temperature at time of concrete placement, relative humidity at time of concrete placement, curing conditions, and use of other admixtures.
7. Vapor retarders.
8. Liquid floor treatments.
9. Curing materials.
10. Joint fillers.

B. Design Mixtures: For each concrete mixture, include the following:

1. Mixture identification.
2. Minimum 28-day compressive strength.
3. Durability exposure class.
4. Maximum w/cm.
5. Calculated equilibrium unit weight, for lightweight concrete.

6. Slump limit.
7. Air content.
8. Nominal maximum aggregate size.
9. Indicate amounts of mixing water to be withheld for later addition at Project site if permitted.
10. Intended placement method.
11. Submit alternate design mixtures when characteristics of materials, Project conditions, weather, test results, or other circumstances warrant adjustments.

C. Shop Drawings:

1. Construction Joint Layout: Indicate proposed construction joints required to construct the structure.
 - a. Location of construction joints is subject to approval of the Architect.

1.4 INFORMATIONAL SUBMITTALS

A. Material Certificates: For each of the following, signed by manufacturers:

1. Cementitious materials.
2. Admixtures.
3. Curing compounds.

B. Material Test Reports: For the following, from a qualified testing agency:

1. Portland cement.
2. Fly ash.
3. Slag cement.
4. Blended hydraulic cement.
5. Aggregates.
6. Admixtures:

C. Research Reports: For concrete admixtures in accordance with ICC's Acceptance Criteria AC198.

D. Preconstruction Test Reports: For each mix design.

E. Field quality-control reports.

1.5 QUALITY ASSURANCE

A. Ready-Mixed Concrete Manufacturer Qualifications: A firm experienced in manufacturing ready-mixed concrete products and that complies with ASTM C94/C94M requirements for production facilities and equipment.

1. Manufacturer certified in accordance with NRMCA's "Certification of Ready Mixed Concrete Production Facilities."

1.6 DELIVERY, STORAGE, AND HANDLING

- A. Comply with ASTM C94/C94M and **ACI 301 (ACI 301M)**.

1.7 FIELD CONDITIONS

- A. Cold-Weather Placement: Comply with **ACI 301 (ACI 301M)** and ACI 306.1.
- B. Hot-Weather Placement: Comply with **ACI 301 (ACI 301M)** and **ACI 305.1 (ACI 305.1M)**.

PART 2 - PRODUCTS

2.1 CONCRETE, GENERAL

- A. ACI Publications: Comply with **ACI 301 (ACI 301M)** unless modified by requirements in the Contract Documents.

2.2 CONCRETE MATERIALS

- A. Cementitious Materials: as noted on drawings.
- B. Normal-Weight Aggregates: ASTM C33/C33M, Class 3M coarse aggregate or better, graded. Provide aggregates from a single source.
 - 1. Maximum Coarse-Aggregate Size: **3/4 inch (19 mm)** nominal.
 - 2. Fine Aggregate: Free of materials with deleterious reactivity to alkali in cement.
- C. Air-Entraining Admixture: ASTM C260/C260M.
- D. Chemical Admixtures: Certified by manufacturer to be compatible with other admixtures that do not contribute water-soluble chloride ions exceeding those permitted in hardened concrete. Do not use calcium chloride or admixtures containing calcium chloride in steel-reinforced concrete.
 - 1. Water-Reducing Admixture: ASTM C494/C494M, Type A.
 - 2. Retarding Admixture: ASTM C494/C494M, Type B.
 - 3. Water-Reducing and -Retarding Admixture: ASTM C494/C494M, Type D.
 - 4. High-Range, Water-Reducing Admixture: ASTM C494/C494M, Type F.
 - 5. High-Range, Water-Reducing and -Retarding Admixture: ASTM C494/C494M, Type G.
 - 6. Plasticizing and Retarding Admixture: ASTM C1017/C1017M, Type II.
- E. Water and Water Used to Make Ice: ASTM C94/C94M, potable or complying with ASTM C1602/C1602M, including all limits listed in Table 2 and the requirements of paragraph 5.4.

2.3 CURING MATERIALS

- A. Absorptive Cover: AASHTO M 182, Class 2, burlap cloth made from jute or kenaf, weighing approximately 9 oz./sq. yd. (305 g/sq. m) when dry.
- B. Water: Potable or complying with ASTM C1602/C1602M.

2.4 CONCRETE MIXTURES, GENERAL

- A. Prepare design mixtures for each type and strength of concrete, proportioned on the basis of laboratory trial mixture or field test data, or both, in accordance with ACI 301 (ACI 301M).
 - 1. Use a qualified testing agency for preparing and reporting proposed mixture designs, based on laboratory trial mixtures.
- B. Cementitious Materials: Limit percentage, by weight, of cementitious materials other than portland cement in concrete as follows:
 - 1. Fly Ash or Other Pozzolans: 25 percent by mass.
 - 2. Slag Cement: 50 percent by mass.
 - 3. Total of Fly Ash or Other Pozzolans, Slag Cement: 50 percent by mass, with fly ash or pozzolans not exceeding 25 percent by mass.
 - 4. Total of Fly Ash or Other Pozzolans: 35 percent by mass with fly ash or pozzolans not exceeding 25 percent by mass.
- C. Admixtures: Use admixtures in accordance with manufacturer's written instructions.
 - 1. Use water-reducing high-range water-reducing or plasticizing admixture in concrete, as required, for placement and workability.
 - 2. Use water-reducing and -retarding admixture when required by high temperatures, low humidity, or other adverse placement conditions.

2.5 CONCRETE MIXTURES

- A. Normal-weight concrete used for footings as indicated in drawings.

2.6 CONCRETE MIXING

- A. Ready-Mixed Concrete: Measure, batch, mix, and deliver concrete in accordance with ASTM C94/C94M and ASTM C1116/C1116M, and furnish batch ticket information.

PART 3 - EXECUTION

3.1 INSTALLATION OF EMBEDDED ITEMS

- A. Place and secure anchorage devices and other embedded items required for adjoining Work that is attached to or supported by cast-in-place concrete.
 - 1. Use setting drawings, templates, diagrams, instructions, and directions furnished with items to be embedded.
 - 2. Install anchor rods, accurately located, to elevations required and complying with tolerances in Section 7.5 of ANSI/AISC 303.
 - 3. Install reglets to receive waterproofing and to receive through-wall flashings in outer face of concrete frame at exterior walls, where flashing is shown at lintels, shelf angles, and other conditions.

3.2 CONCRETE PLACEMENT

- A. Before placing concrete, verify that installation of formwork, reinforcement, embedded items, and vapor retarder is complete and that required inspections are completed.
 - 1. Immediately prior to concrete placement, inspect vapor retarder for damage and deficient installation, and repair defective areas.
 - 2. Provide continuous inspection of vapor retarder during concrete placement and make necessary repairs to damaged areas as Work progresses.
- B. Notify testing and inspection agencies 24 hours prior to commencement of concrete placement.
- C. Do not add water to concrete during delivery, at Project site, or during placement unless approved by Architect in writing, but not to exceed the amount indicated on the concrete delivery ticket.
 - 1. Do not add water to concrete after adding high-range water-reducing admixtures to mixture.
- D. Before test sampling and placing concrete, water may be added at Project site, subject to limitations of **ACI 301 (ACI 301M)**, but not to exceed the amount indicated on the concrete delivery ticket.
 - 1. Do not add water to concrete after adding high-range water-reducing admixtures to mixture.
- E. Deposit concrete continuously in one layer or in horizontal layers of such thickness that no new concrete is placed on concrete that has hardened enough to cause seams or planes of weakness.
 - 1. If a section cannot be placed continuously, provide construction joints as indicated.
 - 2. Deposit concrete to avoid segregation.
 - 3. Deposit concrete in horizontal layers of depth not to exceed formwork design pressures and in a manner to avoid inclined construction joints.

4. Consolidate placed concrete with mechanical vibrating equipment in accordance with **ACI 301 (ACI 301M)**.
 - a. Do not use vibrators to transport concrete inside forms.
 - b. Insert and withdraw vibrators vertically at uniformly spaced locations to rapidly penetrate placed layer and at least **6 inches (150 mm)** into preceding layer.
 - c. Do not insert vibrators into lower layers of concrete that have begun to lose plasticity.
 - d. At each insertion, limit duration of vibration to time necessary to consolidate concrete, and complete embedment of reinforcement and other embedded items without causing mixture constituents to segregate.

3.3 FINISHING FORMED SURFACES

A. As-Cast Surface Finishes:

1. **ACI 301 (ACI 301M)** Surface Finish SF-1.0: As-cast concrete texture imparted by form-facing material.
 - a. Patch voids larger than **1-1/2 inches (38 mm)** wide or **1/2 inch (13 mm)** deep.
 - b. Remove projections larger than **1 inch (25 mm)**.
 - c. Tie holes do not require patching.
 - d. Surface Tolerance: **ACI 117 (ACI 117M)** Class D.
 - e. Apply to concrete surfaces not exposed to public view.

3.4 INSTALLATION OF MISCELLANEOUS CONCRETE ITEMS

A. Filling In:

1. Fill in holes and openings left in concrete structures after Work of other trades is in place unless otherwise indicated.
2. Mix, place, and cure concrete, as specified, to blend with in-place construction.
3. Provide other miscellaneous concrete filling indicated or required to complete the Work.

- #### B. Curbs: Provide monolithic finish to interior curbs by stripping forms while concrete is still green and by steel-troweling surfaces to a hard, dense finish with corners, intersections, and terminations slightly rounded.

3.5 CONCRETE CURING

A. Protect freshly placed concrete from premature drying and excessive cold or hot temperatures.

1. Comply with **ACI 301 (ACI 301M)** and ACI 306.1 for cold weather protection during curing.
2. Comply with **ACI 301 (ACI 301M)** and **ACI 305.1 (ACI 305.1M)** for hot-weather protection during curing.
3. Maintain moisture loss no more than **0.2 lb/sq. ft. x h (1 kg/sq. m x h)**, calculated in accordance with **ACI 305.1**.) before and during finishing operations.

B. Curing Formed Surfaces: Comply with **ACI 308.1 (ACI 308.1M)** as follows:

1. Cure formed concrete surfaces, including underside of beams, supported slabs, and other similar surfaces.
2. Cure concrete containing color pigments in accordance with color pigment manufacturer's instructions.
3. If forms remain during curing period, moist cure after loosening forms.
4. If removing forms before end of curing period, continue curing for remainder of curing period, as follows:
 - a. Continuous Fogging: Maintain standing water on concrete surface until final setting of concrete.
 - b. Continuous Sprinkling: Maintain concrete surface continuously wet.
 - c. Absorptive Cover: Pre-dampen absorptive material before application; apply additional water to absorptive material to maintain concrete surface continuously wet.
 - d. Water-Retention Sheeting Materials: Cover exposed concrete surfaces with sheeting material, taping, or lapping seams.
 - e. Membrane-Forming Curing Compound: Apply uniformly in continuous operation by power spray or roller in accordance with manufacturer's written instructions.
 - 1) Recoat areas subject to heavy rainfall within three hours after initial application.
 - 2) Maintain continuity of coating and repair damage during curing period.

3.6 TOLERANCES

A. Conform to **ACI 117 (ACI 117M)**.

3.7 FIELD QUALITY CONTROL

- A. Special Inspections: Owner will engage a special inspector to perform field tests and inspections and prepare testing and inspection reports.
- B. Testing Agency: Owner will engage a qualified testing and inspecting agency to perform tests and inspections and to submit reports.
 1. Testing agency shall be responsible for providing curing container for composite samples on Site and verifying that field-cured composite samples are cured in accordance with ASTM C31/C31M.
 2. Testing agency shall immediately report to Architect, Contractor, and concrete manufacturer any failure of Work to comply with Contract Documents.
 3. Testing agency shall report results of tests and inspections, in writing, to Owner, Architect, Contractor, and concrete manufacturer within 48 hours of inspections and tests.
 - a. Test reports shall include reporting requirements of ASTM C31/C31M, ASTM C39/C39M, and ACI 301, including the following as applicable to each test and inspection:

- 1) Project name.
 - 2) Name of testing agency.
 - 3) Names and certification numbers of field and laboratory technicians performing inspections and testing.
 - 4) Name of concrete manufacturer.
 - 5) Date and time of inspection, sampling, and field testing.
 - 6) Date and time of concrete placement.
 - 7) Location in Work of concrete represented by samples.
 - 8) Date and time sample was obtained.
 - 9) Truck and batch ticket numbers.
 - 10) Design compressive strength at 28 days.
 - 11) Concrete mixture designation, proportions, and materials.
 - 12) Field test results.
 - 13) Information on storage and curing of samples before testing, including curing method and maximum and minimum temperatures during initial curing period.
 - 14) Type of fracture and compressive break strengths at seven days and 28 days.
- C. Batch Tickets: For each load delivered, submit three copies of batch delivery ticket to testing agency, indicating quantity, mix identification, admixtures, design strength, aggregate size, design air content, design slump at time of batching, and amount of water that can be added at Project site.
- D. Inspections:
1. Headed bolts and studs.
 2. Verification of use of required design mixture.
 3. Concrete placement, including conveying and depositing.
 4. Curing procedures and maintenance of curing temperature.
 5. Verification of concrete strength before removal of shores and forms from beams and slabs.
 6. Batch Plant Inspections: On a random basis, as determined by Architect.
- E. Concrete Tests: Testing of composite samples of fresh concrete obtained in accordance with ASTM C 172/C 172M shall be performed in accordance with the following requirements:
1. Testing Frequency: Obtain one composite sample for each day's pour of each concrete mixture exceeding 5 cu. yd. (4 cu. m), but less than 25 cu. yd. (19 cu. m), plus one set for each additional 50 cu. yd. (38 cu. m) or fraction thereof.
 - a. When frequency of testing provides fewer than five compressive-strength tests for each concrete mixture, testing shall be conducted from at least five randomly selected batches or from each batch if fewer than five are used.
 2. Slump: ASTM C143/C143M:
 - a. One test at point of placement for each composite sample, but not less than one test for each day's pour of each concrete mixture.
 - b. Perform additional tests when concrete consistency appears to change.

3. Slump Flow: ASTM C1611/C1611M:
 - a. One test at point of placement for each composite sample, but not less than one test for each day's pour of each concrete mixture.
 - b. Perform additional tests when concrete consistency appears to change.
4. Air Content: ASTM C231/C231M pressure method, for normal-weight concrete.
 - a. One test for each composite sample, but not less than one test for each day's pour of each concrete mixture.
5. Concrete Temperature: ASTM C1064/C1064M:
 - a. One test hourly when air temperature is 40 deg F (4.4 deg C) and below or 80 deg F (27 deg C) and above, and one test for each composite sample.
6. Unit Weight: ASTM C567/C567M fresh unit weight of structural lightweight concrete.
 - a. One test for each composite sample, but not less than one test for each day's pour of each concrete mixture.
7. Compression Test Specimens: ASTM C31/C31M:
 - a. Cast and laboratory cure two sets of four 6-inch (150 mm) by 12-inch (300 mm) or 4-inch (100 mm) by 8-inch (200 mm) cylinder specimens for each composite sample.
 - b. Cast, initial cure, and field cure two sets of four standard cylinder specimens for each composite sample.
8. Compressive-Strength Tests: ASTM C39/C39M.
 - a. Test one set of four laboratory-cured specimens at seven days and one set of two specimens at 28 days.
 - b. Test one set of four field-cured specimens at seven days and one set of two specimens at 28 days.
 - c. A compressive-strength test shall be the average compressive strength from a set of two specimens obtained from same composite sample and tested at age indicated.
9. When strength of field-cured cylinders is less than 85 percent of companion laboratory-cured cylinders, Contractor shall evaluate operations and provide corrective procedures for protecting and curing in-place concrete.
10. Strength of each concrete mixture will be satisfactory if every average of any three consecutive compressive-strength tests equals or exceeds specified compressive strength, and no compressive-strength test value falls below specified compressive strength by more than 500 psi (3.4 MPa) if specified compressive strength is 5000 psi (34.5 MPa), or no compressive strength test value is less than 10 percent of specified compressive strength if specified compressive strength is greater than 5000 psi (34.5 MPa).
11. Nondestructive Testing: Impact hammer, sonoscope, or other nondestructive device may be permitted by Architect but will not be used as sole basis for approval or rejection of concrete.
12. Additional Tests:

- a. Testing and inspecting agency shall make additional tests of concrete when test results indicate that slump, air entrainment, compressive strengths, or other requirements have not been met, as directed by Architect.
 - b. Testing and inspecting agency may conduct tests to determine adequacy of concrete by cored cylinders complying with ASTM C42/C42M or by other methods as directed by Architect.
 - 1) Acceptance criteria for concrete strength shall be in accordance with **ACI 301 (ACI 301M)**, section 1.6.6.3.
13. Additional testing and inspecting, at Contractor's expense, will be performed to determine compliance of replaced or additional work with specified requirements.
 14. Correct deficiencies in the Work that test reports and inspections indicate do not comply with the Contract Documents.

3.8 PROTECTION

A. Protect concrete surfaces as follows:

1. Protect from petroleum stains.
2. Diaper hydraulic equipment used over concrete surfaces.
3. Prohibit vehicles from interior concrete slabs.
4. Prohibit use of pipe-cutting machinery over concrete surfaces.
5. Prohibit placement of steel items on concrete surfaces.
6. Prohibit use of acids or acidic detergents over concrete surfaces.
7. Protect liquid floor treatment from damage and wear during the remainder of construction period. Use protective methods and materials, including temporary covering, recommended in writing by liquid floor treatments installer.
8. Protect concrete surfaces scheduled to receive surface hardener or polished concrete finish using Floor Slab Protective Covering.

END OF SECTION 033000

SECTION 05 12 00

STRUCTURAL STEEL FRAMING

PART 1 - GENERAL

1.1 SUMMARY

- A. Section Includes:
 - 1. Structural steel.
 - 2. Shrinkage-resistant grout.

1.2 DEFINITIONS

- A. Structural Steel: Elements of the structural frame indicated on Drawings and as described in ANSI/AISC 303.

1.3 ACTION SUBMITTALS

- A. Product Data:
 - 1. Structural-steel materials.
 - 2. High-strength, bolt-nut-washer assemblies.
 - 3. Anchor rods.
 - 4. Shrinkage-resistant grout.
- B. Shop Drawings: Show fabrication of structural-steel components.

1.4 INFORMATIONAL SUBMITTALS

- A. Welding certificates.
- B. Mill test reports for structural-steel materials, including chemical and physical properties.
- C. Source quality-control reports.
- D. Field quality-control reports.

1.5 QUALITY ASSURANCE

- A. Fabricator Qualifications: A qualified fabricator that participates in the AISC Quality Certification Program and is designated an AISC-Certified Plant, Category BU or is accredited by the IAS Fabricator Inspection Program for Structural Steel (Acceptance Criteria 172).

- B. Installer Qualifications: A qualified Installer who participates in the AISC Quality Certification Program and is designated an AISC-Certified Erector, or have experience with similar type projects.
- C. Welding Qualifications: Qualify procedures and personnel in accordance with AWS D1.1/D1.1M.

PART 2 - PRODUCTS

2.1 PERFORMANCE REQUIREMENTS

- A. Comply with applicable provisions of the following specifications and documents:
 - 1. ANSI/AISC 303.
 - 2. ANSI/AISC 360.
 - 3. RSSC's "Specifications for Structural Joints Using High-Strength Bolts."

2.2 STRUCTURAL-STEEL MATERIALS

- A. Plates and Bars: **ASTM A588**.
- B. W-Shapes, Angles, Channels and Miscellaneous Channels: **ASTM A588**.
- C. Cold-Formed Hollow Structural Sections: **ASTM A847** structural tubing.
- D. Rods: **ASTM A36**.
- E. Welding Electrodes: Comply with AWS requirements.

2.3 BOLTS AND CONNECTORS

- A. High-Strength A325 Bolts, Nuts, and Washers: ASTM F3125/F3125M, **Grade A325 (Grade A325M)**, Type 3, heavy-hex steel structural bolts; **ASTM A563, Grade DH (ASTM A563M, Class 10S)**, heavy-hex carbon-steel nuts; and ASTM F436/F436M, Type 3, hardened carbon-steel washers.
 - 1. Finish: Plain

2.4 RODS

- A. Threaded Rods: ASTM A36/A36M.
 - 1. Finish: Plain

2.5 SHRINKAGE-RESISTANT GROUT

- A. Metallic, Shrinkage-Resistant Grout: ASTM C1107/C1107M, factory-packed, metallic aggregate grout, mixed with water to consistency suitable for application and a 30-minute working time.
- B. Nonmetallic, Shrinkage-Resistant Grout: ASTM C1107/C1107M, factory-packed, nonmetallic aggregate grout, noncorrosive and nonstaining, mixed with water to consistency suitable for application and a 30-minute working time

2.6 FABRICATION

- A. Structural Steel: Fabricate and assemble in shop to greatest extent possible. Fabricate in accordance with ANSI/AISC 303 and to ANSI/AISC 360.

2.7 SHOP CONNECTIONS

- A. Weld Connections: Comply with AWS D1.1/D1.1M for tolerances, appearances, welding procedure specifications, weld quality, and methods used in correcting welding work.

2.8 SOURCE QUALITY CONTROL

- A. Testing Agency: Engage a qualified testing agency to perform shop tests and inspections.
 - 1. Prepare test and inspection reports.

PART 3 - EXECUTION

3.1 EXAMINATION

- A. Verify, with certified steel erector present, elevations of concrete- and masonry-bearing surfaces and locations of anchor rods, bearing plates, and other embedments for compliance with requirements.
- B. Proceed with installation only after unsatisfactory conditions have been corrected.

3.2 ERECTION

- A. Set structural steel accurately in locations and to elevations indicated and in accordance with ANSI/AISC 303 and ANSI/AISC 360.
- B. Baseplates Bearing Plate: Clean concrete- and masonry-bearing surfaces of bond-reducing materials, and roughen surfaces prior to setting plates. Clean bottom surface of plates.
 - 1. Set plates for structural members on wedges, shims, or setting nuts as required.
 - 2. Weld plate washers to top of baseplate.

3. Snug-tighten anchor rods after supported members have been positioned and plumbed. Do not remove wedges or shims but, if protruding, cut off flush with edge of plate before packing with grout.
 4. Promptly pack shrinkage-resistant grout solidly between bearing surfaces and plates, so no voids remain. Neatly finish exposed surfaces; protect grout and allow to cure. Comply with manufacturer's written installation instructions for grouting.
- C. Maintain erection tolerances of structural steel within ANSI/AISC 303.

3.3 FIELD CONNECTIONS

- A. High-Strength Bolts: Install high-strength bolts in accordance with RCSC's "Specification for Structural Joints Using High-Strength Bolts" for bolt and joint type specified.
1. Joint Type: Snug tightened.
- B. Weld Connections: Comply with AWS D1.1/D1.1M for tolerances, appearances, welding procedure specifications, weld quality, and methods used in correcting welding work.
1. Comply with ANSI/AISC 303 and ANSI/AISC 360 for bearing, alignment, adequacy of temporary connections, and removal of paint on surfaces adjacent to field welds.

3.4 FIELD QUALITY CONTROL

- A. Special Inspections: Owner will engage a special inspector to perform the following special inspections:
1. Verify structural-steel materials and inspect steel frame joint details.
 2. Verify weld materials and inspect welds.
 3. Verify connection materials and inspect high-strength bolted connections.
- B. Testing Agency: Owner will engage a qualified testing agency to perform tests and inspections.
1. Bolted Connections: Inspect and test bolted connections in accordance with RCSC's "Specification for Structural Joints Using High-Strength Bolts."
 2. Welded Connections: Visually inspect field welds in accordance with AWS D1.1/D1.1M.

END OF SECTION 051200

SECTION 26 05 00

COMMON WORK RESULTS FOR ELECTRICAL

PART 1 GENERAL

1.1 PROJECT OVERVIEW

- A. This project consists of construction of new photovoltaic systems for the Lussier Family Heritage Center and the Lak Farm Campground in Madison, Wisconsin.

1.2 SCOPE

- A. The work under this section includes basic electrical requirements, which are applicable to all Division 26 sections. This section includes information common to two or more technical specification sections or items that are of a general nature, not conveniently fitting into other technical sections.

1.3 RELATED WORK

- A. Applicable provisions of Division 1 govern work under this Section.
- B. Section 07 84 00 – Fire Stopping

1.4 REFERENCE STANDARDS

- A. Abbreviations of standards organizations referenced in this and other sections are as follows:

- 1. ANSI American National Standards Institute
- 2. ASTM American Society for Testing and Materials
- 3. EPA Environmental Protection Agency
- 4. ETL Electrical Testing Laboratories, Inc.
- 5. IEEE Institute of Electrical and Electronics Engineers
- 6. IES Illuminating Engineering Society
- 7. ISA Instrument Society of America
- 8. NBS National Bureau of Standards
- 9. NEC National Electric Code
- 10. NEMA National Electrical Manufacturers Association
- 11. NESC National Electrical Safety Code
- 12. NFPA National Fire Protection Association
- 13. UL Underwriters Laboratories Inc.
- 14. DSPS Wisconsin Department of Safety and Professional Services

1.5 REGULATORY REQUIREMENTS

- A. All work and materials are to conform in every detail to applicable rules and requirements of the Wisconsin State Electrical Code (SPS 316), the National Electrical Code (NFPA 70), other applicable National Fire Protection Association codes, the National Electrical Safety Code, and present manufacturing standards (including NEMA).
- B. All Division 26 work shall be done under the direction of a currently licensed State of Wisconsin Master Electrician.

1.6 QUALITY ASSURANCE

- A. Where equipment or accessories are used which differ in arrangement, configuration, dimensions, ratings, or engineering parameters from those indicated on the contract documents, the contractor is responsible for all costs involved in integrating the equipment or accessories into the system and the assigned space, and for obtaining the performance from the system into which these items are placed.
- B. Manufacturer references used herein are intended to establish a level of quality and performance requirements unless more explicit restrictions are stated to apply.
- C. All materials shall be listed by and shall bear the label of an approved electrical testing laboratory. If none of the approved electrical testing laboratories has published standards for a particular item, then other national independent testing standards, if available, applicable, and approved by owner, shall apply and such items shall bear those labels. Where one of the approved electrical testing laboratories has an applicable system listing and label, the entire system shall be so labeled.

1.8 PROTECTION OF FINISHED SURFACES

- A. Furnish one can of touch-up paint for each different color factory finish furnished by the Contractor. Deliver touch-up paint with other "loose and detachable parts" as covered in the General Requirements.

1.9 APPROVED ELECTRICAL TESTING LABORATORIES

- A. The following laboratories are approved for providing electrical product safety testing and listing services as required in these specifications:
 - 1. Underwriters Laboratories Inc.
 - 2. Electrical Testing Laboratories, Inc.

1.10 SLEEVES AND OPENINGS

- A. Refer to Division 1, General Requirements, Sleeves and Openings.

1.11 SEALING AND FIRE STOPPING

- A. Sealing and fire stopping of sleeves/openings between conduits, cable trays, wireways, troughs, cablebus, busduct, etc. and the sleeve, structural or partition opening shall be the responsibility of the contractor whose work penetrates the opening. Provide all fire stopping of fire rated penetrations and sealing of smoke rated penetrations in compliance with section 07 84 00 Fire Stopping.

1.12 INTENT

- A. The Contractor shall furnish and install all the necessary materials, apparatus, and devices to complete the electrical equipment and systems installation herein specified, except such parts as are specifically exempted herein.
- B. If an item is either called for in the specifications or shown on the plans, it shall be considered sufficient for the inclusion of said item in this contract. If a conflict exists within the Specifications or exists within the Drawings, the Contractor shall furnish the item, system, or workmanship, which is the highest quality, largest, or most closely fits the owner's intent. Refer to the General Conditions of the Contract for further clarification.

- C. It must be understood that the details and drawings are diagrammatic. The Contractor shall verify all dimensions at the site and be responsible for their accuracy.
- D. All sizes as given are minimum except as noted.
- E. Materials and labor shall be new (unless noted or stated otherwise), first class, and workmanlike, and shall be subject at all times to the owner's and/or A/E's inspections, tests and approval from the commencement until the acceptance of the completed work.
- F. Whenever a particular manufacturer's product is named, it is intended to establish a level of quality and performance requirements unless more explicit restrictions are stated to apply.

1.13 OMISSIONS

- A. No later than ten (10) days before bid opening, the Contractor shall call the attention of the owner to any materials or apparatus the Contractor believes to be inadequate and to any necessary items of work omitted.

1.14 SUBMITTALS

- A. Submit for all equipment and systems as indicated in the respective specification sections, marking each submittal with that specification section number. Mark general catalog sheets and drawings to indicate specific items being submitted and proper identification of equipment by name and/or number, as indicated in the contract documents. Failure to do this may result in the submittal(s) being returned to the Contractor for correction and resubmission. Failing to follow these instructions does not relieve the Contractor from the requirement of meeting the project schedule.
- B. On request from the owner, the successful bidder shall furnish additional drawings, illustrations, catalog data, performance characteristics, etc.
- C. Submittals shall be grouped to include complete submittals of related systems, products, and accessories in a single submittal. Mark dimensions and values in units to match those specified. Include wiring diagrams of electrically powered equipment.
- D. The submittals must be approved before fabrication is authorized.
- E. Submit sufficient quantities of submittals to allow the following distribution:
 - 1. Operating and Maintenance Manuals 2 copies
 - 2. A/E 1 copy

1.15 PROJECT/SITE CONDITIONS

- A. Install Work in locations shown on drawings, unless prevented by project conditions.
- B. Prepare drawings showing proposed rearrangement of work to meet project conditions, including changes to work specified in other sections. Obtain permission of owner before proceeding.
- C. Tools, materials and equipment shall be confined to areas designated by the owner.

1.16 WORK SEQUENCE AND SCHEDULING

- A. Install work in phases to accommodate owner's occupancy requirements. During the construction period coordinate electrical schedule and operations with owner's Construction Representative.

1.17 WORK BY OTHER TRADES

- A. Every attempt has been made to indicate in this trade's specifications and drawings all work required of this Contractor. However, there may be additional specific paragraphs in other trade specifications and addenda, and additional notes on drawings for other trades which pertain to this trade's work, and thus those additional requirements are hereby made a part of these specifications and drawings.
- B. Electrical details on drawings for equipment to be provided by others are based on preliminary design data only. This Contractor shall lay out the electrical work and shall be responsible for its correctness to match equipment actually provided by others.

1.18 SALVAGE MATERIALS

- A. No materials removed from this project shall be reused. All materials removed shall become the property of and shall be disposed of by the Contractor.

1.19 CERTIFICATES AND INSPECTIONS

- A. Obtain and pay for all required State installation inspections, in accordance with the Wisconsin Administrative Code. Deliver originals of these certificates to the owner's Project Representative.

1.20 OPERATION AND MAINTENANCE DATA

- A. All operations and maintenance data shall comply with the submission and content requirements specified under section GENERAL REQUIREMENTS.

In addition to the general content specified under GENERAL REQUIREMENTS supply the following additional documentation:

1. Manufacturer's wiring diagrams for electrically powered equipment.

1.21 RECORD DRAWINGS

- A. The Contractor shall maintain at least one copy each of the specifications and drawings on the job site at all times.
- B. The owner will provide the Contractor with a suitable set of contract drawings on which daily records of changes and deviations from contract shall be recorded. Dimensions and elevations on the record drawings shall locate all buried or concealed piping, conduit, or similar items.
- C. The daily record of changes shall be the responsibility of Contractor's field superintendent. No arbitrary mark-ups will be permitted.
- D. At completion of the project, the Contractor shall submit the marked-up record drawings to the Architect/Engineer prior to final payment.

PART 2 PRODUCTS

2.1 ACCESS PANELS AND DOORS

A. Lay-in Ceilings:

1. Removable lay-in ceiling tiles in 2 x 2 foot or 2 x 4 foot configuration provided under other divisions are sufficient; no additional access provisions are required unless specifically indicated.

B. Concealed Spline Ceilings:

1. Removable sections of ceiling tile held in position with metal slats or tabs compatible with the ceiling system used will be provided under other divisions.

C. Metal Pan Ceilings:

1. Removable sections of ceiling tile held in position by pressure fit will be provided under other divisions.

D. Plaster Walls and Ceilings:

1. 16 gauge frame with not less than a 20 gauge hinged door panel, prime coated steel for general applications, stainless steel for use in toilets, showers and similar wet areas, concealed hinges, screwdriver operated cam latch for general application, key lock for use in public areas, UL listed for use in fire rated partitions if required by the application. Use the largest size access opening possible, consistent with the space and the equipment needing service; minimum size is 12" by 12".

2.2 IDENTIFICATION

- A. See Electrical section 26 05 53 – Identification for Electrical Systems.

2.3 SEALING AND FIRE STOPPING

A. FIRE AND/OR SMOKE RATED PENETRATIONS:

1. Provide all fire stopping of fire rated penetrations and sealing of smoke rated penetrations in compliance with section 07 84 00 "Fire Stopping".

B. NON-RATED PENETRATIONS:

1. Conduit Penetrations Through Below Grade Walls:

- a. In exterior wall openings below grade, use a modular mechanical type seal consisting of interlocking synthetic rubber links shaped to continuously fill the annular space between the uninsulated conduit and the cored opening or water-stop type wall sleeve.

2. Conduit and Cable Tray Penetrations:

- a. At conduit and cable tray penetrations of non-rated interior partitions, floors and exterior walls above grade, use urethane caulk in annular space between conduit and sleeve, or the core drilled opening.

PART 3 EXECUTION

3.1 EXCAVATION AND BACKFILL

- A. Perform all excavation and backfill work to accomplish indicated electrical systems installation in accordance with section 31 23 16.13 - Trenching. Blasting will not be allowed without written permission of the owner.

3.2 CONCRETE WORK

- A. The Division 3 Contractor will perform all cast-in-place concrete unless noted otherwise elsewhere. Provide all layout drawings, anchor bolts, metal shapes, and/or templates required to be cast into concrete or used to form concrete for the support of electrical equipment.

3.3 CUTTING AND PATCHING

- A. Refer to Division 1, General Requirements, Cutting and Patching.

3.4 BUILDING ACCESS

- A. Arrange for the necessary openings in the building to allow for admittance of all apparatus. When the building access was not previously arranged and must be provided by this contractor, restore any opening to its original condition after the apparatus has been brought into the building.

3.5 EQUIPMENT ACCESS

- A. Install all piping, conduit, ductwork, and accessories to permit access to equipment for maintenance. Coordinate the exact location of wall and ceiling access panels and doors with the General Contractor, making sure that access is available for all equipment and specialties. Where access is required in plaster or drywall walls or ceilings, furnish the access doors to the General Contractor and reimburse the General Contractor for installation of those access doors.

3.6 COORDINATION

- A. The Contractor shall cooperate with other trades and owner in locating work in a proper manner. Should it be necessary to raise or lower or move longitudinally any part of the electrical work to better fit the general installation, such work shall be done at no extra cost to the owner provided such decision is reached prior to actual installation. The Contractor shall check location of electrical outlets with respect to other installations before installing.
- B. The Contractor shall verify that all devices are compatible for the surfaces on which they will be used. This includes, but is not limited to light fixtures, panelboards, devices, etc. and recessed or semi-recessed heating units installed in/on architectural surfaces.
- C. Coordinate all work with other contractors prior to installation. Any installed work that is not coordinated and that interferes with other contractor's work shall be removed or relocated at the installing contractor's expense.
- D. Cooperate with the testing consultant in ensuring specification Section 26 05 04 compliance. Verify system completion to the testing consultant. Demonstrate the starting, interlocking and control features of each system so the testing contractor can perform their work.

3.7 SLEEVES AND OPENINGS

- A. Conduit penetrations in existing concrete floors: Core drill openings.
- B. Where penetrating conduit weight is supported by floor, provide manufactured product or structural bearing collar designed to carry load.

3.8 SEALING AND FIRE STOPPING

A. FIRE AND/OR SMOKE RATED PENETRATIONS:

- 1. Provide all fire stopping of fire rated penetrations and sealing of smoke rated penetrations in compliance with section 07 84 00 Fire Stopping.

B. NON-RATED PENETRATIONS:

- 1. In exterior wall openings below grade, assemble rubber links of mechanical seal to the proper size for the conduit and tighten in place, in accordance with the manufacturer's instructions. Install so that the bolts used to tighten the seal are accessible from the interior of the building or vault.
- 2. At all interior walls and exterior walls, conduit penetrations are required to be sealed. Apply sealant to both sides of the penetration in such a manner that the annular space between the sleeve or cored opening and the conduit is completely blocked.

C. PENETRATIONS SUBJECT TO WATER INTRUSION:

- 1. For penetrations (both rated and non-rated) in floors subject to water intrusion or in rooms housing electrical equipment (but not within walls) provide one of the following:
 - a. Conduit penetration where steel pipe sleeve is used extend steel sleeve 2" above the floor.
 - b. Conduit penetration where cast in place fire stopping device/sleeve is used, extend device/sleeve 2" above the floor (provided it meets the device's UL listing).
 - c. Conduit penetration where there is no steel sleeve or cast in place fire stopping device/sleeve, provide 2"x 2" x 1/8" galvanized steel angles fastened to floor surrounding the penetration or group of penetrations to prevent water from getting to penetration. Provide urethane caulk between angles and floor and fasten angles to floor minimum 8" on center. Seal corners water tight with urethane caulk.
- 2. Floors subject to water intrusion or rooms housing electrical equipment include the following locations:
 - a. Food Service/Kitchen Areas
 - b. Restrooms
 - c. Locker/Shower Rooms
 - d. Janitor Rooms w/ Sinks

- e. Mechanical/Plumbing Equipment Rooms
- f. Maintenance/Industrial Shops
- g. Vehicle Storage and Parking Ramps
- h. Data/Telecommunications Rooms
- i. Electrical Equipment Rooms

- 3. Provide waterproof caulk sealant top coating on fire stopping system (or other approved means to protect the fire stopping system from water) in areas subject to wash down such as Food Service and Dish Washing Areas.

3.9 HOUSEKEEPING AND CLEAN UP

- A. The Contractor shall clean up and remove from the premises, on a daily basis, all debris and rubbish resulting from its work and shall repair all damage to new and existing equipment resulting from its work. When job is complete, this Contractor shall remove all tools, excess material and equipment, etc., from the site.

3.10 TRAINING

- A. Contractor to provide factory authorized representative and/or field personnel knowledgeable with the operations, maintenance and troubleshooting of the system and/or components defined within this section for a minimum period of 8 hours.

END OF SECTION

SECTION 26 05 04

CLEANING, INSPECTION, AND TESTING OF ELECTRICAL EQUIPMENT

PART 1 GENERAL

1.1 SCOPE

- A. The work under this section includes the required cleaning, repair, adjustment, calibration, maintenance and testing of electrical equipment, as specified herein. This applies only to new electrical and existing electrical equipment being furnished, modified, worked on or serviced by this contractor for this project.

1.2 RELATED WORK

- A. Applicable provisions of Division 1 govern work under this Section.

PART 2 PRODUCTS

2.1 Not Used.

PART 3 EXECUTION

3.1 GENERAL INSPECTION AND CLEANING OF ALL ELECTRICAL EQUIPMENT

- A. Inspect for physical damage and abnormal mechanical and electrical conditions.
- B. Any item found to be out of tolerance, or in any other way defective as a result of the required inspection or testing, shall be reported to the owner. Procedure for repair and/or replacement will be outlined. After appropriate corrective action is completed the item shall be re-tested.
- C. Compare equipment nameplate information with the latest single line diagram and report any discrepancies.
- D. Verify proper auxiliary device operation and indicators.
- E. Check tightness of accessible bolted electrical joints. Use torque wrench method.
- F. Make a close examination of equipment and remove any shipping brackets, insulation, packing, etc. that may not have been removed during original installation.
- G. Make a close examination of equipment and remove any dirt or other forms of debris that may have collected in existing equipment or in new equipment during installation.
- H. Clean All Equipment:
 - 1. Vacuum inside of panelboards, switchboards, switchgear, transformer core and coils, bus ducts, MCC's, fire alarm panels, communication/data panels, security panels, etc.
 - 2. Loosen attached particles and vacuum them away.
 - 3. Wipe all insulators with a clean, dry, lint free rag.
 - 4. Clean insulator grooves.
 - 5. Re-vacuum inside surfaces as directed by the Inspector.

- I. Inspect equipment anchorage.
 - J. Inspect equipment and bus alignment.
 - K. Check all heater elements for operation and control.
 - L. Lubricate nonelectrical equipment per manufacturer's recommendations.
- 3.2 GROUNDING SYSTEMS
- A. Inspect the ground system for adequate termination at all devices.
- 3.3 DRY TYPE TRANSFORMERS
- A. Test and adjust the cooling fans, controls and alarm functions.
 - B. Measure secondary voltage phase-to-phase and phase-to-ground after final energization and prior to loading.
 - C. Verify and/or connect transformer "XO" to ground, load side of "WYE" systems.
- 3.4 LIGHTNING ARRESTERS/SURGE SUPPRESSION
- A. Inspect for physical damage such as chipped or fractured porcelain. Wipe clean.
 - B. Perform a ground continuity test to grounding system.
 - C. Verify the proper mounting and adequate clearance.
 - D. Verify the voltage of the units with system one line diagram. Report any discrepancies.
 - E. Verify the electronic surge protection device is connected properly and status lights are normal.
- 3.5 BATTERY SYSTEMS
- A. Inspect for physical damage and evidence of corrosion. Clean units.
 - B. Measure system charging voltage and each individual cell voltage.
 - C. Measure the electrolyte specific gravity and level.
 - D. Verify and compare measured values with manufacturer's specifications.
- 3.6 MECHANICAL AND ELECTRICAL INTERLOCK SYSTEM
- A. Physically test each system to insure proper function, operation and sequencing.
 - B. Closure attempt shall be made on locked open devices.
 - C. Opening attempt shall be made on locked closed devices.
 - D. Key exchange shall be made with devices operated in off normal positions.
- 3.7 SWITCHBOARDS (LOW VOLTAGE)

A. Visual and Mechanical Inspection:

1. Inspect for physical, electrical and mechanical conditions. Re-torque all bolted connections.
2. Compare equipment nameplate information with latest single line diagram and report discrepancies.
3. Inspect for proper alignment, anchorage and grounding
4. All doors, panels and sections shall be inspected for paint, dents, scratches, and fit.
5. Inspect cleanliness

B. Clean switchboard enclosure using the following methods:

1. Loosen attached particles and vacuum them away.
2. Wipe all porcelain with a clean, dry, lint-free rag.
3. Clean all insulator grooves.
4. Vacuum inside of switchgear enclosure.
5. Lubricate per manufacturer's recommendations.

C. All active components shall be exercised and cleaned where possible.

D. All indicating devices shall be inspected for proper operation.

3.8 PANELBOARDS

- A. Torque all the connections per the manufacturers spec. Verify phase wires, color coding, separate neutral and mechanical bonding. Verify circuit breaker operation. Verify the directory.

3.9 MOTOR STARTERS AND MOTOR CONTROL CENTERS

- A. Verify the control circuits. Confirm the fusing and the grounding of the control transformers. Torque all of the connections. Confirm the overload elements and the circuit breakers (fuse) for proper sizing. Verify all grounding. Operate and test each motor starter for proper operation.

3.10 CABLES

A. 600 Volt cable:

1. Visually inspect cables, lugs, connectors and all other components for physical damage and proper connections.
2. Check all cable connectors for tightness (with a torque wrench) and clearances. Torque test conductor terminations to manufacturer's recommendations.
3. Perform a 1000 Vdc megger test on all secondary cables from the substation transformers to the secondary switchboards and on all switchboard feeders.

3.11 LIGHT FIXTURES

- A. Check the bonding and proper lamping. Verify that recessed fixtures are installed with hold down clips. Confirm operation of the fixture with the proper switch or sensor.

3.12 OCCUPANCY SENSORS

- A. Confirm operation of the sensor per the manufacturers spec.

3.13 BATTERY PACK EMERGENCY LIGHTING

- A. Verify the operation per the manufacturers spec and run all of the diagnostic steps. Confirm proper grounding and location.

3.14 UPS SYSTEM

- A. Operate and test the system per the manufacturers spec. Confirm the batteries and liquid level along with the transfer scheme.

3.15 GENERATORS

- A. Run the generator through the standard tests as recommended by the manufacturer including the load bank test. Test the automatic start circuits and run the full diagnostic tests. Verify the fuel and the tank. Check for fuel and coolant leaks.
- B. Provide full load testing utilizing a portable test bank for four hours continuous, minimum. During the first two hours, step increase the load from 0% to 100% in at least six equal steps. At the end of two hours, continue running test at 100% load. Record the following in 20 minute intervals throughout the four hour test: kilowatts, amperes, voltage, coolant temperature, room temperature, generator frequency (Hz), oil pressure, fuel consumption.
- C. After the generator has cooled down from the four hour test, shut it down and then simulate a power failure including operation of the transfer switch, automatic cycle, and automatic shutdown and return to normal.

3.16 AUTOMATIC TRANSFER SWITCHES

- A. Coordinate with the generator and the subsequent tests.
- B. Check the automatic transfer switches and automatic start circuits for proper function.

END OF SECTION

SECTION 26 05 19

LOW-VOLTAGE ELECTRICAL POWER CONDUCTORS AND CABLE

PART 1 GENERAL

1.1 SCOPE

- A. The work under this section includes furnishing and installing required wiring and cabling systems including pulling, terminating and splicing.

1.2 RELATED WORK

- A. Applicable provisions of Division 1 govern work under this Section.
- B. Section 26 05 33 – Raceway and Boxes for Electrical Systems.
- C. Section 26 05 53 – Identification for Electrical Systems.

1.3 REFERENCES

- A. Wisconsin Administrative Code SPS 316 - Electrical

1.4 SUBMITTALS

- A. Submit product data: Provide for each cable assembly type.
- B. Submit factory test reports: Indicate procedures and values obtained.
- C. Submit shop drawings for modular wiring system including layout of distribution devices, branch circuit conduit and cables, circuiting arrangement, and outlet devices.
- D. Submit manufacturer's installation instructions. Indicate application conditions and limitations of use stipulated by product testing agency specified under Regulatory Requirements.

1.5 PROJECT CONDITIONS

- A. Verify that field measurements are as shown on Drawings.
- B. Conductor sizes are based on copper.
- C. Wire and cable routing shown on Drawings is approximate unless dimensioned. Route wire and cable as required to meet project conditions.
- D. Where wire and cable routing is not shown, and destination only is indicated, determine exact routing and lengths required.

PART 2 PRODUCTS

2.1 GENERAL

- A. All wire shall be new, delivered to the site in unbroken cartons and shall be less than one year old out of manufacturer's stock.
- B. All conductors shall be copper.
- C. Insulation shall have a 600 volt rating.

D. All conductors shall be stranded.

1. Stranded conductors may only be terminated with UL OR ETL Listed type terminations or methods: e.g. stranded conductors may not be wrapped around a terminal screw but must be terminated with a crimp type device or must be terminated in an approved back wired method.

2.2 BUILDING WIRE

- A. Description: Single conductor insulated wire 90 degree C.
- B. Insulation: Type THHN/THWN-2, XHHW-2 insulation.

2.3 SERVICE ENTRANCE CONDUCTORS

- A. Description: Single conductor or multi-conductor insulated wire. 90 degree C sized at the 75 degree C table.
- B. Insulation:
 1. Type USE-2, XHHW-2 insulation for service entrance conductors routed from exterior source to exterior termination location.
 2. Type XHHW-2 insulation for services entrance conductors routed from exterior source to interior termination location.

2.4 PHOTOVOLTAIC WIRE

- A. Description: Single conductor or multi-conductor insulated wire. 90 degree C.
- B. Insulation:
 - a. Type PV-WIRE for exterior connection and routing along collectors and to combiner boxes.

2.5 ABOVE GROUND WIRE FOR EXTERIOR WORK

- A. Description: Single conductor insulated wire, 90 degree C.
- B. Insulation: Type THHN/THWN-2, XHHW-2 insulation.

2.6 UNDERGROUND WIRE FOR EXTERIOR WORK

- A. Description: Stranded single or multiple conductor insulated wire, 90 degree C.
- B. Insulation: Type USE-2, XHHW-2, RHW-2 insulation.
- C. This wiring shall be used in all underground feeder and branch circuit applications, except THHN/THWN-2 is permitted when run in a concrete-encased ductbank.

2.8 WIRING CONNECTORS

- A. Split Bolt Connectors: Not acceptable.
- B. Solderless Pressure Connectors: High copper alloy terminal. May be used only for cable termination to equipment terminals. Not approved for splicing.

- C. Twist Type Wire Connectors: Solderless twist type spring connector (wire-nut) with insulating cover for copper wire splices and taps. Use for conductor sizes 10 AWG and smaller. The manufacturer's wire fill capacity must be followed.
 - 1. All wire connectors used in underground or exterior pull boxes or hand holes shall be gel filled twist connectors or a connector designed for damp and wet locations. Gel filled twist type connectors can be used for copper conductor sizes 6 AWG and smaller for site lighting applications. The manufacturer's wire fill capacity must be followed.
- D. Mechanical Connectors: Bolted type tin-plated; high conductivity copper alloy; spacer between conductors; beveled cable entrances.
- E. Compression (crimp) Connectors: Long barrel; seamless, tin-plated electrolytic copper tubing; internally beveled barrel ends. Connector shall be clearly marked with the wire size and type and proper number and location of crimps. Connector must be installed with a crimper tool listed for use with the manufacturer and type of compression connector.
- F. Insulation Piercing Connectors: Molded insulated body, copper teeth, wrench tightened, UL 486B Listed. May be used only for connection of a tap conductor in run and tap type applications when main conductor is 8 AWG and larger.

PART 3 EXECUTION

3.1 GENERAL WIRING METHODS

- A. All wire and cable shall be installed in conduit.
- B. Do not use wire smaller than 12 AWG for power and lighting circuits.
- C. All phase, neutral and ground conductors shall be sized to prevent excessive voltage drop at rated circuit ampacity. As a minimum use 10 AWG conductors for 20 ampere, 120 volt branch circuit home runs longer than 100 feet (30 m), and for 20 ampere, 277 volt branch circuit home runs longer than 200 feet (61 m).
- D. Make conductor lengths for parallel conductors equal.
- E. Splice only in junction or outlet boxes.
- F. No conductor less than 10 AWG shall be installed in exterior underground conduit.
- G. Identify ALL low voltage wire, 600V and lower, per section 26 05 53.
- H. Neatly train and lace wiring inside boxes, equipment, and panelboards.

3.2 WIRING INSTALLATION IN RACEWAYS

- A. Pull all conductors into a raceway at the same time. Use Listed water or silicone based wire pulling lubricant for pulling 4 AWG and larger wires and for other conditions when necessary. Wax based lubricants are not allowed. Pulling lubricant is not required for low friction type products where the cable manufacturer recommends that cables be pulled without lube.
- B. Install wire in raceway after interior of building has been physically protected from the weather and all mechanical work likely to injure conductors has been completed.

- C. Completely and thoroughly swab raceway system before installing conductors.
- D. Place all conductors of a given circuit (this includes phase wires, neutral (if any), and ground conductor) in the same raceway. If parallel phase and/or neutral wires are used, then place an equal number of phase and neutral conductors in same raceway or cable.
- E. VFD Installations: Install VFD input wiring and output wiring in separate conduit systems. Do not mix VFD input power and output power, or control wiring in a common raceway.
- F. In high ambient spaces, mechanical rooms, utility rooms and exterior exposed conduit, 90 degree C conductors shall be utilized.

3.3 WIRING CONNECTIONS AND TERMINATIONS

- A. Splice only in accessible junction boxes.
- B. Wire splices and taps shall be made firm, and adequate to carry the full current rating of the respective wire without soldering and without perceptible temperature rise.
- C. All splices shall be so made that they have an electrical resistance not in excess of two feet (600 mm) of the conductor.
- D. Use solderless twist type spring connectors (wire nuts) with insulating covers for wire splices and taps, 10 AWG and smaller.
- E. Use mechanical or compression connectors for wire splices and taps, 8 AWG and larger. Tape uninsulated conductors and connectors with electrical tape to 150 percent of the insulation value of the wiring.
- F. Thoroughly clean wires before installing lugs and connectors.
- G. At all splices and terminations, leave tails long enough to cut splice out and completely re-splice.

3.4 FIELD QUALITY CONTROL

- A. Field inspection and testing will be performed under provisions of Section 26 05 04.

3.5 WIRE COLOR

- A. General:
 - 1. Solid colored insulation is required for all THHN/THWN-2 wire. For other wire types use colored wire or identify wire with colored tape at all terminals, splices and boxes. Wire shall be colored as indicated below.
 - 2. In existing facilities, use existing color scheme.
 - 3. In new facilities, use black and red for single phase circuits at 120/240 volts, use Phase A black, Phase B red and Phase C blue for circuits at 120/208 volts single or three phase, and use Phase A brown, Phase B orange and Phase C yellow for circuits at 277/480 volts single or three phase. Note: This includes fixture whips except for Listed whips mounted by the fixture manufacturer on the fixture and Listed as a System.

4. Switch legs shall be the same color as their associated circuit, except for the second switch leg used for dual-level switching. The second switch leg shall be the next phase color, e.g. if the first switch leg is brown (277/480V phase A), the second switch leg shall be orange (277/480V phase B).
 5. Traveler conductors run between 3 and 4 way switches shall be colored pink or purple.
- B. Neutral Conductors: White for 120/208V and 120/240V systems, Gray for 277/480V systems. Where there are two or more neutrals in one conduit, each shall be individually identified with a different stripe.
 - C. Branch Circuit Conductors: Three or four wire home runs shall have each phase uniquely color coded.
 - D. Feeder Circuit Conductors: Each phase shall be uniquely color coded.
 - E. Ground Conductors: Green colored insulation for THHN/THWN-2 wire. For other wire types use green colored wire or identify wire with green tape at both ends and at all access points, such as panelboards, motor starters, disconnects and junction boxes. When isolated grounds are required, contractor shall provide green with yellow tracer.

3.6 BRANCH CIRCUITS

- A. The use of single-phase, multi-wire branch circuits with a common neutral is not permitted. All single-phase branch circuits shall be furnished and installed with an individual accompanying neutral, sized the same as the phase conductors.

3.7 EMERGENCY CIRCUITS

- A. All Emergency, Legally Required Standby and Optional Standby system wiring shall be installed in separate raceways after their associated transfer switches. The wiring shall be separate from each other and from all normal system wiring.
- B. All emergency wiring serving fire pumps, requiring minimum 2 hour fire rating shall comply with NEC 695.6(B).
- C. All emergency wiring serving NEC 700 loads, requiring minimum 2 hour fire rating shall comply with NEC 700.10(D)(1).
- D. All generator control conductors installed between transfer equipment and the emergency generator serving Emergency, Legally Required Standby and Optional Standby systems shall be kept entirely independent of all other wiring. This shall require a dedicated conduit system between each transfer switch and the emergency generator. If a Fire Pump is served off the emergency generator, a separate conduit shall be provided between fire pump controller and generator.

END OF SECTION

SECTION 26 05 26

GROUNDING AND BONDING FOR ELECTRICAL SYSTEMS

PART 1 GENERAL

1.1 SCOPE

- A. The work under this section includes grounding electrodes and conductors, equipment grounding conductors, and bonding.
- B. All hardware, cables and related termination and support hardware shall be furnished, installed, wired, tested, labeled, and documented by the Contractor, as detailed in this and related sections.

1.2 RELATED WORK

- A. Applicable provisions of Division 1 govern work under this Section.

1.3 REFERENCES

- A. Wisconsin Administrative Code SPS 316 – Electrical
- B. ANSI/IEEE 142 (Latest edition) - Recommended Practice for Grounding of Industrial and Commercial Power Systems
- C. UL 467 Electrical Grounding and Bonding Equipment
- D. IEEE 837 - IEEE Standard for Qualifying Permanent Connections Used in Substation Grounding
- E. ANSI J-STD-607-B - Commercial Building Grounding (Earthing) and Bonding Requirements for Telecommunications
- F. TIA/EIA-606-A - Administration Standard for Commercial Telecommunications Infrastructure

1.4 PERFORMANCE REQUIREMENTS

- A. Grounding System Resistance:
 - 1. Equipment Rated 500 KVA and Less: 10 ohms maximum at building service entrance.
 - 2. Equipment Rated 500 to 1000 KVA: 5 ohms maximum at building service entrance.
 - 3. Equipment Rated more than 1000 KVA: 3 ohms building service entrance.
 - 4. Communications Busbars: 5 ohms maximum.
- B. Testing of grounding system resistance is to be witnessed by the electrical inspector and/or owner's Field Representative. Provide test report of grounding system resistance in final O&M manuals.

1.5 SUBMITTALS

- A. Product Data: Provide data for grounding electrodes and connections.

RFB: 320010

GROUNDING AND BONDING FOR
ELECTRICAL SYSTEMS

26 05 26 - 1

- B. Test Reports: Indicate overall resistance to ground [and resistance of each electrode].
- C. Manufacturer's Instructions: Include instructions for preparation, installation and examination of exothermic connectors.

1.6 PROJECT RECORD DOCUMENTS

- A. Accurately record locations of all ground rods and other grounding electrodes.

1.7 REGULATORY REQUIREMENTS

- A. Conform to requirements of NFPA 70.
- B. Furnish products listed and classified by Underwriters Laboratories, Inc. or testing firm acceptable to authority having jurisdiction as suitable for purpose specified and shown.

PART 2 PRODUCTS

2.1 ROD ELECTRODE

- A. Material: Copper-clad steel.
- B. Diameter: 3/4 inch (19 mm) minimum.
- C. Length: 10 feet (3.5 m) minimum. Rod shall be driven at least 9' 6" deep.

2.2 CONCRETE-ENCASED GROUNDING ELECTRODE FOR POLE BASES

- A. Fabricate per NFPA 70, Article 250.52 (A)(3) using 20 feet (6m) of bare copper wire not smaller than #4 AWG. If concrete foundation is less than 20 feet (6m) long, coil excess conductor within the base of the foundation. Bond grounding conductor to reinforcing steel in at least four locations and to anchor bolts.

2.3 MECHANICAL CONNECTORS

- A. The mechanical connector bodies shall be manufactured from high strength, high conductivity cast copper alloy material. Bolts, nuts, washers and lock washers shall be made of Silicon Bronze and supplied as a part of the connector body and shall be of the two bolt type.
- B. Split bolt connector types are NOT allowed. Exception: the use of split bolts is acceptable for grounding of wire-basket type cable tray.
- C. The connectors shall meet or exceed UL 467 and be clearly marked with the catalog number, conductor size and manufacturer.

2.4 COMPRESSION CONNECTORS

- A. The compression connectors shall be manufactured from pure wrought copper. The conductivity of this material shall be no less than 99% by IACS standards.
- B. Each connector shall be factory filled with an oxide-inhibiting compound.
- C. The connectors shall meet or exceed the performance requirements of IEEE 837, latest revision.

- D. The connectors shall be clearly marked with the manufacturer, catalog number, conductor size and the required compression tool settings.
- E. The installation of the connectors shall be made with a compression tool and die system, as recommended by the manufacturer of the connectors, and shall be irreversible.
- F. Pre-crimping of the ground rod is required for all irreversible compression connections to a ground rod.
- G. Terminal lug for communication system grounding shall be compression type and conform to the following:
 - 1. Material: Tin Plated Copper (aluminum not permitted).
 - 2. Wire Size: to match conductor
 - 3. Number of Stud Holes: 2
 - 4. Stud Hole Size: 3/8"
 - 5. Bolt Hole Spacing: per ANSI Joint Standard J-STD-607-A
 - 6. Tongue Angle: Straight

2.5 EXOTHERMIC CONNECTIONS

- A. As manufactured by Cadweld or similar.

2.6 CONDUCTORS

- A. Material: Stranded copper (aluminum not permitted).
- B. Grounding Electrode Conductor: Size as shown on drawings, specifications or as required by NFPA 70, whichever is larger.
- C. Foundation Electrodes: As shown on drawings.
- D. Primary Manhole, Main Switchgear room and Vault Bonding: No. 4/0 minimum.
- E. Feeder and Branch Circuit Equipment Ground: Size as shown on drawings, specifications or as required by NFPA 70, whichever is larger. Differentiate between the normal ground and the isolated ground when both are used at the same facility.
- F. Branch Circuit Equipment Grounds shall be increased in size when routed with phase conductors increased in size due to voltage drop calculations.
- G. Conductors for Telecommunications shall be as follows:
 - 1. Telecommunications Bonding Conductor: No. 3/0 minimum or as shown on drawings.
 - 2. Telecommunications Bonding Backbone: No. 3/0 minimum or as shown on drawings.
 - 3. Telecommunications Grounding Equalizer (GE): No. 3/0 minimum or as shown on drawings.

4. Bonding Conductors shall be insulated with a Green Jacket or jacket marked with Green Tape or labeled per NEC Guidelines

2.7 BUS/BUSBAR

- A. Material: Copper (aluminum not permitted).
- B. Size:
 1. All Power systems: 1/4" X 2", length as needed (24" minimum).
 2. Telecommunications Main Ground Busbar (TMGB): 1/4" x 4" x 20" long (minimum).
 3. Telecommunications Grounding Busbar (TGB): 1/4" x 2" x 12" long (minimum).
- C. Busbars:
 1. Be pre-drilled to accommodate two-hole lugs.
 2. 3/8" stud hole size; hole spacing per ANSI J-STD-607-A.
 3. Incorporate insulators and stand-off brackets that electrically isolate busbar from mounting surface.
- D. Provide main ground busbar located adjacent to main electrical service equipment to terminate all ground conductors.

PART 3 EXECUTION

3.1 EXAMINATION

- A. Verify that final backfill and compaction has been completed before driving rod electrodes.

3.2 GENERAL

- A. Install Products in accordance with manufacturer's instructions.
- B. Mechanical connections shall be accessible for inspection and checking. No insulation shall be installed over mechanical ground connections.
- C. Ground connection surfaces shall be cleaned and all connections shall be made so that it is impossible to move them.
- D. Attach grounds permanently before permanent building service is energized.
- E. Terminate each grounding conductor on its own terminal lug. Sharing a single lug by multiple conductors is not allowed.
- F. All grounding electrode conductors and individual grounding conductors shall be installed in PVC conduit, in exposed locations.

3.3 LESS THAN 600 VOLT ELECTRICAL SYSTEM GROUNDING

- A. Supplementary Grounding Electrode: Use driven ground rod on exterior of building.

RFB: 320010

GROUNDING AND BONDING FOR
ELECTRICAL SYSTEMS

26 05 26 - 4

- B. Provide code sized copper grounding electrode conductor from electrical room ground bus to secondary switchboard ground bus, each separately derived system neutral, secondary service system neutral to street side of water meter, building steel, ground rod, and any concrete encased electrodes. Provide bonding jumper around water meter.
- C. Equipment Grounding Conductor: Provide separate, insulated equipment grounding conductor within each raceway. Terminate each end on suitable lug, bus, enclosure or bushing. Provide a ground wire from each device to the respective enclosure.
- D. Bond together system neutrals, service equipment enclosures, exposed non-current carrying metal parts of electrical equipment, metal raceway systems, grounding conductor in raceways and cables, receptacle ground connectors, and plumbing systems.
- E. Install ground grid under access floors where indicated. Construct grid of #4 AWG bare copper wire installed on 72 inch centers both ways. Bond each access floor support pedestal to grid.
- F. Bond together each metallic raceway, pipe, duct and other metal object entering space under access floors. Bond to under floor ground grid. Use #4 AWG bare copper conductor.

3.4 COMMUNICATION SYSTEM GROUNDING

- A. Grounding and Bonding System for Communications shall be an isolated grounding system with a single ground point. That ground point is to be the common grounding electrode system at the building electrical service entrance (main ground bar located in electrical room).
- B. The system shall be compliant with ANSI J-STD-607-B with the exception that the ground cable shall not be bonded to building steel except at the electrical service entrance.
- C. Provide Grounding Busbar for Telecommunications at each Telecommunications Room, the Main Equipment Room and at the electrical service entrance per project drawings. Coordinate Busbar location(s) and conductor routing per drawings with Division 27 contractor.
- D. Provide Telecommunications Bonding Conductor from Telecommunications Main Grounding Busbar (TMGB) at the Communications Entrance Facility to building common grounding electrode system. Attach grounding conductor to building steel as allowed only at the main electrical service entrance.
- E. Provide Telecommunications Bonding Backbone (TBB) conductor from the TMGB to Telecommunications Grounding Busbar (TGB) at each Telecommunication Room, Telecommunications Equipment Room and Telecommunications Enclosure.
- F. TBB shall be continuous and not connected through Telecommunications Grounding Busbars (TGBs).
- G. Bond TGBs to TBB via tap off of TBB. Gauge of conductor to be same as TBB.
- H. Leave 10 feet slack in conductor from TBB to TGB at TGB location(s).
- I. Do not bond TBB or TGB to building steel at TGB location(s).
- J. Provide Grounding Equalizer(s) (GE) per project drawings. Connect GE conductor directly to TGBs being interconnected.

3.5 FIELD QUALITY CONTROL

- A. Inspect grounding and bonding system conductors and connections for tightness and proper installation.
- B. Testing of grounding system resistance is to be witnessed by the DSF electrical inspector or Field Representative. Provide test report of grounding system resistance in final O&M manuals.

3.6 IDENTIFICATION AND LABELING

- A. Label Grounds at point of termination.
- B. Label the connections from the Telecommunications Bonding Backbone (TBB) conductor to the Telecommunications Main Grounding Busbar (TMGB) and the Telecommunications Grounding Busbar TGB(s). The label shall be plastic and include the following:

IF THIS CONNECTOR OR CABLE IS
LOOSE OR MUST BE REMOVED,
PLEASE CALL THE BUILDING
TELECOMMUNICATIONS
MANAGER.

END OF SECTION

HANGERS AND SUPPORTS FOR ELECTRICAL SYSTEMS

PART 1 GENERAL

1.1 SCOPE

- A. The work under this sections includes conduit and equipment supports, straps, clamps, steel channel, etc., and fastening hardware for supporting electrical work.

1.2 RELATED WORK

- A. Applicable provisions of Division 1 govern work under this Section.
- B. Section 26 05 53 – Identification for Electrical Systems

1.3 SUBMITTALS

- A. Product Data: Provide data for support channel.

1.4 QUALITY ASSURANCE

- A. Support systems shall be adequate for weight of equipment and conduit, including wiring, which they carry.

PART 2 PRODUCTS

2.1 MATERIAL

- A. Support Channel: Steel, Galvanized, Enameled or other corrosion resistant.
- B. Hardware: Corrosion resistant.
- C. Minimum sized threaded rod for supports shall be 3/8” for trapezes and single conduits 1-1/4” and larger, and 1/4” for single conduits 1” and smaller.
- D. Conduit clamps, straps, supports, etc., shall be steel or malleable iron. One-hole straps shall be heavy duty type. All straps shall have steel or malleable backing plates when rigid steel conduit is installed on the interior or exterior surface of any exterior building wall.

PART 3 EXECUTION

3.1 INSTALLATION

- A. Fasten hanger rods, conduit clamps, outlet, junction and pull boxes to building structure using pre-cast insert system, preset inserts, beam clamps, expansion anchors, or spring steel clips (interior metal stud walls only).
- B. Use toggle bolts or hollow wall fasteners in hollow masonry, plaster, or gypsum board partitions and walls; expansion anchors or preset inserts in solid masonry walls; self-drilling anchors or expansion anchors on concrete surfaces; sheet metal screws in sheet metal studs and wood screws in wood construction. If nail-in anchors are used, they must be removable type anchors.

- C. Powder-actuated fasteners are not permitted. Compressed-air power-actuated fasteners may ONLY be used for the installation of separate ceiling wires required for support of conduits and aircraft cable hung light fixtures.
- D. File and de-bur cut ends of support channel and spray paint with cold galvanized paint to prevent rusting.
- E. Do not fasten supports to piping, ductwork, mechanical equipment, cable tray or conduit. Do not fasten to suspended ceiling grid system.
- F. Support wires that are installed in addition to the ceiling grid support wires to provide secure support for raceways, cables assemblies, boxes, cabinets, and fittings shall be secured at both ends (e.g. the ceiling structure at the top and the ceiling grid at the bottom) per NEC 300.11(A).
- G. Support wires shall be identified per specification section 26 05 53.
- H. Do not drill structural steel members unless approved by A/E.
- I. Fabricate supports from galvanized structural steel or steel channel, rigidly welded or bolted to present a neat appearance. Use hexagon head bolts with spring lock washers under all nuts.
- J. In wet locations, mechanical rooms, and electrical rooms, install free-standing electrical equipment on 3.5-inch (89 mm) concrete pads.
- K. Install surface-mounted cabinets and panelboards with a minimum of four anchors. At all cabinet and panelboard locations on concrete or concrete block walls, and at ALL locations below grade, provide steel channel supports to stand cabinet one inch (25 mm) off wall (7/8" Uni-strut or 3/4" painted fire-retardant plywood is acceptable). In above-grade equipment rooms that have drywall walls, the cabinets and panelboards may be mounted to the drywall if backing is provided in the stud walls behind the equipment.
- L. Bridge studs top and bottom with channels to support flush-mounted cabinets and panelboards in stud walls.
- M. Furnish and install all supports as required to fasten all electrical components required for the project, including free standing supports required for those items remotely mounted from the building structure, catwalks, walkways etc.

END OF SECTION

SECTION 26 05 33

RACEWAY AND BOXES FOR ELECTRICAL SYSTEMS

PART 1 GENERAL

1.1 SCOPE

- A. This section describes the products and execution requirements relating to furnishing and installing raceways and boxes and related systems as part of a raceway system for electrical, communications, and other low-voltage systems for the project.

1.2 RELATED WORK

- A. Applicable provisions of Division 1 govern work under this section.
 - 1. Section 26 05 26 – Grounding and Bonding for Electrical Systems
 - 2. Section 26 05 29 – Hangers and Supports for Electrical Systems.
 - 3. Section 26 27 02 – Equipment Wiring Systems.
 - 4. Section 26 27 26 – Wiring Devices.
 - 5. Section 27 10 00 – Technology Cabling System

1.3 SUBMITTALS

- A. Surface Raceway System - submit product data and catalog sheets for all components.
- B. Boxes - provide product data showing configurations, finishes, dimensions, and manufacturer's instructions.
- C. Conduits in Concrete Slabs Above Grade - provide proposed conduit routing and sizing to Structural Engineer prior to approval of installation to verify structural integrity and fire rating of concrete slab.

PART 2 PRODUCTS

2.1 GENERAL

- A. All steel fittings and conduit bodies shall be galvanized.
- B. No cast metal or split-gland type fittings permitted.
- C. Mogul-type condulets larger than 2 inch (50 mm) not permitted except as approved or detailed.
- D. All conduit covers must be fastened to the conduit body with screws and be of the same manufacture.
- E. C-condulets shall not be used in lieu of pull boxes.

- F. All boxes shall be of sufficient size to provide free space for all conductors enclosed in the box and shall comply with NEC requirements.

2.2 RIGID METAL CONDUIT (RMC) AND FITTINGS

- A. Conduit: Heavy wall threaded, galvanized steel, schedule 40.
- B. Fittings and Conduit Bodies: Use all steel threaded fittings and conduit bodies.
- C. Expansion Fittings/Expansion Joints: Expansion Fittings shall be Internal Grounding type and shall not rely on external bonding jumpers to maintain grounding continuity between raceway components.

2.3 PVC COATED RIGID METAL CONDUIT

- A. PVC Externally Coated Conduit: Rigid heavy wall, schedule 40, steel conduit with external 40 mil (0.1 mm) PVC coating. Conduit must be hot dipped galvanized inside and out including threads. The PVC coating bond to the galvanized steel conduit shall be stronger than the tensile strength of the coating itself.
- B. Fittings and Conduit Bodies: Threaded type, material to match conduit. PVC coated fittings and couplings shall have specially formed sleeves to tightly seal to conduit PVC coating. The sleeves shall extend beyond the fitting or coupling a distance equal to the pipe outside steel diameter or two inches (50 mm) whichever is greater.

2.4 INTERMEDIATE METAL CONDUIT (IMC) AND FITTINGS

- A. Conduit: Galvanized steel, threaded.
- B. Fittings and Conduit Bodies: Use all steel threaded fittings and conduit bodies.
- C. Expansion Fittings/Expansion Joints: Expansion Fittings shall be Internal Grounding type and shall not rely on external bonding jumpers to maintain grounding continuity between raceway components.

2.5 ELECTRICAL METALLIC TUBING (EMT) AND FITTINGS

- A. Conduit: Steel, galvanized tubing.
- B. Fittings: All steel, set screw type. No push-on or indenter types permitted.
- C. Conduit Bodies: All steel threaded conduit bodies.

2.6 FLEXIBLE METAL CONDUIT (FMC) AND FITTINGS

- A. Conduit: steel, galvanized, spiral strip.
- B. Fittings and Conduit Bodies: All steel, galvanized, or malleable iron (except as allowed in specification 26 51 13).

2.7 LIQUIDTIGHT FLEXIBLE METAL CONDUIT (LFMC) AND FITTINGS

- A. Conduit: flexible, steel, galvanized, spiral strip with an outer Liquidtight, nonmetallic, sunlight-resistant jacket.
- B. Fittings and Conduit Bodies: ANSI/NEMA FB 1, compression type. There shall be a metallic cover/insert on the end of the conduit inside the connector housing to seal the cut conduit end.

2.8 RIGID POLYVINYL CHLORIDE CONDUIT (PVC) AND FITTINGS

- A. Conduit: Rigid non-metallic conduit, Schedule 40 PVC minimum, Listed, sunlight resistant, rated for 900 C conductors. Schedule 80 for locations exposed to physical damage or as required.
- B. Fittings and Conduit Bodies: NEMA TC 2, Listed.

2.9 FIBERGLASS RESIN CONDUIT (RTRC) AND FITTINGS

- A. Conduit: Reinforced Thermosetting Resin Conduit RTRC, Type AG (Above Ground) and XW (Exposed), and UL 2515 AG (Above Ground) or UL 2420 BG (Below Ground) listed.
- B. Fittings, Factory Elbows and Conduit Bodies: Match Conduit.

2.10 HIGH DENSITY POLYETHYLENE CONDUIT (HDPE) AND FITTINGS

- A. Conduit: Continuous length smooth-wall HDPE conduit for electrical applications produced to ASTM F2160. Conduit shall be listed by a Nationally Recognized Testing Laboratory to UL Standard 651-A for smooth-wall duct to be used as electrical conduit for the installation of Listed electrical cables underground.
- B. The recommended HDPE color is black or black with red stripes. Red identifies the conduit as electrical and black provides UV protection for storage and at points where the conduit may exit the ground.
- C. Fittings: Threaded Mechanical Fittings: Aluminum reverse-threaded conduit couplers designed for use with HDPE conduit. Compression Fittings and Socket Couplings designed for use with HDPE conduit may also be used.

2.11 CONDUIT SUPPORTS

- A. See section 26 05 29.

2.12 SURFACE METAL RACEWAY

- A. Description: Sheet metal channel with fitted cover, suitable for use as surface metal raceway.
- B. Size: As shown on Drawing.

- C. Finish: As shown on Drawing.
- D. Fittings: Couplings, elbows, and connectors designed for use with raceway system.
- E. Boxes and Extension Rings: Designed for use with raceway systems.

2.13 SURFACE NONMETAL RACEWAY

- A. Description: Nonmetallic channel with fitted cover, suitable for use as surface raceway.
- B. Size: As shown on Drawing.
- C. Color: As shown on Drawing.
- D. Fittings: Couplings, elbows, and connectors designed for use with raceway system.
- E. Boxes and Extension Rings: Designed for use with raceway systems.

2.14 CONDUIT WATER SEALANT

- A. Description: Conduit sealant used to prevent water from entering buildings via conduits.
- B. Sealant shall seal conduits against water and gas intrusion, such as Polywater® FST™-250 Foam Duct Sealant, Raychem RDSS Rayplate Duct Sealing System, or approved alternate. Sealant shall be re-enterable, shall be compatible with the conduit and conductor types being used, and shall comply with NEC 225.27, 230.8, and 300.5(G).
- C. Manufacturer names and catalog numbers are used to develop quality and performance requirements only. Products manufactured by others may be acceptable provided they meet or exceed the specifications.

2.15 PULL AND JUNCTION BOXES

- A. Interior Sheet Metal Boxes: code gauge galvanized steel, screw covers, flanged and spot welded joints and corners.
- B. Interior Sheet Metal Boxes larger than 12 inches (300 mm) in any dimension shall have a hinged cover or a chain installed between box and cover.
- C. Exterior Boxes and Wet Location Installations: Type 4 and Type 6, flat-flanged, surface-mounted junction box, UL listed as rain-tight. Galvanized cast iron, Aluminum, box and cover with ground flange, neoprene gasket, and stainless steel cover screws.

- D. Box extensions and adjacent boxes within 48 inches of each other are not allowed for the purpose of creating more wire capacity.
- E. Junction boxes 6 inch-by-6 inch or larger size shall be without stamped knock-outs.
- F. Wireways shall not be used in lieu of junction boxes.

2.16 OUTLET BOXES

- A. Sheet Metal Outlet Boxes: galvanized steel, with stamped knockouts.
- B. Luminaire and Equipment Supporting Boxes: Rated for weight of equipment supported; include 3/8 inch male fixture studs where required.
- C. Concrete Ceiling Boxes: Concrete type.
- D. Cast Boxes: Cast ferroalloy or aluminum, deep type, gasketed cover, threaded hubs.

2.17 FLOOR BOXES

- A. Floor Boxes for Installation in Cast-In-Place Concrete Floors: As indicated on drawings. Provide boxes with sufficient capacity to house the devices indicated on the plans.
- B. Type: Flush service.
- C. Floor Cover: As indicated on drawings. Floor plates shall meet and exceed UL scrub water exclusion requirements for concrete, tile, carpet, and wood covered floors.
- D. Device Plate: Stainless steel or as available from manufacturer.
- E. Configuration: As indicated on drawings.

2.18 POKE-THROUGH ASSEMBLIES

- A. Description: Assembly comprising of service fitting, poke-through component, fire stops and smoke barriers, and junction box for conduit termination.
- B. Fire Rating: Two-hour rated, or rated to match existing floor.
- C. Type: As indicated on drawings.
- D. Floor Plate: As indicated on drawings. Floor plates shall meet and exceed UL scrub water exclusion requirements for concrete, tile, carpet, and wood covered floors.
- E. Device Plate: Stainless steel or as available from manufacturer.
- F. Configuration: As indicated on drawings.

2.19 FLAT SCREEN MONITOR BOXES

- A. Provide a recessed wall box for mounting behind flat screen monitors, allowing the screens to sit flush against the wall. These boxes shall provide a neat and secure environment for the audio, video, control and power connections.
- B. The recessed wall box shall install easily between any two standard studs in the wall. Connections and cable entry can be on the top or the bottom depending on installation preference.
- C. The recessed wall box shall be provided with one low-voltage conduit entry box and Nationally Recognized Testing Laboratory (NRTL) listed single gang box for AC power.
- D. The recessed wall box cover shall be provided in white or black and shall be suitable for painting. The cover shall have a cable exit slot for the display connections and the excess cable can easily be hidden inside of the box making the entire installation as clean as possible. The cover screws onto the front of the box once all connections are in place.
- E. The recessed wall box shall be designed for new or existing construction. Brackets shall be included for mounting to studs in new construction as well as surface mount clips for mounting to sheet rock or plywood in existing construction.

PART 3 EXECUTION

3.1 CONDUIT SIZING, ARRANGEMENT, AND SUPPORT

- A. EMT is permitted to be used in sizes 4 inch (100 mm) and smaller for power and low-voltage systems. See CONDUIT INSTALLATION SCHEDULE below for other limitations for EMT and other types of conduit.
- B. Size power conductor raceways for conductor type installed. Conduit size shall be 1/2 inch (16 mm) minimum except all homerun conduits shall be 3/4 inch (21 mm), or as specified elsewhere. Caution: Per the NEC, the allowable conductor ampacity is reduced when more than three current-carrying conductors are installed in a raceway. Contractor must take the NEC ampacity adjustment factors into account when sizing the raceway and wiring system.
- C. Size communications and other low-voltage systems raceways as follows:
 - 1. Communications, including Outlet Box: 1 1/4 inch minimum. Conduit used for single device locations (e.g. Wireless Access Point, Video Surveillance Camera, and Wall mounted telephone) may be 3/4 inch minimum.
 - 2. Control, security, signal, video, and other low-voltage applications: 3/4 inch minimum.
 - 3. Fire Alarm: 1/2 inch minimum.
 - 4. Floor Box and Poke-Through Assemblies:

- a. Power: 3/4 inch minimum or as indicated on drawings.
 - b. Low-voltage: 1 inch minimum or as indicated on drawings.
- D. Provide one raceway from each communications outlet box to above accessible ceiling.
- E. Arrange conduit to maintain 6'-8" clear headroom and present a neat appearance.
- F. Route exposed conduit and conduit above accessible ceilings parallel and perpendicular to walls and adjacent piping.
- G. Maintain minimum 6 inch (150 mm) clearance between conduit and piping. Maintain 12 inch (300 mm) clearance between conduit and heat sources such as flues, steam pipes, and heating appliances.
- H. Arrange conduit supports to prevent distortion of alignment by wire pulling operations. Fasten conduit using galvanized pipe straps, conduit racks (lay-in adjustable hangers), clevis hangers, or bolted split stamped galvanized hangers.
- I. Group conduit in parallel runs where practical and use conduit rack (lay-in adjustable hangers) constructed of steel channel with conduit straps or clamps. Provide space for 25 percent additional conduit.
- J. Do not fasten conduit with wire or perforated pipe straps. Before conductors are pulled, remove all wire used for temporary conduit support during construction.
- K. Support and fasten metal conduit at a maximum of 8 feet (2.4 m) on center.
- L. Supports shall be independent of the installations of other trades, e.g. ceiling support wires, HVAC pipes, other conduits, etc., unless so approved or detailed.
- M. Conceal all conduits except where noted on the drawings or approved by the Architect/Engineer. Contractor shall verify with Architect/Engineer all surface conduit installations except in mechanical rooms.
- N. Changes in direction shall be made with symmetrical bends, cast steel boxes, stamped metal boxes or cast steel conduit bodies.
- O. For indoor conduits, no continuous conduit run shall exceed 100 feet (30 meters) without a junction box.
- P. All conduits installed in exposed areas shall be installed with a box offset before entering box.

3.2 CONDUIT INSTALLATION

- A. Cut conduit square; de-burr cut ends.

- B. Conduit shall not be fastened to the corrugated metal roof deck.
- C. Bring conduit to the shoulder of fittings and couplings and fasten securely.
- D. Use conduit hubs for fastening conduit to cast boxes. Use sealing locknuts or conduit hubs for fastening conduit to sheet metal boxes in damp or wet locations.
- E. Terminate all conduit (except for terminations into conduit bodies) using conduit hubs, or connectors with one locknut, or utilize double locknuts (one each side of box wall).
- F. Provide bushings for the ends of all conduit not terminated in box walls. Refer to Section 26 05 26 – Grounding and Bonding for Electrical Systems for grounding bushing requirements.
- G. Provide insulated bushings where raceways contain 4 AWG or larger conductors.
- H. Install no more than the equivalent of:
 - 1. Three 90 degree bends between boxes for electrical systems.
 - 2. Two 90 degree bends between boxes for communications and other low voltage systems.
 - 3. No single bend may exceed 90 degrees.
- I. Use hydraulic one-shot conduit bender or factory elbows for bends in conduit larger than 2 inch (50 mm) size unless sweep elbows are required.
- J. Bend conduit according to manufacturer's recommendations. Torches or open flame shall not be used to aid in bending of PVC conduit.
- K. Use suitable conduit caps or other approved seals to protect installed conduit against entrance of dirt and moisture.
- L. Provide 1/8 inch (3 mm) nylon pull string in empty conduit, except sleeves and nipples.
- M. Install expansion-deflection joints where conduit crosses building expansion joints. Note: expansion-deflection joints are not required where conduit crosses building control joints if the control joint does not act as an expansion joint.
- N. Install expansion joints where direct-buried conduit is subject to Earth Movement by settlement or frost per NEC 300.5(J), especially where conduit exits the ground exposed and enters a box, cabinet, or enclosure attached to a building or structure.
- O. Install expansion fitting in exterior PVC conduit runs per NEC table 352.44 utilizing a minimum temperature change of 120 degree F.

- P. Avoid moisture traps where possible. Where moisture traps are unavoidable, provide junction boxes with drain fittings at conduit low points.
- Q. Where conduit passes between areas of differing temperatures such as into or out of cool rooms, freezers, unheated and heated spaces, buildings, etc., provide conduit or box with duct seal or other means to prevent the passage of moisture and water vapor through the conduit.
- R. Route conduit through roof openings for piping and ductwork where possible.
- S. Where communication cabling is to be installed in conduit to the wiring hub (e.g. Telecom Room), multiple conduits may be consolidated into fewer, larger conduits. Capacity of shared conduits shall equal the capacity of the individual conduits unless otherwise noted.
- T. Use NRTL listed metallic grounding clamps when terminating conduit to cable tray.
- U. Ground and bond conduit under provisions of Section 26 05 26.
- V. Conduit is not permitted in any slab topping of two inches (50 mm) or less.
- W. Conduits in Concrete Slab Above Grade: Provide proposed conduit routing and sizing to Structural Engineer for approval prior to installation to verify structural integrity and fire rating of concrete slab.
- X. Maximum Size Conduit in Concrete Slabs Above Grade: 1 inch (25 mm). Do not route conduits to cross each other in slabs above grade. Minimum conduit spacing shall be 6 inches on center.
- Y. PVC conduit in concrete pole bases shall transition to galvanized rigid metal conduit 12 inches before it enters a concrete pole base. Inside the pole base, the elbow shall be galvanized rigid metal conduit. From the elbow, the conduit shall transition back to PVC as it continues up and out the top of the concrete pole base.
- Z. PVC conduit shall transition to galvanized rigid metal conduit before it enters a foundation wall or up through a concrete floor.
- AA. Identify conduit under provisions of Section 26 05 53.
- BB. All conduit installed underground (exterior to building) shall be buried a minimum of 24 inches below finished grade, whether or not the conduit is concrete encased. Install warning tape 12" below finish grade over all buried conduits. Underground warning tape shall be detectable, 2" wide minimum, 5 mil thickness, containing a foil core. Tape color shall be red and labeled with the words "CAUTION-BURIED ELECTRIC LINE BELOW" as manufactured by Presco or similar.
- CC. Conduits penetrating underground foundation walls: Individual conduits or each conduit as part of a ductbank penetrating underground foundation walls (excluding manholes) shall be sealed against water intrusion into the building.

DD. Clean PVC conduit with solvent, and dry before application of glue. The temperature rating of glue/cement shall match weather conditions. Apply full even coat of cement/glue to entire area that will be inserted into fitting. The entire installation shall meet manufacturer's recommendations.

3.3 CONDUIT INSTALLATION SCHEDULE

A. Conduit other than that specified below for specific applications shall not be used.

- Horizontal Directional Drilling (Directional Boring) Installations: HDPE conduit.
- Underground Installations That Penetrate Foundation Walls: Rigid metal conduit within five feet (1.5 m) of the foundation wall. Conduit may transition to Fiberglass Resin Conduit (BG) or PVC conduit five feet (1.5 m) from the foundation walls.
- Underground Installations That Do Not Penetrate Foundation Walls: Rigid metal conduit, Fiberglass Resin Conduit (BG), or PVC conduit.
- Underground Installations Emerging from Grade: Buried conduit emerging from grade shall be Rigid metal conduit extending from the minimum cover distance of 24 inches below grade to the conduit termination point above grade.
- Underground Installations Under Concrete Slab: Rigid metal conduit or Schedule 40 PVC conduit.
- Underground Installations Emerging through Concrete Slab: Rigid metal conduit.
- Concealed in Poured Concrete Walls: Rigid Metal Conduit, PVC conduit, or Electrical Nonmetallic Tubing (ENT).
- Concealed in Concrete Block Walls: Electrical metallic tubing, PVC conduit. Electrical Nonmetallic Tubing (ENT).
- Within Concrete Slab: Rigid Metal conduit or PVC conduit.
- Emerging from Within Concrete Slab: Rigid metal conduit.
- Exposed Outdoor Locations: Rigid metal conduit, IMC.
- Wet Interior Locations: Exposed: Rigid metal conduit, Schedule 80 PVC conduit, PVC coated rigid metal conduit, Fiberglass Resin Conduit (XW).
- Concealed Dry Interior Locations: Rigid metal conduit, Intermediate metal conduit, Electrical metallic tubing, and PVC conduit (Ground conductor).
- Interior Building Grounding Electrode Conductor: Schedule 80 PVC.
- Exposed Dry Interior Locations: Rigid metal conduit, Intermediate metal conduit, Electrical metallic tubing.
- Motor and equipment connections: Liquidtight flexible metal conduit (LFMC) (all locations). Minimum length shall be one foot (300 mm); maximum length shall be three

feet (900 mm). Conduit must be installed perpendicular to direction of equipment vibration to allow conduit to freely flex.

- Light fixtures: Refer to specification section 26 51 13.

3.4 PVC COATED RIGID METAL CONDUIT INSTALLATION

A. Installers of PVC Coated Rigid Metal Conduit shall be factory trained and certified in the proper installation methods for this type of conduit. Proof of such certification shall be kept on the project site at all times and shall be produced upon request.

3.5 HIGH DENSITY POLYETHYLENE CONDUIT (HDPE) INSTALLATION

A. HDPE conduit may only be used in horizontal directional drilling applications. Installation must be in accordance with NFPA 70 National Electrical Code and be direct buried or encased in concrete.

B. Approved joining methods for HDPE include Threaded Mechanical Fittings, Compression Fittings, and/or Heat Fusion. Heat Fusion joints shall be made using "hot irons" designed specifically for joining HDPE conduit. Any joining method employed shall be manufacturer approved. Glue and/or solvents are NOT approved.

3.6 SURFACE METAL RACEWAY INSTALLATION

A. Use flat-head screws to fasten channel to surfaces every twenty-four (24) inches. Mount plumb and level.

B. Use suitable insulating bushings and inserts at connections to outlets and corner fittings.

C. Maintain grounding continuity between raceway components to provide a continuous grounding path under provisions of Section 26 05 26.

D. Fastener Option: Use clips and straps suitable for the purpose.

3.7 NONMETALLIC SURFACE RACEWAY INSTALLATION

A. Use flat headed screws with appropriate anchors to fasten channel to surfaces secured every twenty-four (24) inches. Mount plumb and level. All surface mounted devices shall be fastened to the wall utilizing flat head screws along with appropriate anchors. No device shall be adhered to the wall surface using two-faced tape or any means other than as described above.

B. Use suitable insulating bushings and inserts at connections to outlets and corner fittings.

C. In areas where the walls cannot be fished, the station cable serving these outlets shall be covered with raceways. No exposed wire shall be permitted within offices, laboratories, and conference rooms or like facilities.

- D. Non-metallic raceway shall have a screw applied base. Both the base and cover shall be manufactured of rigid PVC materials.
- E. The raceway shall originate from a surface mounted box mounted adjacent to and at the same height as existing electrical boxes in the room, be attached to the wall and terminate above the ceiling.
- F. All fittings including, but not limited to, extension boxes, elbows, tees, fixture bodies shall match the color of the raceway.
- G. The raceway and all systems devices shall be UL listed and exhibit nonflammable self-extinguishing characteristics, tested to specifications of UL94V-0.
- H. The communications and other low voltage systems raceway and devices shall adhere to the EIA/TIA Category 6 bend radius standard.

3.8 COORDINATION OF BOX LOCATIONS

- A. Provide electrical boxes as shown on Drawings, and as required for splices, taps, wire pulling, equipment connections, and code compliance.
- B. Electrical box locations shown on Contract Drawings are approximate unless dimensioned. Verify location of floor boxes and outlets in offices and work areas prior to rough-in.
- C. No outlet, junction, or pull boxes shall be located where it will be obstructed by other equipment, piping, lockers, benches, counters, etc.
- D. Conduit and boxes shall not be fastened to the metal roof deck. If conduit and boxes are required to be located and installed on roof decks, the conduit and boxes are required to be spaced minimum 1-5/8 inch off the lowest part of the metal roof decking material, per NEC 300.4 (E).
- E. It shall be the Contractor's responsibility to study drawings pertaining to other trades, to discuss location of outlets with workmen installing other piping and equipment and to fit all electrical outlets to job conditions.
- F. In case of any question or argument over the location of an outlet, the Contractor shall refer the matter to the Architect/Engineer and install outlet as instructed by the Architect/Engineer.
- G. The proper location of each outlet is considered a part of this contract and no additional compensation will be paid to the Contractor for moving outlets which were improperly located.
- H. Locate and install boxes to allow access to them. Where installation is inaccessible, coordinate locations and provide 18 inch (450 mm) by 24 inch (600 mm) access doors. Boxes must be installed within 12" from edge of the access door.
- I. Locate and install to maintain headroom and to present a neat appearance.

- J. Install boxes to preserve fire resistance rating of partitions and other elements, using approved materials and methods.

3.9 PULL AND JUNCTION BOX INSTALLATION

- A. Pull boxes and junction boxes shall be minimum 4 inches square (100 mm) by 2 1/8 inches (54 mm) deep for use with 1 inch (25 mm) conduit and smaller. On conduit systems using 1 1/4 inch (31.75 mm) conduit, minimum junction box size shall be 4 11/16 inches square by 2 1/8 inches deep.
- B. Where used with raceway(s) containing conductors of 4 AWG or larger, pull box shall be sized as required unless otherwise noted on the drawings.
- C. Where used with raceway(s) containing conductors on systems over 600V, pull box shall be sized per NEC 314 Part IV unless otherwise noted as larger on the drawings.
- D. Locate pull boxes and junction boxes above accessible ceilings, in unfinished areas or furnish and install approved access panels in non-accessible ceilings where boxes are installed. All boxes are to be readily-accessible.
- E. Provide Pull and Junction boxes for communications and other low voltage applications (a) in any section of conduit longer than 100 feet, (b) where there are bends totaling more than 180 degrees between pull points or pull boxes and (c) wherever there is a reverse bend in run. Locate boxes on straight section of raceway (e.g. do not use boxes in place of raceway bends).
- F. Support pull and junction boxes independent of conduit.

3.10 OUTLET BOX INSTALLATION

- A. Do not install boxes back-to-back in walls. Provide minimum 6 inch (150 mm) separation, except provide minimum 24 inch (600 mm) separation in acoustic-rated walls.
- B. Power:
 - 1. Recessed (1/4 inch maximum) outlet boxes in masonry, concrete, tile construction, or drywall shall be minimum 4 inch square, with device rings. Device covers shall be square-cut except rounded corner plaster rings are allowed in drywall applications. Angle cut plaster rings are not permitted. Coordinate masonry cutting to achieve neat openings for boxes. A single gang box can be used in drywall and masonry, for a single device location, when a single conduit enters box.
 - 2. Shallow 4 inch square by 1 1/2 inch deep boxes can be used as device boxes for power provided the box and plaster ring is sized for installed device and conductors.
- C. Low Voltage:
 - 1. Recessed (1/4 inch maximum) outlet boxes in masonry, concrete, tile construction or drywall shall be minimum 4 11/16 inch square by 2 1/8 inch deep with single gang device ring (unless noted otherwise on drawings). Device covers shall be square-cut

except rounded corner plaster rings are allowed in drywall applications. Angle cut plaster rings are not permitted. Coordinate masonry cutting to achieve neat openings for boxes.

- D. Provide one conduit from each communications outlet box. Conduit runs between outlet boxes for communications are not allowed. Terminate conduit above accessible ceiling.
- E. Provide knockout closures for unused openings.
- F. Support boxes independently of conduit except for cast boxes that are connected to two rigid metal conduits, both supported within 12 inches (300 mm) of box.
- G. Use multiple-gang boxes where more than one device are mounted together; do not use sectional boxes.
- H. Install boxes in walls without damaging wall insulation.
- I. Coordinate mounting heights and locations of outlets mounted above counters, benches, and backsplashes.
- J. Ceiling outlets shall be 4 inch square, minimum 2 1/8 inch (54 mm) deep except that concrete boxes and plates will be approved where applicable. Position outlets to locate luminaires as shown on reflected ceiling plans.
- K. In inaccessible ceiling areas, position outlets and junction boxes within 6 inches (150 mm) of recessed luminaire, to be accessible through luminaire ceiling opening.
- L. Provide recessed outlet boxes in finished areas; secure boxes to interior wall and partition studs, accurately positioning to allow for surface finish thickness. Use stamped steel stud bridges for flush outlets in hollow stud wall, and adjustable steel channel fasteners for flush ceiling outlet boxes.
- M. Align wall-mounted outlet boxes for switches, thermostats, and similar devices.
- N. Provide cast ferroalloy or aluminum outlet boxes in exterior and wet locations.
- O. Surface wall outlets shall be 4 inch (100 mm) square with raised covers for one and two gang requirements. For three gang or larger requirements, use gang boxes with non-overlapping covers.

3.11 FLOOR BOX INSTALLATION

- A. Set boxes level and flush with finish flooring material.
- B. Floor boxes for communications shall each be served by conduit(s) dedicated to that box. Conduit runs between floor boxes for communications are not allowed. Conduit shall be part of path that allows for cable to be terminated at wiring hub (e.g. Telecom Room) on same floor on which floor box appears unless noted otherwise.

END OF SECTION

SECTION 26 24 16

PANELBOARDS

PART 1 GENERAL

1.1 SCOPE

- A. The work under this section includes main, distribution and branch circuit panelboards.

1.2 RELATED WORK

- A. Applicable provisions of Division 1 govern work under this Section.
- B. Section 26 43 13 - Surge Protective Devices for Low Voltage Electrical Power Circuits

1.3 REFERENCES

- A. ANSI C57.13 – Instrument Transformers
- B. NEMA AB 1 - Molded Case Circuit Breakers
- C. NEMA KS 1 - Enclosed Switches
- D. UL-891 - Dead Front Switchboards
- E. Wisconsin Administrative Code SPS 316 - Electrical

1.4 SUBMITTALS

- A. Include outline and support point dimensions, voltage, main bus ampacity, circuit breaker arrangement and sizes, and interrupting ratings confirming a fully-rated system for all equipment and components.
- B. Submit required short circuit coordination study per specification section 26 05 73 to the consulting engineer for review and approval. Submittal shall be on or before date of panelboard equipment submittal.

1.5 OPERATION AND MAINTENANCE DATA

- A. All operations and maintenance data shall comply with the submission and content requirements specified under section GENERAL REQUIREMENTS.

1.6 SPARE PARTS

- A. Keys: Furnish 2 keys for each panelboard to Owner.
- B. Handle lock-off: Furnish (2) 20/1 circuit breaker handle lock-off devices for each panelboard to Owner.
- C. One set of three spare fuses of each size and type utilized

PART 2 PRODUCTS

2.2 BRANCH CIRCUIT PANELBOARDS

- A. Lighting and Appliance Branch Circuit Panelboards: Circuit breaker type.
- B. The panelboard and overcurrent devices contained within shall be fully-rated.
- C. Enclosure: Type 1. Minimum cabinet size: 5-3/4 inches (144 mm) deep; 20 inches (508 mm) wide with 5" minimum gutter space top and bottom. Constructed of galvanized code gauge steel. Panel enclosure (back box) shall be of non-stamped type (without KO's) to avoid concentric break out problem.
- D. Cabinet front cover and cabinet shall be Type 4X, 304 stainless steel in wet and damp locations including kitchen, food service and therapeutic/pool applications.
- E. Provide surface cabinet front with concealed trim clamps, concealed hinge and flush cylinder lock all keyed alike. Front cover shall be hinged to allow access to wiring gutters without removal of panel trim. Hinged trim shall be held in place with screw fasteners. Finish in manufacturer's standard gray enamel.
- F. Provide metal directory holders with clear plastic covers.
- G. Provide panelboards with copper bus (phase buses, bus fingers, etc.), ratings as scheduled on Drawings.
- H. Provide ground bars in all panelboards. Phase, neutral and ground bar terminations can be dual rated ALCU9. All spaces shall have bus fully extended and drilled for the future installation of breakers.
- I. Incoming conductors shall terminate at lug landing pads rated for the panelboard.
- J. Provide compression type lugs to accommodate the conductor shown on drawings.
- K. Minimum System (i.e. individual component) Short Circuit Rating: As shown on the Drawings and as required by short circuit/ coordination study.
- L. Molded Case Circuit Breakers: Bolt-on type thermal magnetic trip circuit breakers. Provide UL Class A ground fault interrupter circuit breakers where shown on Drawings. Provide circuit breakers UL listed as Type HACR for air conditioning equipment branch circuits.
- M. Do not use tandem circuit breakers.
- N. Circuit breakers shall be bolt-on type with common trip handle for all poles. No handle ties of any sort will be approved.
- O. Provide a minimum of 10% spare circuit breakers in branch panelboards.
- P. All of the panelboards provided under this section shall be by the same manufacturer.
- Q. All sub-feed panelboards installed side by side shall utilize same enclosure height.

2.4 COORDINATION OF OVERCURRENT PROTECTIVE DEVICES

- A. Provide a coordination study of the electrical system and recommend set points for all of the overcurrent and ground fault trip adjustments on the equipment provided. The coordination

study and set point recommendations shall be submitted to the consulting engineer for approval. Submittal shall be on or before date of switchboard and panelboard equipment submittal. The study shall meet the requirements of specification section 26 05 73.

PART 3 EXECUTION

3.1 INSTALLATION

- A. See section 26 05 29 for support requirements.
- B. Install panelboards plumb with wall finishes.
- C. Height:
 - a. Power Distribution panelboards: Minimum 12" above finished floor and maximum of 6'-7" to center of the grip of the operating handle of the top most mounted switch or circuit breaker, when at its highest position.
 - b. Branch panelboards: 6'-0" to top of panelboard.
- D. Install a crimp type stud termination to stranded conductor when terminating on circuit breakers without a captive assembly rated for terminating stranded conductors.
- E. Provide filler plates for unused spaces in panelboards.
- F. See section 26 05 53 for identification requirements. Provide typed circuit directory for each branch circuit panelboard. Revise directory to reflect circuiting changes required to balance phase loads.
- G. Stub three (3) empty ¾" conduits to accessible location above ceiling or below floor out of each recessed panelboard. Cap these conduits to prevent material from entering them.

3.2 FIELD QUALITY CONTROL

- A. The Contractor shall circuit the panelboards as shown on the drawings. Measure steady state load currents at each panelboard feeder. Should the difference at any panelboard between phases exceed 10 percent, rearrange circuits in the panelboard to balance the phase loads within 10 percent.
- B. Visual and Mechanical Inspection: Inspect for physical damage, proper alignment, anchorage, and grounding. Check proper installation and tightness of connections.

END OF SECTION

SECTION 26 27 28

DISCONNECT SWITCHES

PART 1 GENERAL

1.1 SCOPE

- A. The work under this section includes disconnect switches, fuses and enclosures.

1.2 RELATED WORK

- A. Applicable provisions of Division 1 govern work under this Section.
- B. Section 26 27 02- Equipment Wiring Systems
- C. Section 26 27 29- Elevator Distribution Equipment

1.3 REFERENCES

- A. NECA (National Electrical Contractors Association) "Standard of Installation."
- B. NEMA ICS 2 – Industrial Control Devices, Controllers, and Assemblies.
- C. NEMA KS 1 – Enclosed Switches.
- D. UL 50 – Enclosures for Electrical Equipment.
- E. UL 98 – Enclosed and Dead-front Switches.
- F. NFPA 70 – National Electrical Code
- G. Wisconsin Administrative Code SPS 316 - Electrical

1.4 SUBMITTALS

- A. Include outline drawings with dimensions, and equipment ratings for voltage, ampacity, horsepower, and short circuit.

1.5 OPERATION AND MAINTENANCE DATA

- A. All operations and maintenance data shall comply with the submission and content requirements specified under section GENERAL REQUIREMENTS.

1.6 GENERAL

- A. Provide disconnect switches for loads required by code. Review HVAC and Plumbing specifications to determine what equipment is furnished with disconnect switches. Install disconnect switches whether furnished under this contract or not. It is the Electrical Contractors responsibility to determine the need for a disconnect switch for each load. The contractors shall include in their bid the code required disconnect switches whether indicated on the drawings or not.

PART 2 PRODUCTS

2.1 DISCONNECT SWITCHES

- A. Fusible Switch Assemblies (use only when overcurrent protection is required): NEMA Type Heavy Duty; quick-make, quick-break, load interrupter, enclosed knife switch with externally operable handle interlocked to prevent opening front cover with switch in ON position. Handle lockable in OFF position. Fuse Clips: designed to accommodate Class R, Class J or Class CC (motors) cartridge type fuses.
- B. Nonfusible Switch Assemblies: NEMA Type Heavy Duty; quick-make, quick-break, load interrupter, enclosed knife switch with externally operable handle interlocked to prevent opening front cover with switch in ON position. Handle lockable in OFF position.
- C. Enclosure:
 - 1. Outdoors: NEMA 3R code gauge zinc coated steel with baked enamel finish or NEMA 4 when indicated on drawings.
- D. Provide manufacturer's equipment ground kit in all disconnect switches.
- E. In applications where the switch serves as the service entrance disconnect, provide service ground kit, label as service disconnect and provide UL listing for service disconnect.

PART 3 EXECUTION

3.1 INSTALLATION

- A. Install disconnect switches where indicated on Drawings or required by NEC.
- B. Provide identification as specified in Section 26 05 53.
- C. Provide label on inside of disconnect cover identifying the type and size of fuse to be utilized.

END OF SECTION

SECTION 26 27 43

ELECTRIC-VEHICLE SERVICE EQUIPMENT - AC LEVEL 2

PART 1 - GENERAL

1.1 RELATED DOCUMENTS

- A. Drawings and general provisions of the Contract, including General and Supplementary Conditions and Division 01 Specification Sections, apply to this Section.

1.2 SUMMARY

- A. Section includes EVSE that provides AC Level 2 EV charging.

1.3 ACTION SUBMITTALS

- A. Product Data: For each type of product.
- B. Shop Drawings: For EVSE.
 - 1. Include plans, elevations, sections, and mounting details.
 - 2. Include details of equipment assemblies. Indicate dimensions, weights, loads, required clearances, method of field assembly, components, and location and size of each field connection.
 - 3. Detail fabrication and assembly of mounting assemblies for EV charging equipment.
 - 4. Include diagrams for power, signal, and control wiring.

1.4 INFORMATIONAL SUBMITTALS

- A. Sample warranty.

1.5 CLOSEOUT SUBMITTALS

- A. Operation and maintenance data.
- B. Software and Firmware Operational Documentation:
 - 1. Software operating manuals.
 - 2. Program Software Backup: On USB, CD, Cloud, or approved media, complete with configuration files.
 - 3. Device address and password list.
 - 4. Printout of software application and graphic screens.

1.6 QUALITY ASSURANCE

- A. Installer Qualifications: An authorized representative who is trained and approved by manufacturer.

1.7 WARRANTY

- A. Manufacturer's Warranty: Manufacturer and Installer agree to repair or replace components of EVSE that fail(s) in materials or workmanship within specified warranty period.
 - 1. Warranty Period: Five year(s) from date of Substantial Completion.

PART 2 - PRODUCTS

2.1 MANUFACTURERS

- A. Clipper Creek
- B. Source Limitations: Obtain EVSE from single manufacturer.

2.2 PERFORMANCE REQUIREMENTS

- 1. The term "withstand" means "the unit will remain in place without separation of any parts when subjected to the seismic forces specified."
- 2. Component Importance Factor: 1.0.
- B. Ambient Temperature: 5 to 104 deg F (Minus 15 to plus 40 deg C).
- C. Relative Humidity: Zero to 95 percent.
- D. Altitude: Sea level to 1000 feet (300 m).
- E. Thermal Movements: Allow for thermal movements from ambient and surface temperature changes.
- F. Surge Withstand: 6 kV at 3000 A.
- G. Electrical Components, Devices, and Accessories: Listed and labeled as defined in NFPA 70, by a qualified testing agency, and marked for intended location and use.
- H. EV Charging Levels:
 - 1. Single vehicle, AC Level 2 at up to 19.2 kW per vehicle.

2.3 EVSE DESCRIPTION

- A. Comply with NFPA 70.
- B. Comply with:
 - 1. UL 2231-1.
 - 2. UL 2594.
 - 3. SAE J1772 for SAE combo chargers.
- C. Comply with ADA-ABA Accessibility Guidelines.
- D. Metering: Nonrevenue grade meter.
- E. Control Power: 20 A, 110/120-V ac, 60 Hz, single phase per charger.
- F. Input Power:
 - 1. 45 A, 208/240-V ac, 60 Hz, single-phase services per charger.
- G. Integral GFCI.
- H. Auto-GFCI fault retry.
- I. EVSE Mounting: Pedestal mount capable of installation of two (2) chargers.
- J. Enclosures:
 - 1. Rated for environmental conditions at installed location.
 - a. Outdoor Locations: NEMA 250, Type 3R
 - b. Tamper resistant.
- K. EV Cable and Connectors:
 - 1. SAE J1772 connector.
 - 2. Single connectors with storage locking holster.
 - 3. **25-foot (8-m)** cable with cable management system.
 - 4. Field-replaceable connector and cable assembly.
- L. Status Indicators:
 - 1. LEDs to indicate power, charging, charging complete, system status, faults, and service.

PART 3 - EXECUTION

3.1 INSTALLATION

- A. Comply with NECA 1 and NECA 413.
- B. Concrete Base Mounting:

1. Install EVSE on 12-inch (300-mm) nominal-diameter and 48-inch- (1200-mm-) deep concrete base. Comply with requirements for concrete base specified in Section 033000 "Cast-in-Place Concrete."
 - C. Wiring within Enclosures: Bundle, lace, and train conductors to terminal points with no excess and without exceeding manufacturer's limitations on bending radii. Install lacing bars and distribution spools.
 - D. Disconnect: Install disconnect in a readily accessible location.
 - E. Temporary Lifting Provisions: Remove temporary lifting eyes, channels, and brackets and temporary blocking from enclosures and components.
 - F. Secure covers to enclosure.
- 3.2 CONNECTIONS
- A. Connect wiring according to Section 260519 "Low-Voltage Electrical Power Conductors and Cables."
 - B. Comply with grounding requirements in Section 260526 "Grounding and Bonding for Electrical Systems."
 - C. Comply with requirements for installation of conduit in Section 260533 "Raceways and Boxes for Electrical Systems." Drawings indicate general arrangement of conduit, fittings, and specialties.
 - D. Tighten electrical connectors and terminals according to manufacturer's published torque-tightening values. If manufacturer's torque values are not indicated, use those specified in UL 486A-486B.
 - E. Verify that all electrical connections have been made according to the manufacturer's instructions. Remove all burrs, shavings, and detritus from inside the enclosure.
 - F. After confirming all connections, install covers and tighten fasteners to according to manufacturer's instructions.

END OF SECTION 262743

SECTION 26 31 00

PHOTOVOLTAIC COLLECTORS

PART 1 - GENERAL

1.1 SUMMARY

A. Section Includes:

1. PV modules (laminates in mounting frames).
2. Inverters.

1.2 ACTION SUBMITTALS

A. Product Data: For each type of product.

B. Shop Drawings: For PV modules.

1. Include plans, elevations, sections, and mounting details.
2. Include details of equipment assemblies.
3. Include diagrams for power, signal, and control wiring.

1.3 INFORMATIONAL SUBMITTALS

A. Field quality-control reports.

B. Sample warranty.

1.4 CLOSEOUT SUBMITTALS

A. Operation and maintenance data.

1.5 WARRANTY

A. Manufacturer's Special Warranty: Manufacturer agrees to repair or replace components of PV modules that fail in materials or workmanship within specified warranty period.

1. Warranty Period: Ten years from date of Substantial Completion.

B. Manufacturer's Special Minimum Power Output Warranty: Manufacturer agrees to repair or replace components of PV modules that fail to exhibit the minimum power output within specified warranty period. Special warranty, applying to modules only, applies to materials only, on a prorated basis, for period specified.

1. Manufacturer's minimum power output warranties include, but are not limited to, the following warranty periods, from date of Substantial Completion:

- a. Specified minimum power output to 80 percent or more, for a period of 25 years.

PART 2 - PRODUCTS

2.1 PHOTOVOLTAIC MODULES

- A. Manufacturers: Subject to compliance with requirements, provide products by of the following:
 1. Heliene, Inc.
 2. Lumos Solar.
 3. Or approved Equal

2.2 PERFORMANCE REQUIREMENTS

- A. Electrical Components, Devices, and Accessories: Listed and labeled by a qualified testing agency, and marked for intended location and application.

2.3 PV SYSTEMS DESCRIPTION

- A. Interactive PV System: Collectors connected in parallel to the electrical utility; and capable of providing power for Project and supplying power to a distributed network.
 1. System Components:
 - a. PV modules.
 - b. Array frame.
 - c. Utility-interactive inverter.
 - d. Overcurrent protection and disconnect devices.
 - e. Mounting structure.
 - f. Utility meter.

2.4 MANUFACTURED PV UNITS - Lumos Solar LSX-305

- A. Cell Materials: Monocrystalline.
- B. Module Construction:
 1. Nominal Size: 41 inches (1040 mm) wide by 65.5 inches (1664 mm) long.
 2. Weight: 62.5 lb (28.4 kg).
- C. Encapsulant: Ethyl vinyl acetate.
- D. Front Panel: 0.24-inch- (6-mm-) thick FT low-iron PV glass.
- E. Backing Material: clear
- F. Junction Box:

1. Size: 1.56 by 3.96 by 0.52 inch (39.6 by 100.6 by 13.2 mm).
2. Fully potted, vandal resistant.
3. IP Code: IP67.
4. Flammability Test: UL 1703.

G. Output Cabling:

1. 0.158 inch (4 mm).
2. Quick, multiconnect, polarized connectors.
3. Two-Conductor Harness: No traditional return wire is needed from the end of a row back to the source combiner.

H. Series Fuse Rating: 15 amps.

2.5 PV CAPACITIES AND CHARACTERISTICS –

A. Minimum Electrical Characteristics:

1. Rated Open-Circuit Voltage: 40.79 V dc.
2. Maximum System Voltage: 600 V dc.
3. Maximum Power at Voltage (V_{pm}): 32.73 V dc.
4. Rated Short-Circuit Current (I_{sc}): 10.06.
5. Rated Operation Current (I_{mp}): 9.32.
6. Maximum Power at STC (P_{max}): 305.

B. Normal Operating Temperature Characteristics (NOTC):

1. Temperature at Nominal Operating Cell Temperature: 43.6 deg C.
2. Temperature Coefficient (NOTC Nominal Power): -0.453%/ deg C
3. Temperature Coefficient (NOTC Open-Circuit Voltage): -0.337%/ deg C

2.6 Temperature Coefficient (NOTC Short Circuit Current): 0.054%/ deg C

2.7 MANUFACTURED PV UNITS – Heliene

A. Cell Materials: Polycrystalline.

1. c-Si.
2. Gallium arsenide (GaAs).

B. Module Construction:

1. Nominal Size: 39.0 inches (992 mm) wide by 77.0 inches (1956 mm) long.
2. Weight: 48.28 lb (21.9 kg).

C. Encapsulant: Ethyl vinyl acetate.

D. Front Panel: 0.125-inch- (3.2-mm-) thick tempered glass.

- E. Backing Material: Tempered glass.
- F. Backing Material: 0.125-inch- (3.2-mm-) thick glass; white.
- G. Backing Material: Polyester film.
 - 1. Layers: 1.
 - 2. Color: White.
- H. Junction Box:
 - 1. Size: 1.56 by 3.96 by 0.52 inch (39.6 by 100.6 by 13.2 mm).
 - 2. Fully potted, vandal resistant.
 - 3. IP Code: IP67.
 - 4. Flammability Test: UL 1703.
- I. Output Cabling:
 - 1. 0.158 inch (4 mm).
 - 2. Quick, multiconnect, polarized connectors.
 - 3. Two-Conductor Harness: No traditional return wire is needed from the end of a row back to the source combiner.
- J. Series Fuse Rating: 15 amps.

2.8 PV CAPACITIES AND CHARACTERISTICS –

- A. Minimum Electrical Characteristics:
 - 1. Rated Open-Circuit Voltage: 46.26 V dc.
 - 2. Maximum System Voltage: 600 V dc.
 - 3. Maximum Power at Voltage (V_{pm}): 37.54 V dc.
 - 4. Rated Short-Circuit Current (I_{sc}): 9.13.
 - 5. Rated Operation Current (I_{mp}): 8.85.
 - 6. Maximum Power at STC (P_{max}): 330.
- B. Normal Operating Temperature Characteristics (NOTC):
 - 1. Temperature at Nominal Operating Cell Temperature: 45 deg C.
 - 2. Temperature Coefficient (NOTC Nominal Power): -.043%/ deg C
 - 3. Temperature Coefficient (NOTC Open-Circuit Voltage): -.032%/ deg C
 - 4. Temperature Coefficient (NOTC Short Circuit Current): 0.05%/ deg C

2.9 PV MODULE FRAMING

- A. PV laminates mounted in anodized extruded-aluminum frames.
 - 1. Entire assembly UL listed for electrical and fire safety, Class A, according to UL 1703, and complying with IEC 61215.
 - 2. Frame strength exceeding requirements of certifying agencies in subparagraph above.
 - 3. Finish: Anodized aluminum.

- a. Alloy and temper recommended by framing manufacturer for strength, corrosion resistance, and application of required finish.
- b. Color: As indicated by manufacturer's designations.

2.10 PV ARRAY CONSTRUCTION

A. Framing:

1. Material: Extruded aluminum.
2. Maximum System Weight: Less than 4 lb/sq. ft. (19.53 kg/sq. m).
3. Raceway Cover Plates: Plastic.

2.11 INVERTER

A. MANUFACTURER:

1. Fronius, Inc
2. Or Approved Equal

B. Inverter Type: Central.

C. Control Type: Maximum power point tracker control.

D. Inverter Electrical Characteristics:

1. Maximum Recommended PV Input Power: 10,000 watts and 12,000 watts.
2. Maximum Open-Circuit Voltage: 600 V dc.
3. PV Start Voltage: 270 V dc and 300 V
4. MPPT Voltage Range: 300-500 V dc.
5. Maximum Input Current: 41.5 Amps
6. Number of String Inputs: 2.
7. Number of Independent MPPT Circuits: 2.
8. Nominal Output Voltage: 208V.
9. Maximum Output Current: 27.7 amps and 33.3 amps.
10. Peak Efficiency: 97 percent.
11. CEC Weighted Efficiency: 96.5 percent.
12. DC/AC Terminal Range (AWG): 14 thru-6.
13. Communications Interface: RS 485.
14. Utility Interface: Utility-interactive inverter.

E. Operating Conditions:

1. Operating Ambient Temperatures: Minus 4 to plus 122 deg F (20 to plus 50 deg C).
2. Storage Temperature: Minus 40 to plus 122 deg F (minus 40 to plus 50 deg C).
3. Relative Humidity: Zero to 95 percent, noncondensing.

F. Charge controllers shall have the following:

1. Overcurrent protection.
2. Generator input breaker box.

3. Automatic transfer relay.
4. Digital display.
5. Transformer.
6. Disconnect switch.
7. Shunt controller.
8. Shunt regulator.
9. Surge overload protection.

G. Enclosure:

1. NEMA 250, Type 3R.
2. Enclosure Material: Galvanized steel.
3. Cooling Methods:
 - a. Passive cooling.
4. Protective Functions:
 - a. AC over/undervoltage.
 - b. AC over/underfrequency.
 - c. Ground overcurrent.
 - d. Overtemperature.
 - e. AC and dc overcurrent.
 - f. DC overvoltage.

H. Disconnects: Rated for system voltage and conductor.

I. Regulatory Approvals:

1. IEEE 1547.1.
2. IEEE 1547.3.
3. UL 1741.

PART 3 - EXECUTION

3.1 INSTALLATION

- A. Comply with NECA 1.
- B. Examine modules and array frame before installation. Reject modules and arrays that show shipping damage, are wet, are moisture damaged, or are mold damaged.
- C. Coordinate layout and installation of PV panels with support assembly and other construction.
- D. Support PV panel assemblies independent of supports for other elements such as roof and support assemblies, enclosures, vents, pipes, and conduits. Support assembly to prevent twisting from eccentric loading.
- E. Install PV inverters, in locations indicated on Drawings.

- F. Install weatherseal fittings and flanges where PV panel assemblies penetrate exterior elements such as walls or roofs. Seal around openings to make weathertight. See Section 079200 "Joint Sealants" for materials and application.
- G. Wiring Method: Install cables in raceways.
- H. Wiring within Enclosures: Bundle, lace, and train conductors to terminal points with no excess and without exceeding manufacturer's limitations on bending radii. Install lacing bars and distribution spools.

3.2 CONNECTIONS

- A. Coordinate installation of utility-interactive meter with utility.
- B. Make splices, terminations, and taps that are compatible with conductor material and that possess equivalent or better mechanical strength and insulation ratings than unspliced conductors.

END OF SECTION 263100

SECTION 31 20 00

EARTH MOVING

PART 1 - GENERAL

1.1 SUMMARY

A. Section Includes:

1. Preparing subgrades for walks, pavements, turf and grasses.
2. Excavating and backfilling for buildings and structures.
3. Subbase course for concrete walks and pavements.
4. Subbase course and base course for asphalt paving.
5. Excavating and backfilling trenches for utilities and pits for buried utility structures.

1.2 DEFINITIONS

A. Backfill: Soil material used to fill an excavation.

1. Initial Backfill: Backfill placed beside and over pipe in a trench, including haunches to support sides of pipe.
2. Final Backfill: Backfill placed over initial backfill to fill a trench.

B. Base Course: Aggregate layer placed between the subbase course and hot-mix asphalt paving.

C. Bedding Course: Aggregate layer placed over the excavated subgrade in a trench before laying pipe.

D. Borrow Soil: Satisfactory soil imported from off-site for use as fill or backfill.

E. Drainage Course: Aggregate layer supporting the slab-on-grade that also minimizes upward capillary flow of pore water.

F. Excavation: Removal of material encountered above subgrade elevations and to lines and dimensions indicated.

1. Authorized Additional Excavation: Excavation below subgrade elevations or beyond indicated lines and dimensions as directed by Architect. Authorized additional excavation and replacement material will be paid for according to Contract provisions for changes in the Work.
2. Unauthorized Excavation: Excavation below subgrade elevations or beyond indicated lines and dimensions without direction by Architect. Unauthorized excavation, as well as remedial work directed by Architect, shall be without additional compensation.

G. Fill: Soil materials used to raise existing grades.

- H. Structures: Buildings, footings, foundations, retaining walls, slabs, tanks, curbs, mechanical and electrical appurtenances, or other man-made stationary features constructed above or below the ground surface.
- I. Subbase Course: Aggregate layer placed between the subgrade and base course for hot-mix asphalt pavement, or aggregate layer placed between the subgrade and a cement concrete pavement or a cement concrete or hot-mix asphalt walk.
- J. Subgrade: Uppermost surface of an excavation or the top surface of a fill or backfill immediately below subbase, drainage fill, drainage course, or topsoil materials.
- K. Utilities: On-site underground pipes, conduits, ducts, and cables as well as underground services within buildings.

1.3 INFORMATIONAL SUBMITTALS

- A. Material test reports.

1.4 FIELD CONDITIONS

- A. Utility Locator Service: Notify utility locator service for area where Project is located before beginning earth-moving operations.

PART 2 - PRODUCTS

2.1 SOIL MATERIALS

- A. General: Provide borrow soil materials when sufficient satisfactory soil materials are not available from excavations.
- B. Satisfactory Soils: Soil Classification Groups GW, GP, GM, SW, SP, and SM according to ASTM D2487, or a combination of these groups; free of rock or gravel larger than **3 inches (75 mm)**, in any dimension, debris, waste, frozen materials, vegetation, and other deleterious matter.
- C. Unsatisfactory Soils: Soil Classification Groups GC, SC, CL, ML, OL, CH, MH, OH, and PT according to ASTM D2487, or a combination of these groups.
 - 1. Unsatisfactory soils also include satisfactory soils not maintained within 2 percent of optimum moisture content at time of compaction.
- D. Subbase Material: Naturally or artificially graded mixture of natural or crushed gravel, crushed stone, and natural or crushed sand; ASTM D2940/D2940M; with at least 90 percent passing a **1-1/2-inch (37.5-mm)** sieve and not more than 12 percent passing a **No. 200 (0.075-mm)** sieve.
- E. Base Course: Naturally or artificially graded mixture of natural or crushed gravel, crushed stone, and natural or crushed sand; ASTM D2940/D2940M; with at least 95 percent passing a **1-1/2-inch (37.5-mm)** sieve and not more than 8 percent passing a **No. 200 (0.075-mm)** sieve.

- F. Engineered Fill: Naturally or artificially graded mixture of natural or crushed gravel, crushed stone, and natural or crushed sand; ASTM D2940/D2940M; with at least 90 percent passing a 1-1/2-inch (37.5-mm) sieve and not more than 12 percent passing a No. 200 (0.075-mm) sieve.
- G. Bedding Course: Naturally or artificially graded mixture of natural or crushed gravel, crushed stone, and natural or crushed sand; ASTM D2940/D2940M; except with 100 percent passing a 1-inch (25-mm) sieve and not more than 8 percent passing a No. 200 (0.075-mm) sieve.
- H. Drainage Course: Narrowly graded mixture of washed stone, or crushed or uncrushed gravel; ASTM D448; coarse-aggregate grading Size 57; with 100 percent passing a 1-1/2-inch (37.5-mm) sieve and zero to 5 percent passing a No. 8 (2.36-mm) sieve.

2.2 ACCESSORIES

- A. Warning Tape: Acid- and alkali-resistant, polyethylene film warning tape manufactured for marking and identifying underground utilities, 6 inches (150 mm) wide and 4 mils (0.1 mm) thick, continuously inscribed with a description of the utility; colored to comply with local practice or requirements of authorities having jurisdiction.
- B. Detectable Warning Tape: Acid- and alkali-resistant, polyethylene film warning tape manufactured for marking and identifying underground utilities, a minimum of 6 inches (150 mm) wide and 4 mils (0.1 mm) thick, continuously inscribed with a description of the utility, with metallic core encased in a protective jacket for corrosion protection, detectable by metal detector when tape is buried up to 30 inches (750 mm) deep; colored to comply with local practice or requirements of authorities having jurisdiction.

PART 3 - EXECUTION

3.1 PREPARATION

- A. Protect structures, utilities, sidewalks, pavements, and other facilities from damage caused by settlement, lateral movement, undermining, washout, and other hazards created by earth-moving operations.
- B. Protect and maintain erosion and sedimentation controls during earth-moving operations.
- C. Protect subgrades and foundation soils from freezing temperatures and frost. Remove temporary protection before placing subsequent materials.

3.2 EXCAVATION, GENERAL

- A. Unclassified Excavation: Excavate to subgrade elevations regardless of the character of surface and subsurface conditions encountered. Unclassified excavated materials may include rock, soil materials, and obstructions. No changes in the Contract Sum or the Contract Time will be authorized for rock excavation or removal of obstructions.
 - 1. If excavated materials intended for fill and backfill include unsatisfactory soil materials and rock, replace with satisfactory soil materials.

3.3 EXCAVATION FOR STRUCTURES

- A. Excavate to indicated elevations and dimensions within a tolerance of plus or minus **1 inch (25 mm)**. If applicable, extend excavations a sufficient distance from structures for placing and removing concrete formwork, for installing services and other construction, and for inspections.
 - 1. Excavations for Footings and Foundations: Do not disturb bottom of excavation. Excavate by hand to final grade just before placing concrete reinforcement. Trim bottoms to required lines and grades to leave solid base to receive other work.
 - 2. Pile Foundations: Stop excavations **6 to 12 inches (150 to 300 mm)** above bottom of pile cap before piles are placed. After piles have been driven, remove loose and displaced material. Excavate to final grade, leaving solid base to receive concrete pile caps.
 - 3. Excavation for Underground Tanks, Basins, and Mechanical or Electrical Utility Structures: Excavate to elevations and dimensions indicated within a tolerance of plus or minus **1 inch (25 mm)**. Do not disturb bottom of excavations intended as bearing surfaces.
- B. Excavations at Edges of Tree- and Plant-Protection Zones:
 - 1. Excavate by hand or with an air spade to indicated lines, cross sections, elevations, and subgrades. If excavating by hand, use narrow-tine spading forks to comb soil and expose roots. Do not break, tear, or chop exposed roots. Do not use mechanical equipment that rips, tears, or pulls roots.
 - 2. Cut and protect roots according to requirements in Section 015639 "Temporary Tree and Plant Protection."

3.4 EXCAVATION FOR WALKS AND PAVEMENTS

- A. Excavate surfaces under walks and pavements to indicated lines, cross sections, elevations, and subgrades.

3.5 EXCAVATION FOR UTILITY TRENCHES

- A. Excavate trenches to indicated gradients, lines, depths, and elevations.
- B. Excavate trenches to uniform widths to provide the following clearance on each side of pipe or conduit. Excavate trench walls vertically from trench bottom to **12 inches (300 mm)** higher than top of pipe or conduit unless otherwise indicated.
 - 1. Clearance: **12 inches (300 mm)** each side of pipe or conduit.
- C. Trench Bottoms: Excavate and shape trench bottoms to provide uniform bearing and support of pipes and conduit. Shape subgrade to provide continuous support for bells, joints, and barrels of pipes and for joints, fittings, and bodies of conduits. Remove projecting stones and sharp objects along trench subgrade.
 - 1. Excavate trenches **6 inches (150 mm)** deeper than elevation required in rock or other unyielding bearing material to allow for bedding course.

D. Trenches in Tree- and Plant-Protection Zones:

1. Hand-excavate to indicated lines, cross sections, elevations, and subgrades. Use narrow-tine spading forks to comb soil and expose roots. Do not break, tear, or chop exposed roots. Do not use mechanical equipment that rips, tears, or pulls roots.
2. Do not cut main lateral roots or taproots; cut only smaller roots that interfere with installation of utilities.
3. Cut and protect roots according to requirements in Section 015639 "Temporary Tree and Plant Protection."

3.6 UNAUTHORIZED EXCAVATION

- A. Fill unauthorized excavation under foundations or wall footings by extending bottom elevation of concrete foundation or footing to excavation bottom, without altering top elevation. Lean concrete fill, with 28-day compressive strength of **2500 psi (17.2 MPa)**, may be used when approved by Architect.
1. Fill unauthorized excavations under other construction, pipe, or conduit as directed by Architect.

3.7 STORAGE OF SOIL MATERIALS

- A. Stockpile borrow soil materials and excavated satisfactory soil materials without intermixing. Place, grade, and shape stockpiles to drain surface water. Cover to prevent windblown dust.
1. Stockpile soil materials away from edge of excavations. Do not store within drip line of remaining trees.

3.8 UTILITY TRENCH BACKFILL

- A. Place backfill on subgrades free of mud, frost, snow, or ice.
- B. Place and compact bedding course on trench bottoms and where indicated. Shape bedding course to provide continuous support for bells, joints, and barrels of pipes and for joints, fittings, and bodies of conduits.
- C. Trenches under Footings: Backfill trenches excavated under footings and within **18 inches (450 mm)** of bottom of footings with satisfactory soil; fill with concrete to elevation of bottom of footings. Concrete is specified in Section 033000 "Cast-in-Place Concrete."
- D. Trenches under Roadways: Provide **4-inch (100-mm)** thick, concrete-base slab support for piping or conduit less than **30 inches (750 mm)** below surface of roadways. After installing and testing, completely encase piping or conduit in a minimum of **4 inches (100 mm)** of concrete before backfilling or placing roadway subbase course. Concrete is specified in Section 033000 "Cast-in-Place Concrete."
- E. Initial Backfill: Place and compact initial backfill of subbase material and/or satisfactory soil, free of particles larger than **1 inch (25 mm)**, in any dimension, to a height of **12 inches (300 mm)** over the pipe or conduit.

1. Carefully compact initial backfill under pipe haunches and compact evenly up on both sides and along the full length of piping or conduit to avoid damage or displacement of piping or conduit. Coordinate backfilling with utilities testing.
- F. Final Backfill: Place and compact final backfill of satisfactory soil to final subgrade elevation.
- G. Warning Tape: Install warning tape directly above utilities, **12 inches (300 mm)** below finished grade, except **6 inches (150 mm)** below subgrade under pavements and slabs.

3.9 SOIL FILL

- A. Plow, scarify, bench, or break up sloped surfaces steeper than 1 vertical to 4 horizontal so fill material will bond with existing material.
- B. Place and compact fill material in layers to required elevations as follows:
1. Under grass and planted areas, use satisfactory soil material.
 2. Under walks and pavements, use satisfactory soil material.
 3. Under steps and ramps, use engineered fill.
 4. Under future shelter pads, use engineered fill.
 5. Under footings and foundations, use engineered fill.

3.10 SOIL MOISTURE CONTROL

- A. Uniformly moisten or aerate subgrade and each subsequent fill or backfill soil layer before compaction to within 2 percent of optimum moisture content.
1. Do not place backfill or fill soil material on surfaces that are muddy, frozen, or contain frost or ice.
 2. Remove and replace, or scarify and air dry, otherwise satisfactory soil material that exceeds optimum moisture content by 2 percent and is too wet to compact to specified dry unit weight.

3.11 COMPACTION OF SOIL BACKFILLS AND FILLS

- A. Place backfill and fill soil materials in layers not more than **8 inches (200 mm)** in loose depth for material compacted by heavy compaction equipment and not more than **4 inches (100 mm)** in loose depth for material compacted by hand-operated tampers.
- B. Place backfill and fill soil materials evenly on all sides of structures to required elevations and uniformly along the full length of each structure.
- C. Compact soil materials to not less than the following percentages of maximum dry unit weight according to ASTM D698:
1. Under future shelter pads and pavements, scarify and recompact top **12 inches (300 mm)** of existing subgrade and each layer of backfill or fill soil material at 92 percent.
 2. Under walkways, scarify and recompact top **6 inches (150 mm)** below subgrade and compact each layer of backfill or fill soil material at 92 percent.

3. Under turf or unpaved areas, scarify and recompact top 6 inches (150 mm) below subgrade and compact each layer of backfill or fill soil material at 85 percent.
4. For utility trenches, compact each layer of initial and final backfill soil material at 85 percent.

3.12 GRADING

- A. General: Uniformly grade areas to a smooth surface, free of irregular surface changes. Comply with compaction requirements and grade to cross sections, lines, and elevations indicated.
- B. Site Rough Grading: Slope grades to direct water away from buildings and to prevent ponding. Finish subgrades to elevations required to achieve indicated finish elevations, within the following subgrade tolerances:
 1. Turf or Unpaved Areas: Plus or minus 1 inch (25 mm).
 2. Walks: Plus or minus 1 inch (25 mm).
 3. Pavements: Plus or minus 1/2 inch (13 mm).

3.13 SUBBASE AND BASE COURSES UNDER PAVEMENTS AND WALKS

- A. Place subbase course and base course on subgrades free of mud, frost, snow, or ice.
- B. On prepared subgrade, place subbase course and base course under pavements and walks as follows:
 1. Place subbase course and base course that exceeds 6 inches (150 mm) in compacted thickness in layers of equal thickness, with no compacted layer more than 6 inches (150 mm) thick or less than 3 inches (75 mm) thick.
 2. Compact subbase course and base course at optimum moisture content to required grades, lines, cross sections, and thickness to not less than 92 percent of maximum dry unit weight according to ASTM D698 and ASTM D1557.

3.14 DRAINAGE COURSE UNDER CONCRETE SLABS-ON-GRADE

- A. Place drainage course on subgrades free of mud, frost, snow, or ice.
- B. On prepared subgrade, place and compact drainage course under cast-in-place concrete slabs-on-grade as follows:
 1. Place drainage course that exceeds 6 inches (150 mm) in compacted thickness in layers of equal thickness, with no compacted layer more than 6 inches (150 mm) thick or less than 3 inches (75 mm) thick.
 2. Compact each layer of drainage course to required cross sections and thicknesses to not less than 92 percent of maximum dry unit weight according to ASTM D698.

3.15 FIELD QUALITY CONTROL

- A. Special Inspections: Owner will engage a qualified special inspector to perform inspections:

- B. Testing Agency: Owner will engage a qualified geotechnical engineering testing agency to perform tests and inspections.
- C. Allow testing agency to inspect and test subgrades and each fill or backfill layer. Proceed with subsequent earth moving only after test results for previously completed work comply with requirements.
- D. Footing Subgrade: At footing subgrades, at least one test of each soil stratum will be performed to verify design bearing capacities. Subsequent verification and approval of other footing subgrades may be based on a visual comparison of subgrade with tested subgrade when approved by Architect.
- E. When testing agency reports that subgrades, fills, or backfills have not achieved degree of compaction specified, scarify and moisten or aerate, or remove and replace soil materials to depth required; recompact and retest until specified compaction is obtained.

3.16 PROTECTION

- A. Protecting Graded Areas: Protect newly graded areas from traffic, freezing, and erosion. Keep free of trash and debris.
- B. Repair and reestablish grades to specified tolerances where completed or partially completed surfaces become eroded, rutted, settled, or where they lose compaction due to subsequent construction operations or weather conditions.
- C. Where settling occurs before Project correction period elapses, remove finished surfacing, backfill with additional soil material, compact, and reconstruct surfacing.
 - 1. Restore appearance, quality, and condition of finished surfacing to match adjacent work, and eliminate evidence of restoration to greatest extent possible.

3.17 DISPOSAL OF SURPLUS AND WASTE MATERIALS

- A. Remove surplus satisfactory soil and waste materials, including unsatisfactory soil, trash, and debris, and legally dispose of them off Owner's property.

END OF SECTION 312000

SECTION 32 12 16

ASPHALT PAVING

PART 1 - GENERAL

1.1 SUMMARY

A. Section Includes:

1. Hot-mix asphalt paving.
2. Hot-mix asphalt overlay.
3. Cold milling of existing asphalt pavement.
4. Hot-mix asphalt patching.
5. Asphalt curbs.

B. Related Requirements:

1. Section 312000 "Earth Moving" for subgrade preparation, fill material, separation geotextiles, unbound-aggregate subbase and base courses, and aggregate pavement shoulders.
2. Section 321313 "Concrete Paving" for concrete pavement and for separate concrete curbs, gutters, and driveway aprons.

1.2 ACTION SUBMITTALS

A. Hot-mix asphalt designs.

1.3 INFORMATIONAL SUBMITTALS

A. Material Certificates:

1. Aggregates.
2. Asphalt binder.
3. Tack coat.

1.4 QUALITY ASSURANCE

A. Regulatory Requirements: Comply with materials, workmanship, and other applicable requirements of Dane County, Wisconsin Public Works Department, for asphalt paving work.

1. Measurement and payment provisions and safety program submittals included in standard specifications do not apply to this Section.

PART 2 - PRODUCTS

2.1 AGGREGATES

- A. Coarse Aggregate: ASTM D692/D692M, sound; angular crushed stone, crushed gravel, or cured, crushed blast-furnace slag.
- B. Fine Aggregate: ASTM D1073, sharp-edged natural sand or sand prepared from stone, gravel, cured blast-furnace slag, or combinations thereof.
- C. Mineral Filler: ASTM D242/D242M, rock or slag dust, hydraulic cement, or other inert material.

2.2 ASPHALT MATERIALS

- A. Asphalt Binder: ASTM D6373 binder designation PG 58-28.
- B. Asphalt Cement: ASTM D3381/D3381M for viscosity-graded material or ASTM D946/D946M for penetration-graded material.
- C. Tack Coat: ASTM D977 emulsified asphalt, or ASTM D2397/D2397M cationic emulsified asphalt, slow setting, diluted in water, of suitable grade and consistency for application.

2.3 MIXES

- A. Hot-Mix Asphalt: Dense-graded, hot-laid, hot-mix asphalt plant mixes approved by Dane County Parks and Public Works Departments.

PART 3 - EXECUTION

3.1 COLD MILLING

- A. Clean existing pavement surface of loose and deleterious material immediately before cold milling. Remove existing asphalt pavement by cold milling to grades and cross sections indicated.
 - 1. Mill to a depth of 1-1/2 inches (38 mm).
 - 2. Patch surface depressions deeper than 1 inch (25 mm) after milling, before wearing course is laid.

3.2 PATCHING

- A. Asphalt Pavement: Saw cut perimeter of patch and excavate existing pavement section to sound base. Excavate rectangular or trapezoidal patches, extending 12 inches (300 mm) into perimeter of adjacent sound pavement, unless otherwise indicated. Cut excavation faces vertically.

Remove excavated material. Recompact existing unbound-aggregate base course to form new subgrade.

- B. Portland cement Concrete Pavement: Break cracked slabs and roll as required to reseal concrete pieces firmly.
 - 1. Remove disintegrated or badly cracked pavement. Excavate rectangular or trapezoidal patches, extending into perimeter of adjacent sound pavement, unless otherwise indicated. Cut excavation faces vertically. Recompact existing unbound-aggregate base course to form new subgrade.
- C. Tack Coat: Before placing patch material, apply tack coat uniformly to vertical asphalt surfaces abutting the patch. Apply at a rate of **0.05 to 0.15 gal./sq. yd. (0.2 to 0.7 L/sq. m)**.
 - 1. Allow tack coat to cure undisturbed before applying hot-mix asphalt paving.
 - 2. Avoid smearing or staining adjoining surfaces, appurtenances, and surroundings. Remove spillages and clean affected surfaces.
- D. Placing Patch Material: Fill excavated pavement areas with hot-mix asphalt base mix for full thickness of patch and, while still hot, compact flush with adjacent surface.

3.3 SURFACE PREPARATION

- A. Ensure that prepared subgrade is ready to receive paving. Immediately before placing asphalt materials, remove loose and deleterious material from substrate surfaces.
- B. Tack Coat: Apply uniformly to surfaces of existing pavement at a rate of **0.05 to 0.15 gal./sq. yd. (0.2 to 0.7 L/sq. m)**.
 - 1. Allow tack coat to cure undisturbed before applying hot-mix asphalt paving.
 - 2. Avoid smearing or staining adjoining surfaces, appurtenances, and surroundings. Remove spillages and clean affected surfaces.

3.4 HOT-MIX ASPHALT PLACEMENT

- A. Machine place hot-mix asphalt on prepared surface, spread uniformly, and strike off. Place asphalt mix by hand in areas inaccessible to equipment in a manner that prevents segregation of mix. Place each course to required grade, cross section, and thickness when compacted.
 - 1. Place hot-mix asphalt base course and binder course in number of lifts and thicknesses as required by Dane County PW Dept.
 - 2. Place hot-mix asphalt surface course in single lift.
 - 3. Spread mix at a minimum temperature of **250 deg F (121 deg C)**.
 - 4. Regulate paver machine speed to obtain smooth, continuous surface free of pulls and tears in asphalt-paving mat.
- B. Place paving in consecutive strips not less than **10 feet (3 m)** wide unless infill edge strips of a lesser width are required.

- C. Promptly correct surface irregularities in paving course behind paver. Use suitable hand tools to remove excess material forming high spots. Fill depressions with hot-mix asphalt to prevent segregation of mix; use suitable hand tools to smooth surface.

3.5 JOINTS

- A. Construct joints to ensure a continuous bond between adjoining paving sections. Construct joints free of depressions, with same texture and smoothness as other sections of hot-mix asphalt course.
 - 1. Clean contact surfaces and apply tack coat to joints.
 - 2. Offset longitudinal joints, in successive courses, a minimum of **6 inches (150 mm)**.
 - 3. Offset transverse joints, in successive courses, a minimum of **24 inches (600 mm)**.
 - 4. Construct transverse joints at each point where paver ends a day's work and resumes work at a subsequent time. Construct these joints using either "bulkhead" or "papered" method in accordance with AI MS-22, for both "Ending a Lane" and "Resumption of Paving Operations."

3.6 COMPACTION

- A. General: Begin compaction as soon as placed hot-mix paving will bear roller weight without excessive displacement. Compact hot-mix paving with hot hand tampers or with vibratory-plate compactors in areas inaccessible to rollers.
 - 1. Complete compaction before mix temperature cools to **185 deg F (85 deg C)**.
- B. Breakdown Rolling: Complete breakdown or initial rolling immediately after rolling joints and outside edge. Examine surface immediately after breakdown rolling for indicated crown, grade, and smoothness. Correct laydown and rolling operations to comply with requirements.
- C. Intermediate Rolling: Begin intermediate rolling immediately after breakdown rolling while hot-mix asphalt is still hot enough to achieve specified density. Continue rolling until hot-mix asphalt course has been uniformly compacted to the following density:
 - 1. Average Density, Rice Test Method: 92 percent of reference maximum theoretical density in accordance with ASTM D2041/D2041M, but not less than 90 percent or greater than 96 percent.
- D. Finish Rolling: Finish roll paved surfaces to remove roller marks while hot-mix asphalt is still warm.
- E. Edge Shaping: While surface is being compacted and finished, trim edges of pavement to proper alignment. Bevel edges while asphalt is still hot; compact thoroughly.
- F. Protection: After final rolling, do not permit vehicular traffic on pavement until it has cooled and hardened.
- G. Erect barricades to protect paving from traffic until mixture has cooled enough not to become marked.

3.7 ASPHALT CURBS

- A. Construct hot-mix asphalt curbs over compacted pavement surfaces. Apply a light tack coat unless pavement surface is still tacky and free from dust. Spread hot-mix asphalt at a minimum temperature of 250 deg F (121 deg C).
 - 1. Hot-Mix Asphalt: Same as pavement surface-course mix.
- B. Place hot-mix asphalt to curb cross section indicated or, if not indicated, to local standard shapes, by machine or by hand in wood or metal forms. Tamp hand-placed materials and screed to smooth finish. Remove forms after hot-mix asphalt has cooled.

3.8 INSTALLATION TOLERANCES

- A. Pavement Thickness: Compact each course to produce thickness indicated within the following tolerances:
 - 1. Base Course and Binder Course: Plus or minus 1/2 inch (13 mm).
 - 2. Surface Course: Plus 1/4 inch (6 mm), no minus.
- B. Pavement Surface Smoothness: Compact each course to produce surface smoothness within the following tolerances as determined by using a 10-foot (3-m) straightedge applied transversely or longitudinally to paved areas:
 - 1. Base Course and Binder Course: 1/4 inch (6 mm).
 - 2. Surface Course: 1/8 inch (3 mm).
 - 3. Crowned Surfaces: Test with crowned template centered and at right angle to crown. Maximum allowable variance from template is 1/4 inch (6 mm).

3.9 FIELD QUALITY CONTROL

- A. Testing Agency: Owner will engage a qualified testing agency to perform tests and inspections.
- B. Replace and compact hot-mix asphalt where core tests were taken.
- C. Remove and replace or install additional hot-mix asphalt where test results or measurements indicate that it does not comply with specified requirements.

3.10 WASTE HANDLING

- A. General: Handle asphalt-paving waste in accordance with approved waste management plan required in Section 017419 "Construction Waste Management and Disposal."

END OF SECTION 321216

SECTION 321313
CONCRETE PAVING

PART 1 - GENERAL

1.1 SUMMARY

A. Section Includes Concrete Paving:

1. Driveways.
2. Parking lots.
3. Curbs and gutters.
4. Walks.

1.2 ACTION SUBMITTALS

A. Product Data: For each type of product.

B. Design Mixtures: For each concrete paving mixture. Include alternate design mixtures when characteristics of materials, Project conditions, weather, test results, or other circumstances warrant adjustments.

1.3 QUALITY ASSURANCE

A. Ready-Mix-Concrete Manufacturer Qualifications: A firm experienced in manufacturing ready-mixed concrete products and that complies with ASTM C94/C94M requirements for production facilities and equipment.

1. Manufacturer certified according to NRMCA's "Certification of Ready Mixed Concrete Production Facilities" (Quality Control Manual - Section 3, "Plant Certification Checklist").

1.4 PRECONSTRUCTION TESTING

A. Preconstruction Testing Service: Engage a qualified independent testing agency to perform preconstruction testing on concrete paving mixtures.

PART 2 - PRODUCTS

2.1 CONCRETE, GENERAL

A. ACI Publications: Comply with **ACI 301** (**ACI 301M**) unless otherwise indicated.

2.2 CONCRETE MATERIALS

- A. Cementitious Materials: Use the following cementitious materials, of same type, brand, and source throughout Project:
 - 1. Portland cement: ASTM C150/C150M, white portland cement Type I.
 - 2. Fly Ash: ASTM C618, Class C.
 - 3. Slag Cement: ASTM C989/C989M, Grade 100 or 120.
- B. Normal-Weight Aggregates: ASTM C33/C33M, Class 4S, uniformly graded. Provide aggregates from a single source.
- C. Air-Entraining Admixture: ASTM C260/C260M.
- D. Chemical Admixtures: Admixtures certified by manufacturer to be compatible with other admixtures and to contain not more than 0.1 percent water-soluble chloride ions by mass of cementitious material.
- E. Water: Potable and complying with ASTM C94/C94M.

2.3 CURING MATERIALS

- A. Absorptive Cover: AASHTO M 182, Class 3, burlap cloth made from jute or kenaf, weighing approximately 9 oz./sq. yd. (305 g/sq. m) dry or cotton mats.
- B. Moisture-Retaining Cover: ASTM C171, polyethylene film or white burlap-polyethylene sheet.
- C. Water: Potable.

2.4 RELATED MATERIALS

- A. Joint Fillers: ASTM D1751, asphalt-saturated cellulosic fiber in preformed strips.
- B. Slip-Resistive Aggregate Finish: Factory-graded, packaged, rustproof, nonglazing, abrasive aggregate of fused aluminum-oxide granules or crushed emery aggregate containing not less than 50 percent aluminum oxide and not less than 20 percent ferric oxide; unaffected by freezing, moisture, and cleaning materials.

2.5 CONCRETE MIXTURES

- A. Prepare design mixtures, proportioned according to ACI 301 (ACI 301M), for each type and strength of normal-weight concrete, and as determined by either laboratory trial mixtures or field experience.
- B. Cementitious Materials: Use fly ash, pozzolan, slag cement, and silica fume as needed to reduce the total amount of portland cement, which would otherwise be used, by not less than 40 percent.

1. Fly Ash or Pozzolan: 25 percent.
 2. Slag Cement: 50 percent.
 3. Combined Fly Ash or Pozzolan, and Slag Cement: 50 percent, with fly ash or pozzolan not exceeding 25 percent.
- C. Add air-entraining admixture at manufacturer's prescribed rate to result in normal-weight concrete at point of placement having an air content as follows:
1. Air Content: 6 percent plus or minus 1-1/2 percent.
- D. Chemical Admixtures: Use admixtures according to manufacturer's written instructions.
- E. Synthetic Fiber: Uniformly disperse in concrete mixture at manufacturer's recommended rate, but not less than 1.0 lb./cu. yd. (0.60 kg/cu. m).
- F. Color Pigment: Add color pigment to concrete mixture according to manufacturer's written instructions and to result in hardened concrete color consistent with approved mockup.
- G. Concrete Mixtures: Normal-weight concrete.
1. Compressive Strength (28 Days): 3500 psi (24.1 MPa).
 2. Maximum W/C Ratio at Point of Placement: 0.45.
 3. Slump Limit: 4 inches (100 mm), plus or minus 1 inch (25 mm).

2.6 CONCRETE MIXING

- A. Ready-Mixed Concrete: Measure, batch, and mix concrete materials and concrete according to ASTM C94/C94M. Furnish batch certificates for each batch discharged and used in the Work.

PART 3 - EXECUTION

3.1 EXAMINATION

- A. Proof-roll prepared subbase surface below concrete paving to identify soft pockets and areas of excess yielding.

3.2 PREPARATION

- A. Remove loose material from compacted subbase surface immediately before placing concrete.

3.3 EDGE FORMS AND SCREED CONSTRUCTION

- A. Set, brace, and secure edge forms, bulkheads, and intermediate screed guides to required lines, grades, and elevations. Install forms to allow continuous progress of work and so forms can remain in place at least 24 hours after concrete placement.

- B. Clean forms after each use and coat with form-release agent to ensure separation from concrete without damage.

3.4 STEEL REINFORCEMENT INSTALLATION

- A. Comply with CRSI's "Manual of Standard Practice" for fabricating, placing, and supporting reinforcement.

3.5 JOINTS

- A. General: Form construction, isolation, and contraction joints and tool edges true to line, with faces perpendicular to surface plane of concrete. Construct transverse joints at right angles to centerline unless otherwise indicated.
- B. Construction Joints: Set construction joints at side and end terminations of paving and at locations where paving operations are stopped for more than one-half hour unless paving terminates at isolation joints.
- C. Isolation Joints: Form isolation joints of preformed joint-filler strips abutting concrete curbs, catch basins, manholes, inlets, structures, other fixed objects, and where indicated.
- D. Contraction Joints: Form weakened-plane contraction joints, sectioning concrete into areas as indicated. Construct contraction joints for a depth equal to at least one-fourth of the concrete thickness or to match jointing of existing adjacent concrete paving.
- E. Edging: After initial floating, tool edges of paving, gutters, curbs, and joints in concrete with an edging tool to a 1/4-inch (6-mm) radius. Repeat tooling of edges after applying surface finishes.

3.6 CONCRETE PLACEMENT

- A. Moisten subbase to provide a uniform dampened condition at time concrete is placed. Do not place concrete around manholes or other structures until they are at required finish elevation and alignment.
- B. Comply with ACI 301 (ACI 301M) requirements for measuring, mixing, transporting, and placing concrete.
- C. Deposit and spread concrete in a continuous operation between transverse joints. Do not push or drag concrete into place or use vibrators to move concrete into place.
- D. Screed paving surface with a straightedge and strike off.
- E. Commence initial floating using bull floats or darbies to impart an open-textured and uniform surface plane before excess moisture or bleedwater appears on the surface. Do not further disturb concrete surfaces before beginning finishing operations or spreading surface treatments.

3.7 FLOAT FINISHING

- A. General: Do not add water to concrete surfaces during finishing operations.
- B. Float Finish: Begin the second floating operation when bleedwater sheen has disappeared and concrete surface has stiffened sufficiently to permit operations. Float surface with power-driven floats or by hand floating if area is small or inaccessible to power units. Finish surfaces to true planes. Cut down high spots and fill low spots. Refloat surface immediately to uniform granular texture.
 - 1. Burlap Finish: Drag a seamless strip of damp burlap across float-finished concrete, perpendicular to line of traffic, to provide a uniform, gritty texture.
 - 2. Medium-to-Fine-Textured Broom Finish: Draw a soft-bristle broom across float-finished concrete surface, perpendicular to line of traffic, to provide a uniform, fine-line texture.
 - 3. Medium-to-Coarse-Textured Broom Finish: Provide a coarse finish by striating float-finished concrete surface **1/16 to 1/8 inch (1.6 to 3 mm)** deep with a stiff-bristled broom, perpendicular to line of traffic.
- C. Slip-Resistive Aggregate Finish: Before final floating, spread slip-resistive aggregate finish on paving surface according to manufacturer's written instructions.
 - 1. Cure concrete with curing compound recommended by slip-resistive aggregate manufacturer. Apply curing compound immediately after final finishing.
 - 2. After curing, lightly work surface with a steel-wire brush or abrasive stone and water to expose nonslip aggregate.

3.8 CONCRETE PROTECTION AND CURING

- A. General: Protect freshly placed concrete from premature drying and excessive cold or hot temperatures.
- B. Comply with ACI 306.1 for cold-weather protection.
- C. Evaporation Retarder: Apply evaporation retarder to concrete surfaces if hot, dry, or windy conditions cause moisture loss approaching **0.2 lb./sq. ft. x h (1 kg/sq. m x h)** before and during finishing operations. Apply according to manufacturer's written instructions after placing, screeding, and bull floating or darbying concrete but before float finishing.
- D. Begin curing after finishing concrete but not before free water has disappeared from concrete surface.
- E. Curing Methods: Cure concrete by moisture curing, moisture-retaining-cover curing [curing compound or a combination of these.

3.9 PAVING TOLERANCES

- A. Comply with tolerances in **ACI 117 (ACI 117M)** and as follows:
 - 1. Elevation: **3/4 inch (19 mm)**.

2. Thickness: Plus $\frac{3}{8}$ inch (10 mm), minus $\frac{1}{4}$ inch (6 mm).
3. Surface: Gap below 10-feet- (3-m-) long; unlevelled straightedge not to exceed $\frac{1}{2}$ inch (13 mm).
4. Joint Spacing: 3 inches (75 mm).
5. Contraction Joint Depth: Plus $\frac{1}{4}$ inch (6 mm), no minus.
6. Joint Width: Plus $\frac{1}{8}$ inch (3 mm), no minus.

3.10 REPAIR AND PROTECTION

- A. Remove and replace concrete paving that is broken, damaged, or defective or that does not comply with requirements in this Section. Remove work in complete sections from joint to joint unless otherwise approved by Architect.
- B. Protect concrete paving from damage. Exclude traffic from paving for at least 14 days after placement. When construction traffic is permitted, maintain paving as clean as possible by removing surface stains and spillage of materials as they occur.
- C. Maintain concrete paving free of stains, discoloration, dirt, and other foreign material. Sweep paving not more than two days before date scheduled for Substantial Completion inspections.

END OF SECTION 321313

PHOTOVOLTAIC SYSTEMS

LUSSIER FAMILY HERITAGE CENTER & LAKE FARM CAMPGROUND

MADISON, WISCONSIN

CONSTRUCTION DOCUMENTS

MARCH 16, 2020

COUNTY OF DANE RFB NO 320010

CONSULTANTS

ISSUED

12/20/2019 SD DOCUMENTS

3/16/2020 CD DOCUMENTS

REVISIONS / ADDENDA

-	
-	
-	
-	
-	

PROJECT #: 320010

DRAWN: --

CHECKED: --

DATE: 16 March, 2020

PHASE: CD

PROJECT

PV INSTALLATION AND DESIGN
LUSSIER FAMILY HERITAGE
CENTER AND LAKE
FARM CAMPGROUND
3101 LAKE FARM ROAD
MADISON, WISCONSIN

TITLE SHEET

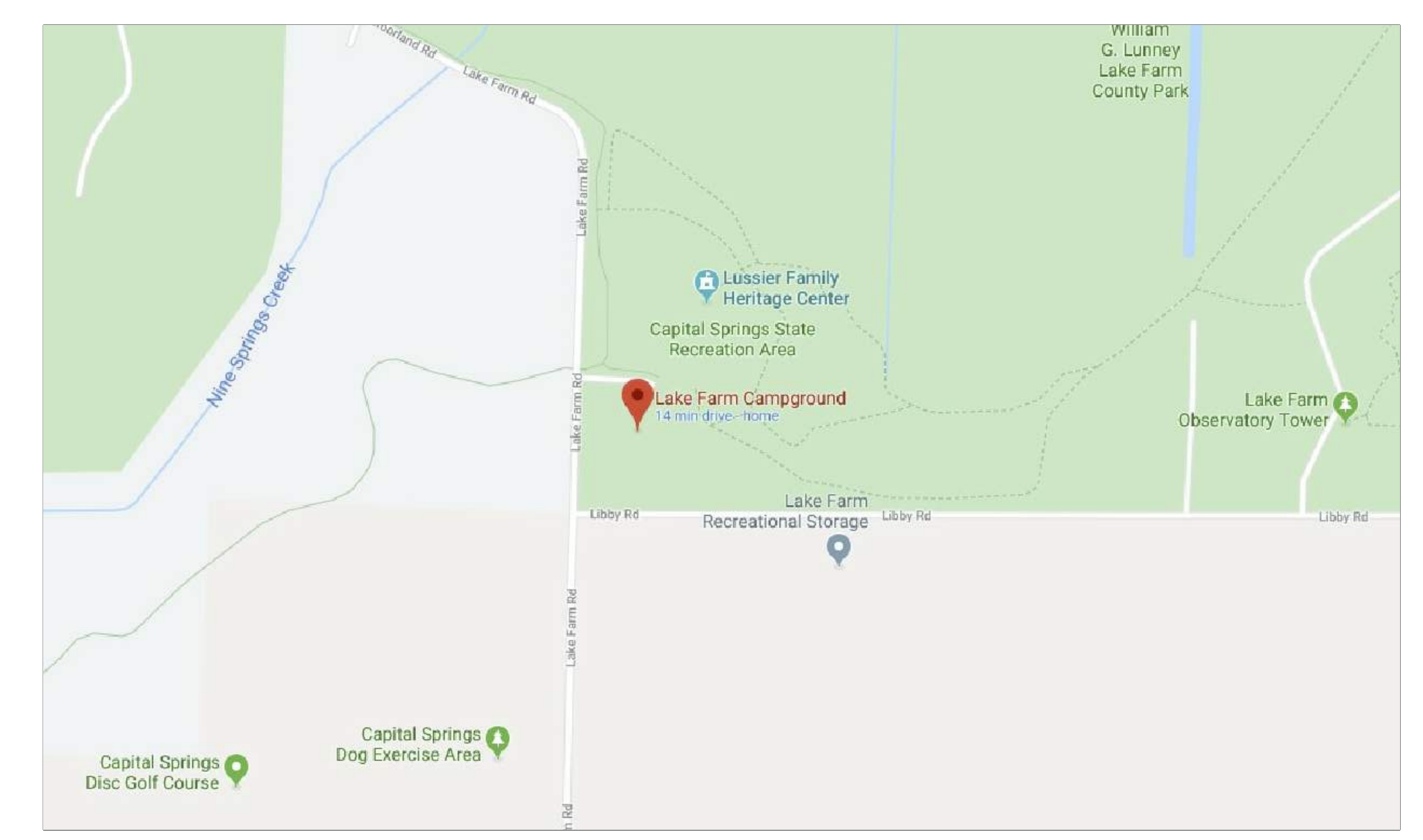
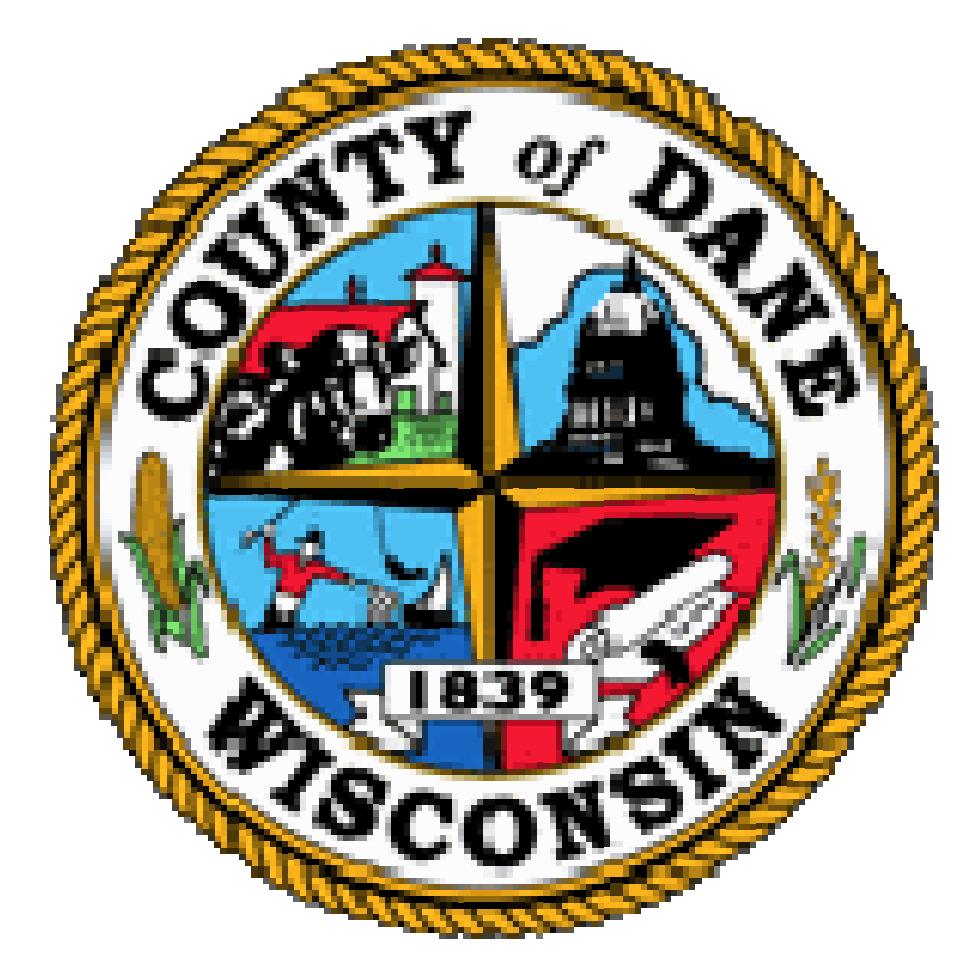
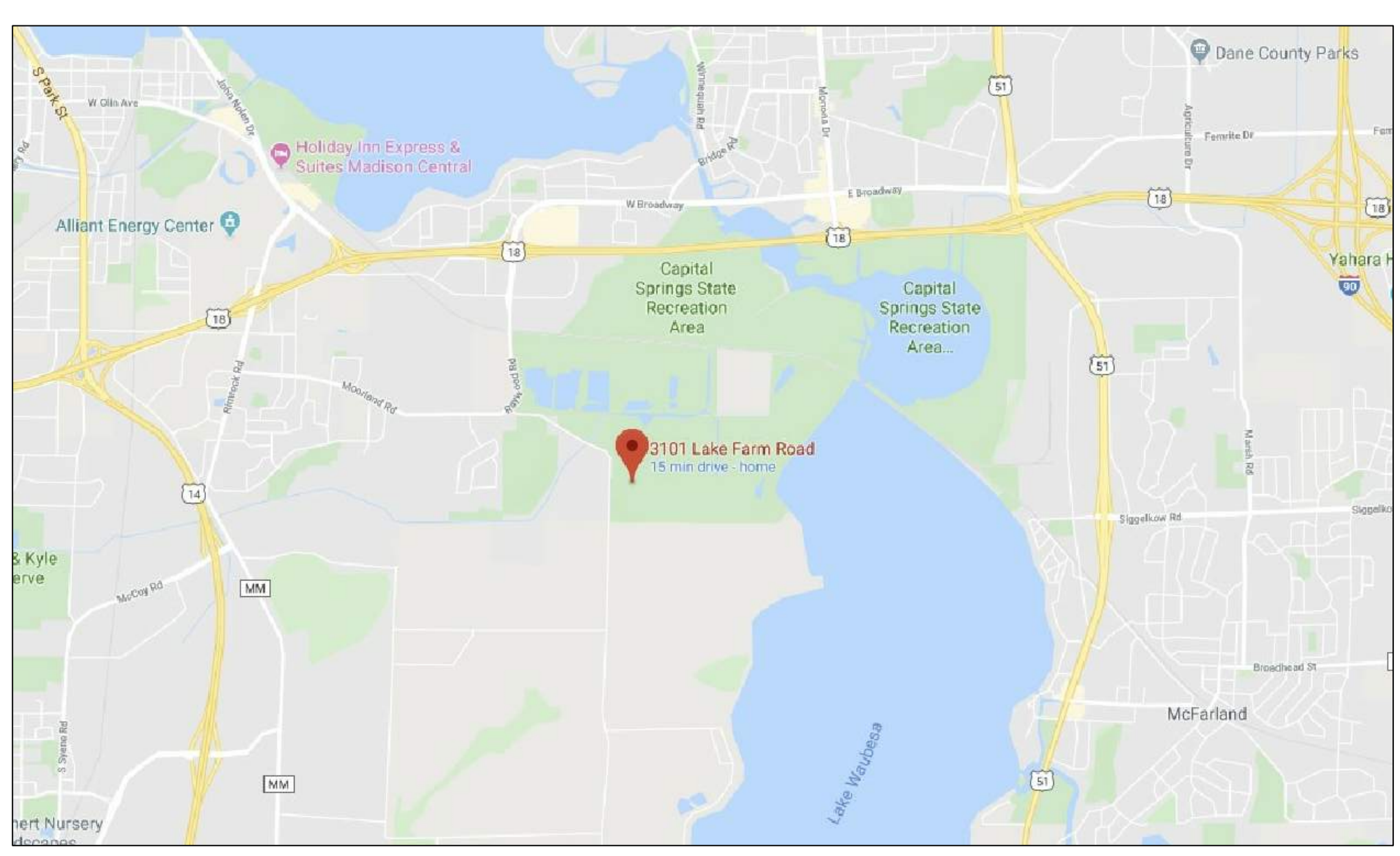

3101 LAKE FARM ROAD

MADISON, WISCONSIN 53711

SHEET INDEX

T100	TITLE SHEET
C001	HERITAGE CENTER AND LAKE FARM CAMPGROUND - OVERALL CIVIL SITE PLAN
C101	LUSSIER FAMILY HERITAGE CENTER - CIVIL SITE PLAN
C102	LAKE FARM CAMPGROUND - CIVIL SITE PLAN
C201	HERITAGE CENTER - CIVIL SITE PLAN
C202	LAKE FARM CAMPGROUND - CIVIL SITE PLAN
S000	STRUCTURAL INDEX, LEGENDS, AND SPECIFICATIONS
S101	FOUNDATION AND ROOF FRAMING PLAN
S301	DETAILS
E001	SCHEDULES, ABBREVIATIONS AND LEGEND
E101	LUSSIER FAMILY HERITAGE CENTER - ELECTRICAL SITE PLAN
E102	LAKE FARM CAMPGROUND - ELECTRICAL SITE PLAN
E201	HERITAGE CENTER ELECTRICAL PLANS
E202	LAKE FARM CAMPGROUND ELECTRICAL PLANS
E301	SHELTER ELEVATIONS
E401	LUSSIER FAMILY HERITAGE CENTER - ELECTRICAL ONE-LINE DIAGRAM
E402	LAKE FARM CAMPGROUND - ELECTRICAL ONE-LINE DIAGRAM

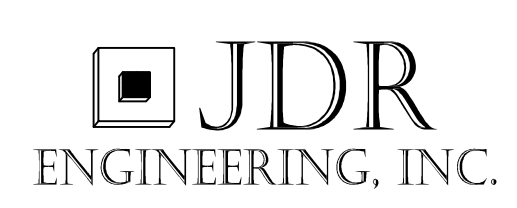

ELECTRICAL
JDR ENGINEERING, INC.
5525 NOBEL DRIVE SUITE 110
MADISON, WI 53711
PHONE : 608-277-1728
JDR PROJECT NO. : 19.0217



CIVIL/STRUCTURAL
DC ENGINEERING, INC
7601 GANSER WAY. SUITE 202
MADISON, WI 53719
PHONE: 608-416-1041

CONSULTANTS



ISSUED

12/20/2019 SD DOCUMENTS

2/16/2020 CD DOCUMENTS

REVISIONS / ADDENDA

-	
-	
-	
-	
-	

PROJECT #: 320010

DRAWN: JRH

CHECKED: SW

DATE: 16 March, 2020

PHASE: CD

PROJECT
PV INSTALLATION AND DESIGN
LUSSIER FAMILY HERITAGE
CENTER AND LAKE FARM
CAMPGROUND
3101 LAKE FARM ROAD
MADISON, WISCONSIN

HERITAGE CENTER
AND LAKE FARM
CAMPGROUND
OVERALL CIVIL
SITE PLAN

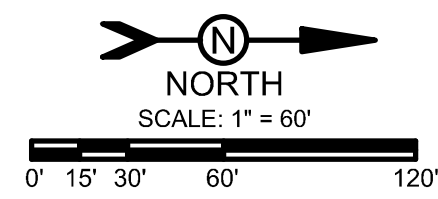

LEGEND	
OH	OVERHEAD UTILITY WIRE
CG	BURIED GAS LINE
WM	WATER MAIN
SSM	SANITARY SEWER
ST	STORM SEWER
BT	BURIED TELEPHONE
EC	BURIED ELECTRIC
UTV	BURIED CABLE ACCESS TELEVISION LINE
FO	BURIED FIBER OPTIC
PI	PROPOSED STORM INLET
ST	PROPOSED STORM SEWER
CT	PROPOSED CONTOURS
x	PROPOSED SPOT ELEVATIONS

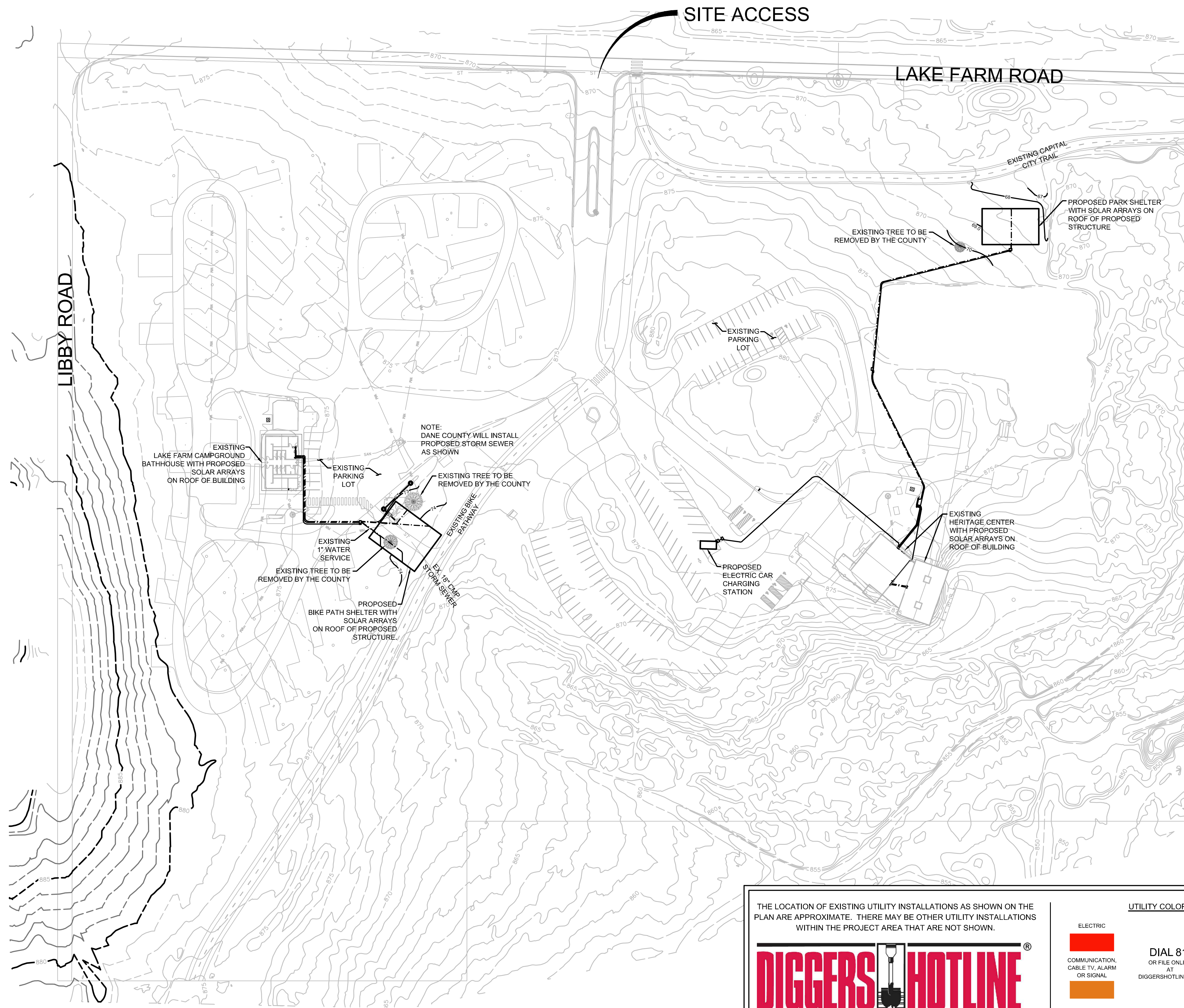

THE LOCATION OF EXISTING UTILITY INSTALLATIONS AS SHOWN ON THE PLAN ARE APPROXIMATE. THERE MAY BE OTHER UTILITY INSTALLATIONS WITHIN THE PROJECT AREA THAT ARE NOT SHOWN.

DIGGERS HOTLINE
TO OBTAIN LOCATION OF PARTICIPANTS' UNDERGROUND FACILITIES BEFORE YOU DIG IN WISCONSIN: DIAL 811 OR FILE ONLINE AT DIGGERSHOTLINE.COM
WIS. STATUTE 182.0175 REQUIRES MIN. OF 3 WORK DAYS NOTICE BEFORE YOU EXCAVATE.

UTILITY COLOR CODE		
ELECTRIC	DIAL 811 OR FILE ONLINE AT DIGGERSHOTLINE.COM	GAS, OIL, PETROLEUM OR GASEOUS MATERIALS
COMMUNICATION, CABLE TV, ALARM OR SIGNAL		WATER, IRRIGATION AND SLURRY LINES
SEWER AND DRAIN LINES	PROPOSED EXCAVATION	TEMPORARY SURVEY MARKINGS



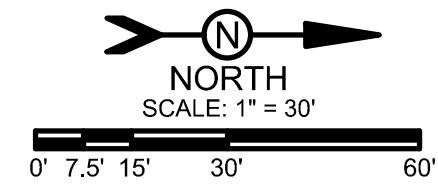

LEGEND	
	OVERHEAD UTILITY WIRE
	BURIED GAS LINE
	WATER MAIN
	SANITARY SEWER
	STORM SEWER
	BURIED TELEPHONE
	BURIED ELECTRIC
	BURIED CABLE ACCESS TELEVISION LINE
	BURIED FIBER OPTIC
	PROPOSED STORM INLET
	PROPOSED STORM SEWER
	PROPOSED CONTOURS
	PROPOSED SPOT ELEVATIONS

NOTES:

- 1 CONTRACTOR IS RESPONSIBLE FOR EXCAVATION, INSTALLING SHELTER FOUNDATION AND BACKFILLING. DANE COUNTY WILL INSTALL GRAVEL PADS AND COMPLETE GENERAL GRADING AND SITE LANDSCAPING RESTORATION.
- 2 CONTRACTOR IS RESPONSIBLE FOR TRENCHING, ELECTRICAL CONDUIT INSTALLATION AND BACKFILLING.
- 3 CONTRACTOR MAY OPEN CUT TRENCHES ACROSS PAVEMENT, AND REMOVE AND REPLACE PAVEMENT SECTION IN LIKE AND KIND OR CONTRACTOR MAY USE BORE DRILLING FOR INSTALLING CONDUITS UNDER PAVED SURFACES.
- 4 BOLLARDS ARE TO BE INSTALLED BY CONTRACTOR ON EACH SIDE AND ONE FOOT AWAY FROM CAR CHARGER, AT THE EDGE OF THE PAVEMENT.

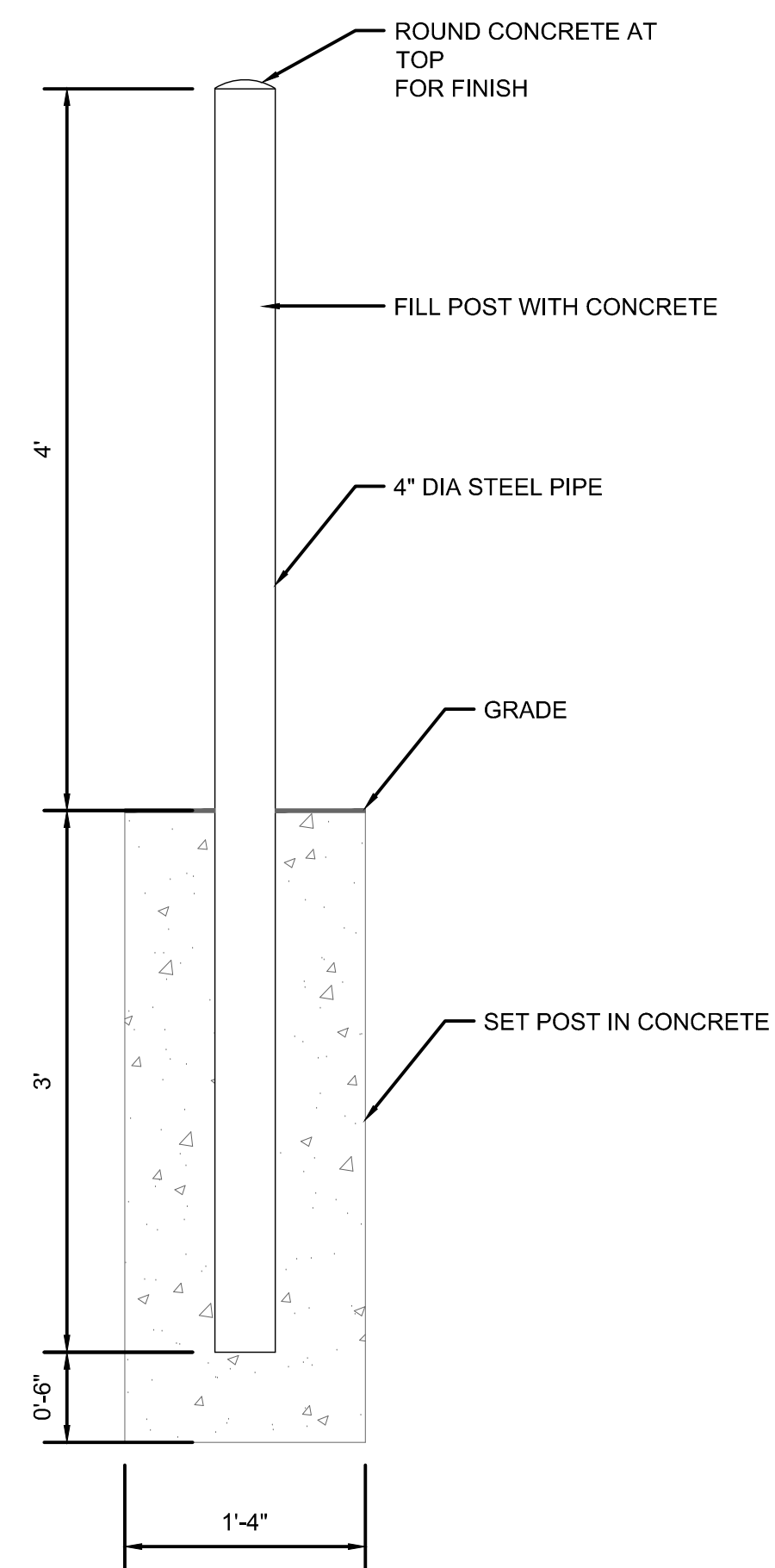

2 PIPE BOLLARD DETAIL
C101 SCALE: NTS

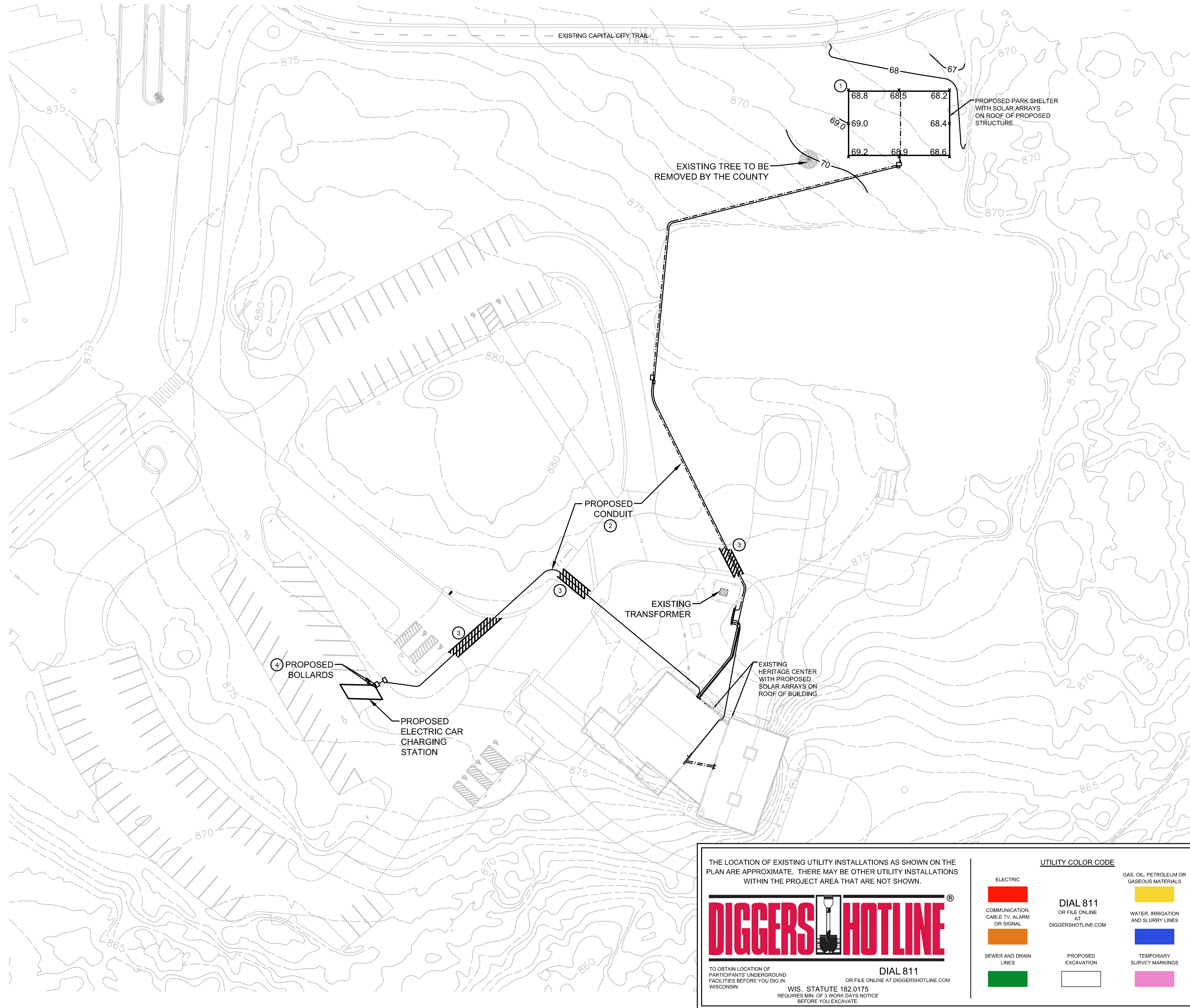

1 LUSSIER FAMILY HERITAGE CENTER - CIVIL SITE PLAN
C101 SCALE: 1" = 30'

THE LOCATION OF EXISTING UTILITY INSTALLATIONS AS SHOWN ON THE PLAN ARE APPROXIMATE. THERE MAY BE OTHER UTILITY INSTALLATIONS WITHIN THE PROJECT AREA THAT ARE NOT SHOWN.

DIGGERS HOTLINE[®]

TO OBTAIN LOCATION OF PARTICIPANTS' UNDERGROUND FACILITIES BEFORE YOU DIG IN WISCONSIN: DIAL 811 OR FILE ONLINE AT DIGGERSHOTLINE.COM

WIS. STATUTE 182.0175
REQUIRES MIN. OF 3 WORK DAYS NOTICE BEFORE YOU EXCAVATE.

UTILITY COLOR CODE			
	ELECTRIC		GAS, OIL, PETROLEUM OR GASEOUS MATERIALS
	COMMUNICATION, CABLE TV, ALARM OR SIGNAL		WATER, IRRIGATION AND SLURRY LINES
	SEWER AND DRAIN LINES		PROPOSED EXCAVATION
			TEMPORARY SURVEY MARKINGS

CONSULTANTS



ISSUED

12/20/2019 SD DOCUMENTS

2/16/2020 CD DOCUMENTS

REVISIONS / ADDENDA

PROJECT #: 320010

DRAWN: JRH

CHECKED: SW

DATE: 16 March, 2020

PHASE: CD

PROJECT
PV INSTALLATION AND DESIGN
LUSSIER FAMILY HERITAGE
CENTER AND LAKE
FARM CAMPGROUND
3101 LAKE FARM ROAD
MADISON, WISCONSIN

LUSSIER FAMILY
HERITAGE CENTER -
CIVIL SITE PLAN



CONSULTANTS



ISSUED

12/20/2019 SD DOCUMENTS

2/16/2020 CD DOCUMENTS

REVISIONS / ADDENDA

-	
-	
-	
-	
-	

PROJECT #: 320010

DRAWN: JRH

CHECKED: SW

DATE: 16 March, 2020

PHASE: CD

PROJECT
PV INSTALLATION AND DESIGN
LUSSIER FAMILY HERITAGE
CENTER AND LAKE
FARM CAMPGROUND
3101 LAKE FARM ROAD
MADISON, WISCONSIN

LAKE FARM
CAMPGROUND -
CIVIL SITE PLAN

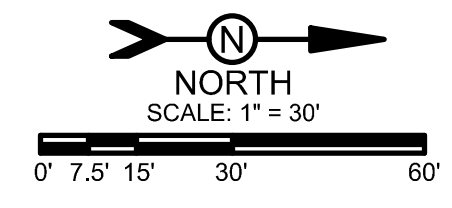

LEGEND	
— OH —	OVERHEAD UTILITY WIRE
— B —	BURIED GAS LINE
— W —	WATER MAIN
— SAN —	SANITARY SEWER
— ST —	STORM SEWER
— UT —	BURIED TELEPHONE
— E —	BURIED ELECTRIC
— TV —	BURIED CABLE ACCESS TELEVISION LINE
— FO —	BURIED FIBER OPTIC
⊙	PROPOSED STORM INLET
ST	PROPOSED STORM SEWER
— 87 —	PROPOSED CONTOURS
x	PROPOSED SPOT ELEVATIONS

- NOTES:**
- CONTRACTOR IS RESPONSIBLE FOR EXCAVATION, INSTALLING SHELTER FOUNDATION AND BACKFILLING. DANE COUNTY WILL INSTALL GRAVEL PADS AND COMPLETE GENERAL GRADING AND SITE LANDSCAPING RESTORATION.
 - CONTRACTOR IS RESPONSIBLE FOR TRENCHING, ELECTRICAL CONDUIT INSTALLATION AND BACKFILLING.
 - CONTRACTOR MAY OPEN CUT TRENCHES ACROSS PAVEMENT, AND REMOVE AND REPLACE PAVEMENT SECTION IN LIKE AND KIND OR CONTRACTOR MAY USE BORE DRILLING FOR INSTALLING CONDUITS UNDER PAVED SURFACES.

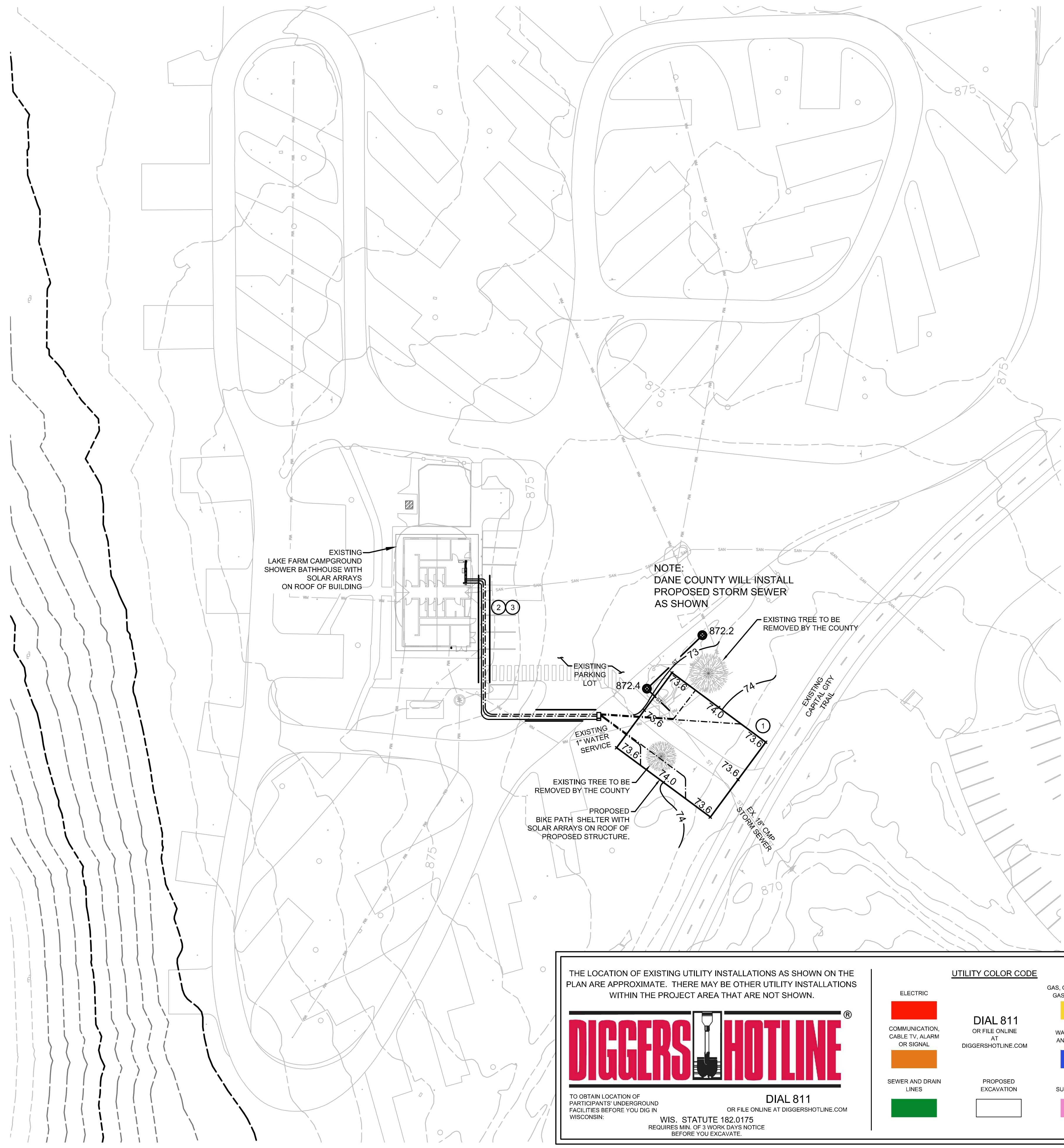

THE LOCATION OF EXISTING UTILITY INSTALLATIONS AS SHOWN ON THE PLAN ARE APPROXIMATE. THERE MAY BE OTHER UTILITY INSTALLATIONS WITHIN THE PROJECT AREA THAT ARE NOT SHOWN.

TO OBTAIN LOCATION OF PARTICIPANTS' UNDERGROUND FACILITIES BEFORE YOU DIG IN WISCONSIN: DIAL 811 OR FILE ONLINE AT DIGGERSHOTLINE.COM WIS. STATUTE 182.0175 REQUIRES MIN. OF 3 WORK DAYS NOTICE BEFORE YOU EXCAVATE.

UTILITY COLOR CODE		
ELECTRIC	DIAL 811 OR FILE ONLINE AT DIGGERSHOTLINE.COM	GAS, OIL, PETROLEUM OR GASEOUS MATERIALS
COMMUNICATION, CABLE TV, ALARM OR SIGNAL		WATER, IRRIGATION AND SLURRY LINES
SEWER AND DRAIN LINES	PROPOSED EXCAVATION	TEMPORARY SURVEY MARKINGS

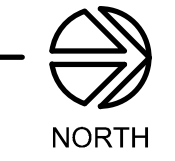

CONSULTANTS



ISSUED

12/20/2019 SD DOCUMENTS

2/16/2020 CD DOCUMENTS

REVISIONS / ADDENDA

PROJECT # : 320010

DRAWN : JRH

CHECKED : SW

DATE : 16 March, 2020

PHASE : CD

PROJECT
PV INSTALLATION AND DESIGN
LUSSIER FAMILY HERITAGE
CENTER AND LAKE
FARM CAMPGROUND
3101 LAKE FARM ROAD
MADISON, WISCONSIN

HERITAGE CENTER
CIVIL SITE PLAN

C201

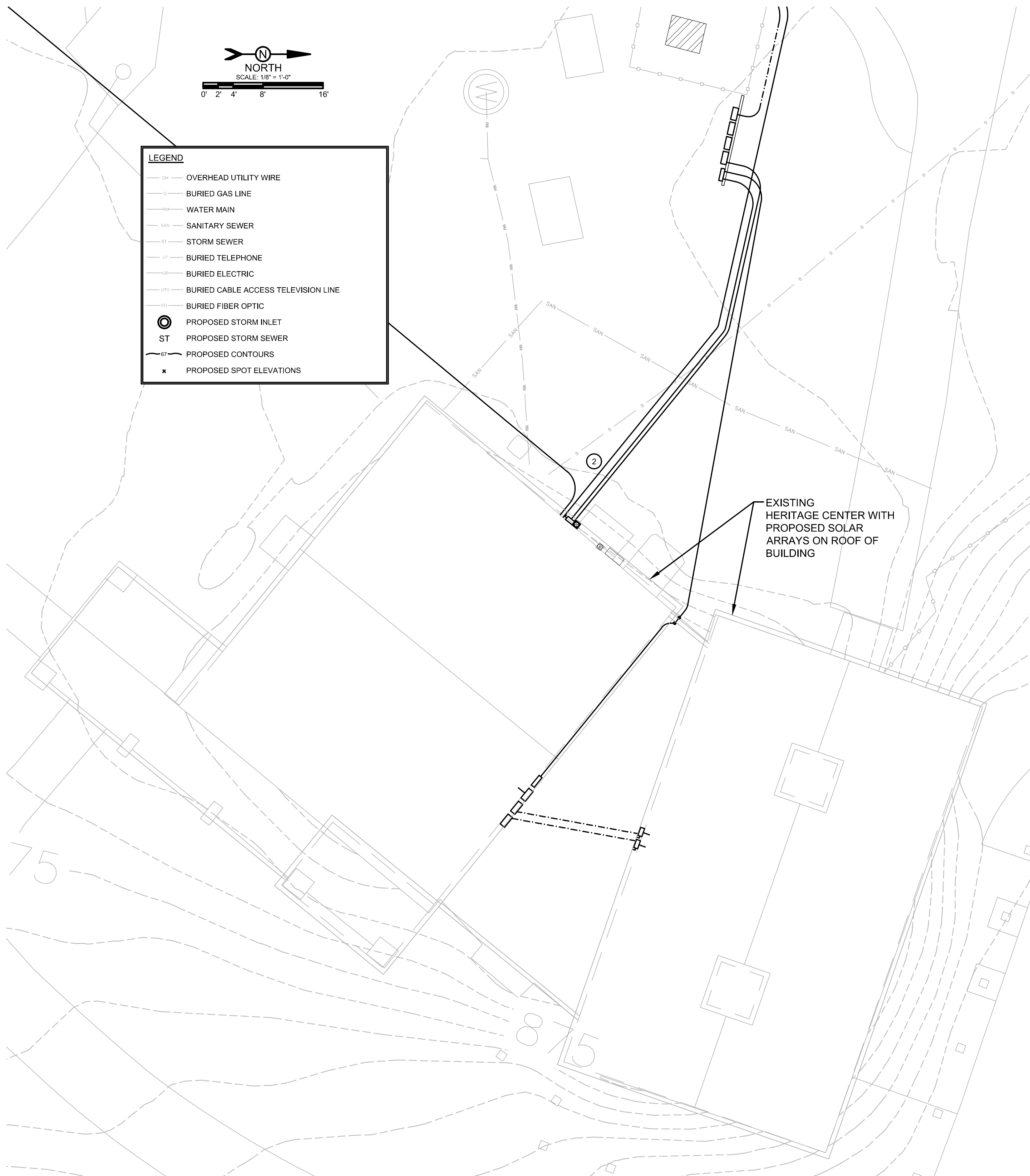

2 HERITAGE CENTER - CIVIL SITE PLAN
C201 SCALE: 1/8" = 1'-0"

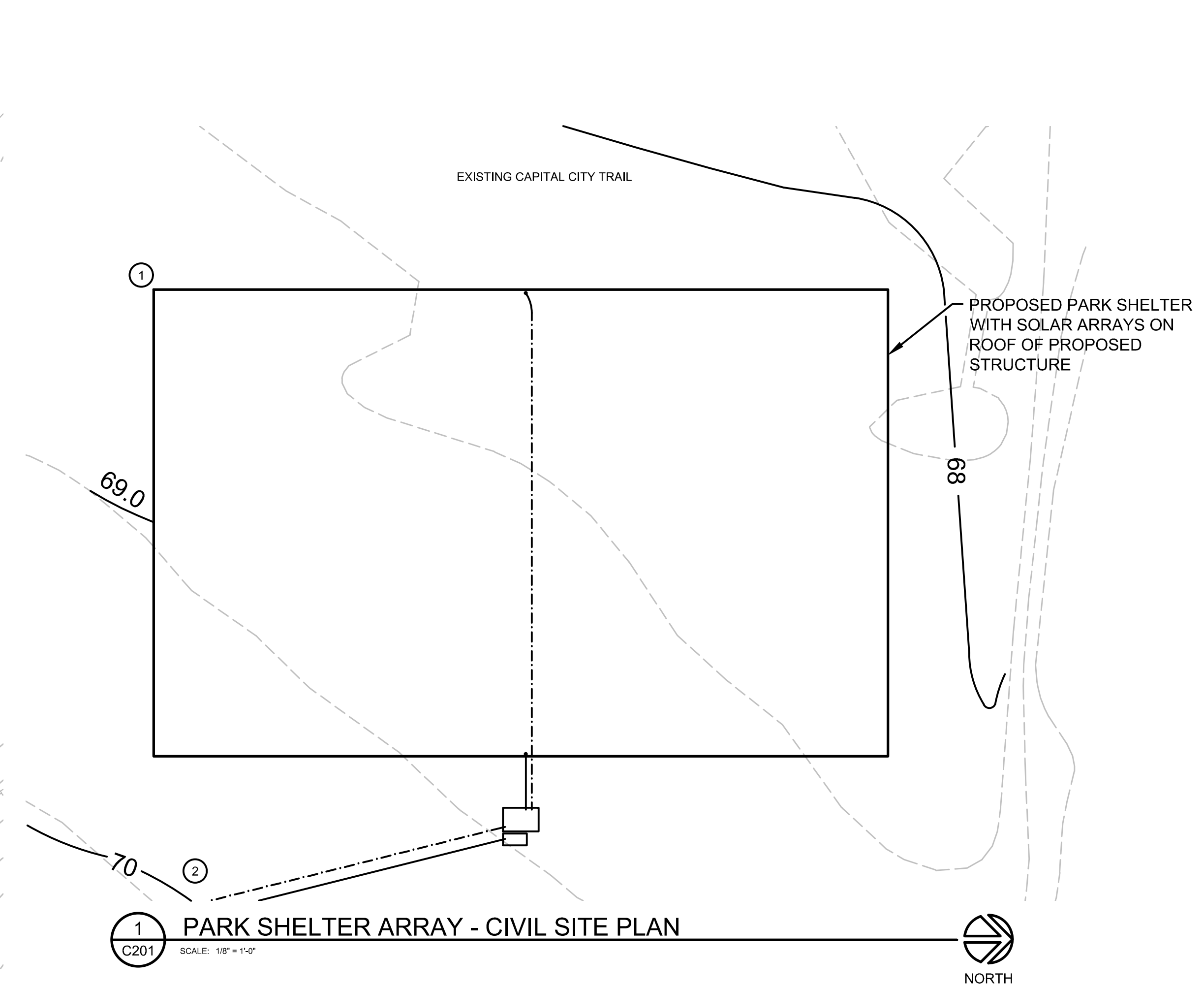

1 PARK SHELTER ARRAY - CIVIL SITE PLAN
C201 SCALE: 1/8" = 1'-0"



- NOTES:**
- CONTRACTOR IS RESPONSIBLE FOR EXCAVATION, INSTALLING SHELTER FOUNDATION AND BACKFILLING. DANE COUNTY WILL INSTALL GRAVEL PADS AND COMPLETE GENERAL GRADING AND SITE LANDSCAPING RESTORATION.
 - CONTRACTOR IS RESPONSIBLE FOR TRENCHING, ELECTRICAL CONDUIT INSTALLATION AND BACKFILLING.
 - CONTRACTOR MAY OPEN CUT TRENCHES ACROSS PAVEMENT, AND REMOVE AND REPLACE PAVEMENT SECTION IN LIKE AND KIND OR CONTRACTOR MAY USE BORE DRILLING FOR INSTALLING CONDUITS UNDER PAVED SURFACES.

THE LOCATION OF EXISTING UTILITY INSTALLATIONS AS SHOWN ON THE PLAN ARE APPROXIMATE. THERE MAY BE OTHER UTILITY INSTALLATIONS WITHIN THE PROJECT AREA THAT ARE NOT SHOWN.

DIGGERS HOTLINE
DIAL 811
OR FILE ONLINE AT DIGGERSHOTLINE.COM

TO OBTAIN LOCATION OF PARTICIPANTS' UNDERGROUND FACILITIES BEFORE YOU DIG IN WISCONSIN:
WIS. STATUTE 182.0175
REQUIRES MIN. OF 3 WORK DAYS NOTICE BEFORE YOU EXCAVATE.

UTILITY COLOR CODE

ELECTRIC	COMMUNICATION, CABLE TV, ALARM OR SIGNAL	SEWER AND DRAIN LINES	PROPOSED EXCAVATION	GAS, OIL, PETROLEUM OR GASEOUS MATERIALS	WATER, IRRIGATION AND SLURRY LINES	TEMPORARY SURVEY MARKINGS
[Red Box]	[Orange Box]	[Green Box]	[White Box]	[Yellow Box]	[Blue Box]	[Pink Box]

1 PARK SHELTER ARRAY - CIVIL SITE PLAN
C201 SCALE: 1/8" = 1'-0"

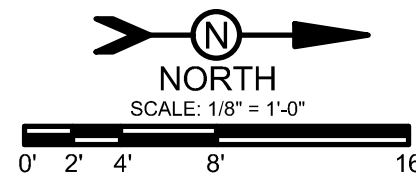

LEGEND

- OVERHEAD UTILITY WIRE
- BURIED GAS LINE
- WATER MAIN
- SANITARY SEWER
- STORM SEWER
- BURIED TELEPHONE
- BURIED ELECTRIC
- BURIED CABLE ACCESS TELEVISION LINE
- BURIED FIBER OPTIC
- PROPOSED STORM INLET
- ST PROPOSED STORM SEWER
- PROPOSED CONTOURS
- x PROPOSED SPOT ELEVATIONS

- NOTES:**
- 1 CONTRACTOR IS RESPONSIBLE FOR EXCAVATION, INSTALLING SHELTER FOUNDATION AND BACKFILLING. DANE COUNTY WILL INSTALL GRAVEL PADS AND COMPLETE GENERAL GRADING AND SITE LANDSCAPING RESTORATION.
 - 2 CONTRACTOR IS RESPONSIBLE FOR TRENCHING, ELECTRICAL CONDUIT INSTALLATION AND BACKFILLING.
 - 3 CONTRACTOR MAY OPEN CUT TRENCHES ACROSS PAVEMENT, AND REMOVE AND REPLACE PAVEMENT SECTION IN LIKE AND KIND OR CONTRACTOR MAY USE BORE DRILLING FOR INSTALLING CONDUITS UNDER PAVED SURFACES.

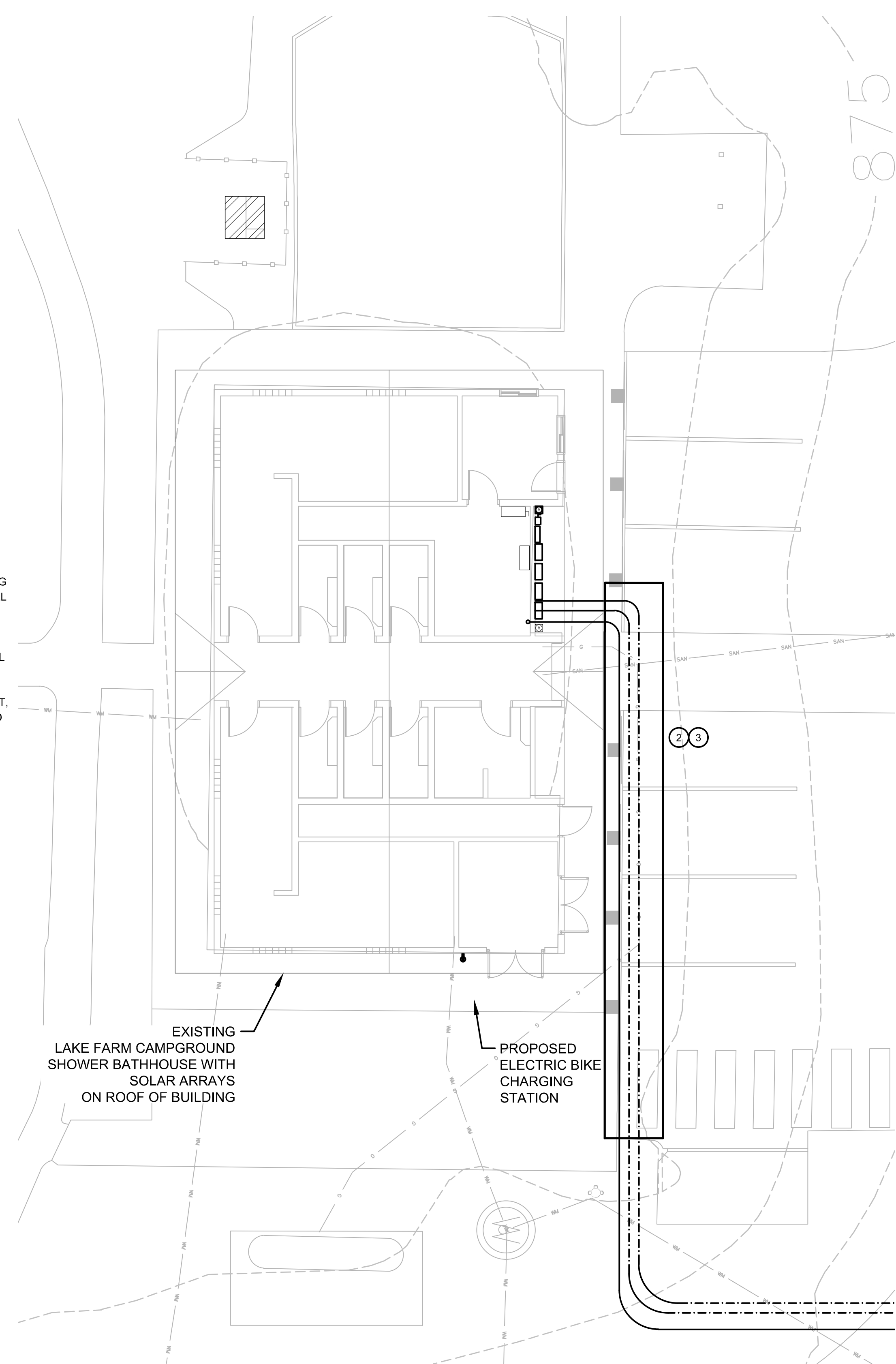

2 LAKE FARM CAMPGROUND SHOWER BUILDING - CIVIL SITE PLAN
 SCALE: 1/8" = 1'-0"
 NORTH

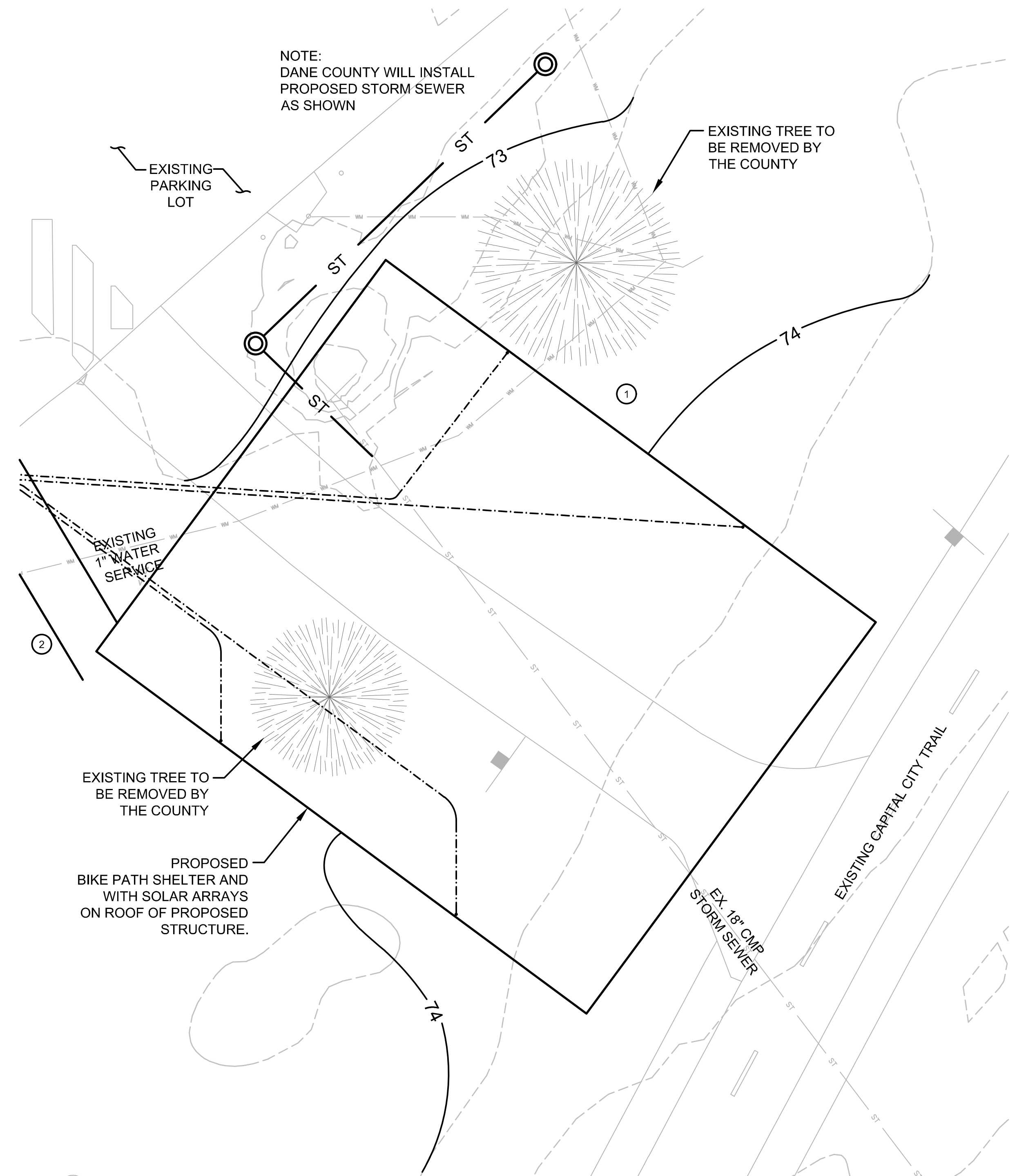

1 BIKE PATH SHELTER ARRAY - CIVIL SITE PLAN
 SCALE: 1/8" = 1'-0"
 NORTH

THE LOCATION OF EXISTING UTILITY INSTALLATIONS AS SHOWN ON THE PLAN ARE APPROXIMATE. THERE MAY BE OTHER UTILITY INSTALLATIONS WITHIN THE PROJECT AREA THAT ARE NOT SHOWN.

DIGGERS HOTLINE
 DIAL 811
 OR FILE ONLINE AT DIGGERSHOTLINE.COM

TO OBTAIN LOCATION OF PARTICIPANTS' UNDERGROUND FACILITIES BEFORE YOU DIG IN WISCONSIN:
 WIS. STATUTE 182.0175
 REQUIRES MIN. OF 3 WORK DAYS NOTICE BEFORE YOU EXCAVATE.

UTILITY COLOR CODE

 ELECTRIC	 GAS, OIL, PETROLEUM OR GASEOUS MATERIALS
 COMMUNICATION, CABLE TV, ALARM OR SIGNAL	 WATER, IRRIGATION AND SLURRY LINES
 SEWER AND DRAIN LINES	 TEMPORARY SURVEY MARKINGS
 PROPOSED EXCAVATION	

JDR
 ENGINEERING, INC.
 5525 NOBEL DRIVE
 SUITE 110
 MADISON, WI 53711
 PH: 608.277.1728 FAX: 608.271.7046

CONSULTANTS

DC ENGINEERING
 Careful listening. Dynamic solutions.
 www.dceengineering.net
 608.416.1041 Project: 19JDR01

ISSUED

12/20/2019	SD DOCUMENTS
2/16/2020	CD DOCUMENTS

REVISIONS / ADDENDA

-	_____
-	_____
-	_____
-	_____
-	_____

PROJECT # : 320010

DRAWN : JRH

CHECKED : SW

DATE : 16 March, 2020

PHASE : CD

PROJECT
 PV INSTALLATION AND DESIGN
 LUSSIER FAMILY HERITAGE
 CENTER AND LAKE
 FARM CAMPGROUND
 3101 LAKE FARM ROAD
 MADISON, WISCONSIN

LAKE FARM
 CAMPGROUND -
 CIVIL SITE PLAN

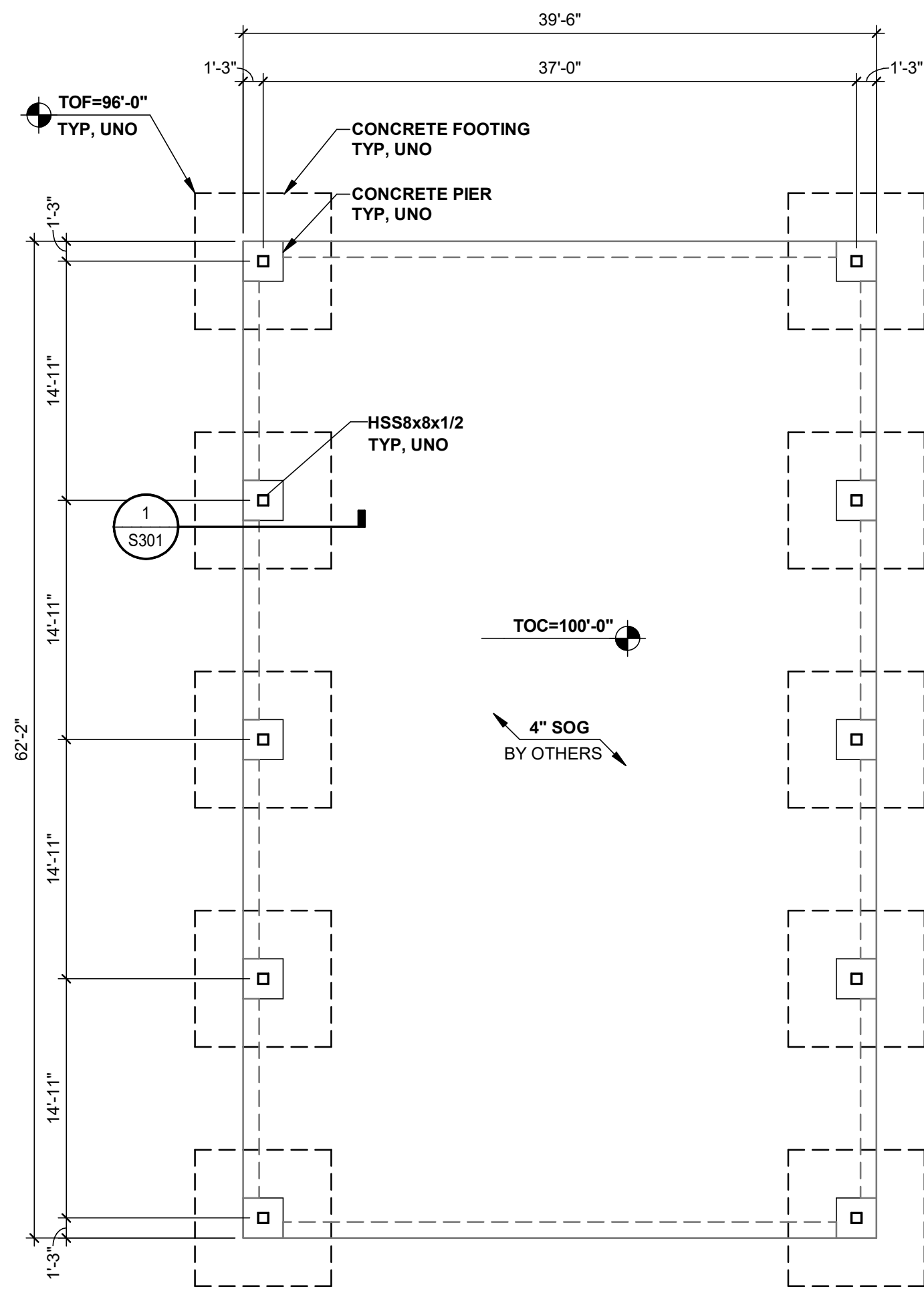

1 FOUNDATION PLAN - PARK SHELTER
SCALE: 1/8" = 1'-0"

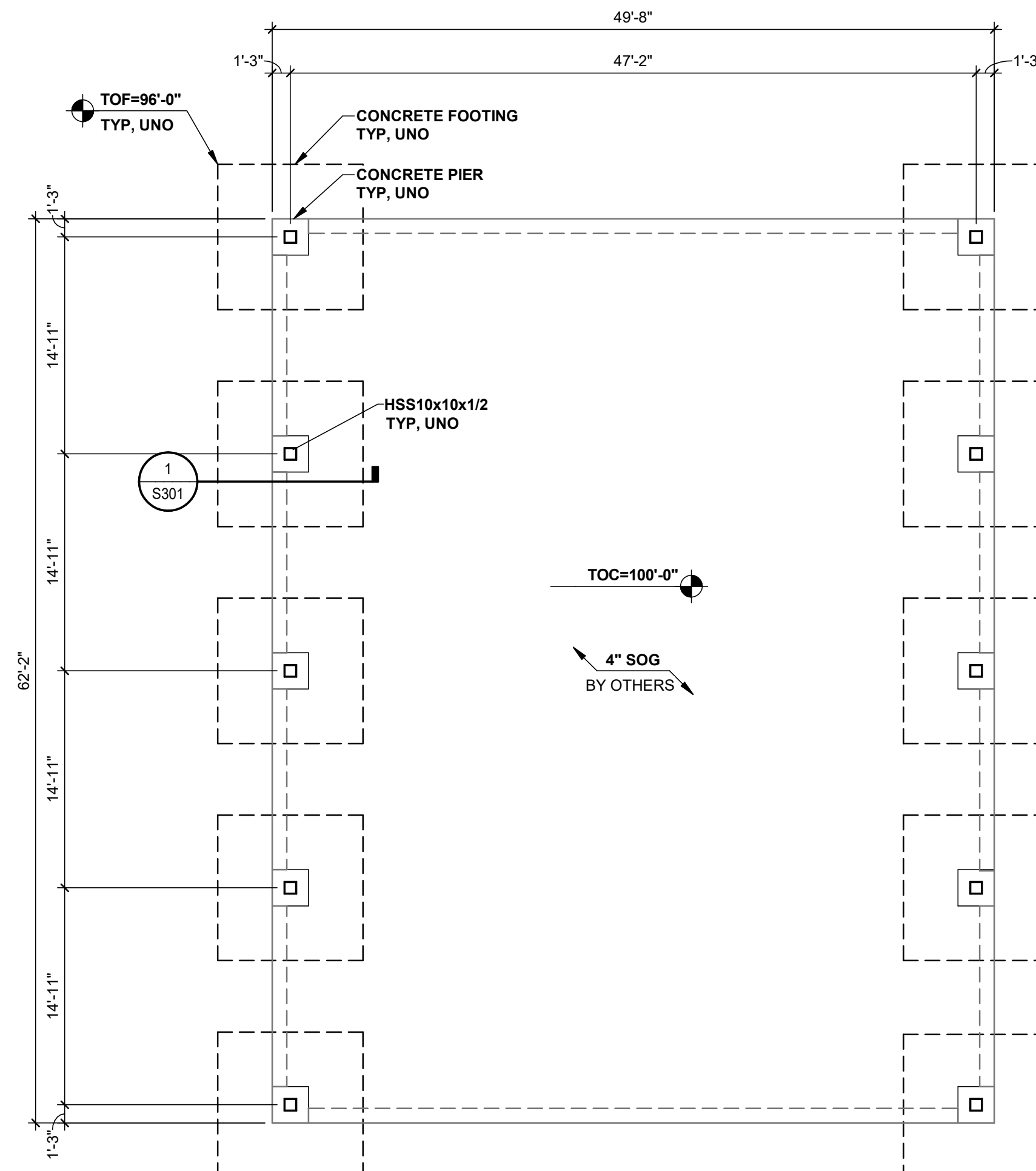

2 FOUNDATION PLAN - BIKE PATH SHELTER
SCALE: 1/8" = 1'-0"

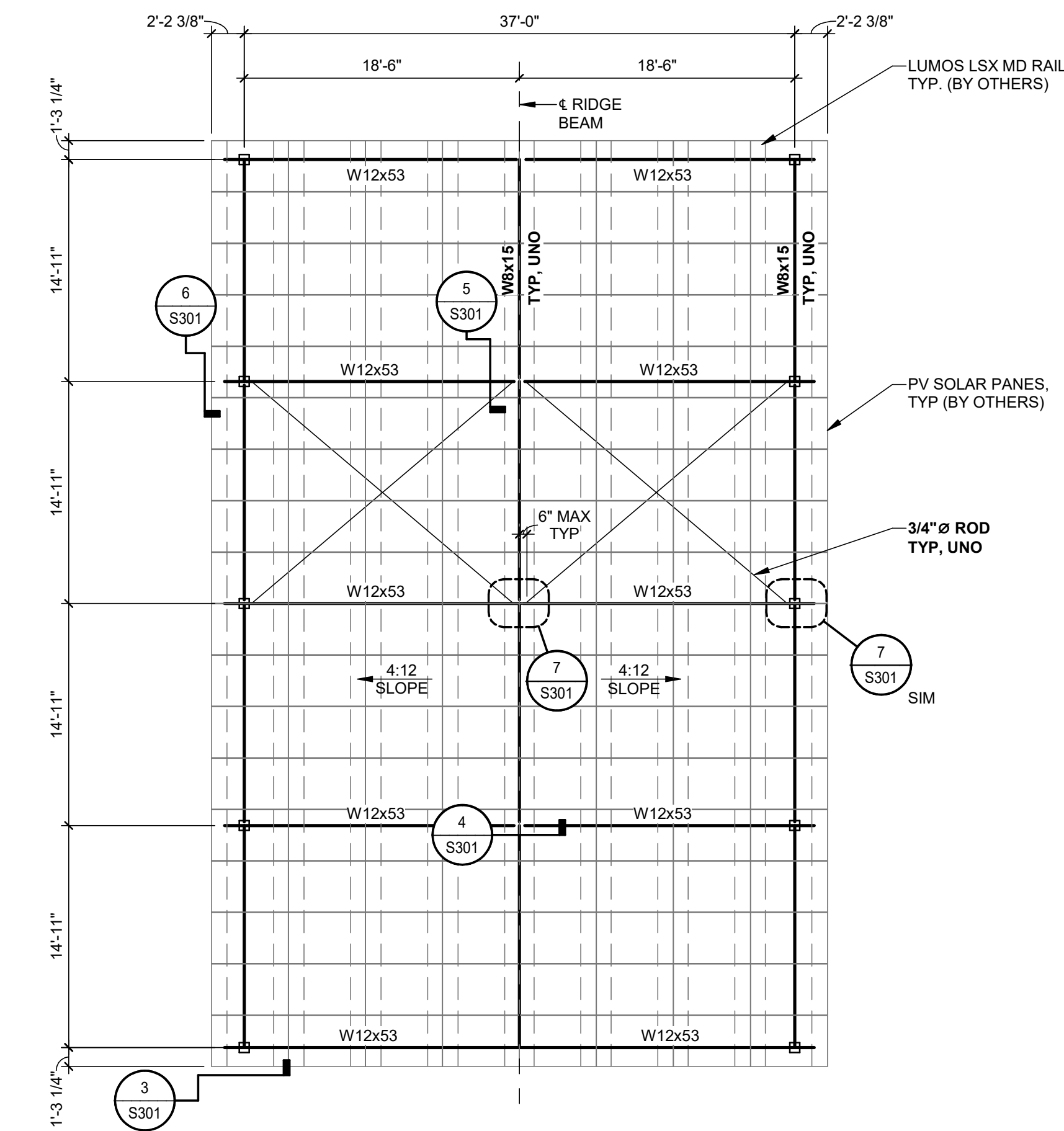
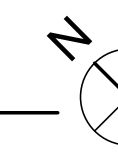

3 ROOF FRAMING PLAN - PARK SHELTER
SCALE: 1/8" = 1'-0"

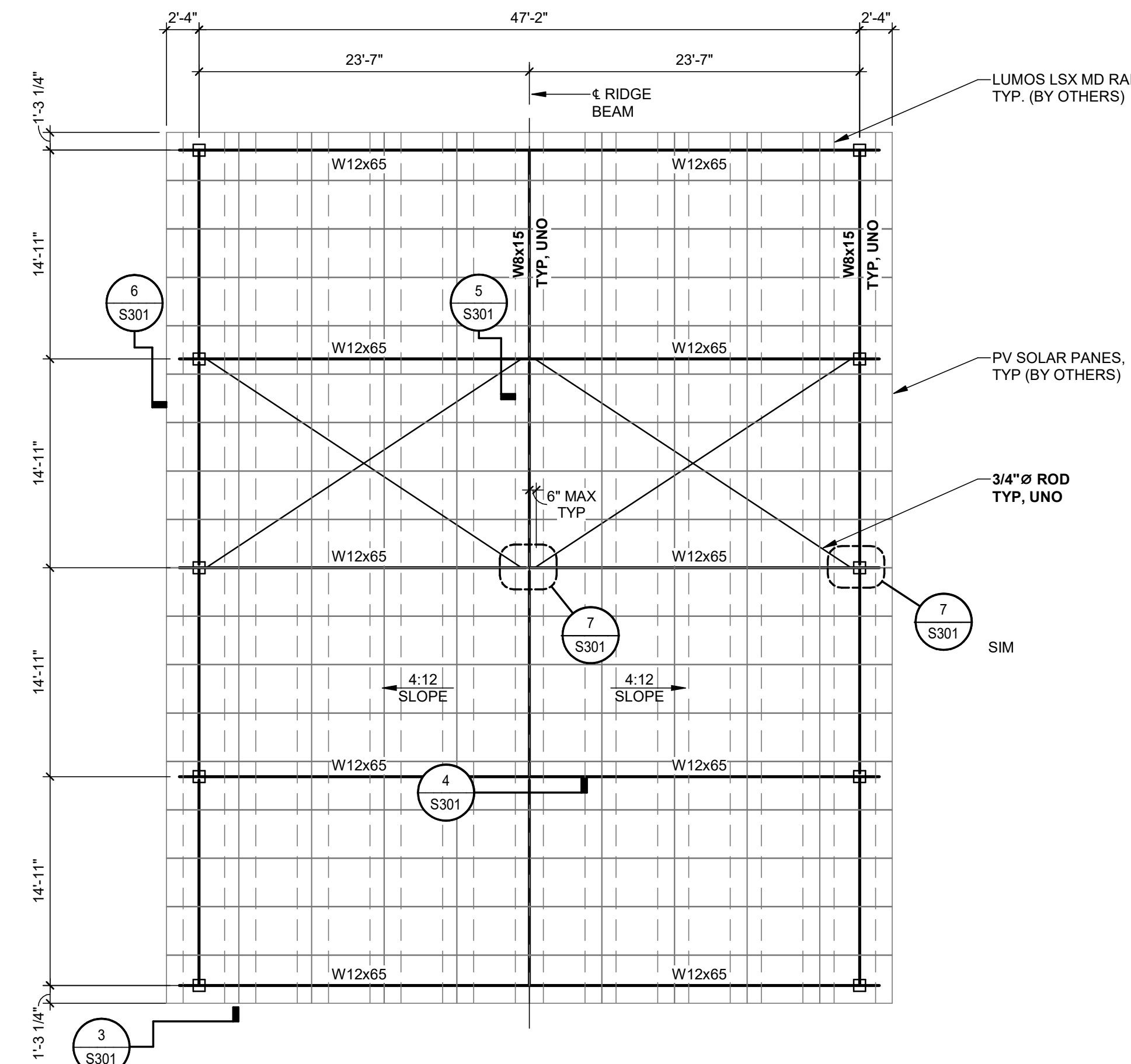

4 ROOF FRAMING PLAN - BIKE PATH SHELTER
SCALE: 1/8" = 1'-0"

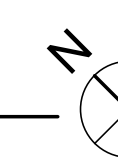

LEGEND

GENERAL

TOC=0'-0"

DENOTES ELEMENT ELEVATION:
(TOC) = TOP OF CONCRETE
(TOCP) = TOP OF CONCRETE PIER
(TOF) = TOP OF FOOTING
(TOS) = TOP OF STEEL

CONCRETE

4" SOG

DESCRIBES DIMENSIONS
(THICKNESS) (INCHES)

DENOTES SLAB ON GRADE

STEEL

W12x19 AISC BEAM DESIGNATION

HSS4x4x1/4 AISC COLUMN DESIGNATION

KEYNOTE SYMBOL LEGEND:

WA WHERE APPLICABLE

* DENOTES ELEMENT SIZE AND INFORMATION IS PROVIDED ON PLAN AND/OR APPLICABLE SCHEDULES.

KEYNOTES

ISSUED

12/20/2019	SD DOCUMENTS
03/16/2020	CD DOCUMENTS

REVISIONS / ADDENDA

-	
-	
-	
-	
-	

PROJECT #	320010
DRAWN:	PW
CHECKED:	JC
DATE:	16 March, 2020
PHASE:	CD

PROJECT:
PV INSTALLATION AND DESIGN
LUSSIER FAMILY HERITAGE
CENTER AND LAKE
FARM CAMPGROUND
3101 LAKE FARM ROAD
MADISON, WISCONSIN

FOUNDATION AND
FRAMING PLAN

PART 3 - EXECUTION

3.1 GENERAL NOTES

- A. THE METHODS, PROCEDURES, AND SEQUENCE OF CONSTRUCTION ARE THE RESPONSIBILITY OF THE CONTRACTOR.
- B. THE CONTRACTOR SHALL TAKE ALL NECESSARY PRECAUTIONS TO MAINTAIN AND ENSURE THE INTEGRITY OF THE STRUCTURE AT ALL STAGES OF CONSTRUCTION.
- C. THE CONTRACTOR SHALL TAKE THE RESPONSIBILITY TO PROVIDE SUPERVISION OF THE CONSTRUCTION TO INSURE COMPLIANCE WITH THE APPROVED PLANS AND SPECIFICATIONS.
- D. PER THE ADOPTED BUILDING CODE SECTION 1704.4. EACH CONTRACTOR RESPONSIBLE FOR THE CONSTRUCTION OF A MAIN WIND-FORCE-RESISTING OR SEISMIC-FORCE-RESISTING SYSTEM, DESIGNATED SEISMIC SYSTEM OR A WIND OR SEISMIC-RESISTING COMPONENT LISTED IN THE STATEMENT OF SPECIAL INSPECTIONS SHALL SUBMIT A WRITTEN STATEMENT OF RESPONSIBILITY TO THE BUILDING OFFICIAL AND THE OWNER PRIOR TO THE COMMENCEMENT OF WORK ON THE SYSTEM OR COMPONENT. THE CONTRACTOR'S STATEMENT OF RESPONSIBILITY SHALL CONTAIN ACKNOWLEDGEMENT OF AWARENESS OF THE SPECIAL REQUIREMENTS CONTAINED IN THE STATEMENT OF SPECIAL INSPECTION.

3.2 DEMOLITION

- A. THE CONTRACTOR MAY REMOVE EXISTING CONSTRUCTION AND REPLACE WITH THE APPROVAL OF THE LOCAL BUILDING DEPARTMENT AND STRUCTURAL ENGINEER.
- B. THE EXTENT OF THE DEMOLITION MAY OR MAY NOT BE SHOWN IN THESE CONSTRUCTION DOCUMENTS. THE CONSULTANTS SHALL NOT BE BACK CHARGED OR RESPONSIBLE FOR SHOWING OR NOT SHOWING THE ENTIRE EXTENT OF DEMOLITION.
- C. THE CONTRACTOR SHALL TAKE THE RESPONSIBILITY TO INSURE THE REMOVAL OF THE EXISTING STRUCTURE AND PROVIDE THE STRUCTURAL ENGINEER WITH METHODS, PROCEDURES AND SEQUENCE PLAN.

3.3 SPECIAL INSPECTIONS AND STRUCTURAL OBSERVATIONS

- A. CONTRACTOR IS RESPONSIBLE FOR NOTIFYING THE APPROPRIATE BUILDING OFFICIAL, REGISTERED SPECIAL INSPECTOR, AND/OR REGISTERED LICENSED ENGINEER FOR ALL SPECIAL INSPECTIONS OR TESTING REQUIRED IN THIS SECTION.
- B. CONTRACTOR SHALL SUBMIT ALL SPECIAL INSPECTION REPORTS TO STRUCTURAL ENGINEER OF RECORD WITHIN 14 DAYS OF EACH REPORT BEING COMPLETED.
- C. AN APPROVED AGENCY AS SET FORTH IN ADOPTED BUILDING CODE SECTION 1703 WITH THE APPROVAL OF THE BUILDING OFFICIAL MAY PERFORM SPECIAL INSPECTIONS.
- D. PER THE ADOPTED BUILDING CODE SECTION 1704.6, A STRUCTURAL OBSERVATION IS NOT REQUIRED.
- E. WHERE SPECIAL INSPECTION OR TESTING IS REQUIRED BY ADOPTED BUILDING CODE SECTION 1704 AND 1705 (SPECIAL INSPECTIONS), 1705.12 (SPECIAL INSPECTIONS FOR SEISMIC RESISTANCE), OR 1705.13 (STRUCTURAL TESTING FOR SEISMIC RESISTANCE), THE REGISTERED DESIGN PROFESSIONAL IN RESPONSIBLE CHARGE IS REQUIRED TO PREPARE A STATEMENT OF SPECIAL INSPECTION DESCRIBED IN THE FOLLOWING (ALL TABLES REFERENCED ARE FROM THE ADOPTED BUILDING CODE, UNO):
 - I. SOILS: REFER TO TABLE 1705.6
 - a. EXISTING SITE SOIL CONDITIONS
 - b. FILL PLACEMENT
 - c. LOAD-BEARING REQUIREMENTS
 - II. CONCRETE: NOT REQUIRED
 - III. STRUCTURAL STEEL
 - a. SPECIAL INSPECTION, QUALITY CONTROL, QUALITY ASSURANCE AND NON-DESTRUCTIVE TESTING FOR STRUCTURAL STEEL SHALL BE IN ACCORDANCE WITH REQUIREMENTS OF AISC 360-10, CHAPTER N.
 - i. FABRICATOR AND ERECTOR TO PERFORM QUALITY CONTROL PROCEDURES AND INSPECTIONS
 - ii. FABRICATOR AND ERECTOR TO HAVE REQUIRED DOCUMENTS AVAILABLE FOR REVIEW UPON REQUEST, UNLESS OTHERWISE REQUIRED IN THE CONTRACT DOCUMENTS TO BE SUBMITTED.
 - iii. INSPECTION OF WELDING
 - iv. NONDESTRUCTIVE TESTING OF WELDED JOINTS
 - v. INSPECTION OF HIGH-STRENGTH BOLTING
 - vi. OTHER INSPECTION TASKS:
 - A. INSPECTION OF FABRICATED STEEL
 - B. INSPECTION OF ERECTED STEEL
 - C. INSPECTION OF ANCHOR RODS
 - vii. EXCEPTION FOR APPROVED FABRICATORS AND ERECTORS:
 - A. QUALITY ASSURANCE MAY BE WAIVED WHEN THE WORK IS PERFORMED IN A FABRICATING SHOP OR BY AN ERECTOR APPROVED BY THE AUTHORITY HAVING JURISDICTION TO PERFORM THE WORK WITHOUT QUALITY ASSURANCE.

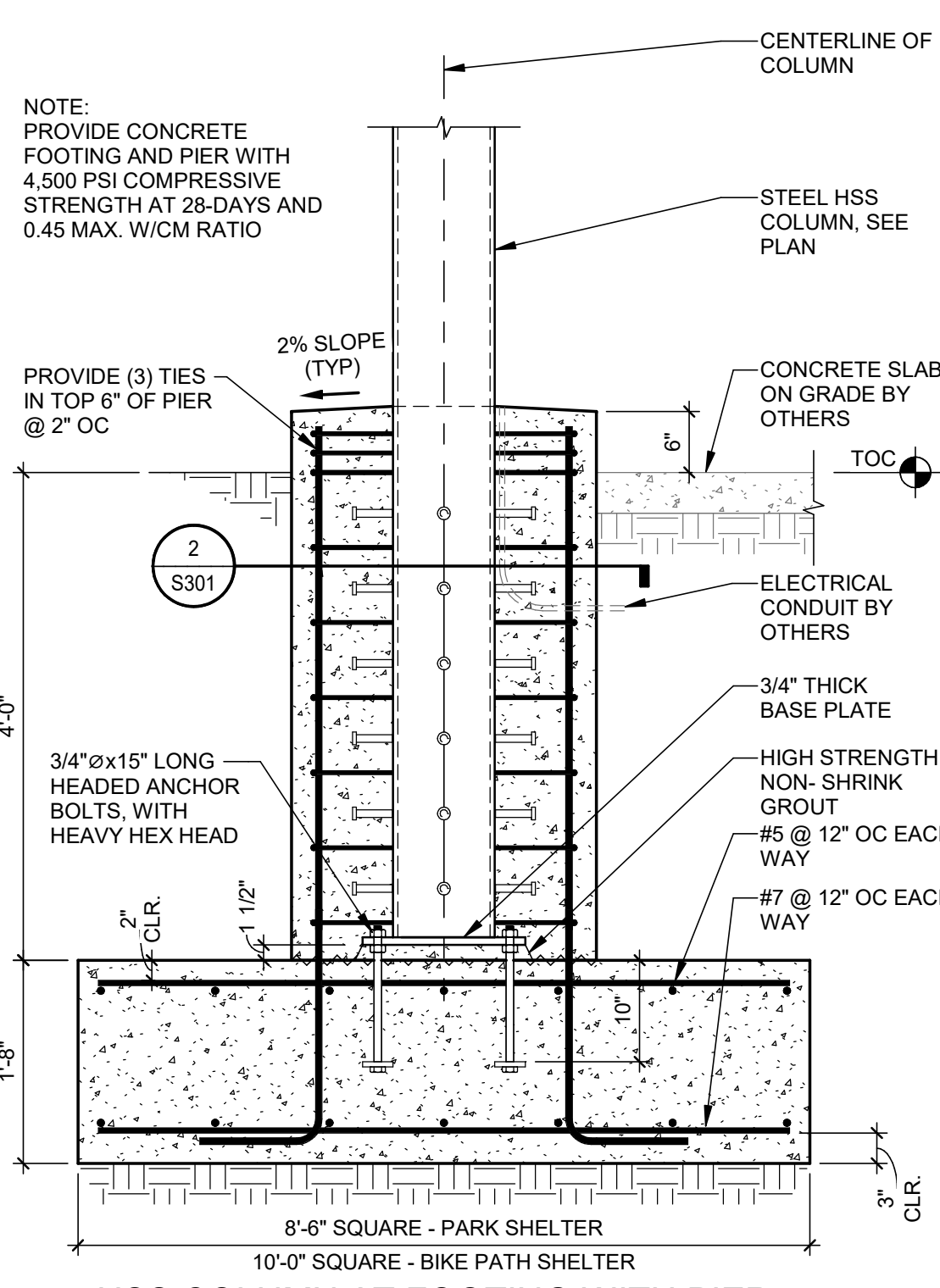
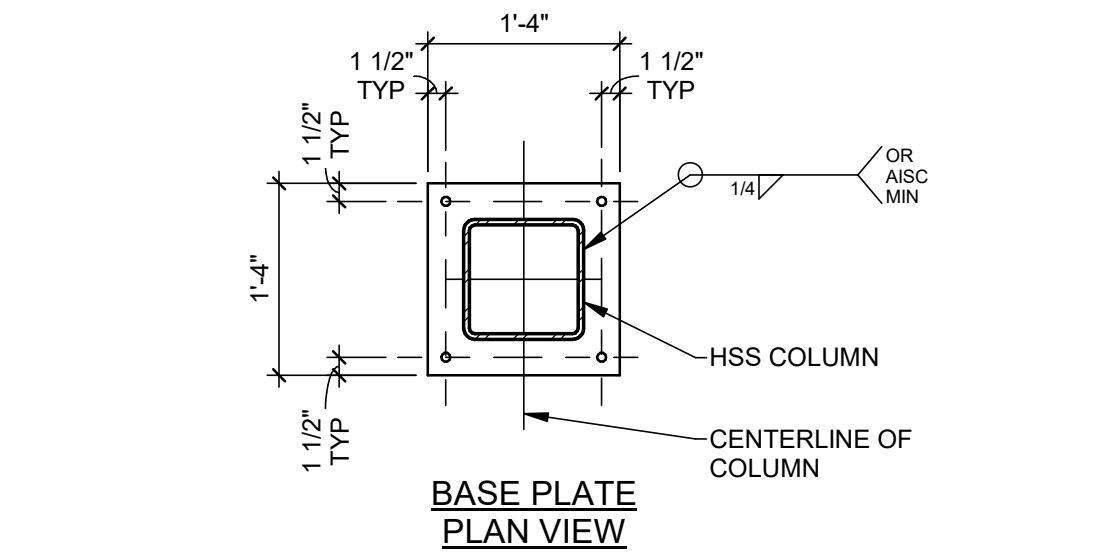

1 HSS COLUMN AT FOOTING WITH PIER
SCALE: NTS

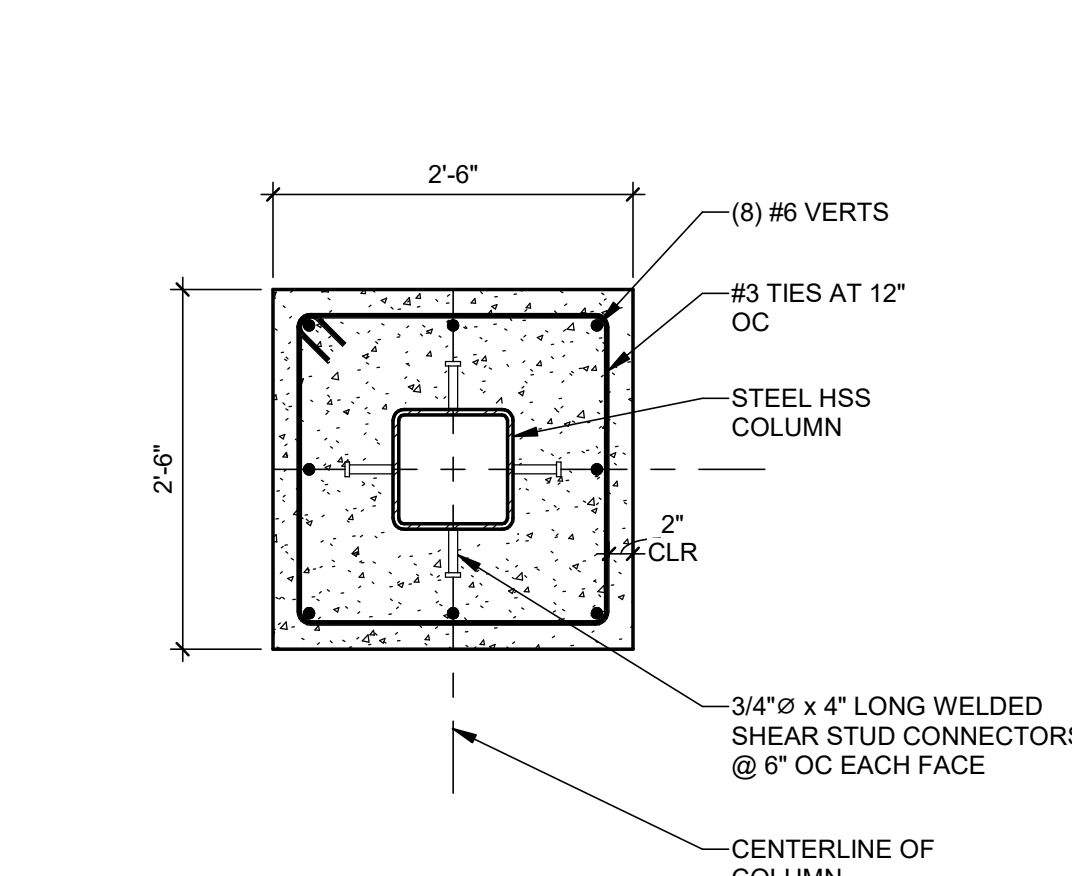

3 HSS COLUMN TO ROOF BEAM
SCALE: NTS

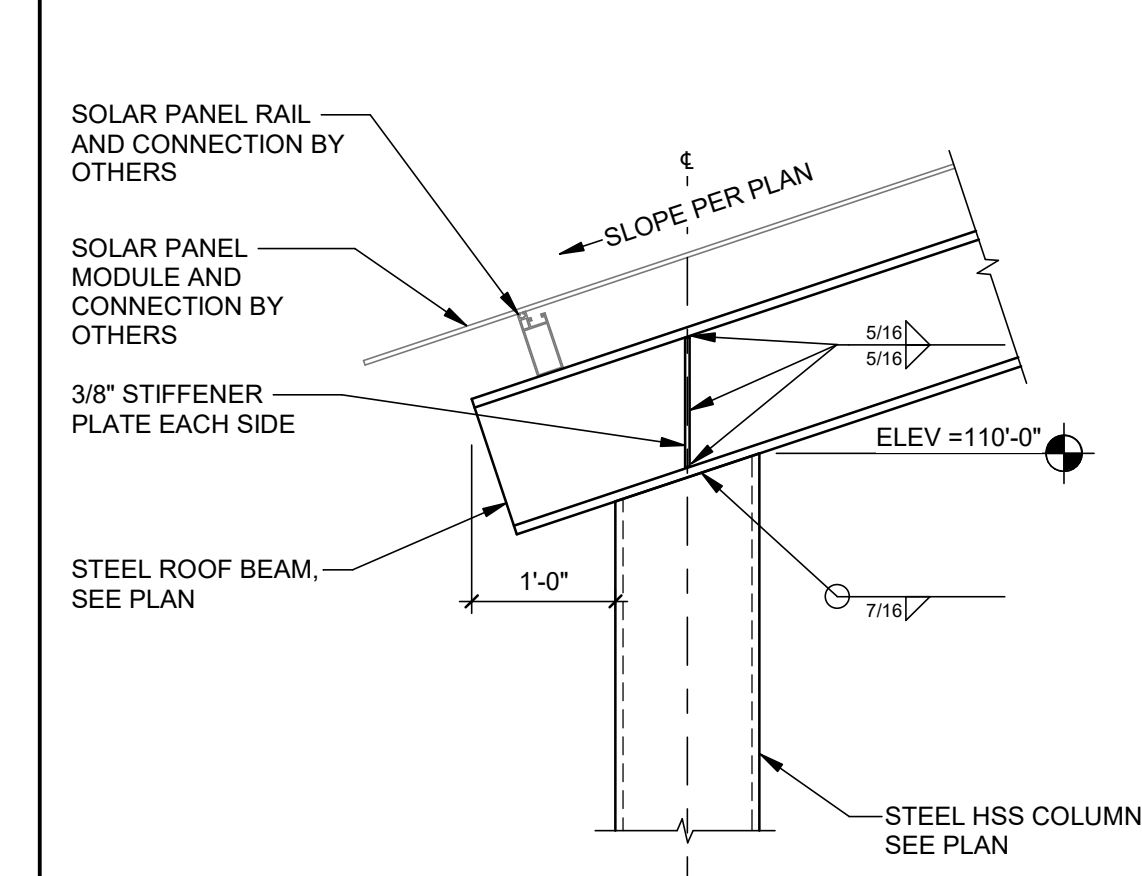

4 ROOF BEAM AT RIDGE CONNECTION
SCALE: NTS



5 ROOF BEAM CONNECTION
SCALE: NTS

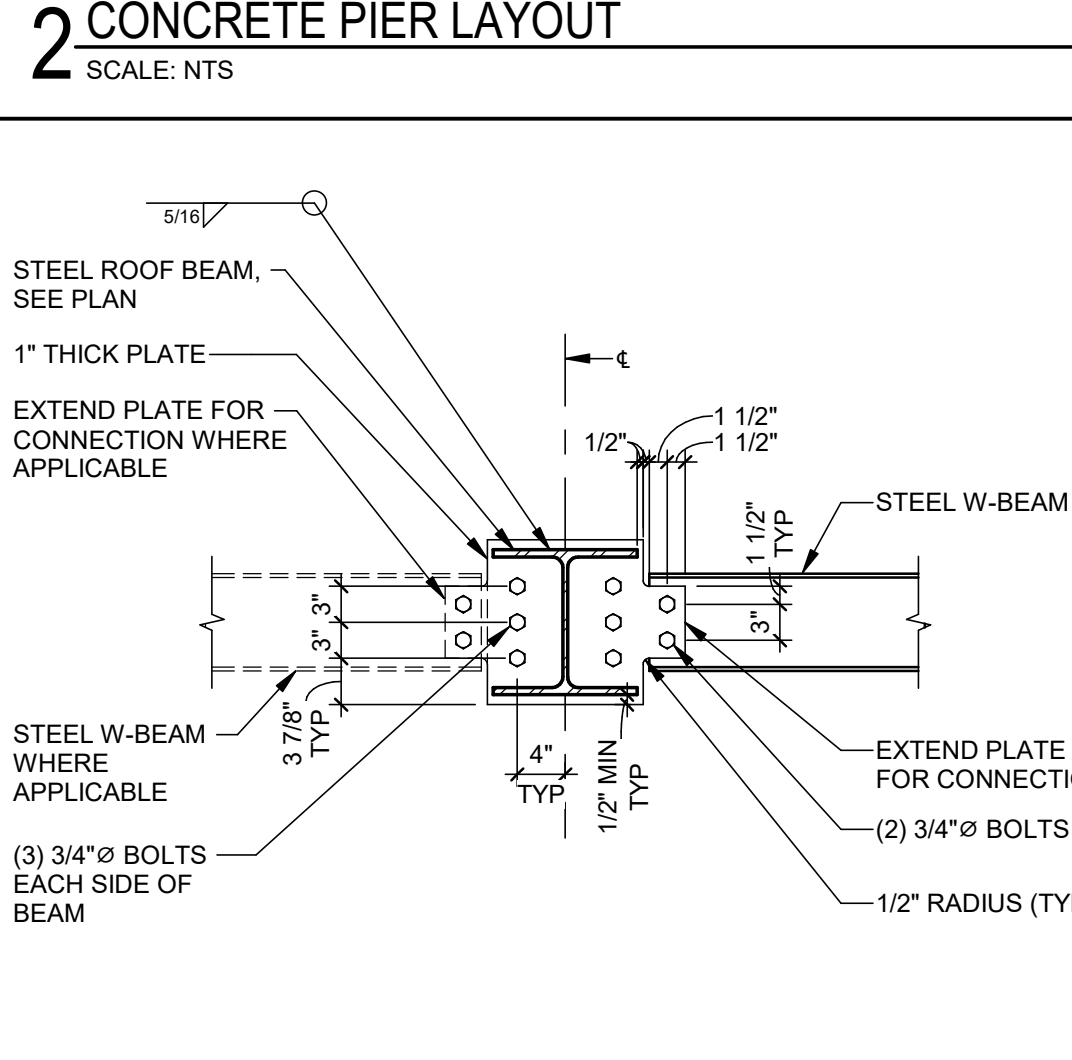

6 EAVE BEAM CONNECTION
SCALE: NTS

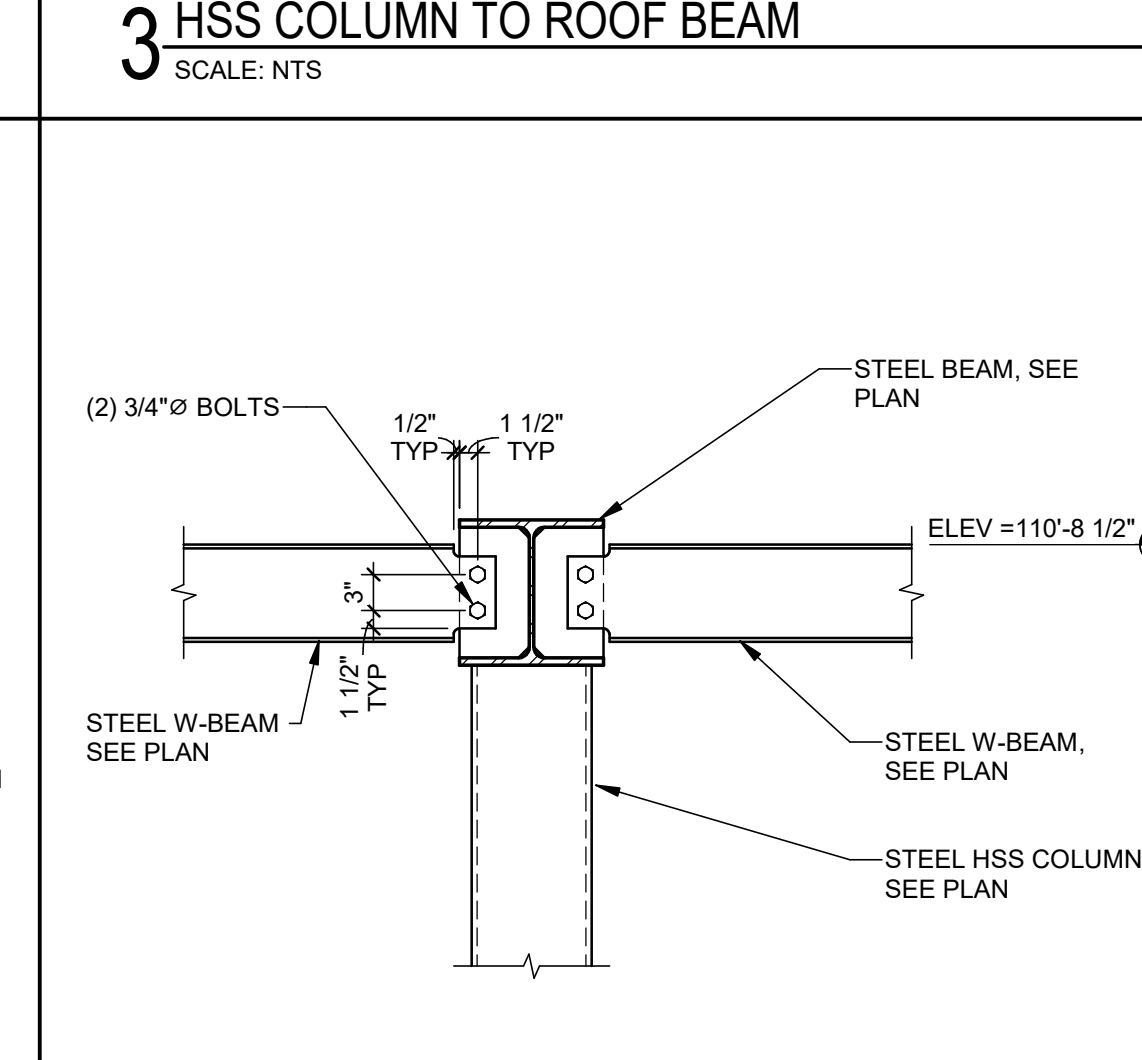

7 ROD BRACE CONNECTION TO BEAM
SCALE: NTS

TYPE	REQUIRED		CONT	PERIODIC
	YES	NO		
1. VERIFY MATERIALS BELOW SHALLOW FOUNDATIONS ARE ADEQUATE TO ACHIEVE THE DESIGN BEARING CAPACITY.	×			×
2. VERIFY EXCAVATIONS ARE EXTENDED TO PROPER DEPTH AND HAVE REACHED PROPER MATERIAL.	×			×
3. PERFORM CLASSIFICATION AND TESTING OF COMPACTED FILL MATERIALS.	×			×
4. VERIFY USE OF PROPER MATERIALS, DENSITIES AND LIFT THICKNESSES DURING PLACEMENT AND COMPACTION OF COMPACTED FILL.	×		×	
5. PRIOR TO PLACEMENT OF COMPACTED FILL, INSPECT SUBGRADE AND VERIFY THAT SITE HAS BEEN PREPARED PROPERLY.	×			×

JDR
ENGINEERING, INC.
5525 NOBEL DRIVE
SUITE 110
MADISON, WI 53711
PH: 608.277.1728 FAX: 608.271.7046

CONSULTANTS
DC ENGINEERING
Careful listening. Dynamic solutions.
www.dceengineering.net
Phone: 608.416.1041 Project: 19JDR01

ISSUED

12/20/2019	SD DOCUMENTS
03/16/2020	CD DOCUMENTS

REVISIONS / ADDENDA

-	
-	
-	
-	
-	

PROJECT # 320010
DRAWN: PW
CHECKED: JC
DATE: 16 March, 2020
PHASE: CD

PROJECT:
PV INSTALLATION AND DESIGN
LUSSIER FAMILY HERITAGE
CENTER AND LAKE
FARM CAMPGROUND
3101 LAKE FARM ROAD
MADISON, WISCONSIN

DETAILS
S301

CONSULTANTS

ISSUED

12/20/2019	SD DOCUMENTS
3/16/2020	CD DOCUMENTS

REVISIONS / ADDENDA

-	
-	
-	
-	
-	

PROJECT # :	320010
DRAWN :	---
CHECKED :	---
DATE :	16 March, 2020
PHASE :	CD

PROJECT
PV INSTALLATION AND DESIGN
LUSSIER FAMILY HERITAGE
CENTER AND LAKE
FARM CAMPGROUND
3101 LAKE FARM ROAD
MADISON, WISCONSIN

LUSSIER FAMILY
HERITAGE CENTER -
ELECTRICAL SITE PLAN

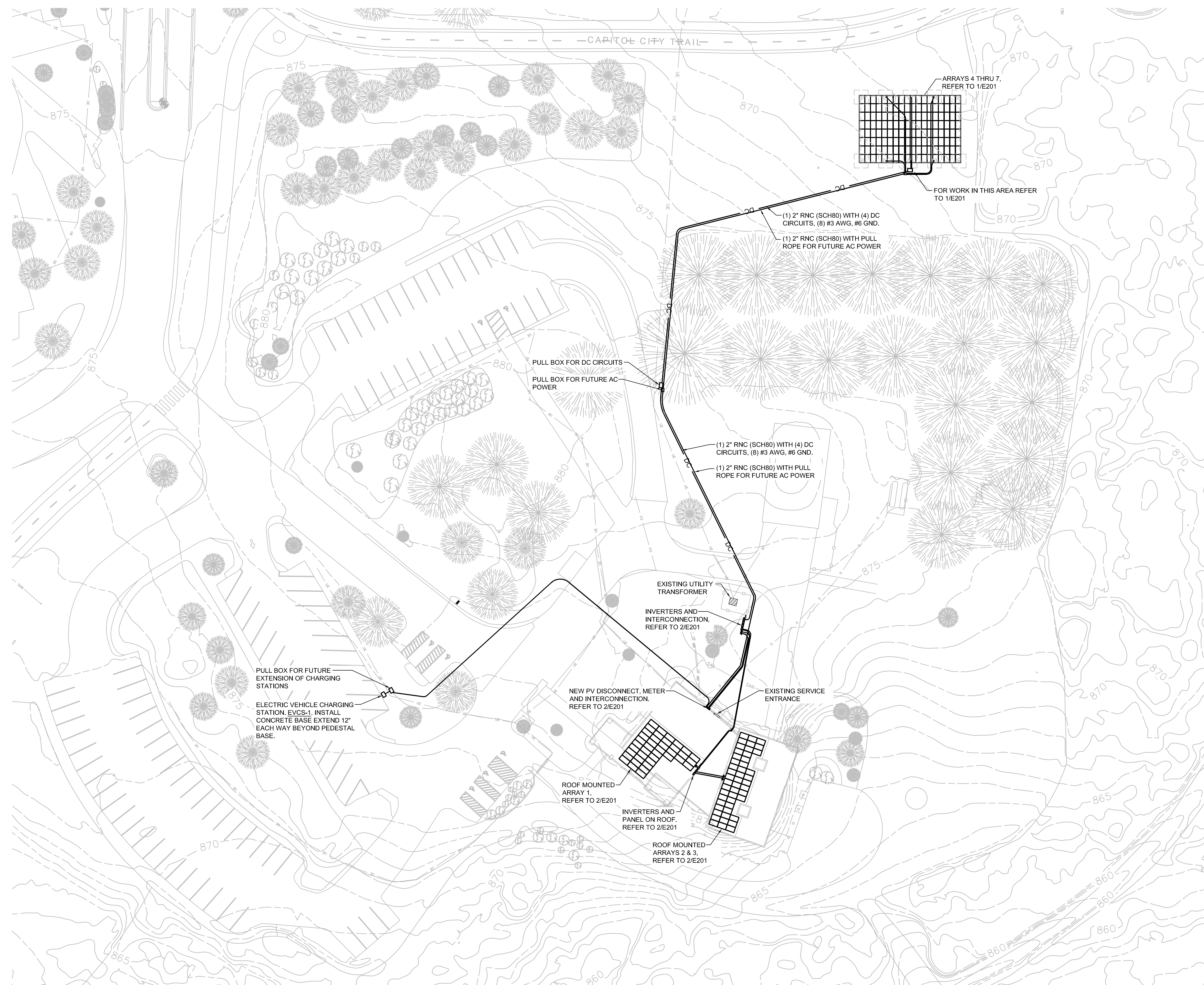

1 LUSSIER FAMILY HERITAGE CENTER - ELECTRICAL SITE PLAN
E101 SCALE: 1" = 30'



CONSULTANTS

ISSUED

12/20/2019 SD DOCUMENTS

3/16/2020 CD DOCUMENTS

REVISIONS / ADDENDA

-
-
-
-

PROJECT # : 320010

DRAWN : --

CHECKED : --

DATE : 16 March, 2020

PHASE : CD

PROJECT
 PV INSTALLATION AND DESIGN
 LUSSIER FAMILY HERITAGE
 CENTER AND LAKE
 FARM CAMPGROUND
 3101 LAKE FARM ROAD
 MADISON, WISCONSIN

LAKE FARM
 CAMPGROUND -
 ELECTRICAL SITE PLAN

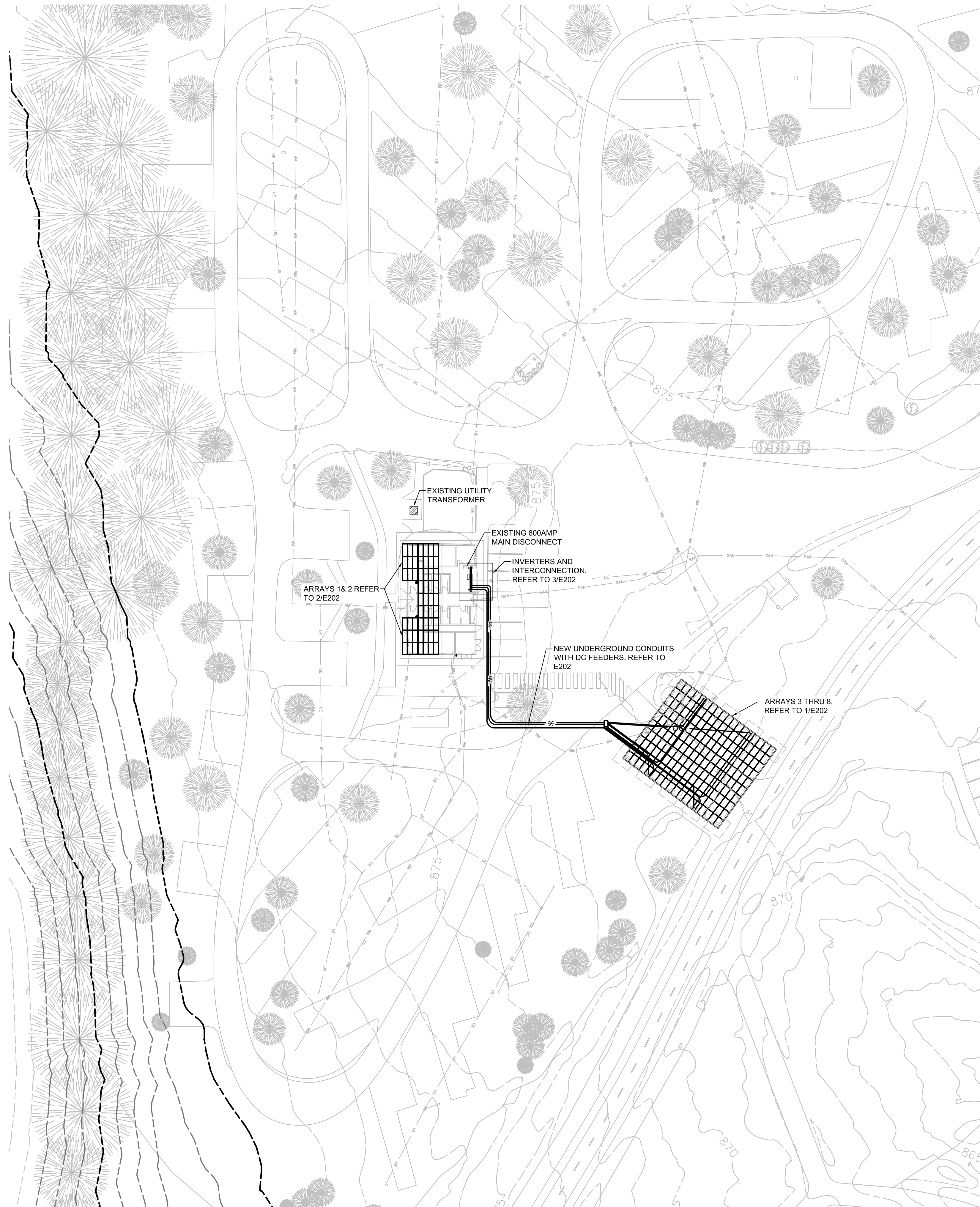

CONSULTANTS

ISSUED

12/20/2019 SD DOCUMENTS

3/16/2020 CD DOCUMENTS

REVISIONS / ADDENDA

PROJECT # : 320010

DRAWN : —

CHECKED : —

DATE : 16 March, 2020

PHASE : CD

PROJECT
PV INSTALLATION AND DESIGN
LUSSIER FAMILY HERITAGE
CENTER AND LAKE
FARM CAMPGROUND
3101 LAKE FARM ROAD
MADISON, WISCONSIN

HERITAGE CENTER
ELECTRICAL PLANS

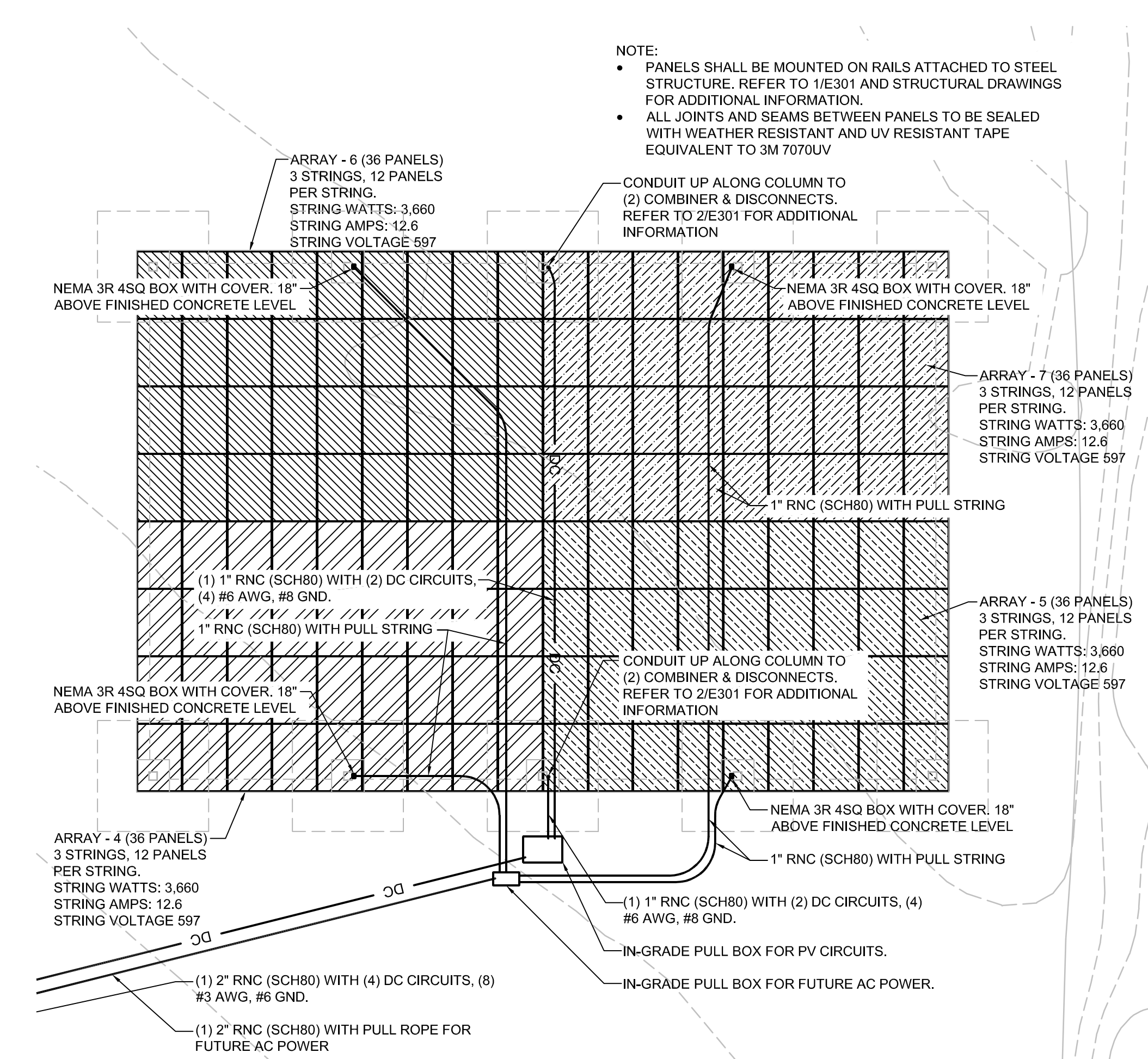
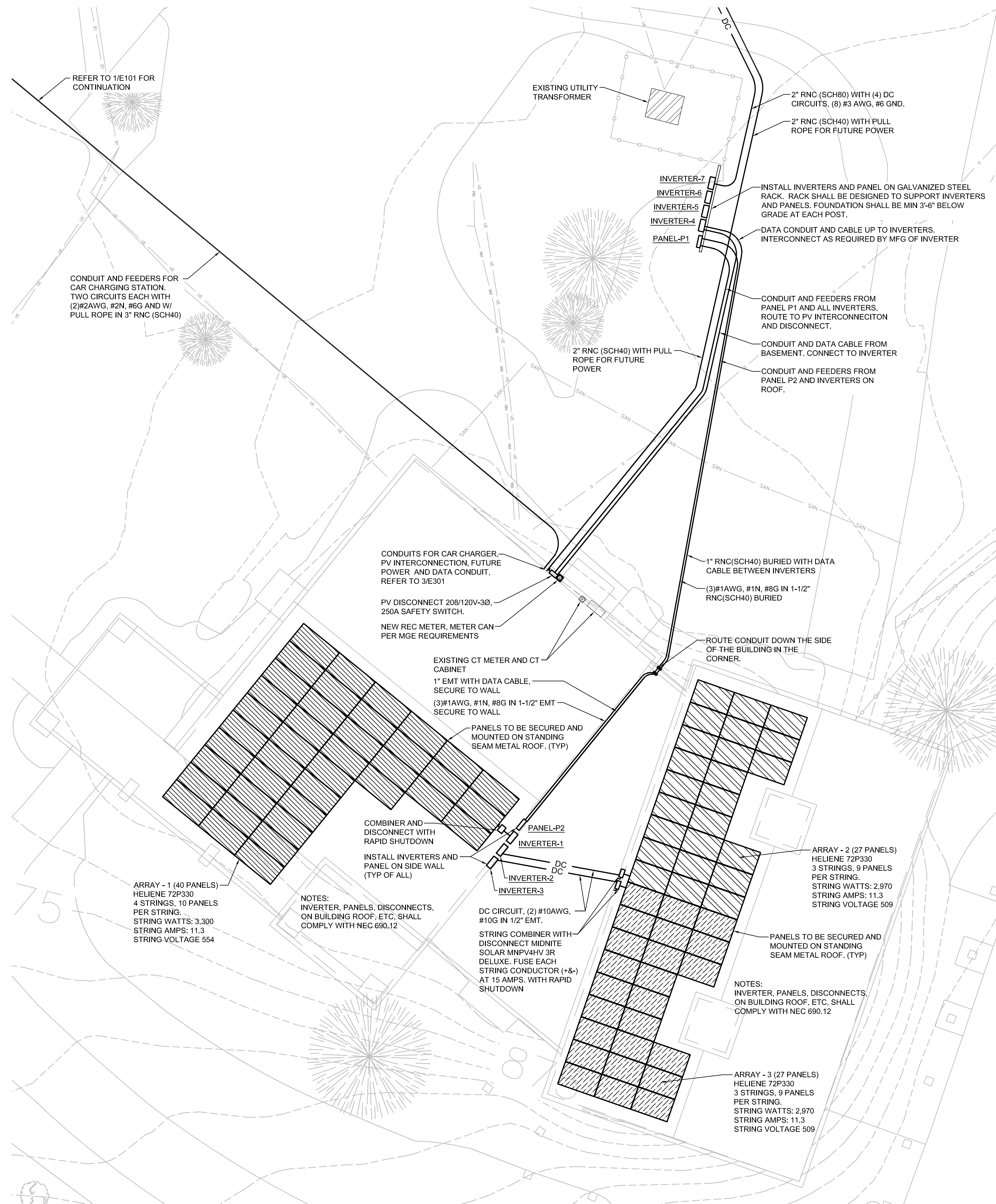

1 SHELTER ARRAY - ELECTRICAL PLAN
SCALE: 1/8" = 1'-0"

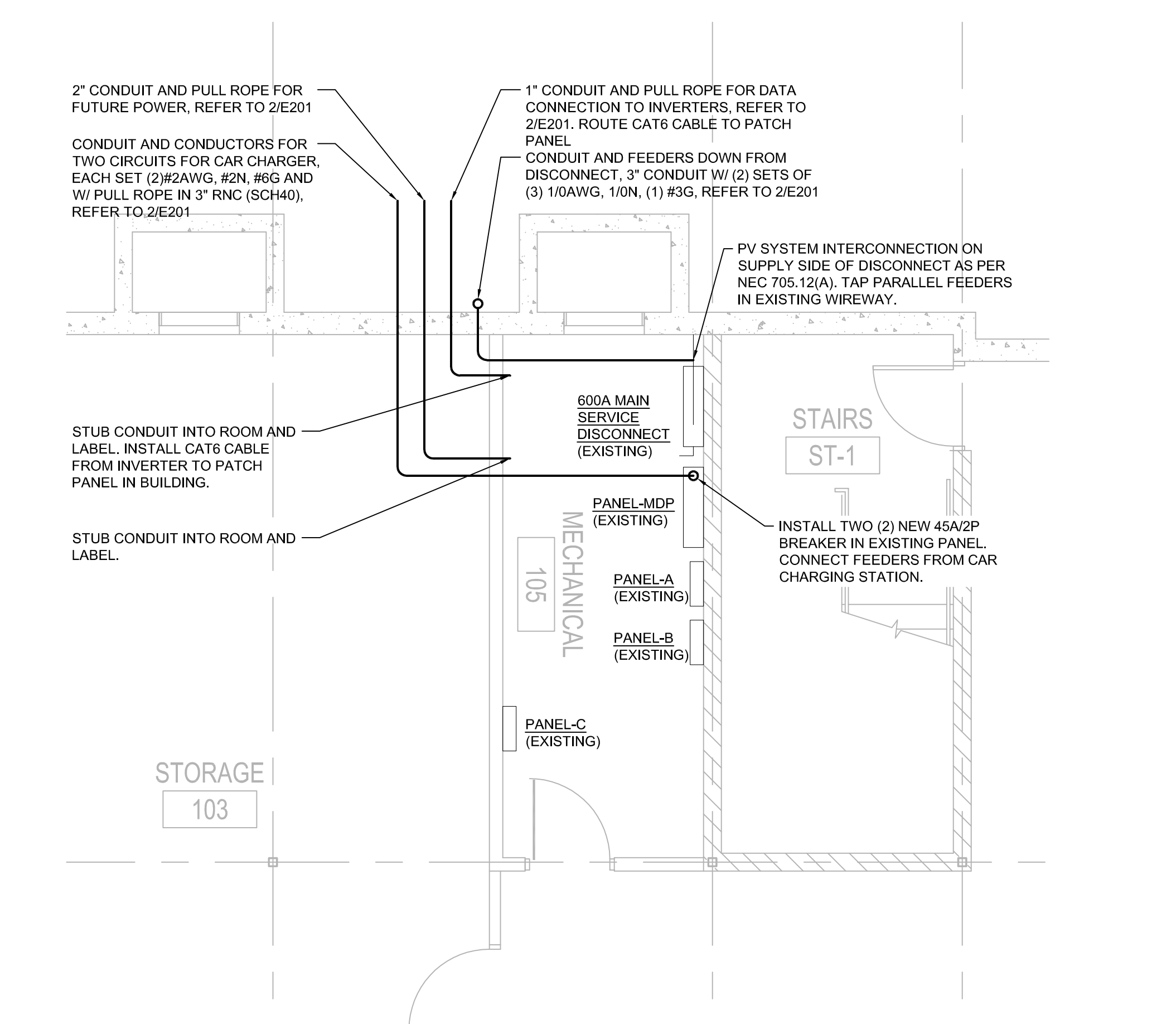

3 BASEMENT MECHANICAL AND ELECTRICAL ROOM
SCALE: 1/4" = 1'-0"

2 HERITAGE CENTER - ELECTRICAL PLAN
SCALE: 1/8" = 1'-0"

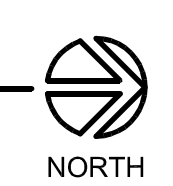

CONSULTANTS

ISSUED

12/20/2019 SD DOCUMENTS

3/16/2020 CD DOCUMENTS

REVISIONS / ADDENDA

-	
-	
-	
-	
-	
-	

PROJECT #: 320010

DRAWN: —

CHECKED: —

DATE: 16 March, 2020

PHASE: CD

PROJECT
PV INSTALLATION AND DESIGN
LUSSIER FAMILY HERITAGE
CENTER AND LAKE
FARM CAMPGROUND
3101 LAKE FARM ROAD
MADISON, WISCONSIN

LAKE FARM
CAMPGROUND
ELECTRICAL PLANS

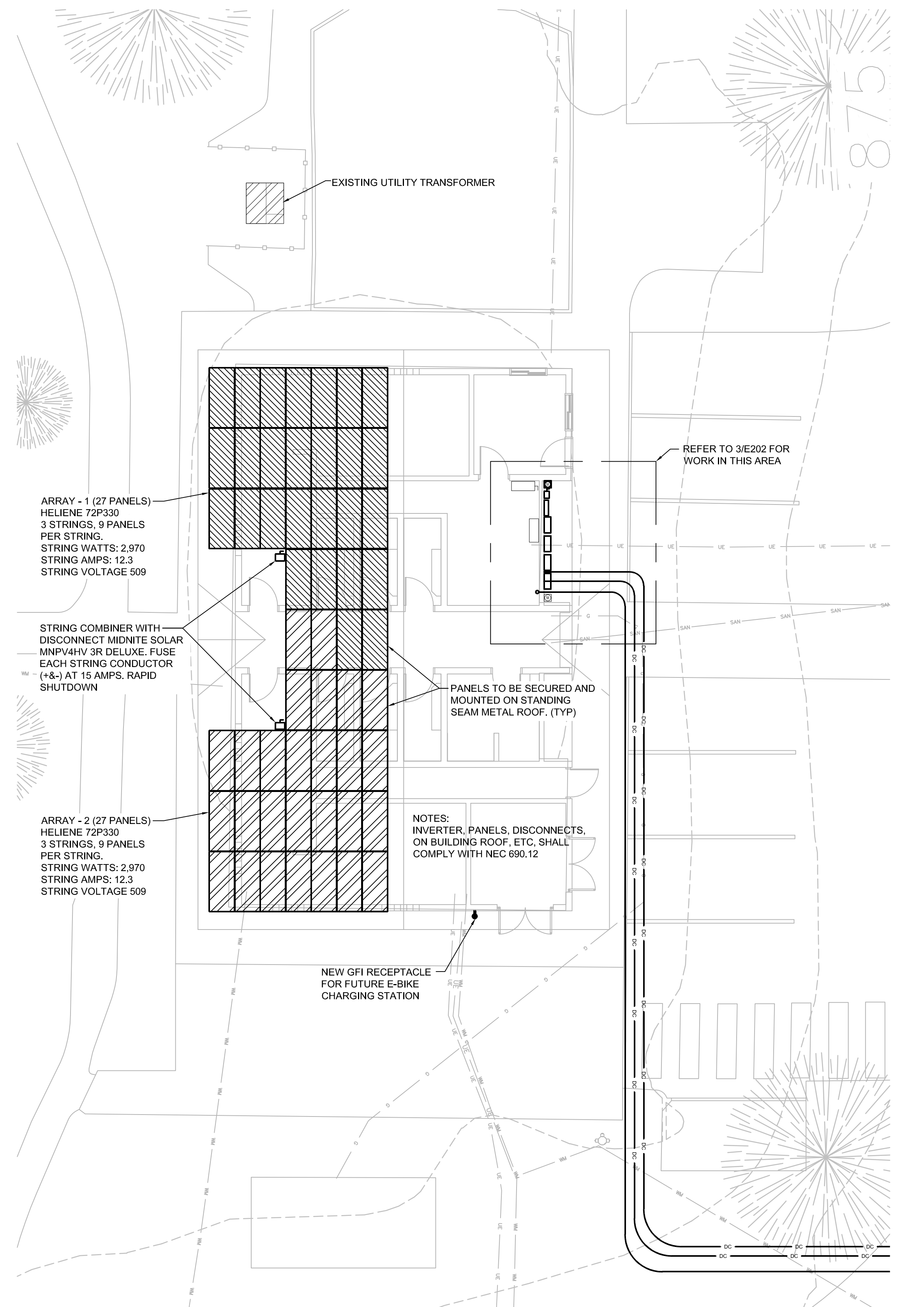

2 LAKE FARM CAMPGROUND SHOWER BUILDING - ELECTRICAL PLAN

SCALE: 1/8" = 1'-0"

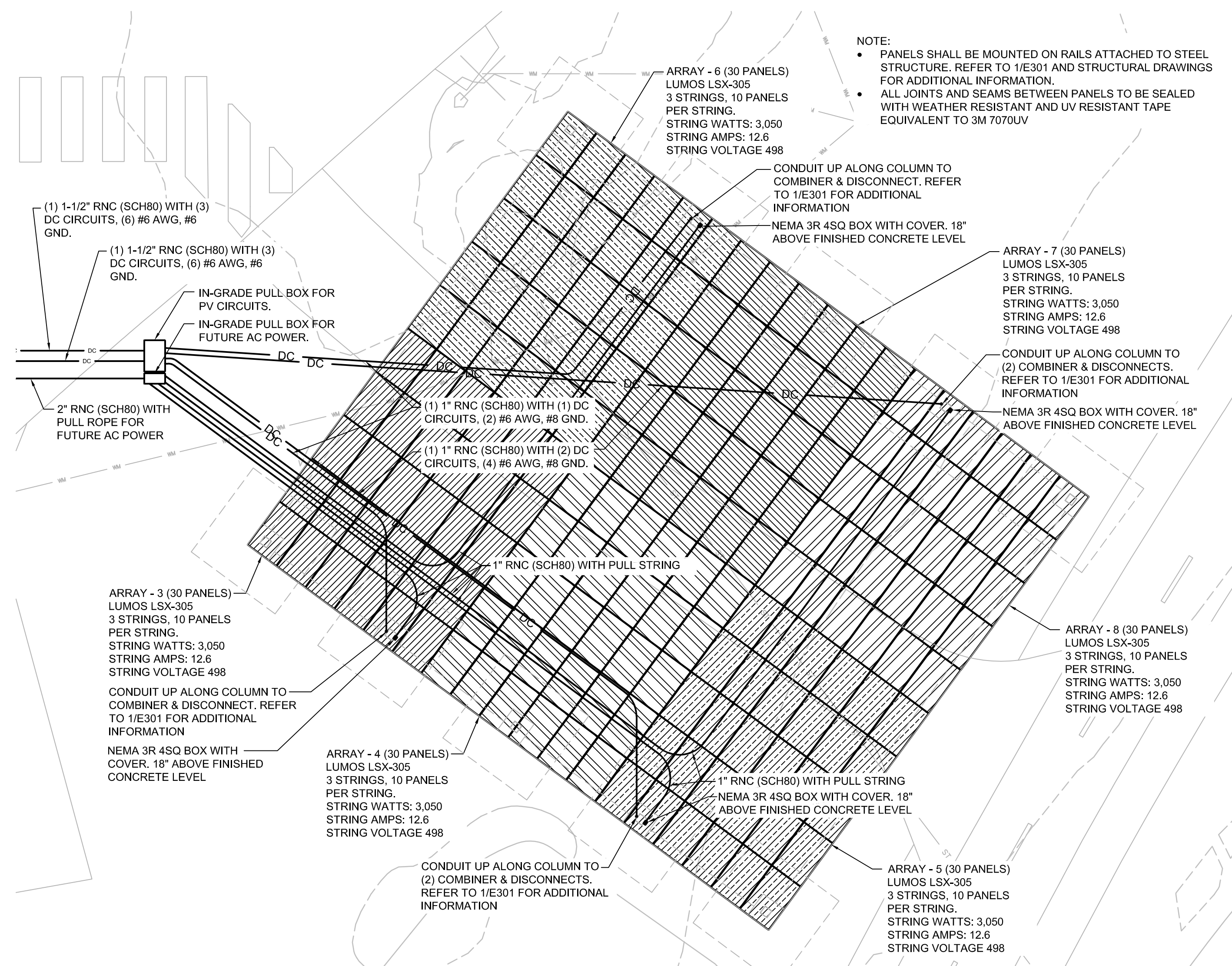

1 SHELTER ARRAY - ELECTRICAL PLAN

SCALE: 1/8" = 1'-0"

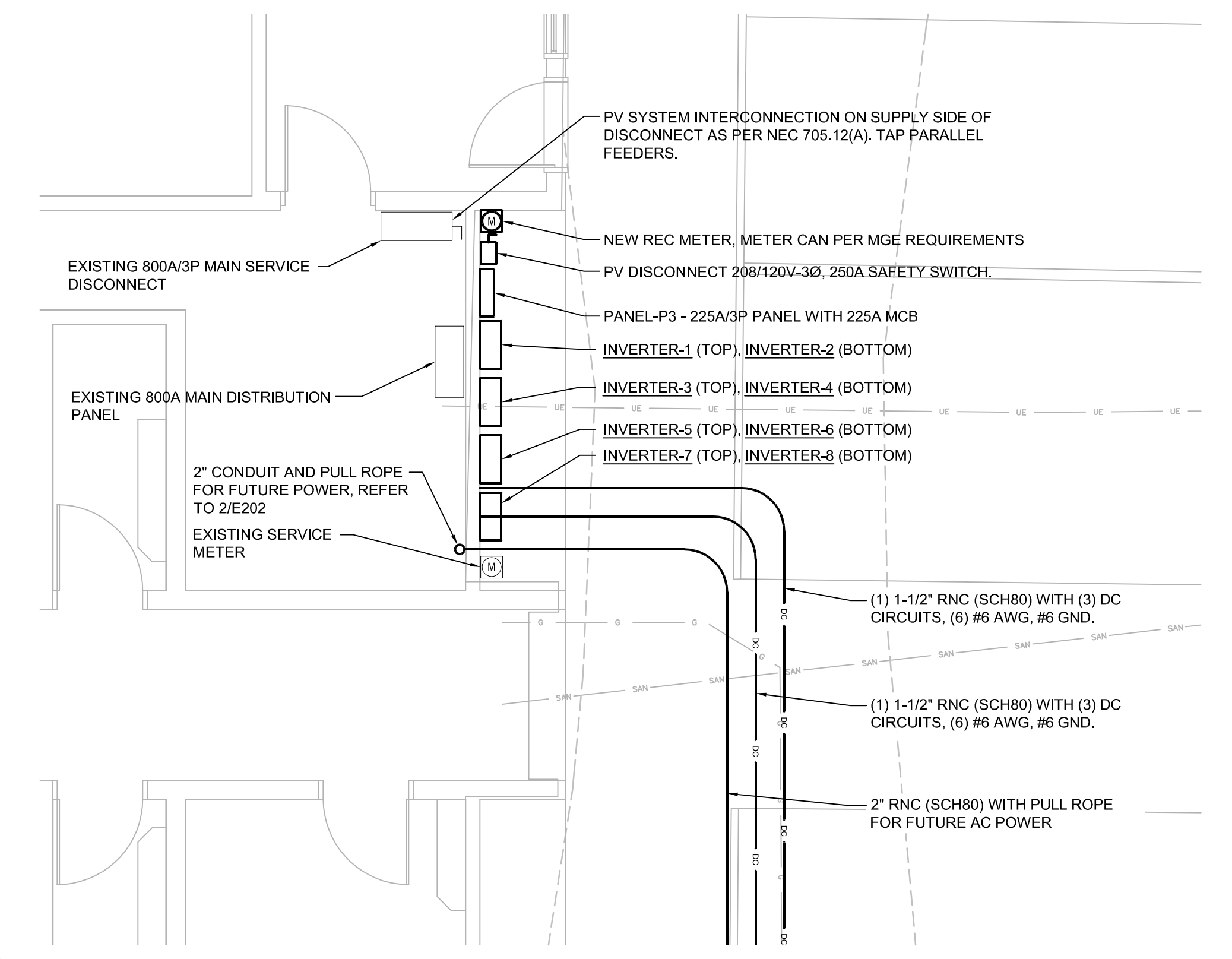

3 LAKE FARM CAMPGROUND SHOWER BUILDING - ELECTRICAL PLAN

SCALE: 1/4" = 1'-0"



E202

CONSULTANTS

ISSUED

12/20/2019 SD DOCUMENTS

3/16/2020 CD DOCUMENTS

REVISIONS / ADDENDA

-	
-	
-	
-	
-	

PROJECT # : 320010

DRAWN : --

CHECKED : --

DATE : 16 March, 2020

PHASE : CD

PROJECT
PV INSTALLATION AND DESIGN
LUSSIER FAMILY HERITAGE
CENTER AND LAKE
FARM CAMPGROUND
3101 LAKE FARM ROAD
MADISON, WISCONSIN

SHELTER ELEVATIONS

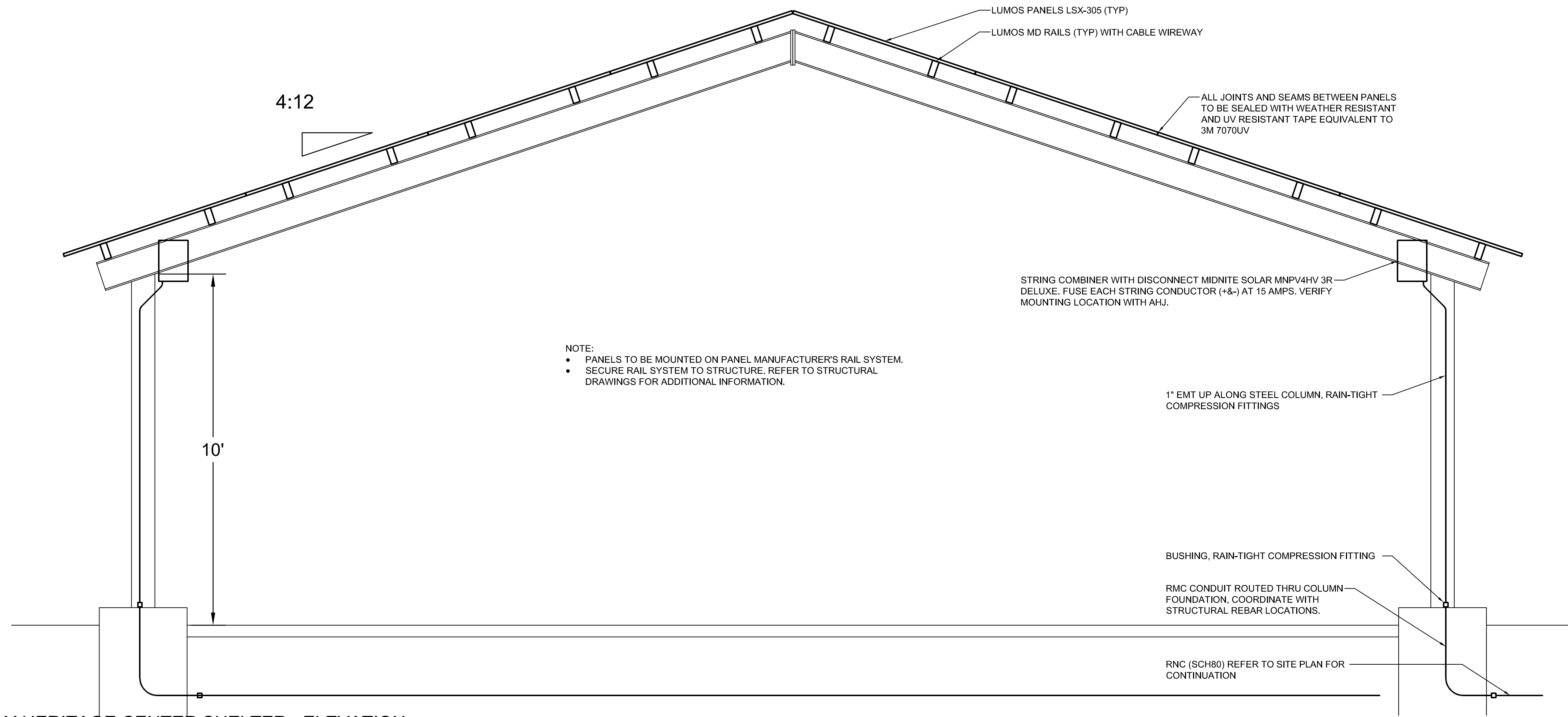

1 LUSSIER FAMILY HERITAGE CENTER SHELTER - ELEVATION
E301 SCALE: 1/2" = 1'-0"

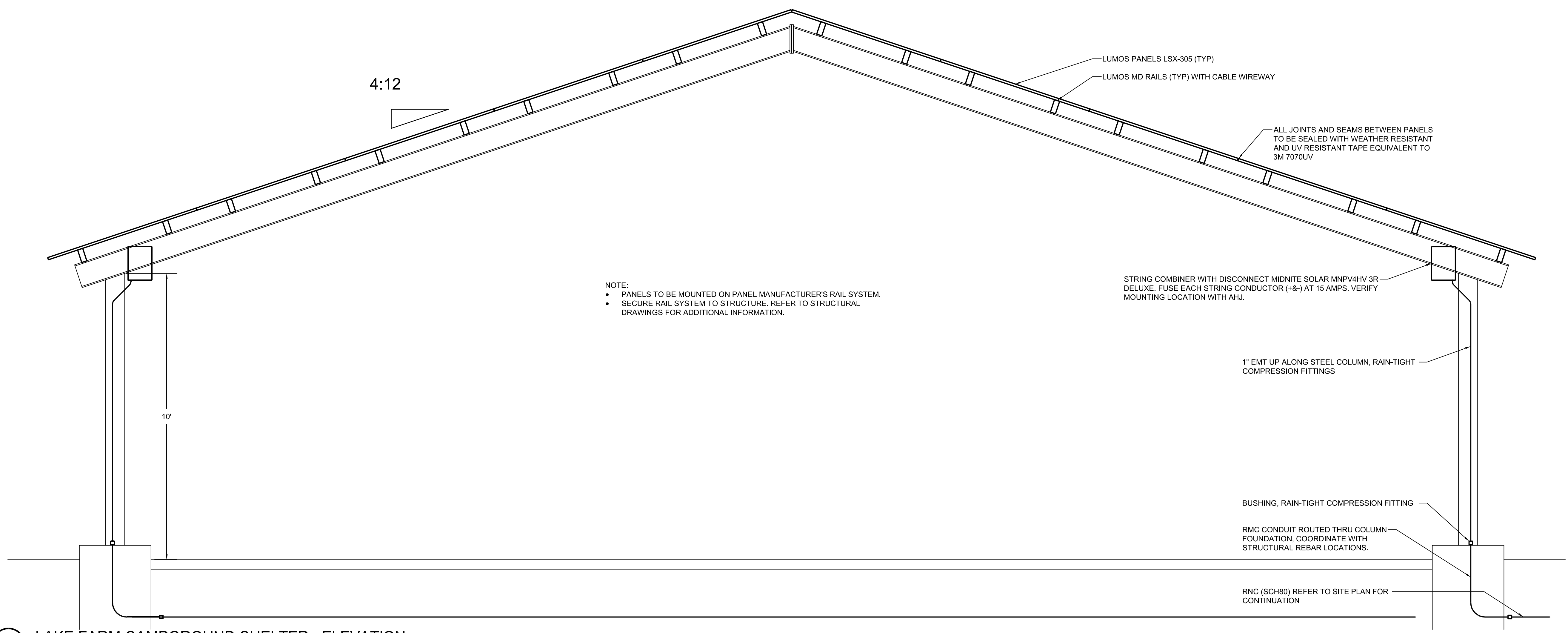

2 LAKE FARM CAMPGROUND SHELTER - ELEVATION
E301 SCALE: 1/2" = 1'-0"

CONSULTANTS

ISSUED

12/20/2019 SD DOCUMENTS

3/16/2020 CD DOCUMENTS

REVISIONS / ADDENDA

-
-
-
-
-

PROJECT #: 320010

DRAWN: --

CHECKED: --

DATE: 16 March, 2020

PHASE: CD

PROJECT
PV INSTALLATION AND DESIGN
LUSSIER FAMILY HERITAGE
CENTER AND LAKE
FARM CAMPGROUND
3101 LAKE FARM ROAD
MADISON, WISCONSIN

LUSSIER FAMILY
HERITAGE CENTER -
ELECTRICAL
ONE-LINE DIAGRAM

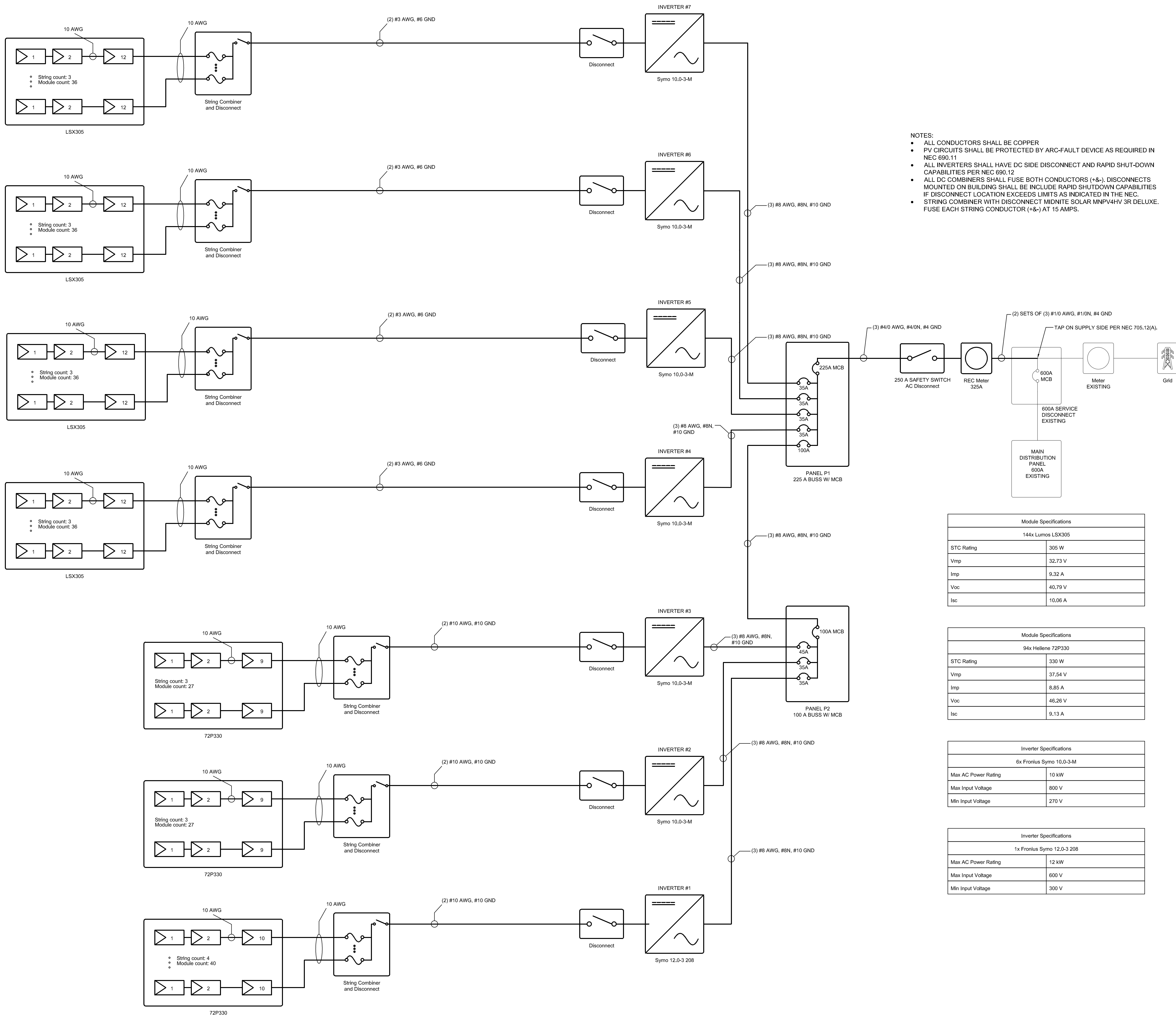

- NOTES:
- ALL CONDUCTORS SHALL BE COPPER
 - PV CIRCUITS SHALL BE PROTECTED BY ARC-FAULT DEVICE AS REQUIRED IN NEC 690.11
 - ALL INVERTERS SHALL HAVE DC SIDE DISCONNECT AND RAPID SHUT-DOWN CAPABILITIES PER NEC 690.12
 - ALL DC COMBINERS SHALL FUSE BOTH CONDUCTORS (+&-). DISCONNECTS MOUNTED ON BUILDING SHALL BE INCLUDE RAPID SHUTDOWN CAPABILITIES IF DISCONNECT LOCATION EXCEEDS LIMITS AS INDICATED IN THE NEC.
 - STRING COMBINER WITH DISCONNECT MIDNITE SOLAR MNPV4HV 3R DELUXE. FUSE EACH STRING CONDUCTOR (+&-) AT 15 AMPS.

Module Specifications	
144x Lumos LSX305	
STC Rating	305 W
Vmp	32.73 V
Imp	9.32 A
Voc	40.79 V
Isc	10.06 A

Module Specifications	
94x Heliene 72P330	
STC Rating	330 W
Vmp	37.54 V
Imp	8.85 A
Voc	46.26 V
Isc	9.13 A

Inverter Specifications	
6x Fronius Symo 10.0-3-M	
Max AC Power Rating	10 kW
Max Input Voltage	800 V
Min Input Voltage	270 V

Inverter Specifications	
1x Fronius Symo 12.0-3 208	
Max AC Power Rating	12 kW
Max Input Voltage	600 V
Min Input Voltage	300 V

CONSULTANTS

ISSUED

12/20/2019 SD DOCUMENTS

3/16/2020 CD DOCUMENTS

REVISIONS / ADDENDA

PROJECT #: 320010

DRAWN: --

CHECKED: --

DATE: 16 March, 2020

PHASE: CD

PROJECT
PV INSTALLATION AND DESIGN
LUSSIER FAMILY HERITAGE
CENTER AND LAKE
FARM CAMPGROUND
3101 LAKE FARM ROAD
MADISON, WISCONSIN

LAKE FARM
CAMPGROUND -
ELECTRICAL ONE-LINE
DIAGRAM

- NOTES:
- ALL CONDUCTORS SHALL BE COPPER
 - PV CIRCUITS SHALL BE PROTECTED BY ARC-FAULT DEVICE AS REQUIRED IN NEC 690.11
 - ALL INVERTERS SHALL HAVE DC SIDE DISCONNECT AND RAPID SHUT-DOWN CAPABILITIES PER NEC 690.12
 - ALL DC COMBINERS SHALL FUSE BOTH CONDUCTORS (+&-). DISCONNECTS MOUNTED ON BUILDING SHALL INCLUDE RAPID SHUTDOWN CAPABILITIES IF DISCONNECT LOCATION EXCEEDS LIMITS AS INDICATED IN THE NEC.
 - STRING COMBINER WITH DISCONNECT MIDNITE SOLAR MNPV4HV 3R DELUXE. FUSE EACH STRING CONDUCTOR (+&-) AT 15 AMPS.

Module Specifications	
180x Lumos LSX305	
STC Rating	305 W
Vmp	32.73 V
Imp	9.32 A
Voc	40.79 V
Isc	10.06 A

Module Specifications	
56x Hellene 72P330	
STC Rating	330 W
Vmp	37.54 V
Imp	8.85 A
Voc	46.26 V
Isc	9.13 A

Inverter Specifications	
8x Fronius Symo 10.0-3-M	
Max AC Power Rating	10 kW
Max Input Voltage	800 V
Min Input Voltage	270 V

