

RFB NO. 318066



# CONSTRUCTION DOCUMENTS PROJECT MANUAL

DANE COUNTY DEPARTMENT OF PUBLIC WORKS,  
HIGHWAY AND TRANSPORTATION

**PUBLIC WORKS ENGINEERING DIVISION**  
1919 ALLIANT ENERGY CENTER WAY  
MADISON, WISCONSIN 53713

**REQUEST FOR BIDS NO. 318066**  
**PUBLIC SAFETY BUILDING ROOF REPLACEMENT**  
**DANE COUNTY PUBLIC SAFETY BUILDING**  
**115 W DOTY ST.**  
**MADISON, WISCONSIN**

Due Date / Time: **TUESDAY, AUGUST 27, 2019 / 2:00 P.M.**

Location: **PUBLIC WORKS OFFICE**

Performance / Payment Bond: **100% OF CONTRACT AMOUNT**

Bid Deposit: **5% OF BID AMOUNT**

---

FOR INFORMATION ON THIS REQUEST FOR BIDS, PLEASE CONTACT:

J. ERIC URTESE, AIA - PROJECT MANAGER  
TELEPHONE NO.: 608/266-4798  
FAX NO.: 608/267-1533  
E-MAIL: [urtes.eric@countyofdane.com](mailto:urtes.eric@countyofdane.com)

## **TABLE OF CONTENTS FOR RFB NO. 318066**

### **DIVISION 00 - PROCUREMENT AND CONTRACTING REQUIREMENTS**

Project Manual Cover Page  
Table of Contents  
Advertisement for Bids (Legal Notice)  
Best Value Contracting Application  
Instructions to Bidders  
Bid Form  
Fair Labor Practices Certification  
Sample Public Works Construction Contract  
Sample Bid Bond  
Sample Performance Bond  
Sample Payment Bond  
General Conditions of Contract  
Supplementary Conditions

### **DIVISION 01 - GENERAL REQUIREMENTS**

01 00 00 - Basic Requirements  
01 74 19 - Construction Waste Management, Disposal & Recycling  
00600 – Sample Storage Agreement  
00700 – General and Supplementary Conditions  
01090 – References  
01091 – Definitions  
01300 – Submittals  
01400 – Quality Requirements  
01630 – Substitutions and Product Options

### **DIVISION 02 - EXISTING CONDITIONS**

02070 - Demolition

### **DIVISION 06 - WOOD, PLASTICS AND COMPOSITES**

06010 – General Carpentry

### **DIVISION 07 - THERMAL AND MOISTURE PROTECTION**

07201 – Insulation  
07531 – EPDM Sheet Roofing Adhered  
07620 – Sheet Metal Flashing and Trim  
07900 - Sealants

### **DRAWINGS**

Plot drawings on 24" x 36" (ARCH D) paper for correct scale or size.

Sheet 1 – Roof Plan  
Sheet 2 – Roof Details I  
Sheet 3 – Roof Details II

**LEGAL NOTICE**

**INVITATION TO BID**

Dane County Dept. of Public Works, Hwy & Transp., 1919 Alliant Energy Center Way, Madison, WI 53713, will receive sealed Bids until:

**2:00 P.M., TUESDAY, AUGUST 27, 2019**

**RFB NO. 318066**

**PUBLIC SAFETY BUILDING ROOF REPLACEMENT**

**DANE COUNTY PUBLIC SAFETY BUILDING**

**115 W DOTY ST., MADISON, WI**

Dane County is inviting Bids for construction services to replace the roof on the Public Safety Building. Only firms with capabilities, experience & expertise with similar projects should obtain this Request for Bids document & submit Bids.

Request for Bids document may be obtained after **2:00 p.m. on July 16, 2019** by downloading it from [bids-pwht.countyofdane.com](http://bids-pwht.countyofdane.com). Please call J. Eric Urtes, Project Mgr, at 608/266-4798, or our office at 608/266-4018, for any questions or additional information.

All Bidders must be pre-qualified as a Best Value Contractor before award of Contract. Complete Pre-qualification Application for Contractors at [countyofdane.com/pwht/BVC\\_Application.aspx](http://countyofdane.com/pwht/BVC_Application.aspx) or obtain one by calling 608/267-0119.

A pre-bid site tour will be held July 30, 2019 at 10:00 a.m. at the Public Safety Building, starting in the lobby. Bidders are required to attend this mandatory tour in order to bid on the Work.

**PUBLISH:     JULY 16 & JULY 23, 2019 - WISCONSIN STATE JOURNAL**  
**JULY 16 & JULY 23, 2019 - THE DAILY REPORTER**



# DANE COUNTY DEPARTMENT of PUBLIC WORKS, HIGHWAY and TRANSPORTATION

County Executive  
Joseph T. Parisi

1919 Alliant Energy Center Way ♦ Madison, Wisconsin 53713  
Phone: (608) 266-4018 ♦ FAX: (608) 267-1533

Commissioner / Director  
Gerald J. Mandli

## BEST VALUE CONTRACTING APPLICATION

### CONTRACTORS / LICENSURE APPLICANTS

The Dane County Department of Public Works requires all contractors to be pre-qualified as a best value contractor with the County prior to being awarded a contract. In addition, the County pre-qualifies potential contractors and sub-contractors who wish to work on County contracts. Subcontractors must become pre-qualified ten (10) days prior to commencing work under any Dane County Public Works Contract. Potential subcontractors are urged to become pre-qualified as early as possible. This document shall be completed, properly executed, along with the necessary attachments and additional information that the County requires for the protection and welfare of the public in the performance of a County contract.

Contractors or subcontractors of any tier who attain pre-qualification status will retain that status for a period of two (2) years from the date of qualification. Contractors shall notify the Dane County Department of Public Works, Highway & Transportation within fifteen (15) days of any changes to its business or operations that are relevant to the pre-qualification application. Failure to do so could result in suspension, revocation of the contractor's pre-qualification, debarment from County contracts for up to three (3) years and / or other sanctions available under the law.

No contracts will be awarded for construction work performed on Dane County projects unless the contractor is currently approved as a Wisconsin Trade Trainer or has applied for approval as an Apprenticeship Trade Trainer to the Wisconsin Department of Workforce Development and agrees to an acceptable apprenticeship program. If you are not currently approved as a Wisconsin Trade Trainer, or have not applied for approval as an Apprenticeship Trade Trainer, please contact the Department of Workforce Development - Bureau of Apprenticeship Standards at 608/266-3133 or visit their web site at: [dwd.wisconsin.gov/apprenticeship/](http://dwd.wisconsin.gov/apprenticeship/).

### EXEMPTIONS

- Contractors who employ less than five (5) apprenticeable trade workers are not required to pre-qualify.
- Contractors performing work that does not apply to an apprenticeable trade, as outlined in Appendix A.
- The contractor / subcontractor provides sufficient documentation to demonstrate one or more of the following:
  - apprentices are not available in a specific geographic area;
  - the applicable apprenticeship program is unsuitable or unavailable; or
  - there is a documented depression of the local construction market which prevents compliance.

SEC.	PROOF OF RESPONSIBILITY	CHECK IF APPLICABLE
1	Does your firm possess all technical qualifications and resources, including equipment, personnel and financial resources, necessary to perform the work required for any project or obtain the same through the use of responsible, pre-qualified subcontractors?	Yes: <input type="checkbox"/> No: <input type="checkbox"/>
2	Will your firm possess all valid, effective licenses, registrations or certificates required by federal, state, county, or local law, which are necessary for the type of work to be performed including, but not limited to, those for any type of trade work or specialty work?	Yes: <input type="checkbox"/> No: <input type="checkbox"/>
3	Will your firm meet all bonding requirements as required by applicable law or contract specifications?	Yes: <input type="checkbox"/> No: <input type="checkbox"/>
4	Will your firm meet all insurance requirements as required by applicable law or specifications, including general liability insurance, workers compensation insurance and unemployment insurance requirements?	Yes: <input type="checkbox"/> No: <input type="checkbox"/>
5	Will your firm maintain a substance abuse policy for employees hired for public works contracts that comply with Wis. Stats. Sec. 103.503?	Yes: <input type="checkbox"/> No: <input type="checkbox"/>
6	Does your firm acknowledge that it must pay all craft employees on public works projects the wage rates and benefits required under Section 66.0903 of the Wisconsin Statutes?	Yes: <input type="checkbox"/> No: <input type="checkbox"/>
7	Will your firm fully abide by the equal opportunity and affirmative action requirements of all applicable laws, including County ordinances?	Yes: <input type="checkbox"/> No: <input type="checkbox"/>
8	In the past three (3) years, has your firm had control or has another corporation, partnership or other business entity operating in the construction industry controlled it? If so, please attach a statement explaining the nature of the firm relationship?	Yes: <input type="checkbox"/> No: <input type="checkbox"/> If Yes, attach details.
9	In the past three (3) years, has your firm had any type of business, contracting or trade license, certification or registration revoked or suspended?	Yes: <input type="checkbox"/> No: <input type="checkbox"/> If Yes, attach details.
10	In the past three (3) years, has your firm been debarred by any federal, state or local government agency?	Yes: <input type="checkbox"/> No: <input type="checkbox"/> If Yes, attach details.
11	In the past three (3) years, has your firm defaulted or failed to complete any contract?	Yes: <input type="checkbox"/> No: <input type="checkbox"/> If Yes, attach details.
12	In the past three (3) years, has your firm committed a willful violation of federal, state or local government safety laws as determined by a final decision of a court or government agency authority.	Yes: <input type="checkbox"/> No: <input type="checkbox"/> If Yes, attach details.
13	In the past three (3) years, has your firm been in violation of any law relating to your contracting business where the penalty for such violation resulted in the imposition of a penalty greater than \$10,000?	Yes: <input type="checkbox"/> No: <input type="checkbox"/> If Yes, attach details.
14	Is your firm Executive Order 108 precertified with the State of Wisconsin?	Yes: <input type="checkbox"/> No: <input type="checkbox"/>
15	Is your firm an active Wisconsin Trade Trainer as determined by the Wisconsin Bureau of Apprenticeship Standards?	Yes: <input type="checkbox"/> No: <input type="checkbox"/>
16	Is your firm exempt from being pre-qualified with Dane County?	Yes: <input type="checkbox"/> No: <input type="checkbox"/> If Yes, attach reason for exemption.
17	Does your firm acknowledge that in doing work under any County Public Works Contract, it will be required to use as subcontractors only those contractors that are also pre-qualified with the County or become so ten days prior to commencing work?	Yes: <input type="checkbox"/> No: <input type="checkbox"/>
18	Contractor has been in business less than one year?	Yes: <input type="checkbox"/> No: <input type="checkbox"/>
19	Is your firm a first time Contractor requesting a one time exemption, but, intend to comply on all future contracts and are taking steps typical of a "good faith" effort?	Yes: <input type="checkbox"/> No: <input type="checkbox"/>
20	Not applicable. My firm does not intend to work on Best Value Contracts. Note: Best Value Contracting is required to bid on most Public Works Contracts (if unclear, please call Jan Neitzel Knox 608-266-4029).	Yes: <input type="checkbox"/> No: <input type="checkbox"/>

## SIGNATURE SECTION

Your firm's Officer, or the individual who would sign a bid and / or contract documents must sign this document.

I do hereby certify that all statements herein contained are true and correct to the best of my knowledge:

\_\_\_\_\_  
Signature

\_\_\_\_\_  
Date

\_\_\_\_\_  
Printed or Typed Name and Title

NAME AND ADDRESS OF CONTRACTOR	
Name of Firm:	
Address:	
City, State, Zip:	
Telephone Number:	
Fax Number:	
E-mail Address:	

## REMEMBER!

Return all to forms and attachments, or questions to:

**JAN NEITZEL KNOX**  
**EMAIL: NEITZEL-KNOX@COUNTYOFDANE.COM**  
**OFFICE: (608)266-4029, FAX: (608)267-1533**

**DANE COUNTY DEPARTMENT OF PUBLIC WORKS,  
HIGHWAY & TRANSPORTATION  
1919 ALLIANT ENERGY CENTER WAY  
MADISON, WI 53713**

# APPENDIX A

## APPRENTICEABLE TRADES

Bricklayer  
Carpenter  
Cement Mason (Concrete Finisher)  
Cement Mason (Heavy Highway)  
Construction Craft Laborer  
Data Communications Installer  
Electrician  
Elevator Mechanic / Technician  
Environmental Systems Technician / HVAC Service Technician / HVAC Install & Service  
Glazier  
Heavy Equipment Operator / Operating Engineer  
Insulation Worker (Heat & Frost)  
Iron Worker (Assembler, Metal Buildings)  
Painter / Decorator  
Plasterer  
Plumber  
Roofer / Waterproofer  
Sheet Metal Worker  
Sprinkler Fitter  
Steamfitter (Service & Refrigeration)  
Taper & Finisher  
Telecommunications (Voice, Data & Video) Installer / Technician  
Tile Setter

# INSTRUCTIONS TO BIDDERS

## TABLE OF CONTENTS

1. GENERAL.....	1
2. DRAWINGS AND SPECIFICATIONS .....	1
3. INTERPRETATION .....	2
4. QUALIFICATIONS OF BIDDER (CONTRACTOR AND SUBCONTRACTOR)....	2
5. BID GUARANTEE .....	3
6. WITHDRAWAL OF BIDS.....	3
7. CONTRACT FORM .....	3
8. CONTRACT INTERESTS BY COUNTY PUBLIC OFFICIALS .....	3
9. EMERGING SMALL BUSINESS PROVISIONS .....	4
10. METHOD OF AWARD - RESERVATIONS .....	5
11. SECURITY FOR PERFORMANCE AND PAYMENTS .....	6
12. TAXES.....	6
13. SUBMISSION OF BIDS .....	6
14. SUBCONTRACTOR LISTING.....	7
15. ALTERNATE BIDS .....	7
16. INFORMATIONAL BIDS .....	7
17. UNIT PRICES.....	7
18. COMMENCEMENT AND COMPLETION .....	8
19. WORK BY OWNER .....	8
20. SPECIAL HAZARDS COVERAGE.....	8
FORM A .....	9
FORM B.....	10
FORM C.....	11
FORM D .....	12

### **1. GENERAL**

- A. Before submitting Bid, bidder shall thoroughly examine all Construction Documents. Successful Bidder shall be required to provide all the Work that is shown on Drawings, set forth in Specifications, or reasonably implied as necessary to complete Contract for this project.
- B. Bidder shall visit site to become acquainted with adjacent areas, means of approach to site, conditions of actual site and facilities for delivering, storing, placing, and handling of materials and equipment.
- C. Pre-bid meeting is scheduled on July 30, 2019 at 10:00 a.m. at the Public Safety Building, 115 W Doty St., Madison, starting in the lobby. Attendance by all bidders is mandatory. Other subcontractors to bidders are encouraged to attend.
- D. Failure to visit site or failure to examine any and all Construction Documents will in no way relieve successful Bidder from necessity of furnishing any necessary materials or equipment, or performing any work, that may be required to complete the Work in accordance with Drawings and Specifications. Neglect of above requirements will not be accepted as reason for delay in the Work or additional compensation.

### **2. DRAWINGS AND SPECIFICATIONS**

- A. Drawings and Specifications that form part of this Contract, as stated in Article 1 of General Conditions of Contract, are enumerated in Document Index of these Construction Documents.



- B. Complete sets of Drawings and Specifications for all trades will be available to all Bidders, irrespective of category of work to be bid on, in order that all Bidders may be familiar with work of other trades as they affect their bid.

### **3. INTERPRETATION**

- A. No verbal explanation or instructions will be given in regard to meaning of Drawings or Specifications before Bid Due Date. Bidders shall bring inadequacies, omissions or conflicts to Owner or Architect / Engineer's attention at least ten (10) calendar days before Bid Due Date. Prompt clarification will be available to all bidders by Addendum.
- B. Failure to so request clarification or interpretation of Drawings and Specifications will not relieve successful Bidder of responsibility. Signing of Contract will be considered as implicitly denoting that Contractor has thorough understanding of scope of the Work and comprehension of Construction Documents.
- C. Owner or Architect / Engineer will not be responsible for verbal instructions.

### **4. QUALIFICATIONS OF BIDDER (CONTRACTOR AND SUBCONTRACTOR)**

- A. Before award of Contract can be approved, Owner shall be satisfied that Bidder involved meets following requirements:
  - 1. Has completed at least one (1) project of at least fifty percent (50%) of size or value of Division of work being bid and type of work completed is similar to that being bid. If greater magnitude of experience is deemed necessary, other than size or value of work, such requirements will be described in appropriate section of Specifications.
  - 2. Maintains permanent place of business.
  - 3. Can be bonded for terms of proposed Contract.
  - 4. Has record of satisfactorily completing past projects and supplies list of no more than three (3) most recent, similar projects, with architect or engineer's and owner's names, addresses and telephone numbers for each project. Submit to Public Works Project Manager with Bid, within three (3) business days after Bid Due Date, . Criteria which will be considered in determining satisfactory completion of projects by bidder will include:
    - a. Completed contracts in accordance with drawings and specifications.
    - b. Diligently pursued execution of work and completed contracts according to established time schedule unless Owner grants extensions.
    - c. Fulfilled guarantee requirements of construction documents.
    - d. Is not presently on ineligible list maintained by County's Department of Administration for noncompliance with equal employment opportunities and affirmative action requirements.
    - e. Authorized to conduct business in Wisconsin. By submitting Bid, bidder warrants that it has: complied with all necessary requirements to do business in State of Wisconsin; that persons executing contract on its behalf are authorized to do so; and, if corporation, that name and address of bidder's registered agent are as set forth in Contract. Bidder shall notify Owner immediately, in writing, of any change in its registered agent, their address, and bidder's legal status. For partnership, term "registered agent" shall mean general partner.

- B. County's Public Works Project Manager will make such investigations as are deemed necessary to determine ability of bidder to perform the Work, and bidder shall furnish to County's Public Works Project Manager or designee all such information and data for this purpose as County's Public Works Project Manager may request. Owner reserves right to reject Bid if evidence submitted by, or investigation of, bidder fails to satisfy Owner that bidder is responsible and qualified to carry out obligations of Contract and to complete the Work contemplated therein.

## **5. BID GUARANTEE**

- A. Bank certified check, cashier's check or Bid Bond, payable to County in amount not less than five percent (5%) of maximum bid, shall accompany each Bid as guarantee that if Bid is accepted, Bidder will execute and return proposed Contract and Performance and Payment Bonds within ten (10) business days after being notified of acceptance of Bid. Company issuing bonds must be licensed to do business in Wisconsin.
- B. Any bid, which is not accompanied by bid guarantee, will be considered "No Bid" and will not be read at Bid Due Date.
- C. If successful Bidder so delivers Contract, Certificate of Insurance, and Performance and Payment Bonds, check will be returned to Bidder. In case Bidder fails to deliver such Contract, insurance, and bond, amount of bid guarantee will be forfeited to County as liquidated damages.
- D. All checks tendered as bid guarantee, except those of three (3) lowest qualified, responsible bidders, will be returned to their makers within three (3) business days after Bid Due Date. All such retained checks will be returned immediately upon signing of Contract and Performance and Payment Bonds by successful Bidder.

## **6. WITHDRAWAL OF BIDS**

- A. Bids may be withdrawn by written request received from bidder or authorized representative thereof prior to time fixed for Bid Due Date, without prejudice to right of bidder to file new Bid. Withdrawn Bids will be returned unopened. Negligence on part of bidder in preparing their Bid confers no right for withdrawal of Bid after it has been opened.
- B. No Bid may be withdrawn for period of sixty (60) calendar days after Bid Due Date.
- C. If Bid contains error, omission or mistake, bidder may limit liability to amount of bidder's guarantee by giving written Notice of Intent not to execute Contract to Owner within seventy-two (72) hours of Bid Due Date.

## **7. CONTRACT FORM**

- A. Sample copy of contract that successful Bidder will be required to enter into is included in these Construction Documents and bidders are required to familiarize themselves with all conditions contained therein.

## **8. CONTRACT INTERESTS BY COUNTY PUBLIC OFFICIALS**

- A. In accordance with Wisconsin Statute 946.13, county official may not bid for or enter into any contract involving receipts or disbursements of more than \$15,000.00 in a year, in which they have private pecuniary interest, direct or indirect if at same time they are authorized to take official action with respect to making of this Contract. Any contract entered into in violation of this Statute is void and County incurs no liability thereon. This subsection does

not affect application and enforcement of Wisconsin Statute 946.13 by state prosecutors in criminal courts of this state.

## **9. EMERGING SMALL BUSINESS PROVISIONS**

A. **Emerging Small Business Definition.** For purposes of this provision, ESB is defined as:

1. Independent business concern that has been in business minimum of one year;
2. Business located in State of Wisconsin;
3. Business comprised of less than twenty-five (25) employees;
4. Business must not have gross sales in excess of three million dollars (\$3,000,000.00) over past three years; and
5. Business does not have history of failing to complete projects.

B. **Emerging Small Business (ESB) Involvement.** Bidder shall make good faith effort to award minimum of ten percent (10%) of the Work to ESBs. Bidder shall submit report to Dane County Contract Compliance Officer within ten (10) business days of Bid Due Date demonstrating such efforts. Good faith efforts means significant contact with ESBs for purposes of soliciting bids from them. Failure to make or demonstrate good faith efforts will be grounds for disqualification.

C. **Emerging Small Business Report.** Emerging Small Business Enterprise Report is to be submitted by Bidder in separate envelope marked "Emerging Small Business Report". This report is due by 2:00 p.m. following specified ten (10) business days after Bid Due Date. Bidder who fails to submit Emerging Small Business Report shall be deemed not responsive.

D. **ESB Goal.** Goal of this project is ten percent (10%) ESB participation. ESB utilizations are shown as percentage of total Bid. If Bidder meets or exceeds specified goal, Bidder is only required to submit Form A - Certification, and Form B - Involvement. Goal shall be met if Bidder qualifies as ESB.

E. **Report Contents.** Following award of Contract, Bidder shall submit copies of executed contracts for all Emerging Small Businesses. Emerging Small Business Report shall consist of these:

1. Form A - Certification;
2. Form B - Involvement;
3. Form C - Contacts;
4. Form D - Certification Statement (if appropriate); and
5. Supportive documentation (i.e., copies of correspondence, telephone logs, copies of advertisements).

F. **ESB Listing.** Bidders may solicit bids from this ESB listing: [pdf.countyofdane.com/commissions/2013-2015\\_Targeted\\_Business\\_Directory.pdf](http://pdf.countyofdane.com/commissions/2013-2015_Targeted_Business_Directory.pdf).

G. **ESB Certification.** All contractors, subcontractors and suppliers seeking ESB certification must complete and submit Emerging Small Business Report to Dane County Contract Compliance Program.

H. **Certification Statement.** If ESB firm has not been certified by County as ESB prior to submittal of this Bid, ESB Report cannot be used to fulfill ESB goal for this project unless firm provides "Form D - Certification Statement". Certification statement must be completed and signed by ESB firm.

I. **Questions.** Questions concerning Emerging Small Business provisions shall be directed to:

Dane County Contract Compliance Officer  
City-County Building, Room 421  
210 Martin Luther King, Jr. Blvd.  
Madison, WI 53703  
608/266-5623

J. **Substituting ESBs.** In event of any significant changes in subcontract arrangements or if need arises to substitute ESBs, Bidder shall report such proposed changes to Contract Compliance Officer to making any official changes and request authorization to substitute ESB firm. Bidder further agrees to make every possible effort to replace ESB firm with another qualified ESB firm.

K. **Good Faith Efforts.** Good faith efforts can be demonstrated by meeting all of these obligations:

1. Selecting portions of the Work to be performed by ESBs in order to increase likelihood of meeting ESB goal including, where appropriate, breaking down Contract into smaller units to facilitate ESB participation.
2. Advertising in general circulation, trade associations and women / minority focus media concerning subcontracting opportunities.
3. Providing written notices to reasonable number of specific ESBs that their interest in Contract was being solicited in sufficient time to allow ESBs to participate effectively.
4. Following up on initial solicitations of interest by contacting ESBs within five (5) business days prior to Bid Due Date to determine with certainty whether ESB were interested, to allow ESBs to prepare bids.
5. Providing interested ESB with adequate information about Drawings, Specifications and requirements of Contract.
6. Using services of available minority, women and small business organizations and other organizations that provide assistance in recruitment of MBEs / WBEs / ESBs.
7. Negotiating in good faith with interested ESBs, not rejecting ESBs as unqualified without sound reason based on thorough investigation of their capabilities.
8. Submitting required project reports and accompanying documents to County's Contract Compliance Officer within twenty-four (24) hours after Bid Due Date.

L. **Appeals Disqualification of Bid.** Bidder who is disqualified may appeal to Public Works & Transportation Committee and Equal Opportunity Commission.

## 10. METHOD OF AWARD - RESERVATIONS

A. Following will be basis of award of Contract, providing cost does not exceed amount of funds then estimated by County as available to finance Contract(s):

1. Lowest dollar amount submitted by qualified responsible bidder on Base Bid for all work comprising project, combined with such additive Owner accepted alternates.
2. Owner reserves right to reject all bids or any bid, to waive any informality in any bid, and to accept any bid that will best serve interests of County.
3. Unit Prices and Informational Bids will not be considered in establishing low bidder.

## **11. SECURITY FOR PERFORMANCE AND PAYMENTS**

- A. Simultaneous with delivery of signed Contract, Bidder shall be required to furnish Performance and Payment Bonds as specified in Article 29 of General Conditions of Contract, "Contract Security" Surety Company shall be licensed to do business in Wisconsin. Performance and Payment Bonds must be dated same date or subsequent to date of Contract. Performance and Payment Bonds must emulate information in Sample Performance and Payment Bonds in Construction Documents.
- B. Provide certified copy of power of attorney from Surety Company showing that agent who signs Bond has power of attorney to sign for Surety Company. Secretary or Assistant Secretary of company must sign this certification, not attorney-in-fact. Certification must bear same or later date as Bond. Power of Attorney must emulate model power of attorney information detailed in Sample Performance and Payment Bonds.
- C. If Bidder is partnership or joint venture, State certified list, providing names of individuals constituting partnership or joint venture must be furnished. Contract itself may be signed by one partner of partnership, or one partner of each firm comprising joint venture, but Performance and Payment Bonds must be signed by all partners.
- D. If Bidder is corporation, it is necessary that current certified copy of resolution or other official act of directors of corporation be submitted showing that person who signs Contract is authorized to sign contracts for corporation. It is also necessary that corporate seal be affixed to resolution, contract, and performance and payment bonds. If your corporation has no seal, it is required that above documents include statement or notation to effect that corporation has no seal.

## **12. TAXES**

- A. Wisconsin Statute 77.54 (9m) allows building materials that become part of local unit government facilities to be exempt from sales & use tax. Vendors & materials suppliers may not charge Bidders sales & use tax on these purchases. This does not include highways, streets or roads. Any other Sales, Consumer, Use & other similar taxes or fees required by law shall be included in Bid.
- B. In accordance with Wisconsin Statute 71.80(16)(a), successful nonresident bidder, whether incorporated or not, and not otherwise regularly engaged in business in this state, shall file surety bond with State of Wisconsin Department of Revenue payable to Department of Revenue, to guarantee payment of income taxes, required unemployment compensation contributions, sales and use taxes and income taxes withheld from wages of employees, together with any penalties and interest thereon. Amount of bond shall be three percent (3%) of Contract or subcontract price on all contracts of \$50,000 or more.

## **13. SUBMISSION OF BIDS**

- A. All Bids shall be submitted on standard Bid Form bound herein and only Bids that are made on this Bid Form will be considered. Entire Bid Form and other supporting documents, if

any, shall be removed or copied from Construction Documents, filled out, and submitted in manner specified hereinafter. Submit completed Bid Bond with Bid as well.

- B. No bids for any subdivision or any sub-classification of this Work, except as indicated, will be accepted. Any conditional Bid, amendment to Bid Form or appended item thereto, or inclusion of any correspondence, written or printed matter, or details of any nature other than that specifically called for, which would alter any essential provision of Construction Documents, or require consideration of unsolicited material or data in determining award of Contract, will disqualify Bid. Telecommunication alterations to Bid will not be accepted.
- C. Bidders must submit single Bid for all the Work.
- D. Bid amounts shall be inserted in words and in figures in spaces provided on Bid Form; in case of conflict, written word amounts will govern.
- E. Addenda issued after Bid Letting shall become part of Construction Documents. Bidders shall acknowledge receipt of such addenda in appropriate space provided on Bid Form. Bid may be rejected if receipt of any particular addendum applicable to award of Contract has not been acknowledged on Bid Form.
- F. Bids shall be signed, placed in envelope, sealed and delivered before due time to place designated in Invitation to Bid, and identified with project name, bid number, location, category of work being bid upon, Bid Due Date, name and address of bidder.
- G. Bidder shall be responsible for sealed Bid being delivered to place designated for Bid Due Date on or before date and time specified. Bids received after time of closing will be rejected and returned to bidder unopened.
- H. Bid will be considered invalid and will be rejected if bidder has not signed it.
- I. Faxed or emailed Bids will not be accepted.
- J. Bidder's organization shall submit completed with Bid, Fair Labor Practices Certification form, included in these Construction Documents.

#### **14. SUBCONTRACTOR LISTING**

- A. Bidders shall be required to submit list of major subcontractors for General Construction, Plumbing, HVAC, and Electrical work proposed for this project to include committed prices for each subcontractor. List shall be placed in separate sealed envelope that must be clearly identified as "Major Subcontractor List", for named project and name of Bidder submitting it. County must receive envelope no later than date by which successful Bidder is required to submit his or her signed Contract, as established in Construction Documents.

#### **15. ALTERNATE BIDS**

- A. Not Applicable.

#### **16. INFORMATIONAL BIDS**

- A. Not Applicable.

#### **17. UNIT PRICES**

- A. Not Applicable.

**18. COMMENCEMENT AND COMPLETION**

- A. Successful Bidder shall commence work when schedule and weather permit, but no later than stated in Bid Form. Contractor shall pursue the Work regularly and continuously at reasonable rate to insure completion of the Work within time stated in Bid.
- B. Should it be found impossible to complete the Work on or before time specified for completion, written request may be submitted for extension of time setting forth reasons believed to justify granting of such request. Refer to Article 20 of General Conditions of Contract, titled "Time for Completion".

**19. WORK BY OWNER**

- A. Not Applicable.

**20. SPECIAL HAZARDS COVERAGE**

- A. Not Applicable.

**FORM A**

**DANE COUNTY  
EMERGING SMALL BUSINESS REPORT - CERTIFICATION**

In accordance with General Conditions of Contract, submit this Emerging Small Business Report within ten (10) days after Bid Due Date.

PROJECT NAME: \_\_\_\_\_

\_\_\_\_\_

BID NO.: \_\_\_\_\_ BID DUE DATE: \_\_\_\_\_

**BIDDER INFORMATION**

COMPANY NAME: \_\_\_\_\_

ADDRESS: \_\_\_\_\_

\_\_\_\_\_

TELEPHONE NO.: \_\_\_\_\_

CONTACT PERSON: \_\_\_\_\_

EMAIL ADDRESS: \_\_\_\_\_



**FORM B**

Page \_\_\_ of \_\_\_

**DANE COUNTY**

(Copy this Form as necessary to provide complete information)

**EMERGING SMALL BUSINESS REPORT - INVOLVEMENT**

COMPANY NAME: \_\_\_\_\_

PROJECT NAME: \_\_\_\_\_

BID NO.: \_\_\_\_\_ BID DUE DATE: \_\_\_\_\_

ESB NAME: \_\_\_\_\_

CONTACT PERSON: \_\_\_\_\_

ADDRESS: \_\_\_\_\_

PHONE NO & EMAIL.: \_\_\_\_\_

Indicate percentage of financial commitment to this ESB: \_\_\_\_\_ % Amount: \$ \_\_\_\_\_

ESB NAME: \_\_\_\_\_

CONTACT PERSON: \_\_\_\_\_

ADDRESS: \_\_\_\_\_

PHONE NO & EMAIL.: \_\_\_\_\_

Indicate percentage of financial commitment to this ESB: \_\_\_\_\_ % Amount: \$ \_\_\_\_\_

**FORM C**

Page \_\_\_ of \_\_\_

**DANE COUNTY  
EMERGING SMALL BUSINESS REPORT - CONTACTS**

(Copy this Form as necessary to provide complete information)

COMPANY NAME: \_\_\_\_\_

PROJECT NAME: \_\_\_\_\_

BID NO.: \_\_\_\_\_ BID DUE DATE: \_\_\_\_\_

	<u>ESB FIRM NAME CONTACTED</u>	<u>DATE</u>	<u>PERSON CONTACTED</u>	<u>DID ESB BID?</u>	<u>ACC- EPT BID?</u>	<u>REASON FOR REJECTION</u>
1)	_____	_____	_____	_____	_____	_____
2)	_____	_____	_____	_____	_____	_____
3)	_____	_____	_____	_____	_____	_____
4)	_____	_____	_____	_____	_____	_____
5)	_____	_____	_____	_____	_____	_____
6)	_____	_____	_____	_____	_____	_____
7)	_____	_____	_____	_____	_____	_____
8)	_____	_____	_____	_____	_____	_____

**FORM D**

**DANE COUNTY  
EMERGING SMALL BUSINESS REPORT - CERTIFICATION STATEMENT**

I, \_\_\_\_\_, \_\_\_\_\_ of  
Name Title

\_\_\_\_\_ certify to best of my knowledge and  
Company

belief that this business meets Emerging Small Business definition as indicated in Article 9 and  
that information contained in this Emerging Small Business Report is true and correct.

\_\_\_\_\_  
Bidder's Signature

\_\_\_\_\_  
Date

Name of Bidding Firm: \_\_\_\_\_

**BID FORM**

**BID NO. 318066**

**PROJECT: PUBLIC SAFETY BUILDING ROOF REPLACEMENT  
DANE COUNTY PUBLIC SAFETY BUILDING**

**TO: DANE COUNTY DEPARTMENT OF PUBLIC WORKS, HIGHWAY &  
TRANSPORTATION PROJECT MANAGER  
1919 ALLIANT ENERGY CENTER WAY  
MADISON, WISCONSIN 53713**

**NOTE: WISCONSIN STATUTE 77.54 (9M) ALLOWS FOR NO SALES & USE TAX ON  
THE PURCHASE OF MATERIALS FOR COUNTY PUBLIC WORKS PROJECTS.**

**BASE BID - LUMP SUM:**

Dane County is inviting Bids for construction services to replace the roof on the Public Safety Building. The undersigned, having examined the site where the Work is to be executed and having become familiar with local conditions affecting the cost of the Work and having carefully examined the Drawings and Specifications, all other Construction Documents and Addenda thereto prepared by Dane County Department of Public Works, Highway & Transportation hereby agrees to provide all labor, materials, equipment and services necessary for the complete and satisfactory execution of the entire Work, as specified in the Construction Documents, for the Base Bid stipulated sum of:

\_\_\_\_\_ and \_\_\_\_\_ /100 Dollars  
Written Price

\$ \_\_\_\_\_  
Numeric Price

Numeric Price (circle: Add or Deduct)

Receipt of the following addenda and inclusion of their provisions in this Bid is hereby acknowledged:

Addendum No(s). \_\_\_\_\_ through \_\_\_\_\_

Dated \_\_\_\_\_

Dane County Department of Administration must have this project completed by December 13 2019. Assuming this Work can be started by October 15, 2019, what dates can you commence and complete this job?

Commencement Date: \_\_\_\_\_ Completion Date: \_\_\_\_\_  
(final, not substantial)

I hereby certify that all statements herein are made on behalf of:

---

(Name of Corporation, Partnership or Person submitting Bid)

Select one of the following:

1. A corporation organized and existing under the laws of the State of \_\_\_\_\_, or
  2. A partnership consisting of \_\_\_\_\_, or
  3. A person conducting business as \_\_\_\_\_;
- Of the City, Village, or Town of \_\_\_\_\_ of the State of \_\_\_\_\_.

I have examined and carefully prepared this Bid from the associated Construction Documents and have checked the same in detail before submitting this Bid; that I have full authority to make such statements and submit this Bid in (its) (their) (my) behalf; and that the said statements are true and correct. In signing this Bid, we also certify that we have not, either directly or indirectly, entered into any agreement or participated in any collusion or otherwise taken any action in restraint of free competition; that no attempt has been made to induce any other person or firm to submit or not to submit a Bid; that this Bid has been independently arrived at without collusion with any other bidder, competitor, or potential competitor; that this Bid has not been knowingly disclosed prior to the Bids Due Date to another bidder or competitor; that the above statement is accurate under penalty of perjury.

The undersigned agrees to be qualified as a Best Value Contractor or will have proven their exemption before the award of this contract.

The undersigned further agrees to honor the Base Bid and the Alternate Bid(s) for sixty (60) calendar days from date of Award of Contract.

**SIGNATURE:** \_\_\_\_\_  
(Bid is invalid without signature)

Print Name: \_\_\_\_\_ Date: \_\_\_\_\_

Title: \_\_\_\_\_

Address: \_\_\_\_\_

Telephone No.: \_\_\_\_\_ Fax No.: \_\_\_\_\_

Email Address: \_\_\_\_\_

Contact Person: \_\_\_\_\_

**THIS PAGE IS FOR BIDDERS' REFERENCE AND NEED NOT BE SUBMITTED WITH BID FORM.**

**BID CHECK LIST:**

These items **must** be included with Bid:

Bid Form

Bid Bond

Fair Labor Practices Certification

**DANE COUNTY BEST VALUE CONTRACTING PRE-QUALIFICATION**

General Contractors & all Subcontractors must be pre-qualified as a Best Value Contractor with the Dane County Public Works Engineering Division before the award of contract. Qualification & listing is not permanent & must be renewed every 24 months. Obtain a *Best Value Contracting Application* by calling 608/266-4018 or complete one online at:

[countyofdane.com/pwht/BVC\\_Application.aspx](http://countyofdane.com/pwht/BVC_Application.aspx)

**DANE COUNTY VENDOR REGISTRATION PROGRAM**

All bidders are strongly encouraged to be a registered vendor with Dane County. Registering allows vendors an opportunity to receive notifications for RFBs & RFPs issued by the County and provides the County with up-to-date company contact information. Complete a new form or renewal online at:

[danepurchasing.com/Account/Login?](http://danepurchasing.com/Account/Login?)

**FAIR LABOR PRACTICES CERTIFICATION**

The undersigned, for and on behalf of the BIDDER, APPLICANT or PROPOSER named herein, certifies as follows:

- A. That he or she is an officer or duly authorized agent of the above-referenced BIDDER, APPLICANT or PROPOSER, which has submitted a bid, application or proposal for a contract or agreement with the county of Dane.
  
- B. That BIDDER, APPLICANT or PROPOSER has (check one):

\_\_\_\_\_ not been found by the National Labor Relations Board (“NLRB”) or the Wisconsin Employment Relations Commission (“WERC”) to have violated any statute or regulation regarding labor standards or relations in the seven years prior to the signature date of this Certification.

\_\_\_\_\_ been found by the National Labor Relations Board (“NLRB”) or the Wisconsin Employment Relations Commission (“WERC”) to have violated any statute or regulation regarding labor standards or relations in the seven years prior to the signature date of this Certification.

\_\_\_\_\_  
Officer or Authorized Agent Signature Date

\_\_\_\_\_  
Printed or Typed Name and Title

\_\_\_\_\_  
Printed or Typed Business Name

**NOTE:** You can find information regarding the violations described above at: [www.nlr.gov](http://www.nlr.gov) and [werc.wi.gov](http://werc.wi.gov).

For reference, Dane County Ordinance 25.09 is as follows:

- (1) BIDDER RESPONSIBILITY. (a) Any bid, application or proposal for any contract with the county, including public works contracts regulated under chapter 40, shall include a certification indicating whether the bidder has been found by the National Labor Relations Board (NLRB) or the Wisconsin Employment Relations Committee (WERC) to have violated any statute or regulation regarding labor standards or relations within the last seven years. The Controller shall investigate any such finding and make a recommendation to the committee, which shall determine whether the conduct resulting in the finding affects the bidder’s responsibility to perform the contract.

**If you indicated that the NLRB or WERC have found you to have such a violation, you must include copies of any relevant information regarding such violation with your proposal, bid or application.**

Include this completed Certification with your bid, application or proposal.



**COUNTY OF DANE**

**PUBLIC WORKS CONSTRUCTION CONTRACT**

Contract No. \_\_\_\_\_ Bid No. 318066

Authority: 2018 RES - \_\_\_\_\_

**THIS CONTRACT**, made and entered into as of the date by which authorized representatives of both parties have affixed their signatures, by and between the County of Dane (hereafter referred to as "COUNTY") and \_\_\_\_\_ (hereafter, "CONTRACTOR"), and

**WITNESSETH:**

**WHEREAS**, COUNTY, whose address is c/o Todd Draper, 1919 Alliant Energy Center Way, Madison, WI 53713, desires to have CONTRACTOR provide Dane County Public Safety Building Roof Replacement ("the Project"); and

**WHEREAS**, CONTRACTOR, whose address is \_\_\_\_\_ is able and willing to construct the Project, in accordance with the [Construction Documents, Scope of Work document, site meeting, etc.];

**NOW, THEREFORE**, in consideration of the above premises and the mutual covenants of the parties hereinafter set forth, the receipt and sufficiency of which is acknowledged by each party for itself, COUNTY and CONTRACTOR do agree as follows:

1. CONTRACTOR agrees to construct, for the price of \$ \_\_\_\_\_ the Project and at the CONTRACTOR'S own proper cost and expense to furnish all materials, supplies, machinery, equipment, tools, superintendence labor, insurance, and other accessories and services necessary to complete the Project in accordance with the conditions and prices stated in the [Bid Form, Quote], [General Conditions of Contract, Conditions of Contract], the drawings which include all maps, plats, plans, and other drawings and printed or written explanatory matter thereof, and the specifications therefore as prepared by \_\_\_\_\_ (hereinafter referred to as "the Architect / Engineer"), and as enumerated in the Project Manual Table of Contents, all of which are made a part hereof and collectively evidence and constitute the Contract.

2. COUNTY agrees to pay the CONTRACTOR in current funds for the performance of the Contract subject to additions and deductions, as provided in the [General Conditions of Contract, Conditions of Contract], and to make payments on account thereof as provided in Article entitled, "Payments to Contractor" of the [General Conditions of Contract, Conditions of Contract].

3. During the term of this Contract, CONTRACTOR agrees to take affirmative action to ensure equal employment opportunities. The CONTRACTOR agrees in accordance with Wisconsin Statute 111.321 and Chapter 19 of the Dane County Code of Ordinances not to discriminate on the basis of age, race, ethnicity, religion, color, gender, disability, marital status, sexual orientation, national origin, cultural differences, ancestry, physical appearance, arrest record or conviction record, military participation or membership in the national guard, state defense force or any other reserve component of the military forces of the United States, or political beliefs. Such equal opportunity shall include, but not be limited to, the following: employment,

upgrading, demotion, transfer, recruitment, advertising, layoff, termination, training, rates of pay, and any other form of compensation. CONTRACTOR agrees to post in conspicuous places, available to all employees and applicants for employment, notices setting forth the provisions of this paragraph.

**4.** CONTRACTOR shall file an Affirmative Action Plan with the Dane County Contract Compliance Officer in accord with Chapter 19 of the Dane County Code of Ordinances. CONTRACTOR must file such plan within fifteen (15) business days of the effective date of this Contract. During the term of this Contract CONTRACTOR shall also provide copies of all announcements of employment opportunities to COUNTY'S Contract Compliance Office, and shall report annually the number of persons, by race, ethnicity, gender, and disability status, which apply for employment and, similarly classified, the number hired and number rejected.

**5.** During the term of this Contract, all solicitations for employment placed on CONTRACTOR'S behalf shall include a statement to the effect that CONTRACTOR is an "Equal Opportunity Employer".

**6.** CONTRACTOR agrees to furnish all information and reports required by COUNTY'S Contract Compliance Officer as the same relate to affirmative action and nondiscrimination, which may include any books, records, or accounts deemed appropriate to determine compliance with Chapter 19, Dane County Code of Ordinances, and the provisions of this Contract.

**7.** This Contract is intended to be a Contract solely between the parties hereto and for their benefit only. No part of this Contract shall be construed to add to, supplement, amend, abridge or repeal existing rights, benefits or privileges of any third party or parties including, but not limited to, employees of either of the parties.

**8.** The entire agreement of the parties is contained herein and this Contract supersedes any and all oral agreements and negotiations between the parties relating to the subject matter hereof. The parties expressly agree that the express terms of this Contract shall not be amended in any fashion except in writing, executed by both parties.

**9.** CONTRACTOR must be pre-qualified as a Best Value Contractor with Dane County Public Works Engineering Division before award of Contract. Subcontractors must be pre-qualified ten (10) business days prior to commencing Work under this Contract.

**IN WITNESS WHEREOF**, COUNTY and CONTRACTOR, by their respective authorized agents, have caused this Contract and its Schedules to be executed, effective as of the date by which all parties hereto have affixed their respective signatures, as indicated below.

\* \* \* \* \*

**FOR CONTRACTOR:**

\_\_\_\_\_  
Signature Date

\_\_\_\_\_  
Printed or Typed Name and Title

\_\_\_\_\_  
Signature Date

\_\_\_\_\_  
Printed or Typed Name and Title

**NOTE:** If CONTRACTOR is a corporation, Secretary should attest. In accordance with IRS Regulations, unincorporated entities are required to provide either their Social Security or Employer Number in order to receive payment for services rendered.

\* \* \* \* \*

This Contract is not valid or effectual for any purpose until approved by the appropriate authority designated below, and no work is authorized until the CONTRACTOR has been given notice to proceed by COUNTY'S Assistant Public Works Director.

**FOR COUNTY:**

\_\_\_\_\_  
Joseph T. Parisi, County Executive Date

\_\_\_\_\_  
Scott McDonell, County Clerk Date

# AIA<sup>®</sup> Document A310<sup>™</sup> – 2010

## Bid Bond

**CONTRACTOR:**

(Name, legal status and address)

**SURETY:**

(Name, legal status and principal place of business)

**OWNER:**

(Name, legal status and address)

**BOND AMOUNT:****PROJECT:**

(Name, location or address, and Project number, if any)

This document has important legal consequences. Consultation with an attorney is encouraged with respect to its completion or modification.

Any singular reference to Contractor, Surety, Owner or other party shall be considered plural where applicable.

The Contractor and Surety are bound to the Owner in the amount set forth above, for the payment of which the Contractor and Surety bind themselves, their heirs, executors, administrators, successors and assigns, jointly and severally, as provided herein. The conditions of this Bond are such that if the Owner accepts the bid of the Contractor within the time specified in the bid documents, or within such time period as may be agreed to by the Owner and Contractor, and the Contractor either (1) enters into a contract with the Owner in accordance with the terms of such bid, and gives such bond or bonds as may be specified in the bidding or Contract Documents, with a surety admitted in the jurisdiction of the Project and otherwise acceptable to the Owner, for the faithful performance of such Contract and for the prompt payment of labor and material furnished in the prosecution thereof; or (2) pays to the Owner the difference, not to exceed the amount of this Bond, between the amount specified in said bid and such larger amount for which the Owner may in good faith contract with another party to perform the work covered by said bid, then this obligation shall be null and void, otherwise to remain in full force and effect. The Surety hereby waives any notice of an agreement between the Owner and Contractor to extend the time in which the Owner may accept the bid. Waiver of notice by the Surety shall not apply to any extension exceeding sixty (60) days in the aggregate beyond the time for acceptance of bids specified in the bid documents, and the Owner and Contractor shall obtain the Surety's consent for an extension beyond sixty (60) days.

If this Bond is issued in connection with a subcontractor's bid to a Contractor, the term Contractor in this Bond shall be deemed to be Subcontractor and the term Owner shall be deemed to be Contractor.

When this Bond has been furnished to comply with a statutory or other legal requirement in the location of the Project, any provision in this Bond conflicting with said statutory or legal requirement shall be deemed deleted herefrom and provisions conforming to such statutory or other legal requirement shall be deemed incorporated herein. When so furnished, the intent is that this Bond shall be construed as a statutory bond and not as a common law bond.

Signed and sealed this \_\_\_\_\_ day of \_\_\_\_\_

_____	(Contractor as Principal)	_____	(Seal)
(Witness)	_____	_____	(Title)
_____	(Surety)	_____	(Seal)
(Witness)	_____	_____	(Title)

**CAUTION:** You should sign an original AIA Contract Document, on which this text appears in RED. An original assures that changes will not be obscured.

# AIA<sup>®</sup> Document A312<sup>™</sup> – 2010

## Performance Bond

**CONTRACTOR:**

(Name, legal status and address)

**SURETY:**

(Name, legal status and principal place of business)

**OWNER:**

(Name, legal status and address)

**CONSTRUCTION CONTRACT**

Date:

Amount:

Description:

(Name and location)

**BOND**

Date:

(Not earlier than Construction Contract Date)

Amount:

Modifications to this Bond:  None  See Section 16

**CONTRACTOR AS PRINCIPAL**

Company: (Corporate Seal)

**SURETY**

Company: (Corporate Seal)

Signature: \_\_\_\_\_

Name \_\_\_\_\_  
and Title: \_\_\_\_\_

(Any additional signatures appear on the last page of this Performance Bond.)

Signature: \_\_\_\_\_

Name \_\_\_\_\_  
and Title: \_\_\_\_\_

(FOR INFORMATION ONLY — Name, address and telephone)

**AGENT or BROKER:**

**OWNER'S REPRESENTATIVE:**

(Architect, Engineer or other party:)

This document has important legal consequences. Consultation with an attorney is encouraged with respect to its completion or modification.

Any singular reference to Contractor, Surety, Owner or other party shall be considered plural where applicable.

AIA Document A312–2010 combines two separate bonds, a Performance Bond and a Payment Bond, into one form. This is not a single combined Performance and Payment Bond.

§ 1 The Contractor and Surety, jointly and severally, bind themselves, their heirs, executors, administrators, successors and assigns to the Owner for the performance of the Construction Contract, which is incorporated herein by reference.

§ 2 If the Contractor performs the Construction Contract, the Surety and the Contractor shall have no obligation under this Bond, except when applicable to participate in a conference as provided in Section 3.

§ 3 If there is no Owner Default under the Construction Contract, the Surety's obligation under this Bond shall arise after

- .1 the Owner first provides notice to the Contractor and the Surety that the Owner is considering declaring a Contractor Default. Such notice shall indicate whether the Owner is requesting a conference among the Owner, Contractor and Surety to discuss the Contractor's performance. If the Owner does not request a conference, the Surety may, within five (5) business days after receipt of the Owner's notice, request such a conference. If the Surety timely requests a conference, the Owner shall attend. Unless the Owner agrees otherwise, any conference requested under this Section 3.1 shall be held within ten (10) business days of the Surety's receipt of the Owner's notice. If the Owner, the Contractor and the Surety agree, the Contractor shall be allowed a reasonable time to perform the Construction Contract, but such an agreement shall not waive the Owner's right, if any, subsequently to declare a Contractor Default;
- .2 the Owner declares a Contractor Default, terminates the Construction Contract and notifies the Surety; and
- .3 the Owner has agreed to pay the Balance of the Contract Price in accordance with the terms of the Construction Contract to the Surety or to a contractor selected to perform the Construction Contract.

§ 4 Failure on the part of the Owner to comply with the notice requirement in Section 3.1 shall not constitute a failure to comply with a condition precedent to the Surety's obligations, or release the Surety from its obligations, except to the extent the Surety demonstrates actual prejudice.

§ 5 When the Owner has satisfied the conditions of Section 3, the Surety shall promptly and at the Surety's expense take one of the following actions:

§ 5.1 Arrange for the Contractor, with the consent of the Owner, to perform and complete the Construction Contract;

§ 5.2 Undertake to perform and complete the Construction Contract itself, through its agents or independent contractors;

§ 5.3 Obtain bids or negotiated proposals from qualified contractors acceptable to the Owner for a contract for performance and completion of the Construction Contract, arrange for a contract to be prepared for execution by the Owner and a contractor selected with the Owner's concurrence, to be secured with performance and payment bonds executed by a qualified surety equivalent to the bonds issued on the Construction Contract, and pay to the Owner the amount of damages as described in Section 7 in excess of the Balance of the Contract Price incurred by the Owner as a result of the Contractor Default; or

§ 5.4 Waive its right to perform and complete, arrange for completion, or obtain a new contractor and with reasonable promptness under the circumstances:

- .1 After investigation, determine the amount for which it may be liable to the Owner and, as soon as practicable after the amount is determined, make payment to the Owner; or
- .2 Deny liability in whole or in part and notify the Owner, citing the reasons for denial.

§ 6 If the Surety does not proceed as provided in Section 5 with reasonable promptness, the Surety shall be deemed to be in default on this Bond seven days after receipt of an additional written notice from the Owner to the Surety demanding that the Surety perform its obligations under this Bond, and the Owner shall be entitled to enforce any remedy available to the Owner. If the Surety proceeds as provided in Section 5.4, and the Owner refuses the payment or the Surety has denied liability, in whole or in part, without further notice the Owner shall be entitled to enforce any remedy available to the Owner.



§ 7 If the Surety elects to act under Section 5.1, 5.2 or 5.3, then the responsibilities of the Surety to the Owner shall not be greater than those of the Contractor under the Construction Contract, and the responsibilities of the Owner to the Surety shall not be greater than those of the Owner under the Construction Contract. Subject to the commitment by the Owner to pay the Balance of the Contract Price, the Surety is obligated, without duplication, for

- .1 the responsibilities of the Contractor for correction of defective work and completion of the Construction Contract;
- .2 additional legal, design professional and delay costs resulting from the Contractor's Default, and resulting from the actions or failure to act of the Surety under Section 5; and
- .3 liquidated damages, or if no liquidated damages are specified in the Construction Contract, actual damages caused by delayed performance or non-performance of the Contractor.

§ 8 If the Surety elects to act under Section 5.1, 5.3 or 5.4, the Surety's liability is limited to the amount of this Bond.

§ 9 The Surety shall not be liable to the Owner or others for obligations of the Contractor that are unrelated to the Construction Contract, and the Balance of the Contract Price shall not be reduced or set off on account of any such unrelated obligations. No right of action shall accrue on this Bond to any person or entity other than the Owner or its heirs, executors, administrators, successors and assigns.

§ 10 The Surety hereby waives notice of any change, including changes of time, to the Construction Contract or to related subcontracts, purchase orders and other obligations.

§ 11 Any proceeding, legal or equitable, under this Bond may be instituted in any court of competent jurisdiction in the location in which the work or part of the work is located and shall be instituted within two years after a declaration of Contractor Default or within two years after the Contractor ceased working or within two years after the Surety refuses or fails to perform its obligations under this Bond, whichever occurs first. If the provisions of this Paragraph are void or prohibited by law, the minimum period of limitation available to sureties as a defense in the jurisdiction of the suit shall be applicable.

§ 12 Notice to the Surety, the Owner or the Contractor shall be mailed or delivered to the address shown on the page on which their signature appears.

§ 13 When this Bond has been furnished to comply with a statutory or other legal requirement in the location where the construction was to be performed, any provision in this Bond conflicting with said statutory or legal requirement shall be deemed deleted herefrom and provisions conforming to such statutory or other legal requirement shall be deemed incorporated herein. When so furnished, the intent is that this Bond shall be construed as a statutory bond and not as a common law bond.

#### § 14 Definitions

§ 14.1 **Balance of the Contract Price.** The total amount payable by the Owner to the Contractor under the Construction Contract after all proper adjustments have been made, including allowance to the Contractor of any amounts received or to be received by the Owner in settlement of insurance or other claims for damages to which the Contractor is entitled, reduced by all valid and proper payments made to or on behalf of the Contractor under the Construction Contract.

§ 14.2 **Construction Contract.** The agreement between the Owner and Contractor identified on the cover page, including all Contract Documents and changes made to the agreement and the Contract Documents.

§ 14.3 **Contractor Default.** Failure of the Contractor, which has not been remedied or waived, to perform or otherwise to comply with a material term of the Construction Contract.

§ 14.4 **Owner Default.** Failure of the Owner, which has not been remedied or waived, to pay the Contractor as required under the Construction Contract or to perform and complete or comply with the other material terms of the Construction Contract.

§ 14.5 **Contract Documents.** All the documents that comprise the agreement between the Owner and Contractor.

§ 15 If this Bond is issued for an agreement between a Contractor and subcontractor, the term Contractor in this Bond shall be deemed to be Subcontractor and the term Owner shall be deemed to be Contractor.

§ 16 Modifications to this bond are as follows:

Sample

*(Space is provided below for additional signatures of added parties, other than those appearing on the cover page.)*

**CONTRACTOR AS PRINCIPAL**

**SURETY**

Company: \_\_\_\_\_

*(Corporate Seal)*

Company: \_\_\_\_\_

*(Corporate Seal)*

Signature: \_\_\_\_\_

Name and Title: \_\_\_\_\_

Address \_\_\_\_\_

Signature: \_\_\_\_\_

Name and Title: \_\_\_\_\_

Address \_\_\_\_\_

**CAUTION: You should sign an original AIA Contract Document, on which this text appears in RED. An original assures that changes will not be obscured.**





# AIA® Document A312™ – 2010

## Payment Bond

**CONTRACTOR:**

*(Name, legal status and address)*

**SURETY:**

*(Name, legal status and principal place of business)*

**OWNER:**

*(Name, legal status and address)*

This document has important legal consequences. Consultation with an attorney is encouraged with respect to its completion or modification.

Any singular reference to Contractor, Surety, Owner or other party shall be considered plural where applicable.

AIA Document A312–2010 combines two separate bonds, a Performance Bond and a Payment Bond, into one form. This is not a single combined Performance and Payment Bond.

**CONSTRUCTION CONTRACT**

Date:

Amount:

Description:

*(Name and location)*

**BOND**

Date:

*(Not earlier than Construction Contract Date)*

Amount:

Modifications to this Bond:  None  See Section 18

**CONTRACTOR AS PRINCIPAL**

Company: *(Corporate Seal)*

**SURETY**

Company: *(Corporate Seal)*

Signature: \_\_\_\_\_

Name \_\_\_\_\_  
and Title: \_\_\_\_\_

Signature: \_\_\_\_\_

Name \_\_\_\_\_  
and Title: \_\_\_\_\_

*(Any additional signatures appear on the last page of this Payment Bond.)*

*(FOR INFORMATION ONLY — Name, address and telephone)*

**AGENT or BROKER:****OWNER'S REPRESENTATIVE:**

*(Architect, Engineer or other party:)*

§ 1 The Contractor and Surety, jointly and severally, bind themselves, their heirs, executors, administrators, successors and assigns to the Owner to pay for labor, materials and equipment furnished for use in the performance of the Construction Contract, which is incorporated herein by reference, subject to the following terms.

§ 2 If the Contractor promptly makes payment of all sums due to Claimants, and defends, indemnifies and holds harmless the Owner from claims, demands, liens or suits by any person or entity seeking payment for labor, materials or equipment furnished for use in the performance of the Construction Contract, then the Surety and the Contractor shall have no obligation under this Bond.

§ 3 If there is no Owner Default under the Construction Contract, the Surety's obligation to the Owner under this Bond shall arise after the Owner has promptly notified the Contractor and the Surety (at the address described in Section 13) of claims, demands, liens or suits against the Owner or the Owner's property by any person or entity seeking payment for labor, materials or equipment furnished for use in the performance of the Construction Contract and tendered defense of such claims, demands, liens or suits to the Contractor and the Surety.

§ 4 When the Owner has satisfied the conditions in Section 3, the Surety shall promptly and at the Surety's expense defend, indemnify and hold harmless the Owner against a duly tendered claim, demand, lien or suit.

§ 5 The Surety's obligations to a Claimant under this Bond shall arise after the following:

§ 5.1 Claimants, who do not have a direct contract with the Contractor,

- .1 have furnished a written notice of non-payment to the Contractor, stating with substantial accuracy the amount claimed and the name of the party to whom the materials were, or equipment was, furnished or supplied or for whom the labor was done or performed, within ninety (90) days after having last performed labor or last furnished materials or equipment included in the Claim; and
- .2 have sent a Claim to the Surety (at the address described in Section 13).

§ 5.2 Claimants, who are employed by or have a direct contract with the Contractor, have sent a Claim to the Surety (at the address described in Section 13).

§ 6 If a notice of non-payment required by Section 5.1.1 is given by the Owner to the Contractor, that is sufficient to satisfy a Claimant's obligation to furnish a written notice of non-payment under Section 5.1.1.

§ 7 When a Claimant has satisfied the conditions of Sections 5.1 or 5.2, whichever is applicable, the Surety shall promptly and at the Surety's expense take the following actions:

§ 7.1 Send an answer to the Claimant, with a copy to the Owner, within sixty (60) days after receipt of the Claim, stating the amounts that are undisputed and the basis for challenging any amounts that are disputed; and

§ 7.2 Pay or arrange for payment of any undisputed amounts.

§ 7.3 The Surety's failure to discharge its obligations under Section 7.1 or Section 7.2 shall not be deemed to constitute a waiver of defenses the Surety or Contractor may have or acquire as to a Claim, except as to undisputed amounts for which the Surety and Claimant have reached agreement. If, however, the Surety fails to discharge its obligations under Section 7.1 or Section 7.2, the Surety shall indemnify the Claimant for the reasonable attorney's fees the Claimant incurs thereafter to recover any sums found to be due and owing to the Claimant.

§ 8 The Surety's total obligation shall not exceed the amount of this Bond, plus the amount of reasonable attorney's fees provided under Section 7.3, and the amount of this Bond shall be credited for any payments made in good faith by the Surety.

§ 9 Amounts owed by the Owner to the Contractor under the Construction Contract shall be used for the performance of the Construction Contract and to satisfy claims, if any, under any construction performance bond. By the Contractor furnishing and the Owner accepting this Bond, they agree that all funds earned by the Contractor in the performance of the Construction Contract are dedicated to satisfy obligations of the Contractor and Surety under this Bond, subject to the Owner's priority to use the funds for the completion of the work.

§ 10 The Surety shall not be liable to the Owner, Claimants or others for obligations of the Contractor that are unrelated to the Construction Contract. The Owner shall not be liable for the payment of any costs or expenses of any Claimant under this Bond, and shall have under this Bond no obligation to make payments to, or give notice on behalf of, Claimants or otherwise have any obligations to Claimants under this Bond.

§ 11 The Surety hereby waives notice of any change, including changes of time, to the Construction Contract or to related subcontracts, purchase orders and other obligations.

§ 12 No suit or action shall be commenced by a Claimant under this Bond other than in a court of competent jurisdiction in the state in which the project that is the subject of the Construction Contract is located or after the expiration of one year from the date (1) on which the Claimant sent a Claim to the Surety pursuant to Section 5.1.2 or 5.2, or (2) on which the last labor or service was performed by anyone or the last materials or equipment were furnished by anyone under the Construction Contract, whichever of (1) or (2) first occurs. If the provisions of this Paragraph are void or prohibited by law, the minimum period of limitation available to sureties as a defense in the jurisdiction of the suit shall be applicable.

§ 13 Notice and Claims to the Surety, the Owner or the Contractor shall be mailed or delivered to the address shown on the page on which their signature appears. Actual receipt of notice or Claims, however accomplished, shall be sufficient compliance as of the date received.

§ 14 When this Bond has been furnished to comply with a statutory or other legal requirement in the location where the construction was to be performed, any provision in this Bond conflicting with said statutory or legal requirement shall be deemed deleted herefrom and provisions conforming to such statutory or other legal requirement shall be deemed incorporated herein. When so furnished, the intent is that this Bond shall be construed as a statutory bond and not as a common law bond.

§ 15 Upon request by any person or entity appearing to be a potential beneficiary of this Bond, the Contractor and Owner shall promptly furnish a copy of this Bond or shall permit a copy to be made.

#### § 16 Definitions

§ 16.1 Claim. A written statement by the Claimant including at a minimum:

- .1 the name of the Claimant;
- .2 the name of the person for whom the labor was done, or materials or equipment furnished;
- .3 a copy of the agreement or purchase order pursuant to which labor, materials or equipment was furnished for use in the performance of the Construction Contract;
- .4 a brief description of the labor, materials or equipment furnished;
- .5 the date on which the Claimant last performed labor or last furnished materials or equipment for use in the performance of the Construction Contract;
- .6 the total amount earned by the Claimant for labor, materials or equipment furnished as of the date of the Claim;
- .7 the total amount of previous payments received by the Claimant; and
- .8 the total amount due and unpaid to the Claimant for labor, materials or equipment furnished as of the date of the Claim.

§ 16.2 Claimant. An individual or entity having a direct contract with the Contractor or with a subcontractor of the Contractor to furnish labor, materials or equipment for use in the performance of the Construction Contract. The term Claimant also includes any individual or entity that has rightfully asserted a claim under an applicable mechanic's lien or similar statute against the real property upon which the Project is located. The intent of this Bond shall be to include without limitation in the terms "labor, materials or equipment" that part of water, gas, power, light, heat, oil, gasoline, telephone service or rental equipment used in the Construction Contract, architectural and engineering services required for performance of the work of the Contractor and the Contractor's subcontractors, and all other items for which a mechanic's lien may be asserted in the jurisdiction where the labor, materials or equipment were furnished.

§ 16.3 Construction Contract. The agreement between the Owner and Contractor identified on the cover page, including all Contract Documents and all changes made to the agreement and the Contract Documents.

§ 16.4 **Owner Default.** Failure of the Owner, which has not been remedied or waived, to pay the Contractor as required under the Construction Contract or to perform and complete or comply with the other material terms of the Construction Contract.

§ 16.5 **Contract Documents.** All the documents that comprise the agreement between the Owner and Contractor.

§ 17 If this Bond is issued for an agreement between a Contractor and subcontractor, the term Contractor in this Bond shall be deemed to be Subcontractor and the term Owner shall be deemed to be Contractor.

§ 18 Modifications to this bond are as follows:

*(Space is provided below for additional signatures of added parties, other than those appearing on the cover page.)*

**CONTRACTOR AS PRINCIPAL**

Company: \_\_\_\_\_

(Corporate Seal)

**SURETY**

Company: \_\_\_\_\_

(Corporate Seal)

Signature: \_\_\_\_\_

Name and Title: \_\_\_\_\_

Address \_\_\_\_\_

Signature: \_\_\_\_\_

Name and Title: \_\_\_\_\_

Address \_\_\_\_\_

**CAUTION: You should sign an original AIA Contract Document, on which this text appears in RED. An original assures that changes will not be obscured.**

## GENERAL CONDITIONS OF CONTRACT

### TABLE OF CONTENTS

1. CONSTRUCTION DOCUMENTS .....	2
2. DEFINITIONS .....	2
3. ADDITIONAL INSTRUCTIONS AND DRAWINGS .....	2
4. SHOP DRAWINGS, PRODUCT DATA AND SAMPLES .....	3
5. CUTTING AND PATCHING.....	3
6. CLEANING UP .....	4
7. USE OF SITE.....	4
8. MATERIALS AND WORKMANSHIP .....	5
9. CONTRACTOR'S TITLE TO MATERIALS .....	5
10. "OR EQUAL" CLAUSE.....	5
11. PATENTS AND ROYALTIES.....	6
12. SURVEYS, PERMITS, REGULATIONS AND TAXES.....	6
13. CONTRACTOR'S OBLIGATIONS AND SUPERINTENDENCE.....	7
14. WEATHER CONDITIONS .....	8
15. PROTECTION OF WORK AND PROPERTY .....	8
16. INSPECTION AND TESTING OF MATERIALS .....	8
17. REPORTS, RECORDS AND DATA .....	9
18. CHANGES IN THE WORK .....	9
19. EXTRAS .....	10
20. TIME FOR COMPLETION.....	10
21. CORRECTION OF WORK.....	10
22. SUBSURFACE CONDITIONS FOUND DIFFERENT .....	10
23. RIGHT OF DEPARTMENT TO TERMINATE CONTRACT .....	11
24. CONSTRUCTION SCHEDULE AND PERIODIC ESTIMATES .....	11
25. PAYMENTS TO CONTRACTOR .....	12
26. WITHHOLDING OF PAYMENTS.....	13
27. ACCEPTANCE OF FINAL PAYMENT AS RELEASE .....	14
28. PAYMENTS BY CONTRACTOR.....	14
29. CONTRACT SECURITY .....	14
30. ASSIGNMENTS.....	14
31. MUTUAL RESPONSIBILITY OF CONTRACTORS .....	14
32. SEPARATE CONTRACTS .....	15
33. SUBCONTRACTS .....	15
34. PUBLIC WORKS PROJECT MANAGER'S AUTHORITY .....	15
35. ARCHITECT / ENGINEER'S AUTHORITY .....	16
36. STATED ALLOWANCES .....	16
37. ESTIMATES OF QUANTITIES .....	16
38. LANDS AND RIGHTS-OF-WAY .....	17
39. GENERAL GUARANTEE.....	18
40. CONFLICTING CONDITIONS .....	18
41. NOTICE AND SERVICE THEREOF .....	18
42. PROTECTION OF LIVES AND HEALTH .....	19
43. AFFIRMATIVE ACTION PROVISION AND MINORITY / WOMEN / DISADVANTAGED BUSINESS ENTERPRISES .....	19
44. COMPLIANCE WITH FAIR LABOR STANDARDS .....	20
45. DOMESTIC PARTNERSHIP BENEFITS .....	20
46. USE AND OCCUPANCY PRIOR TO ACCEPTANCE .....	20
47. MINIMUM WAGES .....	20
48. CLAIMS .....	20
49. ANTITRUST AGREEMENT .....	21
50. INSURANCE.....	21
51. WISCONSIN LAW CONTROLLING .....	23



## **1. CONSTRUCTION DOCUMENTS**

- A. Construction Documents, listed in Table of Contents of this Specification volume shall form part of this Contract and provisions of Construction Documents shall be as binding upon parties as if they were fully set forth in Contract itself.
- B. These shall also be considered as part of Construction Documents: Addenda, including additions and modifications incorporated in such addenda before execution of Contract; requests for information; construction bulletins; change orders; and written interpretations by Architect / Engineer or Public Works Project Manager that are made after execution of Contract.
- C. Construction Documents are complementary, and what is required by one shall be as binding as if required by all. Intent of Construction Documents is to include all labor, materials and equipment necessary for proper execution of the Work.

## **2. DEFINITIONS**

- A. These terms as used in this Contract are respectively defined as follows:
  - 1. All uses of term “County” in Construction Documents shall mean Dane County.
  - 2. All uses of term “Department” in Construction Documents shall mean Department of Public Works, Highway & Transportation, which is a unit of Dane County government. Department is County agency overseeing Contract with Contractor.
  - 3. Public Works Project Manager is appointed by and responsible to Department. Public Works Project Manager has authority to act on behalf of Department and will sign change orders, payment requests and other administrative matters related to projects.
  - 4. Public Works Project Manager is responsible for supervision, administration and management of field operations involved in construction phase of this Work.
  - 5. Term “Work” includes all labor, equipment and materials necessary to produce project required by Construction Documents.
  - 6. Term “Substantial Completion” is date when project or specified area of project is certified by Architect / Engineer that construction is sufficiently completed, in accordance with Construction Documents, and as modified by any subsequent changes agreed to by parties, so that County may occupy project or specified area of project for use for which it was intended subject to permit approval for occupancy.
  - 7. Contractor is person, firm, or corporation with whom County makes Contract. Though multiple contracts may be involved, Construction Documents treat them throughout as if each were of singular number.

## **3. ADDITIONAL INSTRUCTIONS AND DRAWINGS**

- A. Contractor may be furnished additional instructions and detail drawings as necessary to carry out the Work included in Contract. Additional drawings and instructions thus supplied to Contractor will coordinate with Construction Documents and will be so prepared that they can be reasonably interpreted as part thereof. Contractor shall carry out the Work in accordance with additional detail drawings and instructions.

#### **4. SHOP DRAWINGS, PRODUCT DATA AND SAMPLES**

- A. Unless otherwise specified, Contractor shall submit three (3) copies of all Shop Drawings for each submission, until receiving final approval. After final approval, provide five (5) additional copies for distribution and such other copies as may be required.
- B. Contractor shall submit, on an on-going basis and as directed, Product Data such as brochures that shall contain catalog cuts and specifications of all furnished mechanical and electrical equipment. After Architect / Engineer's approval, one (1) copy shall remain in Architect / Engineer's file, one (1) kept at Department's office and one (1) kept at job site by Contractor for reference purposes.
- C. Samples shall consist of physical examples furnished by Contractor in sufficient size and quantity to illustrate materials, equipment or workmanship, and to establish standards to compare the Work.
  - 1. Submit Samples in sufficient quantity (minimum of two (2)) to permit Architect / Engineer to make all necessary tests and of adequate size showing quality, type, color range, finish, and texture. Label each Sample stating material, type, color, thickness, size, project name, and Contractor's name.
  - 2. Submit transmittal letter requesting approval, and prepay transportation charges to Architect / Engineer's office on samples forwarded.
  - 3. Materials installed shall match approved Samples.
- D. Contractor shall review Shop Drawings and place their dated stamp thereon to evidence their review and approval and shall submit with reasonable promptness and in orderly sequence to cause no delay in the Work or in work of any other contractor. At time of submission, Contractor shall inform Architect / Engineer in writing of any deviation in Shop Drawings or Samples from requirements of Construction Documents. Architect / Engineer will not consider partial lists.
- E. Architect / Engineer will review and approve or reject Shop Drawings with reasonable promptness to cause no delay. Architect / Engineer's approval shall not relieve Contractor from responsibility for errors or omissions in Shop Drawings.
- F. Contractor shall not commence any work requiring Shop Drawing, Product Data or Sample submission until Architect / Engineer has approved submission. All such work shall be in accordance with approved Shop Drawings, Product Data and Samples.
- G. Contractor shall keep on site of the Work, approved or conformed copy of Shop Drawings and shall at all times give Department access thereto.
- H. By stamping and submitting Shop Drawings, Product Data and Samples, Contractor thereby represents that he or she has or will determine and verify all field measurements, field construction criteria, materials, catalog numbers, and similar data and that he or she has checked and coordinated each Shop Drawing, Product Data and Sample with requirements of the Work and of Construction Documents. Architect / Engineer shall return without examination, Shop Drawings, Product Data and Samples not so noted.
- I. All Shop Drawings from any one Contractor should be numbered consecutively and on cover sheet shall bear name and location of project, name of Contractor, date of submittal and date of each correction or revision and associated Specification section and page number.

#### **5. CUTTING AND PATCHING**

- A. Contractor shall be responsible for all cutting, fitting or patching required to complete the Work or to make its parts fit together properly.
- B. Contractor shall not damage or endanger portion of the Work or fully or partially completed construction of County or separate contractors by cutting, patching or otherwise altering such construction, or by excavation. Contractor shall not cut or otherwise alter such construction by County or separate contractor except with written consent of County and of such separate contractor; such consent shall not be unreasonably withheld. Contractor shall not withhold unreasonably from County or separate contractor, Contractor's consent to cutting or otherwise altering the Work.

## **6. CLEANING UP**

- A. Contractor shall keep premises and surrounding area free from accumulation of waste materials or rubbish caused by operations under Contract. Contractor shall remove from and about the Work waste materials, rubbish, Contractor's tools, construction equipment, machinery, and surplus materials at completion of the Work. Contractor shall maintain streets and sidewalks around the Work site in clean condition. Contractor shall remove all spillage and prevent tracking of spillage arising from performance of the Work, into, out of, and within the Work site. Contractor shall establish regular maintenance program of sweeping, vacuuming and / or hosing to minimize accumulation of dirt and dust upon such areas.
- B. If Contractor fails to clean up as directed in Construction Documents, County may do so and shall charge Contractor cost thereof.
- C. Contractor shall be responsible for broken windows and glass, and at completion of the Work shall replace such damaged or broken windows and glass. After replacing damaged or broken windows and glass, Contractor shall remove all labels, wash and polish both sides of all windows and glass.
- D. In addition to general cleaning (sweeping, vacuuming and / or hosing, as is appropriate to work surface), Contractor shall perform following final cleaning for all trades at completion of the Work:
  - 1. Remove temporary protections;
  - 2. Remove marks, stains, fingerprints and other soil or dirt from painted, decorated and finished woodwork and wall surfaces;
  - 3. Remove spots, plaster, soil and paint from ceramic tile, marble and other finished materials, and wash or wipe clean;
  - 4. Clean fixtures, cabinet work and equipment, removing stains, paint, dirt and dust, and leave same in undamaged, new condition;
  - 5. Clean aluminum in accordance with recommendations of manufacturer; and
  - 6. Clean resilient floors thoroughly with well-rinsed mop containing only enough moisture to clean off any surface dirt or dust and buff dry by machine to bring surfaces to sheen.

## **7. USE OF SITE**

- A. Contractor shall provide County and Architect / Engineer access to the Work under all circumstances.
- B. Contractor shall confine operations at site to areas permitted by County, law, ordinance, permits and Construction Documents and shall not unreasonably encumber site with materials



or equipment. Contractor shall assure free, convenient, unencumbered, direct and safe access to all properties adjacent to the Work for County, its employees, invitees and guests.

## **8. MATERIALS AND WORKMANSHIP**

- A. Contractor shall perform all work and furnish all supplies and materials, machinery, equipment, facilities and means, necessary to complete the Work required by this Contract, within time specified, in accordance with provisions of Construction Documents.
- B. All equipment and materials incorporated in the Work covered by this Contract are to be new; use recycled and / or recovered materials to extent that such use is technically and economically feasible. Recovered materials are products recovered from solid waste in form identical to original form for use that is same as, or similar to original use. Recycled materials are products manufactured from solid waste.
- C. If requested, Contractor shall furnish satisfactory evidence as to kind and quality of construction materials proposed or used. Contractor shall furnish to Architect / Engineer, for approval, manufacturer name and model, performance capacities and other pertinent information of machinery, mechanical, electrical or other types of equipment, which Contractor plans to install.
- D. If not otherwise provided, materials and labor called for in this Contract shall be provided and performed in accordance with established practice and standards recognized by Architects, Engineers, Department, and construction industry.
- E. Reference to "Standard" specifications of any association or manufacturer, or codes of County authorities, intends most recent printed edition or catalog in effect on date that corresponds with date of Construction Documents.
- F. Whenever reference is made in Specifications that work shall be "performed", "applied", in accordance with "manufacturer's directions or instructions", Contractor to whom those instructions are directed shall furnish three (3) printed copies of such instructions to Architect / Engineer before execution of the Work.

## **9. CONTRACTOR'S TITLE TO MATERIALS**

- A. Contractor or any subcontractor shall not purchase materials or supplies for the Work subject to any chattel mortgage or under conditional sale contract or other agreement by which seller retains interest. Contractor warrants that all materials and supplies used in the Work are free from all liens, claims or encumbrances and Contractor has good title to them.

## **10. "OR EQUAL" CLAUSE**

- A. Whenever equipment or materials are identified on Drawings or in Specifications by reference to manufacturer's or vendor's name, trade name, catalog number, and other identifying information, it is intended to establish standards; and any equipment or material of other manufacturers and vendors which will perform adequately duties imposed by general design will be considered equally accepted provided equipment or material so proposed is, in opinion of Architect / Engineer, of equal substance and function. Architect / Engineer and Department shall provide written approval before Contractor may purchase or install it.

- B. Equipment or materials of manufacturers, other than those named, may be used only upon following conditions:
1. That, in opinion of Architect / Engineer and Department, proposed material or equipment item is fully equal or superior (in design, materials, construction, workmanship, performance, finish, etc.) to named item. No compromise in quality level, however small, is acceptable.
  2. That, in substituting materials or equipment, Contractor assumes responsibility for any changes in system or for modifications required in adjacent or related work to accommodate such substitution despite Architect / Engineer's and Department's approval, and all costs growing out of approval of "or equal" items shall be responsibility of Contractor. No extra costs resulting from such approval shall become responsibility of Department, Architect / Engineer or any other separate Contractor.
  3. It shall be understood that use of materials or equipment other than those specified, or approved equal by Architect / Engineer and Department, shall constitute violation of Contract, and that Architect / Engineer and Department shall have right to require removal of such materials or equipment and their replacement with specified materials or equipment at Contractor's expense.
  4. Product and manufacturer named first in Specifications or on information shown on Drawings is basis of selection of manufactured items and equipment, particularly mechanical equipment. In using other than first named products or manufacturers, including those specified as additionally approved or acceptable, Contractor assumes responsibility for any changes in system and for modifications in any work required to accommodate them. Architect / Engineer's approval of such additionally acceptable products or manufacturers, either in Specifications or in Addendum, does not relieve Contractor from obligation to coordinate such optional products with other Contractors, whose work may be affected by them, and to pay all additional costs resulting from their inclusion into the Work. Contractor's liability shall include payment of Architect / Engineer's fees for any additional services made necessary by or directly connected to such product changes. No extra costs resulting from such changes shall become responsibility of Department, Architect / Engineer or any other separate Contractor.
- C. No request for approval of "or equal" materials will be entertained except from Contractor. Identify any request for substitution as substitution on Contractor's letter of transmittal and give reasons for substitution. Department may in its sole discretion allow substitutions of materials.

## **11. PATENTS AND ROYALTIES**

- A. If Contractor uses any design, device or material covered by letters, patent or copyright, it is mutually agreed and understood, that, without exception, contract prices shall include all royalties or costs arising from use of such design, device or materials, in any way involved in the Work.
- B. Contractor shall indemnify and save harmless County from any and all claims for infringement by reason of use of such patent or copyright in connection with the Work agreed to be performed under this Contract, and shall indemnify County for any cost, expense or damage which it may be obliged to pay by reason of such infringement at any time during prosecution of the Work or after completion of the Work.

## **12. SURVEYS, PERMITS, REGULATIONS AND TAXES**

- A. Department will furnish to Contractor all site, topography and property surveys necessary for execution of the Work.

- B. Contractor shall procure all permits, licenses and approvals necessary for execution of this Contract.
- C. Contractor shall give all notices and comply with all State of Wisconsin, Federal and local laws, codes, rules and regulations relating to performance of the Work, protection of adjacent property, and maintenance of passageways, guard fences or other protective facilities.
- D. Contractor does not need to pay State and local sales & use taxes. See Wisconsin Statute 77.54 (9m).
- E. Contractor shall promptly notify Architect / Engineer of any variances of Drawings or Specifications with that of any State of Wisconsin, federal or local law, code, rule or regulation. Upon such notification, Architect / Engineer will require correction of variance to comply with applicable law, code, rule or regulation at no additional cost to Contractor.
- F. Work under this Contract shall comply with all applicable State of Wisconsin, Federal and local laws, codes and regulations.
- G. Contractor shall pay charges for water, sewer and other utility connections made by municipalities where required by Specifications.

### **13. CONTRACTOR'S OBLIGATIONS AND SUPERINTENDENCE**

- A. Contractor shall provide and pay for all materials, labor, tools, equipment, transportation and superintendence necessary to execute, complete and deliver the Work within specified time. Contractor agrees to secure at their own expense all personnel necessary to carry out the Work. Such personnel shall not be deemed County employees nor shall they have or be deemed to have any direct contractual relationship with County.
- B. Performance of any work necessary after regular working hours, on Sundays or Legal Holidays shall be without additional expense to County. Performance of any work at site at other than normal working hours must be coordinated with Public Works Project Manager.
- C. Contractor shall furnish, erect, maintain and remove such temporary works as may be required.
- D. Contractor shall observe, comply with, and be subject to all terms, conditions, requirements and limitations of Construction Documents.
- E. At the Work site, Contractor shall give personal superintendence to the Work or shall employ construction superintendent or foreman, experienced in character of work covered by Contract, who shall have full authority to act for Contractor. Understand that such superintendent or foreman shall be acceptable to Architect / Engineer and Department.
- F. Remove from project or take other corrective action upon notice from Architect / Engineer or Department for Contractor's employees whose work is considered by Architect / Engineer or Department to be unsatisfactory, careless, incompetent, unskilled or otherwise objectionable.
- G. Contractor and subcontractors shall be required to conform to Labor Laws of State of Wisconsin and various acts amendatory and supplementary thereto and to other laws, ordinances and legal requirements applicable to the Work.

- H. Presence and observation of the Work by Architect / Engineer or Public Works Project Manager shall not relieve Contractor of any obligations.

#### **14. WEATHER CONDITIONS**

- A. In event of temporary suspension of work, or during inclement weather, or whenever Architect / Engineer shall direct, Contractor shall, and shall cause subcontractors to protect carefully all work and materials against damage or injury from weather. If, in opinion of Architect / Engineer or Department, any work or materials that have been damaged or injured due to failure on part of Contractor or any subcontractors so to protect the Work, such materials shall be removed and replaced at expense of Contractor.

#### **15. PROTECTION OF WORK AND PROPERTY**

- A. Contractor shall at all times safely guard County's property from injury or loss in connection with this Contract. Contractor shall at all times safely guard and protect the Work, and adjacent property, from damage. Contractor shall replace or make good any such damage, loss or injury unless such is caused directly by errors contained in Contract, or by County, or County's duly authorized representative.
- B. Contractor may act diligently, without previous instructions from Architect / Engineer and / or Department, in emergency that threatens loss or injury of property, or safety of life. Contractor shall notify Architect / Engineer and / or Department immediately thereafter. Promptly submit any claim for compensation by Contractor due to such extra work to Architect / Engineer and / or Department for approval as provided for in Article 18 herein.

#### **16. INSPECTION AND TESTING OF MATERIALS**

- A. Authorized representatives and agents of County government shall have access at all times to the Work wherever it is in preparation or progress and Contractor shall provide facilities for such access and for inspection.
- B. Should it be considered necessary or advisable at any time before final acceptance of the Work to make examination of work already completed, by removing or tearing out same, Contractor shall upon request, promptly furnish all necessary facilities, labor and materials. If such work is found to be defective in any aspect, due to fault of Contractor or subcontractors thereof, Contractor shall assume all expenses of such examination and of satisfactory reconstruction. Contractor will be reimbursed for such examination and replacement in accordance with Article 18 - A.3., of these General Conditions of Contract if such work is found to meet requirements of Contract.
- C. If Specifications, Architect / Engineer's, or Public Works Project Manager's instructions require any work to be specially tested or approved, Contractor shall give Architect / Engineer and Public Works Project Manager timely notice of its readiness for testing or inspection. Test all materials and equipment requiring testing in accordance with accepted or specified standards, as applicable. Architect / Engineer shall recommend laboratory or inspection agency and Department will select and pay for all initial laboratory inspection services. Should retesting be required, due to failure of initial testing, cost of such retesting shall be borne by Contractor.
- D. Cost of any testing performed by manufacturers or Contractor for substantiating acceptability of proposed substitution of materials and equipment, or necessary conformance testing in

conjunction with manufacturing processes or factory assemblage, shall be borne by Contractor or manufacturer responsible.

## **17. REPORTS, RECORDS AND DATA**

- A. Contractor shall submit to Architect / Engineer and Public Works Project Manager such schedule of quantities and costs, progress schedules, payrolls, reports, estimates, invoices, records and other data as either may request concerning work performed or to be performed under this Contract.

## **18. CHANGES IN THE WORK**

- A. Make no changes, except in cases of emergency, in the Work covered by approved Construction Documents without having prior written approval of Department. Charges or credits for the Work covered by approved change shall be determined by one of these methods:
1. Unit bid prices previously approved.
  2. Agreed lump sum based on actual cost of:
    - a) Labor, including foremen, and all fringe benefits that are associated with their wages.
    - b) Materials entering permanently into the Work.
    - c) Ownership or rental cost of construction tools and equipment during time of use on extra work.
    - d) Power and consumable supplies for operation of power equipment.
    - e) Workmen's Compensation Insurance, Contractor's Public Liability and Property Damage Insurance, and Comprehensive Automobile Liability Insurance.
    - f) Social Security and old age and unemployment contributions.
    - g) Add to cost under (2), fixed fee to be agreed upon, but not to exceed fifteen percent (15%) of actual cost of work performed with their own labor force. Fee shall be compensation to cover cost of supervision, overhead, bond, profit and any other general expense.
    - h) On that portion of the Work under (2) done under subcontract, Contractor may include not over seven and one-half percent (7½%) for supervision, overhead, bond, profit and any other general expense.
    - i) Department may require correct amount of costs with supporting vouchers; Contractor shall keep and present in such form as directed.
  3. Cost-plus work, with not-to-exceed dollar limit, based on actual cost of:
    - a) Labor, including foremen, and all fringe benefits that are associated with their wages.
    - b) Materials entering permanently into the Work.
    - c) Ownership or rental cost of construction tools and equipment during time of use on extra work. Rental cost cannot exceed fifty percent (50%) replacement value of rented equipment.
    - d) Power and consumable supplies for operation of power equipment.
    - e) Workmen's Compensation Insurance, Contractor's Public Liability and Property Damage Insurance, and Comprehensive Automobile Liability Insurance.
    - f) Social Security and old age and unemployment contributions.
    - g) To cost under (3), there shall be added fixed fee to be agreed upon but not to exceed fifteen percent (15%) of actual cost of work performed with their own labor force. Fee shall be compensation to cover cost of supervision, overhead, bond, profit, and any other general expense.
    - h) On that portion of the Work under (3) done under subcontract, Contractor may include not over seven and one-half percent (7½%) for supervision, overhead, bond, profit, and any other general expense.

- i) Contractor shall keep and present, in such form as directed, correct amount of cost together with such supporting vouchers as may be required by Department.
- B. If Contractor claims that by any instructions given by Architect / Engineer, Department, by drawings or otherwise, regarding performance of the Work or furnishing of material under Contract, involves extra cost, Contractor shall give Department written notice of cost thereof within two (2) weeks after receipt of such instructions and in any event before proceeding to execute work, unless delay in executing work would endanger life or property.
- C. No claim for extra work or cost shall be allowed unless it was done in pursuance of written Change Order from Architect / Engineer and approved by Department, as previously mentioned, and claim presented with payment request submitted after changed or extra work is completed.
- D. Negotiation of cost for change in the Work shall not be cause for Contractor to delay prosecution of the Work if Contractor has been authorized in writing by Public Works Project Manager to proceed.

## **19. EXTRAS**

- A. Without invalidating Contract, Department may order extra work or make changes by altering, adding to or deducting from the Work, contract sum being adjusted in accordance with Article 18 herein.

## **20. TIME FOR COMPLETION**

- A. Contractor agrees that the Work shall be prosecuted regularly and diligently and complete the Work as stated in Construction Documents.

## **21. CORRECTION OF WORK**

- A. All work, all materials whether incorporated in the Work or not, and all processes of manufacture shall at all times and places be subject to inspection of Architect / Engineer and Public Works Project Manager who shall be judge of quality and suitability of the Work, materials, and processes of manufacture for purposes for which they are used. Should they fail to meet Architect / Engineer's and Public Works Project Manager's approval they shall be reconstructed, made good, replaced or corrected, by Contractor at Contractor's expense. Immediately remove all rejected material from site.
- B. If Contractor defaults or neglects to carry out the Work in accordance with Construction Documents or fails to perform any provision of Contract, Department may, after ten (10) business days' written notice to Contractor and without prejudice to any other remedy County may have, make good such deficiencies. In such case, appropriate Change Order shall be issued deducting from Contractor's payments then or thereafter, cost of correcting such deficiencies, including cost of Architect / Engineer's additional services made necessary by such default, neglect or failure.

## **22. SUBSURFACE CONDITIONS FOUND DIFFERENT**

- A. NOT USED.

## **23. RIGHT OF DEPARTMENT TO TERMINATE CONTRACT**

- A. In event that any provisions of this Contract are violated by Contractor or by any subcontractors, County may serve written notice upon Contractor and Surety of its intention to terminate Contract, such notice to contain reasons for such intention to terminate Contract, and unless within ten (10) business days after serving of such notice upon Contractor, such violation or delay shall cease and satisfactory arrangement or correction be made, Contract shall, upon expiration of said ten (10) business days, cease and terminate.
- B. In event of any such termination, County shall immediately serve notice thereof upon Surety and Contractor, and Surety shall have right to take over and perform Contract subject to County's approval; provided, however, that if Surety does not commence performance thereof within ten (10) business days from date of mailing to such Surety of notice of termination, County may take over the Work and prosecute same to completion by contract, or by force account, at expense of Contractor; Contractor and Surety shall be liable to County for any excess cost occasioned County thereby, and in such event County may take possession of and utilize in completing the Work, such materials and equipment as may be on the Work site and therefore necessary.

## **24. CONSTRUCTION SCHEDULE AND PERIODIC ESTIMATES**

- A. Contractor shall be responsible for Construction Schedule and coordination. Immediately after execution and delivery of Contract and before making first payment, Contractor shall notify all subcontractors to furnish all required information to develop Construction Schedule. Contractor and all subcontractors associated with the Work shall furnish following information from each Division of Specifications:
  - 1. List of construction activities;
  - 2. Start, finish and time required for completion of each activity;
  - 3. Sequential relationships between activities;
  - 4. Identify all long lead-time items, key events, meetings or activities such as required submittals, fabrication and delivery, procurement of materials, installation and testing;
  - 5. Weekly definition of extent of work and areas of activity for each trade or Subcontract; and
  - 6. Other information as determined by Public Works Project Manager.
- B. In addition to above requested items, Contractor shall request delivery dates for all County-furnished equipment, materials or labor. This shall include any work handled by Department under separate contracts such as asbestos abatement, air and water balancing, etc. Indicate on Construction Schedule these associated delivery and installation dates.
- C. Progress Reporting:
  - 1. Contractor shall update and publish Construction Schedule on monthly basis. Revisions to Schedule shall be by Contractor and made in same detail as original Schedule and accompanied by explanation of reasons for revision; and shall be subject to approval by Department.
  - 2. Failure of Contractor to keep Schedule in updated format shall result in County hiring firm specializing in construction schedule development and deducting those costs associated with updating process from payments due Contractor.
  - 3. Contractor shall submit show actual percentage of each activity completed, estimated future progress, and anticipated completion time.
- D. Responsibility for timely completion requires:

1. Contractor and subcontractors understand that performance of each is interdependent upon performance of others.
  2. Whenever it becomes apparent from current schedule, that phasing or progress completion dates will not be met, Contractor must take some or all following actions at no additional cost to County:
    - a) Increase construction labor in such quantities and crafts as will eliminate backlog of work.
    - b) Increase number of working hours per shift, shifts per working day, working days per week, amount of construction equipment, or any combination of foregoing to eliminate backlog of work.
    - c) Reschedule work (yet remain in conformance with Drawings and Specifications).
  3. Prior to proceeding with any of above actions, Contractor shall notify Public Works Project Manager.
- E. Maintain current Construction Schedule at all times. Revise Construction Schedule in same detail as original and accompany with explanation of reasons for revision. Schedule shall be subject to approval by Architect / Engineer and Public Works Project Manager.

## **25. PAYMENTS TO CONTRACTOR**

- A. Contractor shall provide:
1. Detailed estimate giving complete breakdown of contract price by Specification Division; and
  2. Periodic itemized estimates of work done for purpose of making partial payments thereon.
- B. Submit these estimates for approval first to Architect / Engineer, then to Public Works Project Manager. Costs employed in making up any of these schedules are for determining basis of partial payments and not considered as fixing basis for additions to or deductions from Contract price.
- C. County will make partial payments to Contractor for value, proportionate to amount of Contract, of all labor and material incorporated in the Work during preceding calendar month upon receipt of Application and Certificate for Payment form from Architect / Engineer and approval of Department.
- D. Contractor shall submit for approval first to Architect / Engineer, and then to Public Works Project Manager all Application and Certificate for Payment forms. If requested, Application and Certificate for Payment shall be supported by such additional evidence as may be required, showing Contractor's right to payment claimed.
- E. Application and Certificate for Payment for preparatory work and materials delivered and suitably stored at site to be incorporated into the Work at some future period, will be given due consideration. Requesting payment for materials stored off site, may be rejected, however, if deemed essential for reasons of job progress, protection, or other sufficient cause, requests will be considered, conditional upon submission by Contractor of bills of sale, photographs and such other procedures as will adequately protect County's interest such as storage in bonded warehouse with adequate coverage. If there is any error in payment, Contractor is obligated to notify Department immediately, but no longer than ten (10) business days from receipt of payment.
- F. Payments by County will be due within forty-five (45) business days after receipt by Department of Application and Certificate for Payment.



- G. County will retain five percent (5%) of each Application and Certificate for Payment until final completion and acceptance of all the Work covered by Contract. However, anytime after fifty percent (50%) of the Work has been furnished and installed at site, County will make remaining payments in full if Architect / Engineer and Public Works Project Manager find that progress of the Work corresponds with Construction Schedule. If Architect / Engineer and Public Works Project Manager find that progress of the Work does not correspond with Construction Schedule, County may retain up to ten percent (10%) of each Application and Certificate for Payment for the Work completed.
- H. All material and work covered by partial payments made shall become sole property of County, but this provision shall not be construed as relieving Contractor from sole responsibility for care and protection of materials and work upon which payments have been made, or restoration of any damaged work, or as waiver of right of County to require fulfillment of all of terms of Contract.
- I. County will make final payment within sixty (60) calendar days after final completion of the Work, and will constitute acceptance thereof. Submit Equal Benefits Compliance Payment Certification with final pay request. Payment may be denied if Certification is not included.
- J. County may make payment in full, including retained percentages and less authorized deductions, upon completion and acceptance of each Division where price is stated separately in Contract.
- K. Every contractor engaged in performance of any contract for Department of Public Works, Highway & Transportation shall submit to this Department, as requested and with final application for payment for work under said contract, affidavit(s) as required to prove that all debts and claims against this Work are paid in full or otherwise satisfied, and give final evidence of release of all liens against the Work and County.

## **26. WITHHOLDING OF PAYMENTS**

- A. County, after having served written notice on said Contractor, may either pay directly any unpaid bills of which Department has written notice, or withhold from Contractor's unpaid compensation sum of money deemed reasonably sufficient to pay any and all such lawful claims until satisfactory evidence is furnished that all liabilities have been fully discharged; whereupon, payment to Contractor shall be resumed in accordance with terms of this Contract, but in no event shall these provisions be construed to impose any obligations upon County to either Contractor or Contractor's Surety.
- B. In paying any unpaid bills of Contractor, County shall be deemed agent of Contractor, and any payment so made by County, shall be considered as payment made under Contract by County to Contractor and County shall not be liable to Contractor for any such payment made in good faith.
- C. Contractor shall indemnify, hold harmless and defend Dane County, its boards, commissions, agencies, officers, employees and representatives from all claims growing out of lawful demands of subcontractors, laborers, workers, mechanics, material men, and furnishers of machinery and parts thereof, equipment, power tools, and all supplies, including commissary, incurred in performance of this Contract.
- D. At Department's request, Contractor shall furnish satisfactory evidence that all obligations of nature designated above have been paid, discharged or waived.

## **27. ACCEPTANCE OF FINAL PAYMENT AS RELEASE**

- A. Making of final payment shall constitute waiver of all claims by County except those arising from:
  - 1. Unsettled lien;
  - 2. Faulty or defective work appearing after substantial completion;
  - 3. Failure of the Work to comply with requirements of Construction Documents; or
  - 4. Terms of any special guarantees required by Construction Documents.
- B. Acceptance of final payment shall constitute waiver of all claims by Contractor.

## **28. PAYMENTS BY CONTRACTOR**

- A. Contractor shall pay following not later than fifth (5<sup>th</sup>) business day following each payment received from County:
  - 1. All transportation and utility services rendered;
  - 2. All materials, tools, and other expendable equipment that have been delivered at site of the Work to extent of ninety percent (90%) of cost thereof, and balance of cost thereof when said balance is paid to Contractor; and
  - 3. Each subcontractor, respective amount allowed Contractor because of work performed by subcontractor to extent of subcontractor's interest therein.

## **29. CONTRACT SECURITY**

- A. Contractor shall furnish Performance and Payment Bonds in amount at least equal to one hundred percent (100%) of Contract price as security for faithful performance of this Contract and payment of all persons performing labor on project under this Contract and furnishing materials in connection with this Contract.
- B. Sample Performance and Payment Bonds that Contractor will be required to execute is bound into these Construction Documents. Before construction Contract is consummated, completed Performance and Payment Bonds must be approved by Department.

## **30. ASSIGNMENTS**

- A. Contractor shall not assign whole or any part of this Contract or any moneys due or to become due hereunder without written consent of Department. In case Contractor assigns all or any part of any moneys due or to become due under this Contract, instrument of assignment shall contain clause substantially to effect that it is agreed that right of assignee in and to any moneys due or to become due to Contractor shall be subject to prior claims of all persons, firms and corporations for services rendered or materials supplied for performance of the Work called for in this Contract.

## **31. MUTUAL RESPONSIBILITY OF CONTRACTORS**

- A. If, through acts of neglect on part of Contractor or any subcontractor shall suffer loss or damage on the Work, Contractor agrees to settle with such subcontractor by agreement or arbitration if such other subcontractor will so settle. If such subcontractor shall assert any claim against County on account of any damage alleged to have been sustained, Department shall notify Contractor, who shall indemnify, hold harmless and defend Dane County, its

boards, commissions, agencies, officers, employees and representatives against any such claim.

### **32. SEPARATE CONTRACTS**

- A. Department may award other contracts for the Work and all Contractors shall fully cooperate with each other and carefully adjust their work to that provided under other contracts as may be directed by Department. No Contractor shall commit or permit any act that will interfere with performance of the Work by any other Contractor.
- B. Contractor shall coordinate the Work with those of other Contractors. Cooperation will be required in arrangement for storage of materials and in detailed execution of the Work. Contractor, including subcontractors, shall keep informed of progress and detail work of others and shall notify Architect / Engineer or Department immediately of lack of progress or defective workmanship on part of others. Failure of Contractor to keep informed of the Work progressing on site and failure to give notice of lack of progress or defective workmanship by others shall be construed as acceptance by Contractor of status of the Work as being satisfactory for proper coordination with Contractor's own work.

### **33. SUBCONTRACTS**

- A. Contractor may use services of specialty subcontractors on those parts of the Work that, under normal contracting practices, are performed by specialty subcontractors.
- B. Contractor shall not award any work to any subcontractor without prior approval of Department. Qualifications of subcontractors shall be same as qualifications of Contractor. Request for subcontractor approval shall be submitted to Department fifteen (15) business days before start of subcontractor's work. If subcontractors are changed or added, Contractor shall notify Department in writing.
- C. Contractor shall be as fully responsible to County for acts and omissions of subcontractors, and of persons either directly or indirectly employed by them, as Contractor is for acts and omissions of persons directly employed by Contractor.
- D. Contractor shall cause appropriate provisions to be inserted in all subcontracts relative to the Work to bind subcontractors to Contractor by terms of General Conditions of Contract and other Construction Documents insofar as applicable to work of subcontractors and to give Contractor same power as regards terminating any subcontract that Department may exercise over Contractor under any provision of Construction Documents.
- E. Nothing contained in this Contract shall create any contractual relation between any subcontractor and County.
- F. Contractor shall insert in all subcontracts, Articles 26, 33, 43 and 45, respectively entitled: "Withholding of Payments", "Subcontracts", "Affirmative Action Provision and Minority / Women / Disadvantaged Business Enterprises", and "Minimum Wages", and shall further require all subcontractors to incorporate physically these same Articles in all subcontracts.

### **34. PUBLIC WORKS PROJECT MANAGER'S AUTHORITY**

- A. Public Works Project Manager shall:
  - 1. Administer and ensure compliance with Construction Documents;

2. Provide responsible on-site observations of construction and have authority to request work and to stop work whenever necessary to insure proper enforcement of Construction Documents;
3. Convene and chair project meetings and foreman's coordination meetings when necessary to coordinate resolution of conflicts between Contractors, Architects, Engineers, Consultants, and Department; and
4. Check and inspect material, equipment and installation procedures of all trades for proper workmanship and for compliance with Drawings, Specifications and Shop Drawings, permit no material on project site that is not satisfactory and reject work not in compliance with Construction Documents.

### **35. ARCHITECT / ENGINEER'S AUTHORITY**

- A. Architect / Engineer is retained by, and is responsible to Department acting for County.
- B. Architect / Engineer shall determine amount, quality, acceptability, and fitness of several kinds of work and materials that are provided under this Contract and shall decide all questions that may arise in relation to said work and construction thereof.
- C. Architect / Engineer shall decide meaning and intent of any portion of Specifications and of any Drawings where they may be found obscure or be in dispute.
- D. Architect / Engineer shall provide responsible observation of construction. Architect / Engineer has authority to stop the Work whenever such stoppage may be necessary to insure proper execution of Construction Documents.
- E. Architect / Engineer shall be interpreter of conditions of Construction Documents and judge of its performance.
- F. Within reasonable time, Architect / Engineer shall make decisions on all matters relating to progress of the Work or interpretation of Construction Documents.
- G. Architect / Engineer's decisions are subject to review by Public Works Project Manager.

### **36. STATED ALLOWANCES**

- A. Stated allowances enumerated in Instructions to Bidders shall cover net cost of materials or equipment, and all applicable taxes. Contractor's cost of delivery and unloading at site, handling costs on site, labor, installation costs, overhead, profit and any other incidental costs shall be included in Contractor's bid, but not as part of cash allowance.
- B. Department will solicit at least two (2) bids on materials or equipment for which allowance is stated and select on basis of lowest qualified responsible bid. Contractor will then be instructed to purchase "Allowed Materials". If actual price for purchasing "Allowed Materials", including taxes, is more or less than "Cash Allowance", Contract price shall be adjusted accordingly. Adjustment in Contract price shall not contain any cost items excluded from cash allowance.

### **37. ESTIMATES OF QUANTITIES**

- A. Whenever estimated quantities of work to be done and materials to be furnished under this Contract are shown in any of Construction Documents, they are given for use in comparing

bids and right is especially reserved to increase or diminish them as they may be deemed reasonably necessary or desirable by Department to complete the Work included in this Contract, and cost for such increase or diminution shall be adjusted in manner provided for in General Conditions of Contract Article 18 entitled "Changes in the Work".

**38. LANDS AND RIGHTS-OF-WAY**

- A. Prior to start of construction, County shall furnish all land and rights-of-way necessary for carrying out and completion of the Work to be performed under this Contract.

### **39. GENERAL GUARANTEE**

- A. Neither final certificate of payment nor any provision in Construction Documents nor partial or entire occupancy of premises by County shall constitute acceptance of work not done in accordance with Construction Documents or relieve Contractor of liability in respect to any expressed warranties or responsibility for faulty materials or workmanship.
  - 1. In no event shall making of any payment required by Contract constitute or be construed as waiver by County of any breach of covenants of Contract or waiver of any default of Contractor and making of any such payment by County while any such default or breach shall exist shall in no way impair or prejudice right of County with respect to recovery of damages or other remedy as result of such breach or default.
- B. Contractor shall remedy and make good all defective workmanship and materials and pay for any damage to other work resulting there from, which appear within period of one (1) year from date of substantial completion, providing such defects are not clearly due to abuse or misuse by County. Department will give notice of observed defects with reasonable promptness.
- C. Guarantee on work executed after certified date of substantial completion will begin on date when such work is inspected and approved by Architect / Engineer and Public Works Project Manager.
- D. Where guarantees or warranties are required in sections of Specifications for periods in excess of one (1) year, such longer terms shall apply; however, Contractor's Performance and Payment Bonds shall not apply to any guarantee or warranty period in excess of one (1) year.

### **40. CONFLICTING CONDITIONS**

- A. Any provision in any of Construction Documents which may be in conflict or inconsistent with any Articles in these General Conditions of Contract or Supplementary Conditions shall be void to extent of such conflict or inconsistency.
- B. In case of ambiguity or conflict between Drawings and Specifications, Specifications shall govern.
- C. Printed dimensions shall be followed in preference to measurements by scale. Large-scale drawings take precedence over small-scale drawings. Dimensions on Drawings and details are subject to field measurements of adjacent work.

### **41. NOTICE AND SERVICE THEREOF**

- A. Any notice to Contractor from Department relative to any part of this Contract shall be in writing and considered delivered and service thereof completed, when said notice is posted, by certified or registered mail, to Contractor at Contractor's last given address, or delivered in person to said Contractor, or Contractor's authorized representative on the Work.

## **42. PROTECTION OF LIVES AND HEALTH**

- A. In order to protect lives and health of Contractor's employees under Contract, Contractor shall comply with all pertinent provisions of Wisconsin Administrative Code, Rules of Department of Commerce, relating to Safety and Health.
- B. Contractor alone shall be responsible for safety, efficiency and adequacy of Contractor's tools, equipment and methods, and for any damage that may result from their failure or their improper construction, maintenance or operation.

## **43. AFFIRMATIVE ACTION PROVISION AND MINORITY / WOMEN / DISADVANTAGED BUSINESS ENTERPRISES**

- A. Affirmative Action Provisions.
  - 1. During term of their Contract, Contractor agrees not to discriminate on basis of race, religion, color, sex, handicap, age, sexual preference, marital status, physical appearance, or national origin against any person, whether recipient of services (actual or potential), employee, or applicant for employment. Such equal opportunity shall include but not be limited to following: employment, upgrading, demotion, transfer, recruitment, advertising, layoff, termination, training, rates of pay, and any other form of compensation or level of service(s). Contractor agrees to post in conspicuous places, these affirmative action standards so as to be visible to all employees, service recipients and applicants for this paragraph. Listing of prohibited bases for discrimination shall not be construed to amend in any fashion state or federal law setting forth additional bases and exceptions shall be permitted only to extent allowable in state or federal law.
  - 2. Contractor is subject to this Article only if Contractor has ten (10) or more employees and receives \$10,000.00 or more in annual aggregate contracts with County. Contractor shall file and Affirmative Action Plan with Dane County Contract Compliance Officer in accord with Chapter 19 of Dane County Code of Ordinances. Such plan must be filed within fifteen (15) business days of effective date of this Contract and failure to do so by said date shall constitute ground for immediate termination of Contract by County. Contractor shall also, during term of this Contract, provide copies of all announcements of employment opportunities to County's Contract Compliance Office, and shall report annually number of persons, by race, sex and handicap status, who apply for employment, and, similarly classified, number hired and number rejected.
  - 3. Contact Dane County Contract Compliance Officer at Dane County Contract Compliance Office, 210 Martin Luther King, Jr. Blvd., Room 421, Madison, WI 53703, 608/266-4114.
  - 4. In all solicitations for employment placed on Contractor's behalf during term of this Contract, Contractor shall include statement to affect Contractor is "Equal Opportunity Employer". Contractor agrees to furnish all information and reports required by County's Contract Compliance Officer as same relate to affirmative action and nondiscrimination, which may include any books, records, or accounts deemed appropriate to determine compliance with Chapter 19, Dane County Code of Ordinances, and provision of this Contract.
- B. Minority / Women / Disadvantaged / Emerging Small Business Enterprises.
  - 1. Chapter 19.508 of Dane County Code of Ordinances is official policy of Dane County regarding utilization of, to fullest extent of, Minority Business Enterprises (MBEs), Women Business Enterprises (WBEs) Disadvantage Business Enterprises (DBEs) and Emerging Small Business Enterprises (ESBEs).
  - 2. Contractor may utilize MBEs / WBEs / DBEs / ESBEs as subcontractors or suppliers. List of subcontractors will be required of low bidder as stated in this Contract. List shall

indicate which are MBEs / WBEs / DBEs / ESBEs and percentage of subcontract awarded, shown as percentage of total dollar amount of bid.

#### **44. COMPLIANCE WITH FAIR LABOR STANDARDS**

- A. During term of this Contract, Contractor shall report to County Contract Compliance Officer, within ten (10) business days, any allegations to, or findings by National Labor Relations Board (NLRB) or Wisconsin Employment Relations Commission (WERC) that Contractor has violated statute or regulation regarding labor standards or relations. If investigation by Contract Compliance Officer results in final determination that matter adversely affects Contractor's responsibilities under this Contract, and which recommends termination, suspension or cancellation of this Contract, County may take such action.
- B. Contractor may appeal any adverse finding by Contract Compliance Officer as set forth in Dane County Ordinance 25.015(11)(c) through (e).
- C. Contractor shall post this statement in prominent place visible to employees: "As condition of receiving and maintaining contract with Dane County, this employer shall comply with federal, state and all other applicable laws prohibiting retaliation or union organizing."

#### **45. DOMESTIC PARTNERSHIP BENEFITS**

- A. Not Used.

#### **46. USE AND OCCUPANCY PRIOR TO ACCEPTANCE**

- A. Contractor agrees to use and occupancy of portion or unit of the Work before formal acceptance by Department, provided Department:
  - 1. Secures written consent of Contractor; except when in opinion of Public Works Project Manager, Contractor is chargeable with unwarranted delay in final cleanup of punch list items or other Contract requirements.
  - 2. Secures endorsement from insurance carrier and consent of Surety permitting occupancy of building or use of the Work during remaining period of construction, or, secures consent of Surety.
  - 3. Assumes all costs and maintenance of heat, electricity and water.
  - 4. Accepts all work completed within that portion or unit of the Work to be occupied, at time of occupancy.

#### **47. MINIMUM WAGES**

- A. Not Used.

#### **48. CLAIMS**

- A. No claim may be made until Department's Assistant Public Works Director has reviewed Architect / Engineer's decision as provided for in Article 35 of General Conditions of Contract. If any claim remains unresolved after such review by Department's Assistant Public Works Director the claim may be filed under Wisconsin Statute 893.80. Work shall progress during period of any dispute or claim. Unless specifically agreed between parties, venue will be in Dane County, Wisconsin.



## **49. ANTITRUST AGREEMENT**

- A. Contractor and County recognize that in actual economic practice, overcharges resulting from antitrust violations are in fact usually borne by County. Therefore, Contractor hereby assigns to County any and all claims for such overcharges as to goods and materials purchased in connection with this Contract, except as to overcharges which result from antitrust violations commencing after price is established under this Contract and any change order thereto.

## **50. INSURANCE**

A. Contractor Carried Insurance:

1. Contractor shall not commence work under this Contract until Contractor has obtained all insurance required under this Article and has provided evidence of such insurance to Risk Manager, 425 City-County Building, 210 Martin Luther King Jr. Blvd., Madison, WI 53703. Contractor shall not allow any subcontractor to commence work until insurance required of subcontractor has been so obtained and approved. Company providing insurance must be licensed to do business in Wisconsin.
2. Worker's Compensation Insurance:
  - a) Contractor shall procure and shall maintain during life of this Contract, Worker's Compensation Insurance as required by statute for all of Contractor's employees engaged in work at site of project under this Contract and, in case of any such work sublet, Contractor shall require subcontractor similarly to provide Worker's Compensation Insurance for all of latter's employees to be engaged in such work unless such employees are covered by protection afforded by Contractor's Worker's Compensation Insurance.
  - b) If any claim of employees engaged in hazardous work on project under this Contract is not protected under Worker's Compensation Statute, Contractor shall provide and shall cause each subcontractor to provide adequate Employer's Liability Insurance for protection of such of Contractor's employees as are not otherwise protected.
3. Contractor's Public Liability and Property Damage Insurance:
  - a) Contractor shall procure and maintain during life of this Contract, Contractor's Public Liability Insurance and Contractor's Property Damage Insurance in amount not less than \$1,000,000 bodily injury, including accidental death, to any one person, and subject to same limit for each person, in amount not less than \$1,000,000 on account of one accident, and Contractor's Property Damage Insurance in amount not less than \$1,000,000 or combined single limit of at least \$1,000,000 with excess coverage over and above general liability in amount not less than \$5,000,000. Contractor shall add "Dane County" as additional insured for each project.
  - b) Contractor's Public Liability and Property Damage Insurance shall include Products, Completed Operation, and Contractual Liability under Insurance Contract. "Contractor shall in all instances save, defend, indemnify and hold harmless County and Architect / Engineer against all claims, demands, liabilities, damages or any other costs which may accrue in prosecution of the Work and that Contractor will save, defend, indemnify and hold harmless County and Architect / Engineer from all damages caused by or as result of Contractor's operations" and each shall be listed as additional insured on Contractor's and sub-contractors' insurance policies.
  - c) Obligations of Contractor under Article 50.A.2.b) shall not extend to liability of Architect / Engineer, agents or employees thereof, arising out of:
    - 1) Preparation or approval of maps, drawings, opinions, reports, surveys, change orders, designs or specifications; or
    - 2) Giving of or failure to give directions or instructions by Architect / Engineer, agents or employees thereof provided such giving or failure to give is primary cause of injury or damage.

- d) Contractor shall procure and shall maintain during life of this Contract, Comprehensive Automobile Liability Insurance covering owned, non-owned and hired automobiles for limits of not less than \$1,000,000 each accident single limit, bodily injury and property damage combined with excess coverage over and above general liability in amount not less than \$5,000,000.
- e) Contractor shall either:
  - 1) Require each subcontractor to procure and to maintain during life of subcontract, subcontractor's Public Liability Property Damage Insurance, and Comprehensive Automobile Liability Insurance of type and in same amount specified in preceding paragraphs; or
  - 2) Insure activities of subcontractors in Contractor's own policy.
- 4. Scope of Insurance and Special Hazards: Insurance required under Article 50.A.2 & 50.A.3. hereof shall provide adequate protection for Contractor and subcontractors, respectively, against damage claims which may arise from operations under this Contract, whether such operation be by insured or by anyone directly or indirectly employed by insured and also against any of special hazards which may be encountered in performance of this Contract as enumerated in Supplementary Conditions.
- 5. Proof of Carriage of Insurance: Contractor shall furnish Risk Manager with certificates showing type, amount, class of operations covered, effective dates, dates of expiration of policies and "Dane County" listed as additional insured. Such certificates shall also contain (substantially) following statement: "Insurance covered by this certificate will not be canceled or materially altered, except after ten (10) business days written notice has been received by Risk Manager."

**B. Builder's Risk:**

- 1. County shall provide Builder's Risk insurance coverage for its insurable interests in construction or renovation projects with completed value of \$1,000,000 or less. Therefore, if project completed value is more than \$1,000,000, Contractor shall obtain and maintain in force, at its own expense, Builder's Risk Insurance on all risks for amount equal to full completed value of covered structure or replacement value of alterations or additions. Any deductible shall not exceed \$25,000 for each loss. Policy shall include occupancy clause and list Dane County as loss payee.

**C. Indemnification / Hold Harmless:**

- 1. Contractor shall indemnify, hold harmless and defend Dane County, its boards, commissions, agencies, officers, employees and representatives from and against all claims, damages, losses and expenses including attorneys' fees arising out of or resulting from performance of the Work, provided that any such claim, damage, loss or expense is attributable to bodily injury, sickness, disease or death, or to injury to or destruction of tangible property (other than the Work itself) including loss of use resulting therefrom, and is caused in whole or in part by any act or omission of Contractor, any subcontractor, anyone directly or indirectly employed by any of them or anyone for whose acts any of them may be liable, regardless of whether or not it is caused in part by part indemnified hereunder.
- 2. In any and all claims against Dane County, its boards, commissions, agencies, officers, employees and representatives or by any employee of Contractor, any subcontractor, anyone directly or indirectly employed by any of them or anyone for whose acts any of them may be liable, indemnification obligation under this Contract shall not be limited in any way by any limitation on amount or type of damages, compensation or benefits payable by or for Contractor or any subcontractor under worker's compensation acts, disability benefits or other employee benefit acts.
- 3. Obligations of Contractor under this Contract shall not extend to liability of Architect / Engineer, its agents or employees arising out of:

- a) Preparation or approval of maps, drawings, opinion, reports, surveys, change orders, designs or specifications; or
  - b) Giving of or failure to give directions or instruction by Architect / Engineer, its agents or employees provided such giving or failure to give is primary cause of injury or damage.
4. Dane County shall not be liable to Contractor for damages or delays resulting from work by third parties or by injunctions or other restraining orders obtained by third parties.

**51. WISCONSIN LAW CONTROLLING**

- A. It is expressly understood and agreed to by parties hereto that in event of any disagreement or controversy between parties, Wisconsin law shall be controlling.

# SUPPLEMENTARY CONDITIONS

## 1. APPLICATION & CERTIFICATE FOR PAYMENT

- A. Every contractor engaged in performance of any contract for Department of Public Works, Highway & Transportation shall submit partial and final Application & Certificate for Payment for work under said contract. Form shall provide similar information as shown on AIA G702™ and G703™ forms (samples shown below). Forms shall be submitted to [project Architect / Engineer, Public Works Project Manager] for approval.

**AIA** Document G702™ – 1992

**Application and Certificate for Payment**

TO OWNER:	PROJECT:	APPLICATION NO:	Distribution to:
FROM CONTRACTOR:	VIA ARCHITECT:	PERIOD TO:	OWNER <input type="checkbox"/>
		CONTRACT FOR:	ARCHITECT <input type="checkbox"/>
		CONTRACT DATE:	CONTRACTOR <input type="checkbox"/>
		PROJECT NOS:	FIELD <input type="checkbox"/>
			OTHER <input type="checkbox"/>

---

**CONTRACTOR'S APPLICATION FOR PAYMENT**

Application is made for payment, as shown below, in connection with the Contract. AIA Document G703™, Continuation Sheet, is attached.

1. ORIGINAL CONTRACT SUM ..... \$ \_\_\_\_\_

2. NET CHANGE BY CHANGE ORDERS ..... \$ \_\_\_\_\_

3. CONTRACT SUM TO DATE (Line 1 + 2) ..... \$ \_\_\_\_\_

4. TOTAL COMPLETED & STORED TO DATE (Column G on G703) ..... \$ \_\_\_\_\_

5. RETAINAGE:

a. \_\_\_\_\_ % of Completed Work  
(Columns D + E on G703) ..... \$ \_\_\_\_\_

b. \_\_\_\_\_ % of Stored Material  
(Column F on G703) ..... \$ \_\_\_\_\_

Total Retainage (Lines 5a + 5b, or Total in Column I of G703) ..... \$ \_\_\_\_\_

6. TOTAL EARNED LESS RETAINAGE ..... \$ \_\_\_\_\_  
(Line 4 minus Line 5 Total)

7. LESS PREVIOUS CERTIFICATES FOR PAYMENT ..... \$ \_\_\_\_\_  
(Line 6 from prior Certificate)

8. CURRENT PAYMENT DUE ..... \$ \_\_\_\_\_

9. BALANCE TO FINISH, INCLUDING RETAINAGE ..... \$ \_\_\_\_\_  
(Line 3 minus Line 6)

The undersigned Contractor certifies that to the best of the Contractor's knowledge, information and belief the Work covered by this Application for Payment has been completed in accordance with the Contract Documents, that all amounts have been paid by the Contractor for Work for which previous Certificates for Payment were issued and payments received from the Owner, and that current payment shown herein is now due.

CONTRACTOR:  
By: \_\_\_\_\_ Date: \_\_\_\_\_  
State of: \_\_\_\_\_  
County of: \_\_\_\_\_  
Subscribed and sworn to before me this \_\_\_\_\_ day of \_\_\_\_\_

Notary Public:  
My commission expires: \_\_\_\_\_

---

CHANGE ORDER SUMMARY	ADDITIONS	DEDUCTIONS
Total changes approved in previous months by Owner	\$	\$
Total approved this month	\$	\$
<b>TOTAL</b>	<b>\$</b>	<b>\$</b>
NET CHANGES by Change Order	\$	\$

**ARCHITECT'S CERTIFICATE FOR PAYMENT**

In accordance with the Contract Documents, based on on-site observations and the data comprising this application, the Architect certifies to the Owner that to the best of the Architect's knowledge, information and belief the Work has progressed as indicated, the quality of the Work is in accordance with the Contract Documents, and the Contractor is entitled to payment of the AMOUNT CERTIFIED.

AMOUNT CERTIFIED ..... \$ \_\_\_\_\_  
(Attach explanation if amount certified differs from the amount applied. Initial all figures on this Application and on the Continuation Sheet that are changed to conform with the amount certified.)

ARCHITECT:  
By: \_\_\_\_\_ Date: \_\_\_\_\_

This Certificate is not negotiable. The AMOUNT CERTIFIED is payable only to the Contractor named herein. Issuance, payment and acceptance of payment are without prejudice to any rights of the Owner or Contractor under this Contract.

**CAUTION:** You should sign an original AIA Contract Document, on which this text appears in RED. An original assures that changes will not be obscured.  
 AIA Document G702™ – 1992, Copyright © 1963, 1963, 1965, 1971, 1978, 1983 and 1992 by The American Institute of Architects. All rights reserved. WARNING: This AIA® Document is protected by U.S. Copyright Law and International Treaties. Unauthorized reproduction or distribution of this AIA® Document, or any portion of it, may result in severe civil and criminal penalties, and will be prosecuted to the maximum extent possible under the law. Purchasers are permitted to reproduce ten (10) copies of this document when completed. To report copyright violations of AIA Contract Documents, e-mail The American Institute of Architects' legal counsel, copyright@aia.org.

# AIA<sup>®</sup> Document G703™ – 1992

## Continuation Sheet

AIA Document G702™-1992, Application and Certificate for Payment, or G732™-2009, Application and Certificate for Payment, Construction Manager as Adviser Edition, containing Contractor's signed certification is attached.  
 In tabulations below, amounts are in US dollars.  
 Use Column I on Contracts where variable retainage for line items may apply.

APPLICATION NO:  
 APPLICATION DATE:  
 PERIOD TO:  
 ARCHITECT'S PROJECT NO:

A ITEM NO.	B DESCRIPTION OF WORK	C SCHEDULED VALUE	D WORK COMPLETED		F MATERIALS PRESENTLY STORED <i>(Not in D or E)</i>	G TOTAL COMPLETED AND STORED TO DATE <i>(D+E-F)</i>	H BALANCE TO FINISH <i>(C-G)</i>	I RETAINAGE <i>(if variable rate)</i>
			FROM PREVIOUS APPLICATION <i>(D-E)</i>	THIS PERIOD				
<div style="font-size: 48px; opacity: 0.2; transform: rotate(-30deg); pointer-events: none;">Sample</div>								
GRAND TOTAL								

**CAUTION:** You should sign an original AIA Contract Document, on which this text appears in RED. An original assures that changes will not be obscured.

AIA Document G703™ – 1992. Copyright © 1963, 1965, 1966, 1967, 1970, 1978, 1983 and 1992 by The American Institute of Architects. All rights reserved. **WARNING:** This AIA® Document is protected by U.S. Copyright Law and International Treaties. Unauthorized reproduction or distribution of this AIA® Document, or any portion of it, may result in severe civil and criminal penalties, and will be prosecuted to the maximum extent possible under the law. Purchasers are permitted to reproduce ten (10) copies of this document when completed. To report copyright violations of AIA Contract Documents, e-mail The American Institute of Architects' legal counsel, [copyright@aia.org](mailto:copyright@aia.org). 10-1204504

SECTION 01 00 00  
BASIC REQUIREMENTS

PART 1 GENERAL

1.1 SECTION SUMMARY

- A. Section Includes:
1. Section Summary
  2. Summary of the Work
  3. Contractor Use of Premises
  4. Applications for Payment
  5. Change Procedures
  6. Alternates
  7. Coordination
  8. Cutting and Patching
  9. Conferences
  10. Progress Meetings
  11. Submittal Procedures
  12. Proposed Products List
  13. Shop Drawings
  14. Product Data
  15. Samples
  16. Manufacturers' Instructions
  17. Manufacturers' Certificates
  18. Quality Assurance / Quality Control of Installation
  19. References
  20. Interior Enclosures
  21. Protection of Installed Work
  22. Parking
  23. Staging Areas
  24. Occupancy During Construction and Conduct of Work
  25. Protection
  26. Progress Cleaning
  27. Products
  28. Transportation, Handling, Storage and Protection
  29. Product Options
  30. Substitutions
  31. Starting Systems
  32. Demonstration and Instructions
  33. Contract Closeout Procedures
  34. Final Cleaning
  35. Adjusting
  36. Operation and Maintenance Data
  37. Spare Parts and Maintenance Materials
  38. As-Built and Record Drawings and Specifications

## 1.2 SUMMARY OF THE WORK

- A. Project Description: Perform the Work as specified and detailed in Construction Documents package. Contractor to provide roof replacement on the specified portions of the roof area.
- B.
- C. Permits: Prior to commencement of the Work, Contractor to secure any and all necessary permits for completion of the Work and facility occupancy.

## 1.3 CONTRACTOR USE OF PREMISES

- A. Limit use of premises to allow work by Contractors or Subcontractors and access by Owner.
- B. Coordinate utility outages and shutdowns with Owner.

## 1.4 APPLICATIONS FOR PAYMENT

- A. Submit one (1) original copies with “wet” signatures of each application on AIA G702™ and G703™ forms or approved contractors invoice form.
- B. Content and Format: Utilize Schedule of Values for listing items in Application for Payment.
- C. Payment Period: Monthly.
- D. Submit Applications for Payment to Public Works Project Manager for approval & processing for payment.

## 1.5 CHANGE PROCEDURES

- A. Contractor's costs for Products, delivery, installation, labor, insurance, payroll, taxes, bonding, equipment rental, overhead and profit will be included in Change Orders authorizing expenditure of funds from contingency allowance.

## 1.6 ALTERNATES

- A. Alternates quoted on Bid Form shall be reviewed and accepted or rejected at Owner's option.
- B. Coordinate related work and modify surrounding work as required.
- C. Schedule of Alternates: there are no alternates proposed for this project.

## 1.7 COORDINATION

- A. Coordinate scheduling, submittals, and work of various sections of Specifications to assure efficient and orderly sequence of installation of interdependent construction elements.
- B. Verify utility requirement characteristics of operating equipment are compatible with building utilities.
- C. Coordinate space requirements and installation of mechanical and electrical work that are indicated diagrammatically on Drawings.
- D. Contractor shall provide Public Works Project Engineer with work plan that ensures the Work will be completed within required time of completion.
- E. Public Works Project Manager may choose to photograph or videotape site or workers as the Work progresses.

## 1.8 CUTTING AND PATCHING

- A. Employ skilled and experienced installer to perform cutting and patching new work; restore work with new Products.
- B. Submit written request in advance of cutting or altering structural or building enclosure elements.
- C. Fit work tight to adjacent elements. Maintain integrity of wall, ceiling, or floor construction; completely seal voids.
- D. Refinish surfaces to match adjacent finishes.

## 1.9 CONFERENCES

- A. Project shall have pre-bid conference; see Instructions to Bidders.
- B. Owner will schedule preconstruction conference after Award of Contract for all affected parties.
- C. Contractor shall submit Construction Schedule at pre-construction meeting.
- D. When required in individual Specification section, convene pre-installation conference at project site prior to commencing work of Section.

## 1.10 PROGRESS MEETINGS

- A. Schedule and administer meetings throughout progress of the Work at minimum of one (1) per week, with Public Works Project Manager.



- B. Preside at meetings, record minutes, and distribute copies within two (2) business days to those affected by decisions made.
- C. Attendance at progress meetings by General Contractor, subcontractors, or their authorized representative, is mandatory.
- D. Contractors shall give verbal reports of progress on the Work, discuss schedule for upcoming period and present all conflicts, discrepancies or other difficulties for resolution.
- E. Day & time of progress meetings to be determined at pre-construction meeting.

#### 1.11 SUBMITTAL PROCEDURES

- A. Submittal form to identify Project, Contractor, Subcontractor or supplier; and pertinent Construction Documents references.
- B. Apply Contractor's stamp, signed or initialed, certifying that review, verification of Products required, field dimensions, adjacent construction work, and coordination of information is in accordance with requirements of the Work and Construction Documents.
- C. Identify variations from Construction Documents and Product or system limitations that may be detrimental to successful performance of completing the Work.
- D. Revise and resubmit submittals as required; identify all changes made since previous submittal.

#### 1.12 PROPOSED PRODUCTS LIST

- A. Within fifteen (15) business days after date of Award of Contract, submit complete list of major Products proposed for use, with name of manufacturer, trade name, and model number of each Product.

#### 1.13 SHOP DRAWINGS

- A. Submit number of copies that Contractor requires, plus three (3) copies that shall be retained by Public Works Project Manager.

#### 1.14 PRODUCT DATA

- A. Submit number of copies that Contractor requires, plus two (2) copies that shall be retained by Public Works Project Manager.
- B. Mark each copy to identify applicable products, models, options, and other data. Supplement manufacturer's standard data to provide information unique to this Project.

1.15 SAMPLES

- A. Submit samples to illustrate functional and aesthetic characteristics of Product.
- B. Submit samples of finishes from full range of manufacturers' standard colors, textures, and patterns for Public Works Project Manager's selection.

1.16 MANUFACTURERS' INSTRUCTIONS

- A. When specified in individual Specification sections, submit manufacturers' printed instructions for delivery, storage, assembly, installation, start-up, adjusting, and finishing, in quantities specified for Product Data.

1.17 MANUFACTURERS' CERTIFICATES

- A. When specified in individual Specification sections, submit manufacturers' certificate to Public Works Project Manager for review, in quantities specified for Product Data.
- B. Indicate material or Product conforms to or exceeds specified requirements. Submit supporting reference data, affidavits, and certifications as appropriate.

1.18 QUALITY ASSURANCE / QUALITY CONTROL OF INSTALLATION

- A. Monitor quality control over suppliers, manufacturers, Products, services, site conditions, and workmanship, to produce work of specified quality.
- B. Comply fully with manufacturers' instructions.
- C. Comply with specified standards as minimum quality for the Work except when more stringent tolerances, codes, or specified requirements indicate higher standards or more precise workmanship.

1.19 REFERENCES

- A. Conform to reference standard by date of issue current as of date for receiving bids.
- B. Should specified reference standard conflict with Construction Documents, request clarification from Public Works Project Manager before proceeding.

1.20 INTERIOR ENCLOSURES

- A. NOT USED.

1.21 PROTECTION OF INSTALLED WORK

- A. Protect installed work and provide special protection where specified in individual Specification sections.

## 1.22 PARKING

- A. Arrange for temporary parking areas to accommodate construction personnel.
- B. Do not obstruct existing service drives and parking lots with equipment, materials and / or vehicles. Keep accessible for Owner's use at all times.

## 1.23 STAGING AREAS

- A. Coordinate staging areas with Public Works Project Manager prior to starting the Work.
- B. On-site space for use as staging areas and storage of materials is limited and will be apportioned among various Contractors as their needs dictate with due regard for storage requirements of each Contractor. Each Contractor shall be responsible for safety of equipment and materials that are stored on site.

## 1.24 OCCUPANCY DURING CONSTRUCTION AND CONDUCT OF WORK

- A. Smoking is prohibited on Dane County property.
- B. Owner reserves right at any time to dismiss from premises any Contractor or construction personnel that do not uphold requirements of this Section.
- C. Owner shall not be held liable for any lost time, wages, or impacts to construction schedule by any Contractor or construction personnel dismissed for failure to uphold requirements of this Section.
- D. Work shall be done and temporary facilities furnished so as not to interfere with access to any occupied area and so as to cause least possible interference with normal operation of facility or any essential service thereof.
- E. Contractor shall, at all times, provide approved, safe walkways and facility entrances for use by Owner, employees and public.
- F. Contractor shall provide adequate protection for all parts of facility, its contents and occupants wherever the Work under this Contract is to be performed.
- G. Each Contractor shall arrange with Owner to make necessary alterations, do new work, make connections to all utilities, etc., at such times as will not cause interruption of utility services to facility. Contractor doing this work shall protect, cap, cut off and / or replace and relocate existing pipes, electrical work and other active utilities encountered which may interfere with new construction work.
- H. New work in extension of existing work shall correspond in all respects with that to which it connects or similar existing work unless otherwise indicated or specified.
  - 1. Existing work shall be cut, altered, removed or replaced as necessary for performance of Contract obligations.
  - 2. Work remaining in place, damaged or defaced by reason of work done under this Contract shall be restored equal to its condition at time of Award of Contract.

3. If removal of work exposes discolored or unfinished surfaces or work out of alignment, such surfaces shall be refinished or materials replaced as necessary to make continuous work uniform and harmonious.

I. Contractor is not responsible for providing & maintaining temporary toilet facilities.

#### 1.25 PROTECTION

- A. Contractor shall protect from damage / injury all mechanical, electrical & plumbing equipment, walks and driveways and pay for any damage to same resulting from insufficient or improper protection.
- B. Contractor shall provide and maintain barricades & signage to prohibit public access to construction site.

#### 1.26 PROGRESS CLEANING

- A. Maintain areas free of waste materials, debris, and rubbish. Maintain site in clean and orderly condition.

#### 1.27 PRODUCTS

- A. Products: Means new material, machinery, components, equipment, fixtures, and systems forming the Work, but does not include machinery and equipment used for preparation, fabrication, conveying and erection of the Work. Products may also include existing materials or components specifically identified for reuse.
- B. Do not use materials and equipment removed from existing premises, except as specifically identified or allowed by Construction Documents.

#### 1.28 TRANSPORTATION, HANDLING, STORAGE AND PROTECTION

- A. Transport, handle, store and protect Products in accordance with manufacturer's instructions.

#### 1.29 PRODUCT OPTIONS

- A. Where definite material is specified, it is not intentional to discriminate against "equal" product made by another manufacturer. Intention is to set definite standard of material quality. Should bidder choose to bid materials other than those specified, bidder shall submit said materials specifications to Public Works Project Manager for approval at least seven (7) business days prior to Bid Due Date.
- B. Products and materials that are not specified, but have been approved for use by Public Works Project Manager shall be identified in addenda to all bidding contractors.
- C. Requests for material or product substitutions submitted after Bid Due Date may be considered. Owner reserves right to approve or reject substitutions based on Specification requirements and intended use.

### 1.30 SUBSTITUTIONS

- A. Public Works Project Manager shall consider requests for Substitutions only within fifteen (15) calendar days after date of Public Works Construction Contract.
- B. Document each request with complete data substantiating compliance of proposed Substitution with Construction Documents.
- C. Submit three (3) copies of requests for Substitution for consideration. Limit each request to one (1) proposed Substitution.
- D. Substitutions shall not change contract price established at Bid Due Date.

### 1.31 STARTING SYSTEMS

- A. Not Used.

### 1.32 DEMONSTRATION AND INSTRUCTIONS

- A. Demonstrate operation and maintenance of Products to Owner's personnel prior to date of final inspection.
- B. Owner may choose to photograph or videotape demonstration session; demonstration and demonstrator shall be to level of satisfaction of Owner.

### 1.33 CONTRACT CLOSEOUT PROCEDURES

- A. Submit written certification that Construction Documents have been reviewed, the Work has been inspected, and the Work is complete in accordance with Construction Documents and ready for Public Works Project Manager's inspection.
- B. Submit final Application for Payment identifying total adjusted Contract Sum / Price, previous payments, and amount remaining due.

### 1.34 FINAL CLEANING

- A. Execute final cleaning prior to final inspection.
- B. Clean interior and exterior surfaces exposed to view.
- C. Remove waste and surplus materials, rubbish, and construction facilities from site.

### 1.35 ADJUSTING

- A. Adjust operating Products and equipment to ensure smooth and unhindered operation.

1.36 OPERATION AND MAINTENANCE MANUAL

- A. Provide two (2) bound, hard-copy operation and maintenance manuals that include all systems, materials, products, equipment, mechanical and electrical equipment and systems supplied and installed in the Work. Provide electronic version of operation and maintenance manual also.

1.37 SPARE PARTS AND MAINTENANCE MATERIALS

- A. Provide Products, spare parts, maintenance and extra materials in quantities specified in individual Specification Sections.
- B. Deliver to the Work site and place in location as directed.

1.38 AS-BUILT AND RECORD DRAWINGS AND SPECIFICATIONS

- A. Contractor-produced Drawings and Specifications shall remain property of Contractor whether Project for which they are made is executed or not. Contractor shall furnish Public Works Project Manager with original marked up redlines of Construction Documents' drawings and specifications that shall include all Addendums, Change Orders, Construction Bulletins, on-site changes, field corrections, etc. These are project As-Built Drawings & Specifications. Record Drawings & Specifications shall be created from these As-Built by Public Works.

PART 2 PRODUCTS

Not Used.

PART 3 EXECUTION

Not Used.

END OF SECTION

## SECTION 01 74 19

### CONSTRUCTION WASTE MANAGEMENT, DISPOSAL & RECYCLING

#### PART 1 GENERAL

##### 1.1 SUMMARY

- A. Section Includes:
  - 1. Summary
  - 2. Waste Management Goals
  - 3. Construction and / or Demolition Waste Management
  - 4. Waste Management Plan
  - 5. Reuse
  - 6. Recycling
  - 7. Materials Sorting and Storage On Site
  - 8. Lists of Recycling Facilities Processors and Haulers
  - 9. Waste Management Plan Form
  
- B. Related Sections:
  - 1. Section 01 00 00 - Basic, General Requirements

##### 1.2 WASTE MANAGEMENT GOALS

- A. Dane County requires that as many waste materials as possible produced as result of this project be salvaged, reused or recycled in order to minimize impact of construction waste on landfills and to minimize expenditure of energy and cost in fabricating new materials. Additional information may be found in Dane County Green Building Policy, Resolution 299, 1999-2000.

##### 1.3 CONSTRUCTION AND / OR DEMOLITION WASTE MANAGEMENT

- A. All construction and demolition waste suitable for recycling [may, must] go to Dane County Construction & Demolition Recycling Facility located at 7102 US Hwy 12, Madison, located across from Yahara Hills Golf Course. This facility can receive mixed loads of construction and demolition waste. For complete list of acceptable materials see [www.countyofdane.com/pwht/recycle/CD\\_Recycle.aspx](http://www.countyofdane.com/pwht/recycle/CD_Recycle.aspx).
- B. Dane County Landfill, also at 7102 US Hwy 12, Madison, must receive all other waste from this project. [www.countyofdane.com/pwht/recycle/landfill.aspx](http://www.countyofdane.com/pwht/recycle/landfill.aspx).

##### 1.4 WASTE MANAGEMENT PLAN

- A. Contractor shall develop Waste Management Plan (WMP) for this project. Dane County's Special Projects & Materials Manager may be contacted with questions. Outlined in RECYCLING section of this specification are examples of materials that can be recycled or reused as well as recommendations for waste sorting methods.

B. Contractor shall complete WMP and include cost of recycling / reuse in Bid. WMP will be submitted to Public Works Project Manager within fifteen (15) business days of Bid Due date. Copy of blank WMP form is in this Section. Submittal shall include cover letter and WMP form with:

1. Information on:
  - a. Types of waste materials produced as result of work performed on site;
  - b. Estimated quantities of waste produced;
  - c. Identification of materials with potential to be recycled or reused;
  - d. How materials will be recycled or reused;
  - e. On-site storage and separation requirements (on site containers);
  - f. Transportation methods; and
  - g. Destinations.

#### 1.5 REUSE

A. Contractors and subcontractors are encouraged to reuse as many waste materials as possible. Salvage should be investigated for materials not reusable on site.

#### 1.6 RECYCLING

A. These materials must be recycled at Dane County Construction & Demolition Recycling Facility:

1. Wood.
2. Wood Pallets.
3. PVC Plastic (pipe, siding, etc.).
4. Cardboard.
5. Metal.

B. These materials can be recycled elsewhere in Dane County area:

1. Barrels & Drums.

C. All materials must be recycled at WDNR permitted waste processing facilities that adhere to all State Statutes.

#### 1.7 MATERIALS SORTING AND STORAGE ON SITE

A. Contractor shall provide separate containers for recyclable materials. Number of containers will be dependent upon project and site conditions.

B. Contractor shall provide on-site locations for subcontractors supplied recycling containers to help facilitate recycling.

C. Mixed loads of recycled materials are allowed only per instructions at [www.countyofdane.com/pwht/recycle/CD\\_Recycle.aspx](http://www.countyofdane.com/pwht/recycle/CD_Recycle.aspx).

#### 1.8 LISTS OF RECYCLING FACILITIES PROCESSORS AND HAULERS

A. Refer to [www.countyofdane.com/pwht/recycle/CD\\_Recycle.aspx](http://www.countyofdane.com/pwht/recycle/CD_Recycle.aspx) for information on Dane County Construction & Demolition Recycling Facility.



- B. Web site [www.countyofdane.com/pwht/recycle/categories.aspx](http://www.countyofdane.com/pwht/recycle/categories.aspx) lists current information for Dane County Recycling Markets. Contractors can also contact Allison Rathack at 608/266-4990, or local city, village, town recycling staff listed at site [www.countyofdane.com/pwht/recycle/contacts.aspx](http://www.countyofdane.com/pwht/recycle/contacts.aspx). Statewide listings of recycling / reuse markets are available from UW Extension at <https://www.uwgb.edu/shwec/>.

## PART 2 PRODUCTS

Not Used.

## PART 3 EXECUTION

Not Used.

END OF SECTION

## WASTE MANAGEMENT PLAN FORM



Contractor Name: \_\_\_\_\_

Address: \_\_\_\_\_

Phone No.: \_\_\_\_\_ Recycling Coordinator: \_\_\_\_\_

MATERIAL	ESTIMATED QUANTITY	DISPOSAL METHOD (CHECK ONE)		RECYCLING / REUSE COMPANY OR DISPOSAL SITE
Salvaged & reused building materials	_____ cu. yds. _____ tons	_____ Recycled	_____ Reused	Name: _____
Wood	_____ cu. yds. _____ tons	_____ Recycled	_____ Reused	Name: _____
Wood Pallets	_____ units	_____ Recycled	_____ Reused	Name: _____
PVC Plastic	_____ cu. ft. _____ lbs.	_____ Recycled	_____ Reused	Name: _____
Asphalt & Concrete	_____ cu. ft. _____ lbs.	_____ Recycled	_____ Reused	Name: _____
Bricks & Masonry	_____ cu. ft. _____ lbs.	_____ Recycled	_____ Reused	Name: _____
Vinyl Siding	_____ cu. ft. _____ lbs.	_____ Recycled	_____ Reused	Name: _____
Cardboard	_____ cu. ft. _____ lbs.	_____ Recycled	_____ Reused	Name: _____
Metals	_____ cu. yds. _____ tons	_____ Recycled	_____ Reused	Name: _____
Unpainted Gypsum / Drywall	_____ cu. yds. _____ tons	_____ Recycled	_____ Reused	Name: _____
Shingles	_____ cu. yds. _____ tons	_____ Recycled	_____ Reused	Name: _____
Fluorescent Lamps	_____ cu. ft. _____ lbs.	_____ Recycled	_____ Reused	Name: _____
Foam Insulation	_____ cu. ft. _____ lbs.	_____ Recycled	_____ Reused	Name: _____
Carpet Padding	_____ cu. ft. _____ lbs.	_____ Recycled	_____ Reused	Name: _____
Barrels & Drums	_____ units	_____ Recycled	_____ Reused	Name: _____

## WASTE MANAGEMENT PLAN FORM

Glass	_____ cu. yds. _____ tons	_____ Recycled _____ Landfilled	_____ Reused _____ Other	Name: _____
Other	_____	_____ Recycled _____ Landfilled	_____ Reused _____ Other	Name: _____
Other	_____	_____ Recycled _____ Landfilled	_____ Reused _____ Other	Name: _____
Other	_____	_____ Recycled _____ Landfilled	_____ Reused _____ Other	Name: _____
Other	_____	_____ Recycled _____ Landfilled	_____ Reused _____ Other	Name: _____
Other	_____	_____ Recycled _____ Landfilled	_____ Reused _____ Other	Name: _____

SECTION 00600

SAMPLE STORAGE AGREEMENT

**SPECIAL PROCEDURE FOR OBTAINING PAYMENT FOR MATERIALS  
NOT STORED AT THE SITE OF THE WORK**

This Agreement applies only to:

Project:

Project No.:

Due to the limited amount of space available for the storage of materials at the site, the Owner, under the following conditions, approves partial payments for certain materials stored off the premises.

1. **Prior Approval:** The Contractor shall obtain the approval of the Owner before making any arrangements to obtain a Certificate for Payment for materials stored off the site. Materials must be suitable for storage and must be properly packaged if this is necessary.
2. **Storage Site:** The Contractor shall furnish and maintain a suitable storage site and proper storage conditions which must be approved in advance by the Engineer assigned to the Project. The site must be within the State of Wisconsin.
3. **Storage Conditions:** The material covered by the request for certification for partial payment must be stored above grade and must be properly protected at all times against weather, heat, cold, moisture, and other hazards as the material may require. The Engineer must approve the storage conditions. All protection must be provided by the Contractor at his own expense and must be maintained throughout the storage period.

Material must not be co-mingled with other similar material, but must be stored by itself and must be plainly labeled **“Property of Dane County Public Works”**.

It must be stored so that it can be readily inspected, measured, and counted at all times by the Engineer.

4. **Bill of Sale:** Request for certification for partial payment for materials stored under the above conditions must be accompanied by a Bill of Sale, properly identifying the material and transferring ownership of the materials to the Owner. The Bill of Sale must be accompanied by an inventory of the stored material together with a description of the storage site by street number and city, or by legal description of the premises.
5. **Insurance:** The Owner shall be notified to cause the builders risk, fire, and extended coverage insurance policy covering this Project to include the materials, stored off site, in the amount and under the same conditions as that provided for material stored on site of the Project. The signing of “Storage Conditions Approved” shall be confirmation that insurance coverage has been provided. Unless specifically exempted by the Owner, the Contractor shall furnish insurance against loss by theft or vandalism, and the Owner shall be named the beneficiary under the policy, as trustee for all concerned. A Certificate of Insurance must be provided the Engineer prior to his approval of this Agreement.

6. **Responsibility:** The Contractor agrees that in accepting partial payments for the stored materials he is in no way relieved of responsibility for the safe storage of the material and its safe transportation and installation in the Work, or for furnishing and installing the material in strict accordance with the Drawings and Specifications.

The Contractor also agrees that acceptance by the Owner of a Bill of Sale for the material does not imply acceptance of the material, which shall be subject to final acceptance or rejection up to the time the Contractor's work is completed and finally accepted.

The Contractor also agrees that the usual guarantee covering his work under the Drawings, Specifications and Contract, are in no way impaired as a result of the partial payment and the acceptance of the Bill of Sale.

The Owner accepts no responsibility in connection with the material.

7. **Acceptance:** The Contractor shall indicate his acceptance of the above conditions by signing and returning one copy of this Storage Agreement.

ACCEPTED:

\_\_\_\_\_  
Signature

\_\_\_\_\_  
Date

\_\_\_\_\_  
Contractor

STORAGE CONDITIONS APPROVED:

SRI Consultants, Inc.

\_\_\_\_\_  
Date

\_\_\_\_\_  
Engineer

Material Stored: \_\_\_\_\_

\_\_\_\_\_

\_\_\_\_\_

\_\_\_\_\_

Storage Site: \_\_\_\_\_

\_\_\_\_\_

- END OF SECTION -

SECTION 00700

GENERAL AND SUPPLEMENTARY CONDITIONS

The “General Conditions of the Contract for Construction” as prepared by Dane County, hereinafter referred to as the “General Conditions” are hereby made part of the Contract Documents.

The General Conditions may be examined at the offices of the Owner and/or Engineer.

**SUPPLEMENTARY CONDITIONS**

These Supplementary Conditions amend or supplement the “General Conditions of the Contract for Construction” as prepared by Dane County. Where any article of the General Conditions is amended, or any paragraph, subparagraph, or clause thereof is amended or deleted by these Supplementary Conditions, the unamended and undeleted provisions of that article, paragraph, subparagraph or clause shall remain in full force and effect.

**ARTICLE 2 - DEFENITIONS**

Add the following Basic Definitions:

**8. PROVIDE**

As used in connection with labor, materials, and equipment shall mean to furnish and install complete, including connections to utilities or service, complete anchorage and suspension, fastening or anchor devices, trim, finish and other related work, unless specifically specified otherwise.

**9. APPROVED, SATISFACTORY, EQUAL TO, PROPER,,AS DIRECTED AND SIMILAR TERMS**

These shall mean the decision rests with the Engineer, whose decision shall be final and binding upon the Contractor and Subcontractor.

**10. NOTICE TO PROCEED**

This shall mean verbal or written notice by the Engineer or Owner to the Contractor to commence Work of the Contract, issued either before or after execution of the Contract. If verbally given, and the Contractor requests, the Notice shall be confirmed in writing. In issuing the Notice, stipulations may be included as to time and other requirements that may condition commencement of the Work.

**ARTICLE 12 – SURVEYS, PERMITS, REGULATIONS AND TAXES**

Add the following Paragraphs:

**H.** Terminology used in this Subsection shall be as defined in Federal Register 40 CFR Part 763, Subpart E - Asbestos-Containing Materials.

**I.** Use of asbestos-containing materials as part of the Work is expressly prohibited. The Contractor shall notify the Engineer, in writing, as to conflicts with this subparagraph and the Specifications so that substitute materials can be investigated and a directive can be issued per Article 7 of the General Conditions. In case of conflict, this subparagraph shall govern.

**J.** The Contractor shall submit Material Safety Data Sheets (MSDS) per Paragraph 3.19 for all suspect products utilized as part of the Work.

## **ARTICLE 21 - CORRECTION OF WORK**

Add the following paragraph:

**C.** Neither the final payment nor any provision in the Contract Documents shall relieve the Contractor of the responsibility for negligence or faulty materials or workmanship within the extent and period provided by the Law.

## **ARTICLE 42 - PROTECTION OF LIVES AND HEALTH**

### **10.1 - SAFETY PRECAUTIONS AND PROGRAMS**

Add the following:

**C.** Terminology used in this Subsection shall be as defined in Federal Register 40 CFR Part 763, Subpart E - Asbestos-Containing Materials.

**D.** Contractor shall contact the Owner and Engineer if asbestos containing building materials (ACBM) or suspected ACBM are uncovered or encountered during the performance of the Work. (Note: This does not pertain to asbestos-containing roofing materials [ACRM] which shall be the responsibility of the Contractor to conform to DHSS 159 regulations.) The Contractor shall not disturb ACBM or suspect ACBM and Work in the area shall be suspended, if necessary to prevent release of asbestos fibers. The Owner shall authorize the Work to proceed following removal of ACBM or bulk sampling to confirm suspected ACBM does not contain asbestos.

**E.** Asbestos management plans are available in the Administrative Office at each building and at Building Services that identifies the locations of asbestos-containing materials. The Contractor, his Subcontractors, and agents shall not disturb friable ACBM nor make non-friable ACBM friable in the course of the Work unless specified herein. Unless it is otherwise expressly provided in the Contract Documents:

**.1** The Owner shall arrange and pay for all costs associated with the bulk sampling of ACBM and suspect ACBM.

**.2** The Owner shall arrange and pay for all costs associated with removal of ACBM and air monitoring.

**.3** The Contractor shall be required to review the site with the Owner prior to start of Work for ACBM or suspect ACBM as it relates to the Work.

**.4** The Contractor shall indemnify and hold harmless the Owner and its Consultants against claims, damages, losses and expenses resulting from the willful or negligent damage of asbestos-containing material during the performance of the Work.

--- END OF SECTION ---



## SECTION 01090

### REFERENCES

#### **PART 1 -- GENERAL**

##### 1.01 References

- A. The standards and Manufacturers' association requirements issued by the following agencies are considered a part of these Specifications. Should conflict occur between Project Specifications and references, Project Specifications shall govern. Referenced material and modifications to each are indicated in each section they apply to. The following is a list of these organizations:

AA	Aluminum Association 818 Connecticut Avenue, NW Washington, DC 10006 (202) 862-5100
AAMA	Architectural Aluminum Manufacturers Association 35 E. Wacker Drive Chicago, IL 60601 (312) 782-8256
ACI	American Concrete Institute Box 19150 Redford Station Detroit, MI 48219 (313) 532-2600
ACIL	American Council of Independent Laboratories 1725 K Street NW Washington, D.C. 20006 (202) 659-3766
AIA	American Institute of Architects 1735 New York Avenue, NW Washington, D.C. 20006 (202) 626-7474
AITC	American Institute of Timber Construction 33 W. Hampden Avenue Englewood, CO 80110 (303) 761-3212
ANSI	American National Standards Institute 1430 Broadway New York, NY 10018 (212) 354-3300

ASHRAE	American Society of Heating, Refrigeration and Air Conditioning Engineers 1791 Tullie Circle NE Atlanta, GA 30329 (404) 636-7722
ASME	American Society of Mechanical Engineers 345 East 47th Street New York, NY 10017 (212) 644-7722
ASPE	American Society of Plumbing Engineers 15233 Ventura Boulevard Sherman Oaks, CA 91403 (213) 783-4845
ASTM	American Society for Testing and Materials 100 Bar Harbor Drive West Conshohocken, PA 19428-2959 (610) 832-9555
AWI	Architectural Woodwork Institute 2310 S. Walter Reed Drive Arlington, VA 22206 (703) 671-9100
AWS	American Welding Society 550 LeJune Road Miami, FL 33135 (305) 642-7090
BHMA	Builders' Hardware Manufacturers Association (c/o TGAM) 60 East 42nd Street, Room 1807 New York, NY 10017 (212) 682-8142
FM	Factory Mutual Engineering Corporation 1151 Boston-Providence Turnpike Norwood, MA 02062 (617) 762-4300

FS	Federal Specification (General Services Admin.) Building 179 Washington Navy Yard, SE Washington, D.C. 10407
MCAA	Mechanical Contractors Association of America 5530 Wisconsin Avenue Washington, D.C. 20015 (202) 654-7960
MIL	Military Standardization Documents (U.S. Dept. of Defense) Naval Publications and Forms Center 5801 Tabor Avenue Philadelphia, PA 19120
MRCA	Midwest Roofing Contractors Association 4840 West 15th Street, Suite 1000 Lawrence, KS 66049 (913) 843-4888
NAAMM	The National Association of Architectural Metal Manufacturers 21 N. LaSalle Street Chicago, IL 60601 (312) 346-1600
NCMA	National Concrete Masonry Association P. O. Box 781 Herndon, VA 22070 (703) 435-4900
NECA	National Electrical Contractors Association 7315 Wisconsin Avenue Washington, D.C. 20014 (301) 657-3110
NEMA	National Electrical Manufacturers Association 2102 L Street NW Washington, D.C. 20037
NFPA	National Fire Protection Association 470 Atlantic Avenue Boston, MA 02210 (617) 482-8755

NRCA National Roofing Contractors Association  
O'Hare International Center  
10255 West Higgins Road, Suite 600  
Rosemont, IL 60018-5607  
(708)-299-9070

OSHA Occupational Safety and Health Administration  
(U.S. Department of Labor)  
Government Printing Office  
Washington, D.C. 20402

PDI Plumbing and Drainage Institute  
5342 Boulevard Pl.  
Indianapolis, IN 46208  
(317) 251-5298

SDI Steel Deck Institute  
P. O. Box 3812  
St. Louis, MO 63122  
(314) 965-1741

SJI Steel Joist Institute  
1703 Parham Road  
Richmond, VA 23229  
(804) 288-3071

SMACNA Sheet Metal and Air Conditioning Contractors' National Association  
8224 Old Courthouse Road  
Vienna, VA 22180  
(703) 790-9890

TIMA Thermal Insulation Manufacturers Association  
7 Kirby Plaza  
Mt. Kisco, NY 10549  
(914) 241-2284

UL Underwriters Laboratories  
333 Pfingsten Road  
Northbrook, IL 60062  
(312) 272-8800

-- END OF SECTION ---

## SECTION 01091

### DEFINITIONS

#### **PART 1 -- GENERAL**

##### 1.01 DEFINITIONS

- A. "Provide" -- Supply materials, products and services as well as furnish labor for installation and completion of items of work mentioned.
- B. "Furnish" -- Design, fabricate, purchase and deliver to the job site or other destination (all at Contractor's expense) as directed by Specification, Owner or Engineer.
- C. "Or Approved Equal" clause -- Where use of "or approved equal" clause appears in reference to a given product, material or item of work, no other product, system, material or item of work will be considered for use in the Work or used as a basis for bidding except when submitted and approved in writing by Engineer as required.
- D. "Or Equal" clause -- Where use of "or equal" clause appears in reference to a given product, materials or items or work, no other products, system, material or item of work shall be used that is not equal in performance, quality, construction and finish to product system, material or item of work specified.
- E. "Debris" -- Rubbish, garbage, empty containers and wrapping and materials that cannot be used in the Work and not to be retained by the Owner.
- F. "Owner" -- Dane County.
- G. "Work" -- Consisting of all labor and operations, transportation, hoisting, materials, tools, equipment, services, inspections, investigations, coordination and supervision required and/or reasonably necessary to produce the construction required by the Contract Documents.
- H. Where "as directed", "as required", "ordered", "prescribed", "approved", "acceptance" or words of similar nature are used, it shall be understood that such words refer to actions to be taken, in writing, by the Contractor unless otherwise stated. The words, "necessary", "suitable", "equal" or words of like import shall mean necessary or equal in the opinion of the Owner and Engineer.
- I. "Install or Installation" -- The act of physically placing, applying, setting, erecting, anchoring, securing, etc. construction materials, equipment, furnishings, appliances and similar items specified and furnished at the job site. Installation of specified items shall be complete in all respects and at the Contractor's expense.
- J. "Asbestos" -- The asbestiform varieties of chrysotile (serpentine); crocidolite (riebeckite); amosite (cummington itegrunerite); anthophyllite; tremolite; and actinolite.
- K. "Asbestos-Containing Material (ACM)" -- When referring to buildings means any material or product which contains more than one percent asbestos.

- L. "Asbestos-Containing Building Material (ACBM)" -- Surfacing asbestos-containing materials (ACM), thermal system insulation ACM, or miscellaneous ACM that is found in or on interior structural members or other parts of a building.
- M. "Asbestos-Containing Roofing Material (ACRM)" -- Roof material composed of asbestos of any type and in an amount greater than 1% by weight, either alone or mixed with other fibrous or nonfibrous materials.

The Contractor is advised to consult the "Glossary" included in the most recent edition of "NRCA Roofing and Waterproofing Manual".

--- END OF SECTION ---

## SECTION 01300

### SUBMITTALS

#### **PART 1 – GENERAL**

##### 1.01 PROCEDURES

- A. Send submittals via e-mail or deliver submittals to Engineer at the office of SRI Consultants, Inc. (SRI), 3207 Laura Lane, Middleton, Wisconsin 53562.
- B. Identify submittals with Contractor's name, Project name and date of submittal.
- C. Make any corrections to the submittals required by Engineer and resubmit until approved. Direct specific attention in writing to revisions on resubmittals other than the corrections requested by the Engineer.

##### 1.02 SUBMITTAL SCHEDULE

- A. Schedule and make all submittals in an orderly sequence so as to cause no delay in the Work or in the work of other Contractors.
- B. Ensure submittals are made far enough in advance of the related Work activity to provide time required for reviews, revisions, resubmittals, approvals, placing orders and securing materials and equipment.
- C. One copy of each submittal is required.
- D. In scheduling, allow at least ten (10) days for review following receipt of a submittal by the Engineer. Allow five (5) days for review of a resubmittal.

##### 1.03 CONSTRUCTION SCHEDULE

- A. Submit work schedule in graph or tabular form for the various phases of the Work including delivery of materials to site, set-up, start-up, tear off (if applicable), recover, phased work (with area designation and key plan), detail reconstructions (if applicable), metal work, etc.
- B. Should any activity critical to the full completion date be, in the judgment of the Engineer, behind schedule by seven (7) or more days, the Engineer may direct the Contractor to expedite the Work to regain compliance with the schedule. If so directed, the Contractor shall promptly expedite the Work by whatever means required including but not limited to, increasing the work force, adding additional shifts and working overtime. Such expediting shall be at no additional cost to the Owner. Failure of the Engineer to so direct shall not relieve the Contractor of his responsibility to comply with the construction schedule.
- C. Submit documents to claim conflicts with the work schedule due to weather, labor, etc. within ten (10) working days of said incident(s) for proper evaluation and action by the Engineer.

#### 1.04 SHOP DRAWINGS AND SAMPLES

- A. Submit all drawings, diagrams, illustrations, schedules, performance charts, instructions, specifications and other product data illustrating portions of the Work as required by the Specification sections. Such submittals, whether or not referred to as shop drawings, shall comply with the requirements for shop drawings herein prescribed. Unless otherwise noted in the Specification sections, submit a minimum of one set of shop drawings to the Engineer.
- B. Submit all samples of materials, equipment and workmanship as required by the Specification sections.
- C. Unless the precise color and pattern is specifically specified in the Specification sections, and whenever a color or pattern is available in a specified product, submit accurate color and pattern charts and samples for review and selection.
- D. Review, stamp with approval and submit all shop drawings and samples required by the Specification sections. Shop drawings or samples submitted without the Contractor's approval stamp will be returned without review.
- E. By approving and submitting shop drawings and samples, the Contractor thereby represents that he has determined and verified all field measurements, field construction criteria, materials, catalog numbers and similar data and that he has checked and coordinated each shop drawing and sample with the requirements of the Work and of the Contract Documents.
- F. Shop drawings and samples will be reviewed and approved by the Owner and/or Engineer to determine in general if they are in compliance with the Contract Documents. Such approval shall not relieve the Contractor of responsibility for any deviations from the requirements of the Contract Documents or from the responsibility for errors or omissions in the shop drawings or samples.
- G. Do not commence any portion of the Work requiring a shop drawings or sample submittal until the submittal has been approved as prescribed herein. All such portions of the Work shall be in accordance with approved shop drawings or samples.

#### 1.05 MATERIAL SAFETY DATA SHEETS

- A. Submit "Material Safety Data Sheets" per Supplementary Conditions, Section 3.19.1.

#### 1.06 CERTIFICATES OF COMPLIANCE

- A. Submit in duplicate, certificates of compliance for each product specified, prior to installation of applicable product.
- B. Certificates of compliance shall include certified laboratory test reports, manufacturer's certificates or other evidence sufficient to verify compliance with the products specified.
- C. Submit all warranties, guarantees, manuals, etc. as described more fully in subsequent sections.



1.07 WAIVER OF LIEN

- A. Submit for approval, duplicate sample of executed Waiver of Lien to be used with each invoice.
- B. Submit letter listing persons approved to sign Waiver of Lien.

--- END OF SECTION ---

## SECTION 01400

### QUALITY REQUIREMENTS

#### **PART 1 -- GENERAL**

##### 1.01 QUALITY OF WORK

- A. Perform all Work in the most workmanlike manner and according to the best standard practices. All Work shall be free from faults and defects in workmanship.
- B. Contractor shall be solely responsible for quality control of the Work and shall maintain quality control over suppliers, manufacturers, products, services, site conditions, and workmanship, to produce work of specified quality.
- C. Required testing and inspection are intended to assist in determination of probable compliances of the Work with the Contract Documents, but do not relieve the Contractor of responsibility for those compliances. Specified testing and inspection are not intended to limit the Contractor's quality control program.

##### 1.02 TESTING AND INSPECTION

- A. Testing and inspection, where required by the Specification sections, shall comply with the specific requirements of the applicable Specification section and general requirements contained herein.
- B. All testing and inspection whether required by the Specification sections or by laws, ordinances, rules, regulations, codes or orders of any public authority having jurisdiction or whether performed by the Contractor for quality control shall be at the Contractor's expense unless otherwise indicated in the Contract Documents.
- C. Fully cooperate and coordinate with the personnel of any testing agency whether performing testing or inspection required by the Contract Documents or any public authority having jurisdiction or performing special testing and inspection required by the Engineer and regardless of whether the testing and inspection has been arranged for by the Contractor, Engineer or a public authority having jurisdiction. Testing agency personnel shall have access to the Work at all time for the performance of such testing and inspection and the Contractor shall provide facilities for access in order that the testing agency may properly perform its function.

##### 1.03 TESTING LABORATORY SERVICES

- A. Where the Specification sections require testing or inspection by a testing laboratory, engage a reputable, independent testing laboratory specializing in the required services unless the testing or inspection is indicated as furnished by the Owner. Testing laboratory shall be approved by the Engineer.
- B. Specimens and samples for testing or inspection shall be taken by the testing laboratory.
- C. Submit written reports of results of such testing or inspection, in duplicate, to the Engineer within three (3) days after completion of the testing or inspection. Reports shall clearly indicate compliance or non-compliance with specified standards and with the Contract Documents.

- D. Secure required certificates of testing, inspection or approval and promptly deliver to the Engineer.
- E. Give the Engineer timely notice of the Work ready to be tested or inspected.
  - 1. Unless the testing or inspection is indicated as furnished by the Owner, give the Engineer timely notice of the date and time arranged so the Engineer may observe the testing or inspection.
  - 2. If the testing or inspection is indicated as furnished by the Owner, the Engineer will arrange for a testing laboratory to perform the required services.
- F. If testing or inspection is indicated as furnished by the Owner, the Owner will engage an independent testing laboratory to perform the required services at the Owner's expense. Any testing or inspection furnished by the Owner shall not constitute acceptance of the Work tested or inspected and shall not relieve the Contractor of his responsibility to comply with the Contract Documents. Written reports of results of testing or inspections furnished by the Owner will be made available to the Contractor upon written request.

#### 1.04 SPECIAL TESTING AND INSPECTION

- A. In addition to testing and inspection required by the Contract Documents, the Engineer may require special testing and inspection as provided in the General Conditions. The Engineer may instruct the Contractor to arrange for such special testing and inspection or may arrange for the special testing and inspection directly. If the Work so tested or inspected is found to be in compliance with the Contract Documents, the cost of testing or inspection shall be charged to the Owner by appropriate Change Order. If the Work is found not to be in compliance, the Contractor shall pay such costs.

--- END OF SECTION ---

## SECTION 01630

### SUBSTITUTIONS AND PRODUCT OPTIONS

#### **PART 1 – GENERAL**

##### 1.01 PRODUCT LIST

- A. Within seven (7) calendar days after award of Contract, submit to Engineer a complete list of major products which are proposed for installation.
- B. Tabulate products by Specification section number and title.
- C. For products specified only by reference standards, list for each sub products:
  - 1. Name and address of Manufacturer.
  - 2. Trade name.
  - 3. Model or catalog designation.
  - 4. Manufacturer's data:
    - a. Referenced standards
    - b. Performance test data.

##### 1.02 CONTRACTOR'S OPTION

- A. For products specified only by reference standards, select products meeting those standards by any manufacturer.
- B. For products specified by naming several products or manufacturers, select any one of the products and manufacturers named which complies with the product specifications.
- C. For products specified by naming one or more products or manufacturers and stating "or equal", submit a request as for substitutions, for any product or manufacturer which is not specifically named.
- D. For products specified by naming only one product and manufacturer, there is no option and no substitution allowed.

##### 1.03 SUBSTITUTIONS

- A. Within a period of seven (7) calendar days after award of Contract, the Engineer will consider formal requests from the Contractor for substitution of products in place of those specified.
  - 1. After the end of that period, requests will be considered only in the case of product unavailability or other conditions beyond the control of the Contractor.
- B. Submit separate request for each substitution. Support each request with:
  - 1. Complete data substantiating compliance of proposed substitution with requirements stated in Specifications.

- a. Product identification including manufacturer's name and address.
  - b. Manufacturer's literature - identify:
    - 1. Product description.
    - 2. Reference standards.
    - 3. Performance test data.
  - c. Samples where applicable.
  - d. Name and address of similar projects on which the product has been used and date of each installation.
- 2. Itemized comparison of the proposed substitutions with product specified. List all significant variations.
  - 3. Data relating to changes in the construction schedule.
  - 4. List of changes required in other work or products.
  - 5. Accurate cost data comparing proposed substitution with products specified.
  - 6. Designation of required license fees or royalties if applicable.
  - 7. Designation of availability of maintenance services and sources or replacement materials.
- C. Substitutions will not be considered for acceptance when:
- 1. They are indicated or implied on shop drawings or product data submittals without a formal request from the Contractor.
  - 2. They are requested directly by Subcontractor or Supplier.
  - 3. Acceptance will require substantial revision to the Contract Documents.
- D. Substitute products shall not be ordered or installed without written acceptance from the Owner or Engineer.
- E. The Engineer will determine acceptability of proposed substitutions.

#### 1.04 APPROVED EQUAL PRODUCT OPTION

- A. Within a period of three (3) calendar days prior to the Bid Due Date, the Engineer will consider formal requests from the Contractor for "approved equal" substitutions.
- B. Each request for Engineer approval consideration shall be prepared and submitted as set forth in Subsection 1.03 -- Substitutions.

#### 1.05 CONTRACTOR'S REPRESENTATION

- A. In making form requests for substitution or approved equals, the Contractor represents that:
1. He has investigated the proposed product and he has determined that it is equal to or superior in all respects to that specified.
  2. He will provide same warranties or bonds for substitution as for product specified.
  3. He will coordinate installation of accepted substitution into the Work and will make such changes as may be required for the Work to be complete in all respects.
  4. He waives all claims for additional costs caused by the substitution which may subsequently become apparent.
  5. Cost data is complete and includes related costs under his Contract but not:
    - a. Costs under separate Contracts.
    - b. Engineer's costs for redesign or revision of Contract Documents.

#### 1.06 ENGINEER'S DUTIES

- A. Review Contractor's requests for substitutions with reasonable promptness. Notify the Contractor in writing of decision to accept or reject requested substitutions.

--- END OF SECTION ---

## SECTION 02070

### DEMOLITION

#### **PART 1 -- GENERAL**

##### 1.01 CONDITIONS OF THE CONTRACT

- A. The conditions of the Contract (General, Supplementary, and Other Conditions) and the requirements of Division 1, are hereby made a part of this Section. Applicable provisions of Division 1 shall govern Work under this Section.

##### 1.02 WORK INCLUDED

- A. Provide all labor, materials, services and incidentals necessary to perform the following work:
  - 1. Remove and dispose of existing roof ballast, membrane and insulation as shown on the Drawings.
  - 2. Remove and dispose of existing metal work and associated with the roof system.
  - 3. Remove and dispose of all contingent materials as required and specified. If Asbestos containing materials are encountered, Dane County Public works will properly remove and dispose of the material.
  - 4. Disconnection and reconnection of all HVAC units as required.

##### 1.03 RELATED SECTIONS

- A. Section 06010 – General Carpentry.
- B. Section 07201 - Insulation.
- C. Section 07531 – Elastomeric Sheet Roofing-Fully Adhered
- D. Section 07620 - Sheet Metal Flashing and Trim.
- E. Section 07900 - Sealants.

##### 1.04 REGULATORY REQUIREMENTS

- A. The following regulatory agencies' requirements shall be enforced:
  - 1. Occupational Safety and Health Administration (OSHA).
  - 2. Wisconsin Administrative Code.
  - 3. United States Department of Transportation (US DOT).

4. Environmental Protection Agency (EPA).
5. National Emission Standards for Hazardous Air Pollutants (NESHAP).
6. In Wisconsin:
  - a. Department of Natural Resources (DNR).
  - b. Department of Health and Social Services (DHSS).
- B. The Contractor shall perform all Work in accordance with State of Wisconsin Department of Health and Social Services, HSS 159.
- C. The Engineer on this Project is not an advisor of asbestos-related issues. The Contractor shall consult the Owner's Asbestos Consultant for clarifications.

#### 1.05 PROTECTION

- A. When Work involves removal of roofing materials, the following **minimum** requirements shall be enforced:
  1. The Contractor shall exercise extreme caution and take all necessary precautions to limit exposing his workmen or bystanders to any dangerous conditions.
  2. Protect all existing utilities against damage. Maintain existing utilities during demolition operations.
  3. Protect passageways and maintain all exit ways to ensure the safe passage of persons around the area of demolition.
  4. Conduct operations in a manner that will prevent damage by falling debris, or other causes.
  5. Provide interior and exterior shoring, bracing, or support required to prevent movement, settlement, or collapse of adjacent facilities indicated to remain.
  6. Protect all remaining portions of the building and property not scheduled for demolition. These areas shall be completely protected during demolition and removal of debris. Any resulting damage shall be repaired or replaced to like-new condition by the Contractor responsible under the direction and approval of the Owner or Engineer.
  7. Cover air vents designated by the Owner with filter fabric or plastic sheet to prevent visible dust and debris from entering the building. Remove filter fabric or plastic sheet upon job completion.
  8. When the Work involves removal of roofing materials containing asbestos, notify the Owner's Asbestos Consultant immediately for proper removal procedural information.



## 1.06 OCCUPANCY

- A. The Owner shall occupy the building during demolition and construction and the facility shall remain operational.
- B. Coordinate all Work in advance with the Owner.

## 1.07 DUST CONTROL

- A. The following **minimum** requirements will be enforced:
  - 1. It is imperative that dust be kept to a minimum during removal of the roofing system.
  - 2. Debris shall be transported on covered trucks.
  - 3. Debris shall be removed as it accumulates.
  - 4. As it pertains to interior conditions, no excessive disturbance of the structure which causes airborne debris will be tolerated.

## **PART 2 -- EXECUTION**

### 2.01 DEMOLITION IN STRUCTURES AND CONSTRUCTION TO REMAIN

- A. Remove existing construction and equipment including ballast, roofing membrane, insulation, flashings, sheet metal, blocking as required to complete the installation of new roofing Work as shown or specified.
- B. Coordinate all HVAC disconnect and reconnect work with a service technician approved by the HVAC unit Manufacturer.
- C. Do not start tear off of existing materials when inclement weather is expected.
- D. Refer to Subsection 1.05 PROTECTION for requirements relating to protection of existing structure and property.
- E. Provide protective devices, enclosures, rails and similar items necessary to provide for normal public passage and to prevent bodily injury to occupants of the building.
- F. Use of the building, or any of its mechanical or electrical systems, shall not be curtailed without prior agreement with the building Owner.
- G. Conduct demolition operations and the removal of debris to ensure minimum interference with roads, walks and other adjacent occupied or used facilities.
- H. If during the course of the demolition work portions of the existing structure are opened to the weather, it shall be the Contractor's responsibility to close such openings as required in a weathertight manner at the end of each work day.

## 2.02 DISPOSAL OF MATERIALS

- A. All demolition material not schedule for re-use shall be removed from the Owner's site by the Contractor.
  - 1. No prolonged accumulation of debris will be allowed.
  - 2. Remove all salvaged items from the site as demolition progresses. Storage or sale of removed items on the site will not be allowed.
  - 3. The Contractor is responsible for the proper location and method of disposal for each individual component of the roofing system.
  - 4. The site is to be broom clean at the end of each working day.
- B. No burning on site will be permitted.

--- END OF SECTION ---

SECTION 06010  
GENERAL CARPENTRY

**PART 1 -- GENERAL**

1.01 CONDITIONS OF THE CONTRACT

- A. The conditions of the Contract (General, Supplementary, and Other Conditions) and the requirements of Division 1 are hereby made a part of this Section. Applicable provisions of Division 1 shall govern Work under this Section.

1.02 WORK INCLUDED

- A. This Section includes all labor, material, equipment, and related services necessary to perform the following Work:
  - 1. Furnish and install wood framing, bracing, blocking and curbing as required and as shown on the Drawings.

1.03 RELATED SECTIONS

- A. Section 02070 – Demolition.
- B. Section 07201 - Insulation.
- C. Section 07531 - Elastomeric Sheet Roofing- Fully Adhered.
- D. Section 07620 - Sheet Metal Flashing and Trim.
- E. Section 07900 - Sealants.

1.04 QUALITY ASSURANCE

- A. Existing wood members, intended for re-use that are found not to be in satisfactory condition, are to be replaced with equivalent products. Replacement Work shall be by Change Order.
- B. Existing construction may not be as shown on the Drawings and some modification of details may be required to accomplish the intent of the Contract Documents. All modifications or adjustments are to be approved in advance by the Engineer.
- C. No Work of this Section is to be installed unless it can be completely protected from exposure to the weather by the specified flashing the same day Work is installed.
- D. Any grouting, shimming, patching or filling of existing construction required to properly install wood members is the responsibility of the Contractor.
- E. There shall be no deviation made from this Specification or the approved shop drawing without prior written approval by the Engineer.

- F. Shop drawings of proposed alternate details shall be submitted to the Engineer for approval prior to the start of construction.
- G. Proposed alternate details and installation procedures shall comply with the Specifications and Drawings.

#### 1.05 REGULATORY REQUIREMENTS

- A. Materials and construction shall meet the following:
  - 1. Underwriters Laboratories, Inc. (UL): Standards UL 723 and Subject 1040 Conformance.
  - 2. Factory Mutual Engineering Corporation (FM): FM Data Sheets 1-0, 1-1, 1-21, and 1-23; Fire Classification, Class 1 (FM Approval Standards).
  - 3. International Conference of Building Officials, Uniform Building Code (UBC).
  - 4. Regional, State, and Local Building Codes and/or Ordinances.

#### 1.06 SPECIAL CONTRACTOR REQUIREMENTS

- A. The Contractor shall provide a Project Foreman with a minimum of five (5) years documented experience in the supervision of general carpentry and shall be knowledgeable in the type of construction specified herein.
- B. The Contractor's Foreman shall be present on the job site for the entirety of the Work and shall be accessible at all times to ensure good project coordination and communication.
- C. All Work that requires saw cutting, vacuuming, and other similar functions that create substantial noise and/or vibration shall be coordinated well in advance of the Work with the Owner and the Engineer.
- D. Take all necessary precautions to protect the Owner's property as well as adjacent property, including trees, shrubs, buildings, sanitary and storm sewers, water piping, gas piping, electric conduit or cable, etc., from any and all damage which may result due to Work on this Project.

#### 1.07 SUBMITTALS

- A. Submit shop drawings as required. Drawings shall show all other details required for proper lumber installation that are not shown in or that differ from the Specifications and Drawings.
- B. Submit a list of materials (as outlined in 2.02 Materials) for use in the Work.
- C. One e-mail copy of each submittal is required.

#### 1.08 PRODUCT DELIVERY, STORAGE AND HANDLING

- A. Delivery and Storage of Materials.

1. Deliver all materials in their original unopened containers with all markings intact.
2. Store all materials in a dry place or otherwise protect from water or extreme humidities. Cover with a breathable covering, such as canvas. Covering shall extend to base of stack on all sides.
3. Store cements and adhesives in the manner and temperature range recommended by the individual Manufacturers.

**B. Handling Materials**

1. Handle materials to avoid bending, breaking or otherwise damaging them during transportation and installation.
2. Do not store materials on the roof in a manner that may exceed the live load capacity of the deck system or the structure. The Engineer, during routine observations, may make recommendations as to loading.
3. Do not transport materials over or store materials on a roof section without prior approval of the Engineer.

**1.09 GUARANTEES, WARRANTIES, CERTIFICATES**

- A. Materials and/or workmanship shall be guaranteed against all defects for a period of three (3) years from the date of Substantial Completion.

**PART 2 -- PRODUCTS**

The Contractor is responsible for furnishing the following materials in the amount required for completion of the entire Project specified herein.

**2.01 ACCEPTABLE MANUFACTURERS**

- A. Provide products by Manufacturers specified herein which meet or exceed standards as set forth in this Section. No materials specified or approved shall contain asbestos.
- B. All materials shall be new unless noted otherwise.

**2.02 MATERIALS**

- A. Lumber, Nailers and Blocking: Kiln-dried, grade marked, mill tradesmarked according to the National Lumber Manufacturer's Association; Douglas Fir #2 grade or better of Hemlock or White Fir construction grade or better. Lumber stress grade shall be 1,150 psi minimum (E = 1,150 psi). 2 X 4 (minimum) studs required. Moisture content shall be less than 19 percent at the time of installation.
- B. Sheathing: 3/4" and 1" American Plywood Association (APA) exterior rated 4-ply CDX fir, non-preserved treated meeting U.S. Products Standard PS1 or Performance Standard PRP-108 for soft plywood construction. Moisture content shall be less than 19 percent at the time of installation.

- C. Fasteners: Space fasteners as shown on the Drawings or as specified herein:
1. Nails used to secure lumber to other wood members shall have galvanized metal consistency, and shall be long enough to penetrate 1-1/4". Two rows are required, staggered when feasible. Spacing in any one row shall not exceed 24". Spacing shall not exceed 12", 8' each way from outside corners. Withdrawal resistance shall be 100 pounds per nail minimum. (Lag screws of equivalent strength may be used if desired.)
  2. Fasteners used to secure lumber to masonry or concrete shall be 1/2" minimum diameter metal expansion stud anchors in pre-drilled holes such as Kwik-Bolt Stud Expansion Anchor by Hilti, Inc. or approved equal. Space fasteners at 12" o.c. (maximum).
  3. Fasteners used to secure plywood to substrate shall be long enough to penetrate 1-1/4". Two rows are required on horizontal surfaces. Rows shall be staggered 16" o.c. Three rows are required on vertical surfaces. Outer rows shall be staggered 16" o.c., inner row shall be 32" o.c. as shown on drawings. Fasteners shall be 1/4" Blue Climaseal Tapcon concrete fasteners or approved equal.
  4. Fasteners used to secure metal to metal shall be hardened, self-tapping, sheet metal gimlet point type, with hex/washer head, and be of compatible material. Space fasteners at 12" o.c. (maximum).
5. Other fasteners not specifically described shall be as selected by the Contractor subject to approval by the Engineer.
- D. Batt Insulation: ASTM C665, FS HH-I-521E, Type I, nominal 4" thick fibrous glass blanket, designated R-value equals 13. (See Section 07200 - INSULATION.)
- E. Other Materials: All other materials, not specifically described but required for a complete and proper installation of the Work in this Section, shall be as selected by the Contractor subject to approval by the Engineer.

## **PART 3 -- EXECUTION**

### **3.01 EXAMINATION**

- A. The Contractor shall have the sole responsibility for the accuracy of all measurements and for the estimate of material quantities required and necessary to satisfy the requirements of these Specifications.

### **3.02 SEQUENCING/SCHEDULING**

- A. Remove only as much exterior protection as can be restored to a weathertight condition each day or before showers commence.
- B. All contingent flashings shall be completed each day on the worked section.

### 3.03 SUBSTRATE PREPARATION

- A. Remove existing materials as required to complete the Work.
- B. Scrape, broom and/or repair existing surfaces to insure that the substrate is smooth, clean. If roof deck is wet, dry surface with back pack blower before applying any materials. Assure that surfaces are completely dry and free from any sharp projections and depressions prior to the start of installation of the Work.

### 3.04 OTHER REPAIRS AND CONSTRUCTION

- A. Furnish new wooden nailers and blocking for installation areas and applicable details.
- B. Install new lumber in place of existing rotted or otherwise deteriorated lumber not originally scheduled for replacement. Repairs shall be by Change Order.
- C. Assure all existing structural material is sound and secured properly prior to construction. Notify Engineer of any inconsistencies.

### 3.05 ROUGH CARPENTRY - INSTALLATION

- A. Install new wood members accurately, rigidly framed, closely fitted, plumb and true and securely anchored. Stud spacing shall not exceed 16" in any instance.
- B. Shim and brace Work properly to insure solid bearings and true alignment.
- C. Install all miscellaneous items required to complete installation.
- D. Provide rough openings as required.
- E. Provide wood nailers and/or blocking wherever shown on the Drawings and where required for attachment of other Work. Form to shapes as shown and cut as required for true line and level of Work to be attached. Set true to line, level and plumb with intersections true to required angle, if applicable. Coordinate location with other Work involved.
- F. Attach all Work to substrates securely with fasteners per this Section as required to support applied loading. Countersink fasteners flush with surfaces, unless otherwise shown.

--- END OF SECTION ---

## SECTION 07201

### INSULATION

#### **PART 1 -- GENERAL**

##### 1.01 CONDITIONS OF THE CONTRACT

- A. The conditions of the Contract (General, Supplementary, and Other Conditions) and the requirements of Division 1, are hereby made a part of this Section. Applicable provisions of Division 1 shall govern the Work under this Section.

##### 1.02 WORK INCLUDED

- A. This Section includes all labor, material, equipment and related services necessary to perform the following Work:
  - 1. Clean and repair roof deck or pertinent substrate as required to receive insulation.
  - 2. Furnish and install new rigid board insulation system.
  - 3. Furnish and install new wood blocking incidental to the insulation Work.

##### 1.03 RELATED SECTIONS

- A. Section 02070 - Demolition.
- B. Section 06010 – General Carpentry.
- C. Section 07531 – Elastomeric Sheet Roofing – Fully Adhered.
- D. Section 07620 - Sheet Metal Flashing and Trim.
- E. Section 07900 - Sealants.

##### 1.04 QUALITY ASSURANCE

- A. The Insulation Manufacturer shall have a minimum ten (10) years experience specializing in roof insulations.
- B. The Contractor shall have a minimum five (10) years documented experience specializing in installing insulation systems.
- C. The insulation system must be applied by a Roofing Contractor authorized by the Insulation System Manufacturer.
- D. All components used in the insulation system shall be approved by the Insulation Manufacturer.
- E. There shall be no deviation made from this Specification or the approved shop drawings without prior written approval by the Manufacturer and Engineer.



- F. Shop drawings of proposed alternate details shall be submitted to the Engineer for approval two weeks prior to the start of construction.
- G. Proposed alternate details and application procedures shall comply with the Specifications, Drawings, and Manufacturer's recommendations.
- H. The Contractor shall keep a copy of the Insulation Manufacturer's installation instructions and these Specifications on site at all times.

#### 1.05 REGULATORY REQUIREMENTS

- A. Materials and construction shall meet the following:
  - 1. Underwriters Laboratories, Inc. (UL): Class A Fire Hazard Classification.
  - 2. Factory Mutual Engineering Corporation (FM): Windstorm Resistance Classification, FM Data Sheets 1-28 (September, 1991 Revision) and 1-49 (Class I-90 Construction); Fire Classification, Class 1 (FM Approval Standards).
  - 3. International Conference of Building Officials, Uniform Building Code (UBC).
  - 4. Regional, State, and Local Building Codes and/or Ordinances.

#### 1.06 REFERENCES

- A. References shall refer to the most recent standard.
  - 1. American Society for Testing and Materials (ASTM).
  - 2. Federal Specifications (FS).
  - 3. Factory Mutual Engineering Corporation (FM).

#### 1.07 SPECIAL ROOFING CONTRACTOR REQUIREMENTS

- A. The Contractor shall provide a Project Foreman with a minimum of five (5) years documented experience in the supervision of insulation system installation and shall be knowledgeable in the type of insulation system specified herein.
- B. The Contractor shall not change Foreman or crew without prior approval of the Engineer.
- C. The Contractor's Foreman shall be present on the job site during the majority of work hours and shall be accessible at all times to ensure good Project coordination and communication.
- D. During the workday should the weather conditions appear to be changing adversely, the Foreman shall take preventative measures to allow the roof to be closed to a watertight condition to avoid exposure of buildings, equipment and materials.

- E. All Work that requires saw cutting, vacuuming and other similar functions that create substantial noise and/or vibration shall be coordinated well in advance of the Work with the Owner and the Engineer.
- F. Prior to the start of the Project, and daily after the start, the Contractor shall review the type of space below the roof being worked on to ensure that all special requirements because of occupancy type are complied with prior to the start of the Work.
- G. Take all necessary precautions to protect the Owner's property as well as adjacent property, including trees, shrubs, buildings, sanitary and storm sewers, water piping, gas piping, electric conduit or cable, etc., from any and all damage which may result due to Work on this Project.
- H. Repair any Work, damaged by failure to provide proper and adequate protection, to its original state to the satisfaction of the Owner or remove and replace with new Work at the Contractor's expense.

#### 1.08 SUBMITTALS

- A. Submit shop drawings as required. Drawings shall show details required for proper insulation system installation that are not shown in or that differ from the Specifications and Drawings.
- B. Submit a list of materials for use in the Work.
- C. Submit product data for the insulation system(s).
- D. Submit Insulation Manufacturer's installation instructions.
- E. One e-mail copy of each submittal is required.

#### 1.09 PRODUCT DELIVERY, STORAGE AND HANDLING

- A. Deliver all materials in Manufacturer's original, unopened containers with Manufacturer's labels intact and legible.
- B. Stack insulation at least 4" above the ground on pallets and cover with a breathable covering, such as canvas. The covering shall extend to grade on all sides. Protect foam insulations from direct exposure to sunlight. Translucent plastic wrap as provided by the Manufacturer for shipping will not constitute adequate protection.
- C. Materials shall be stored so as to protect them completely from damage by the elements and temperatures. Storage of materials on ground and/or rooftop shall be protected with waterproof canvas covering and stored on raised platforms. The use of pallets or similar type equipment will be acceptable.
  - 1. Waterproof canvas covering shall be applied in a watertight manner and securely tied at the end of each work day or work period.

2. Use of the Manufacturer's product protection wrapping is not acceptable for worksite type protection. Wrapping shall be side-punctured or end-punctured or slashed before covering with canvas.
  3. No tears in the waterproof canvas covering will be allowed.
- D. Material storage in warehouse, storage trailer, or tent is recommended.
- E. Keep lids tightly sealed on all emulsions, solvent based adhesives, and cements to keep volatiles from escaping.
- F. Handling Materials
1. Do not store or transport insulation materials on the roof in a manner that may exceed the live load capacity of the deck system or the structure. The Engineer, during routine observations, may make recommendations as to loading.
  2. Do not transport insulation materials over or store materials on a finished section, without prior approval from the Engineer.

#### 1.10 ENVIRONMENTAL REQUIREMENTS

- A. Do not apply insulation during inclement weather or when air temperature is below (or is expected to be below) 40°F (5°C).

#### 1.11 GUARANTEES, WARRANTIES, CERTIFICATES

- A. Furnish two copies of the following to the Engineer:
1. Manufacturers System Warranty: The Contractor shall warrant, in writing, all insulation materials for a period of twenty (20) years following completion and that the insulation system has been installed according to material Manufacturer's current specifications. The warranty shall cover labor and materials. (Refer to warranty under section 07531).

### **PART 2 -- PRODUCTS**

The Contractor is responsible for furnishing the following materials in the amount required for completion of the entire Project specified herein.

#### 2.01 ACCEPTABLE MANUFACTURERS

- A. Provide products by Manufacturers specified herein which meet or exceed standards as set forth in this Section. No materials specified or approved shall contain asbestos.
- B. All materials shall be new unless otherwise noted.

#### 2.02 MATERIALS

A. Insulation

1. Flat Stock:

- a. Polyisocyanurate: (Base layer of tapered system to be 1.5 inches thick) Rigid board insulation as recommended by the roof system manufacturer and as approved by Architect/Engineer. Fiberglass facers are required; 4' X 8' maximum board size; maximum thickness 1.5 inches. Conform to FS HH-1972/2 Class 1. "Iso 95+" as manufactured by Firestone Building Products or approved equal.
- b. High Density Roof Cover Board: High Density polyisocyanurate rigid board with coated fiberglass facers 4' x 4' maximum board size. "Isogard HD Cover Board" as manufactured by Firestone Building Products or approved equal.

2. Tapered:

- a. Polyisocyanurate: 1/8" designated per foot slope (base layer of tapered system to be 1.5 inches thick) with polyisocyanurate board fill (not to exceed 1-1/2" thickness) as recommended by the roof system manufacturer and as approved by Architect/Engineer. Minimum starting thickness 1.5" or as approved by Architect/Engineer. Fiberglass facers are required. Conform to FS HH-1972/2 Class 1. Note: Maximum thickness of any tapered insulation board to be 1.5 inches. "Iso 95+ tapered" as manufactured by Firestone Building products or approved equal
- b. Saddles and Crickets: 1/4" per foot finished slope (except as noted on the Drawings) as recommended by the roof system manufacturer and as approved by Architect/Engineer. Fiberglass facers are required; 4' X 8' maximum board size; maximum thickness 1.5 inches. Conform to FS HH-1972/2 Class 1.
- c. Insulation/Cover Board Adhesive: Shall be two part polyurethane bead adhesive. "I.S.O. Stick" as manufactured by Firestone Building Products or approved equal.

B. Fasteners (Miscellaneous):

1. Nails used to secure wood such as fascias, cant strips, blocking and nailers to other wood members shall be galvanized and long enough to penetrate 1-1/4". Two rows are required, staggered when feasible. Spacing in any one row shall not exceed 24". Spacing shall not exceed 12", 8' each way from outside corners. Withdrawal resistance shall be 100 pounds per nail minimum. (Lag screws of equivalent strength may be used if desired.)
2. Fasteners used to secure lumber to masonry or concrete shall be 1/2" minimum diameter metal expansion stud anchors in pre-drilled holes such as "Kwik-Bolt II Stud Expansion Anchor" by Hilti, Inc. or as approved by Architect/Engineer. Space fasteners at 12" o.c. (maximum).

3. Other fasteners not specifically described shall be as selected by the Contractor subject to approval by the Engineer. All fasteners shall meet the requirements set forth in FM Data Sheet 1-28 and 1-49 as appropriate.
- G. Flame Resistant Foil Faced Building Insulation: ASTM C665, Type III, Class A fiberglass blanket such as “FSK-25” by CertainTeed or as approved by Architect/Engineer.
- H. Lumber, Nailers and Blocking: #2 grade wood (lumber) or better.
- I. Plywood: (Thickness as shown on the Drawings) APA exterior rated 4-ply CDX with salt preservative pressure treatment (0.40 pcf minimum retention).
- J. Batt Insulation: ASTM C665, FS HH-I-521, Type I, nominal 4” thick fiberglass blanket.
- K. Other Materials: All other materials, not specifically described but required for a complete and proper installation of the Work in this Section, shall be as selected by the Contractor subject to approval by the Engineer.

### **PART 3 – EXECUTION**

#### **3.01 DEFINITIONS**

- A. The term “phased construction” or “phased application” shall mean the insulation system construction or application process in which all parts of cross-section of a roofing system, including the vapor retarder, roof insulation, roof membrane and surfacing are not completed for a particular roof area during one day or work period.

#### **3.02 EXAMINATION**

- A. The Contractor shall have the sole responsibility for the accuracy of all measurements and for the estimate of material quantities required and necessary to satisfy the requirements of these Specifications.

#### **3.03 SUBSTRATE PREPARATION**

- A. Remove the existing membrane and insulation as shown on the drawings (as described in Section 02070 - Demolition). (Note: No saw-cutting of the deck is permitted. Position blade so depth of cut lies within the thickness of the existing roof system.)
- B. Scrape, broom, repair and/or replace deck to insure that the substrate is smooth, clean, dry and free from any sharp projections and depressions prior to the start of installation of the new insulation system. Any wet deck areas shall be dried completely with a back pack blower.
- C. Deck Repairs (Note: Deck repairs, if needed, shall be as directed by the Engineer and shall be by Change Order.)

#### **3.04 WORKMANSHIP**

- A. All insulation Work shall be accomplished with non-working Foreman overseeing the work of workers who are thoroughly skilled in the application of specified materials. All workmanship to be of the very best, and shall be done in such a manner as to fulfill the requirements of the Drawings and Specifications.
- B. Weather Condition Limitations: Proceed with insulation Work only when existing and forecasted weather conditions will permit Work to be performed in accordance with the requirements of this Specification.
- C. After starting the Work, the Contractor shall be responsible for complete moisture integrity of the insulation system. Therefore, the Contractor shall:
  - 1. Establish and follow application procedures to insure that adequate quantities of materials are used.
  - 2. Maintain competent Foreman continuously supervising the Work, with authority to discard unsuitable materials and remove unsatisfactory workmen from the Project.
  - 3. Observe all fire precautions involving the storage and handling of insulation materials. Provide adequate quantity of fire extinguishers at the worksite, especially at the kettles, torches, or open flames.
  - 4. Comply with current insulation safety standards at all times.
  - 5. Supervise installation of and be responsible for seeing that roof mechanical and electrical equipment, roof drains, etc. are properly set without damage to the roof. Make roof and flashing repairs as necessary and advise the Engineer in writing of all potential leaks as may be caused by other trades not under the Contractor's control.
  - 6. Under no conditions shall any insulation materials be applied before sunrise, or at anytime when there are indications of moisture present (rain, mist, dew, frost, and snow).
  - 7. Install only as much insulation material as can be completed and covered in accordance with the requirements of this Specification in any one day or work period.
  - 8. The Contractor shall install flashings at openings, projections and walls adjoining new Work every day or work period. If circumstances do not allow this, these areas shall be made watertight at the end of each day or work period.
  - 9. At the end of each day's Work, install temporary water cut-offs at all points where the roof membrane does not abut a wall, wood edge member or expansion joint. The water cut-off shall be removed completely before continuing the roof installation. If breaks occur in the water cut-offs or any other part of the roof membrane and water damages the roof insulation, all damaged roof insulation, vapor retarder and roof membrane over the damaged insulation shall be removed and replaced with new materials. Contractors option:

10. Comply with other workmanship requirements as outlined in other Sections of this Specification.
- D. The following cold weather (below 40°F) precautions shall be followed when applying the roof membrane system to insure proper performance of this Specification.
  1. Store materials in a heated environment up to one hour immediately prior to installation.

### 3.07 OTHER REPAIRS AND CONSTRUCTION

- A. Furnish new wood nailers and blocking for roof installation areas and details applicable.
- B. Install new lumber in place of existing rotted or otherwise deteriorated lumber not originally scheduled for replacement. Repairs shall be by Change Order.
- C. Install new wood nailers to match height of total insulation thickness at applicable areas.
- D. Assure all existing structural material is sound and secured properly prior to construction. Notify the Engineer of any inconsistencies.

### 3.09 ROOF INSULATION - INSTALLATION

1. Remove all existing roof membrane and insulation as indicated on the drawings.
2. Insure substrate is clean and free of debris and completely dry.
3. Install base layer of insulation system in bead adhesive according to FM 1-90.
4. Install remaining layers of insulation and coverboard layer of insulation using bead adhesive. All layers shall be adhered according to FM 1-90.
5. Allow foam to rise as required before placing insulation and coverboards.
6. Make sure boards are weighted for the appropriate amount of time before installing additional materials.
7. Install cover board in similar fashion over the insulation system, making sure that foam rises before the board is installed and that once install the board is wieghted allowing the adhesive to properly bond.
8. Cut or score insulation boards to conform to angles of new substrate.
9. Ensure close fit and alignment of all insulation boards limiting any gaps to 1/8" maximum. Stagger all board joints within the field of the roof. Offset the end and side joints a minimum of 6" from the joints of the preceding layer.

10. Cover all installed insulation with roofing membrane by the end of each working day and before rain showers commence.

--- END OF SECTION ---



SECTION 07531  
EPDM SHEET ROOFING - FULLY ADHERED

**PART 1 -- GENERAL**

1.01 CONDITIONS OF THE CONTRACT

- A. The conditions of the Contract (General, Supplementary and Other Conditions) and the requirements of Division 1, are hereby made a part of this Section. Applicable provisions of Division 1 shall govern Work under this Section.

1.02 WORK INCLUDED

- A. This Section includes all labor, material, equipment and related services necessary to perform the following Work:
  - 1. Furnish and install new fully adhered EPDM roof membrane.
  - 2. Furnish and install new fully adhered EPDM roof flashing.
  - 3. Furnish and install new flashings at all drains and vent details.
  - 4. Coordinate the installation of new metal Work incidental to the roofing Work.
  - 5. Repair or replace adjacent roof areas that are damaged by the roofing Contractor.

1.03 RELATED SECTIONS

- A. Section 02070 - Demolition.
- B. Section 06010 – General Carpentry.
- C. Section 07201 - Insulation.
- D. Section 07620 - Sheet Metal Flashing and Trim.
- E. Section 07900 - Sealants.

1.04 QUALITY ASSURANCE

- A. The membrane Manufacturer shall have a minimum ten (10) years experience specializing in elastomeric sheet roof membranes.
- B. The Contractor shall have a minimum five (10) years documented experience specializing in elastomeric sheet roof membranes.
- C. The roof system must be applied by a roofing Contractor authorized by the roof system Manufacturer.
- D. The membrane Manufacturer shall approve all components used in the roof system.
- E. At the start of new membrane installation, Manufacturer's Representative shall visit the job site to ensure that the installation begins correctly with all installation procedures and guidelines being followed and notify the Engineer of his findings. Failure to notify hereby constitutes acceptance of

SECTION 07531  
EPDM SHEET ROOFING - FULLY ADHERED

the Work of his licensed applicator (the Contractor) by the Manufacturer.

- F. Upon 50 percent completion of the Project, the roof membrane Manufacturer's Representative shall inspect the installation for adherence to installation procedures and guidelines. The installation shall be inspected more frequently if deemed necessary by the Manufacturer, Engineer, Owner or Contractor.
- G. Upon completion of the installation, an inspection shall be made by a representative of the roof membrane Manufacturer to ascertain that the roof system has been installed according to the applicable roof membrane Manufacturer's specifications.
- H. All the above indicated job visits shall be documented in writing by the roof membrane Manufacturer's Representative indicating all problems, concerns, recommendations and directives given to the roofing Contractor regarding roof system installation. Copies shall be provided to Engineer within ten (10) days of the inspection date.
- I. It is the roofing Contractor's responsibility to arrange the Manufacturer's inspections.
- J. There shall be no deviation made from this Specification or the approved shop drawing without prior written approval by the Manufacturer and Engineer.
- K. Shop drawings of proposed alternate details shall be submitted to the Engineer for approval prior to the start of construction.
- L. Proposed alternate detail and application procedures shall comply with Specification, Drawings and Manufacturer's recommendations.
- M. The Contractor shall keep a copy of the membrane Manufacturer's installation instructions and these Specifications on site at all times.

1.05 REGULATORY REQUIREMENTS

- A. Materials and construction shall meet the following:
  - 1. Underwriters Laboratories, Inc. (UL): Class A Fire Hazard Classification.
  - 2. Factory Mutual Engineering Corporation (FM): Windstorm Resistance Classification, FM Data Sheets 1-28 (September, 1991 Revision) and 1-49 (Class I-90 Construction); Fire Classification, Class 1 (FM Approval Standards).
  - 3. International Conference of Building Officials, Uniform Building Code (UBC).
  - 4. Regional, State, and Local Building Codes and/or Ordinances.

1.06 REFERENCES

- A. References shall refer to the most recent standard.
  - 1. American Society for Testing and Materials (ASTM).
  - 2. Federal Specifications (FS).

SECTION 07531  
EPDM SHEET ROOFING - FULLY ADHERED

3. Factory Mutual System (FM).

1.07 SPECIAL ROOF CONTRACTOR REQUIREMENTS

- A. The Contractor shall provide a Project Foreman with a minimum of five (5) years documented experience in the supervision of roof system installation and shall be knowledgeable in the type of roof system specified herein.
- B. The Contractor shall not change the Foreman or crew without prior approval of the Engineer.
- C. The Contractor's Foreman shall be present on the job site during the majority of work hours and shall be accessible at all times to ensure good project coordination and communication.
- D. During the workday should the weather conditions appear to be changing adversely, the Foreman shall take preventative measures to allow the roof to be closed to a watertight condition to avoid exposure of buildings, equipment and materials.
- E. All Work that requires saw cutting, vacuuming and other similar functions that create substantial noise and/or vibration shall be coordinated well in advance of the work with the Owner and Engineer.
- F. Prior to the start of any roof project, and daily after the start, the Contractor shall review the type of space below the roof being worked on to ensure that all special requirements because of occupancy type are complied with prior to the start of the Work.
- G. Take all necessary precautions to protect the Owner's property as well as adjacent property, including trees, shrubs, buildings, sanitary and storm sewers, water piping, gas piping, electric conduit or cable, etc., from any and all damage which may result due to work on this Project.
- H. Repair any Work, damaged by failure to provide proper and adequate protection, to its original state to the satisfaction of the Owner or remove and replace with new Work at the Contractor's expense.

1.08 SUBMITTALS

- A. Submit shop drawings as required. Drawings shall show roof edge condition details, roof penetration flashing details, standard roof section and all other details required for proper roof system installation that are not shown in or that differ from the Specification and Drawings.
- B. Submit a list of materials for use in the Work.
- C. Submit product data for membrane and base flashing with temperature range for application of membrane.
- D. Submit membrane Manufacturer's installation instructions.
- E. A total of three (3) copies of each submittal is required.

1.09 PRODUCT DELIVERY, STORAGE AND HANDLING

- A. Deliver all materials in Manufacturer's original, unopened containers with Manufacturer's labels intact and legible.

SECTION 07531  
EPDM SHEET ROOFING - FULLY ADHERED

- B. Materials shall be stored so as to protect them completely from damage by the elements and temperatures. Storage of materials on ground and/or rooftop shall be protected with waterproof (canvas) covering and stored on raised platforms. The use of pallets or similar type equipment will be acceptable.
  - 1. Store cements, primers and Sealants between 40°F and 80°F. Should they be exposed to low temperatures, return to room temperature for several days prior to use.
  - 2. Waterproof (canvas) covering shall be applied in a watertight manner and securely tied at the end of each workday or work period.
  - 3. Use of Manufacturer's product protection wrapping is not acceptable for worksite type protection. The wrapping shall be side-punctured or end-punctured or slashed before covering with canvas.
  - 4. No tears in the waterproof (canvas) covering will be allowed.
- C. Material storage in warehouse, storage trailer or tent is recommended.
- D. Keep lids tightly sealed on all emulsions, solvent-based adhesives, and cements to keep volatiles from escaping.
- E. Stir adhesives thoroughly before using. Use mechanical methods of stirring; hand stirring with a paddle will not be acceptable.
- F. Single ply adhesives have a limited shelf life. The shelf life of the unused portion of material remaining in a previously opened container might be as low as overnight for some products. Remove all materials from the job site that are older than six months from the date of production.
- G. Altering the formulation of any adhesive by adding solvents is strictly prohibited. Any roofing installed using field-altered adhesives will be removed.

1.10 ENVIRONMENTAL REQUIREMENTS

- A. Do not apply roof membrane, or base flashings during inclement weather or when air temperature is below (or is expected to be below) 40°F (5°C).
- B. Do not start tear off of existing materials when inclement weather is expected.

1.11 GUARANTEES, WARRANTIES, CERTIFICATES

- A. Furnish two copies of the following to the Engineer:
  - 1. Contractor's Warranty: The Contractor shall warrant, in writing, that the roof system shall remain leak free for a period of five (5) years following completion and that the roof system has been installed according to material Manufacturer's current specifications. The warranty shall cover labor and materials. The MRCA printed guarantee shall be used as a standard.
  - 2. Membrane Manufacturer's Roof System Warranty: The roof system Manufacturer shall furnish an Original Cost of Installation of Manufacturer's Materials Roofing Guarantee. The guarantee

SECTION 07531  
EPDM SHEET ROOFING - FULLY ADHERED

shall include the costs of repairs or replacement of both the membrane and the insulation damaged as a result of the membrane failure and necessary to stop leaks which occur during a period of twenty (20) years from the date of completion, as a result of workmanship or deterioration of the membrane system or base flashing. The guarantee shall cover both labor and materials.

3. Membrane Manufacturer's Owner Service Manual: Provide for the Owner an informational manual to include Manufacturer's approved emergency repair procedures and materials, maintenance procedures and customer service information.

**PART 2 -- PRODUCTS**

The Contractor is responsible for furnishing the following materials in the amount required for completion of the entire Project specified herein.

2.01 ACCEPTABLE MANUFACTURERS

- A. Provide products by Manufacturers specified herein which meet or exceed standards as set forth in this Section. No materials specified or approved shall contain asbestos.
- B. All materials shall be new unless noted otherwise.

2.02 MATERIALS

- A. Membrane and Membrane Base Flashing: ASTM D4637 ethylene propylene diene monomer (EPDM), 0.060 inch thickness; in compliance with RMA RP-1 minimum requirements and a UL Class A fire rating, "RubberGard" by Firestone Building Products Company or approved equal.
- B. Miscellaneous Flashing: ASTM D4637 uncured EPDM elastomeric form flashing with pre-applied adhesive, 0.060" thickness, "EPDM Form Flash" by Firestone Building Products Company or approved equal.
- C. Tapes: Membrane splicing tape, such as "QuickSeam Splice Tape" by Firestone Building Products Company, or approved equal. Flashing tapes, such as "QuickSeam Flashing" and "QuickSeam Curb Flashing" by Firestone Building Products Company, or approved equal. Walk pads, such as "QuickSeam Walkway Pad" by Firestone Building Products Company, or approved equal.
- D. Cleaners, Primers, Adhesives, Sealants, and Other Accessory and Miscellaneous Component Materials: As required and recommended by the membrane Manufacturer to provide a complete watertight roofing system and as required by the membrane Manufacturer to provide the Owner with the warranty as specified.
- E. Walk Pads to be installed as shown on the roof plan shall be fully adhered QuickSeam Walks Pads as manufactured by Firestone Building Products or approved equal.
- F. Fasteners (Miscellaneous):
  1. Fasteners such as nails, screws, bolts, etc. shall be compatible with the roof membrane and flashing system. They shall be of type and size as shown on the Drawings, recommended by the roof membrane Manufacturer or specified herein.

SECTION 07531  
EPDM SHEET ROOFING - FULLY ADHERED

2. Screws used to secure metal to blocking shall be No. 8 minimum, galvanized penetrating wood blocking a minimum 1-1/2" and shall have watertight neoprene washers under head. The installed withdrawal resistance shall be a minimum of 150 pounds per screw.
  3. Nails used to secure wood such as fascias, cant strips, blocking and nailers to other wood members shall be galvanized and long enough to penetrate 1-1/4". Two rows are required, staggered when feasible. Spacing in any one row shall not exceed 24". Spacing shall not exceed 12", 8' each way from outside corners. Withdrawal resistance shall be 100 pounds per nail minimum. (Lag screws of equivalent strength may be used if desired.)
  4. Fasteners used to secure lumber to masonry or concrete shall be 1/2" minimum diameter metal expansion stud anchors in pre-drilled holes such as Kwik-Bolt II Stud Expansion Anchor by Hilti, Inc. or approved equal. Space fasteners at 12" o.c. (maximum).
  5. Fasteners used to secure metal to metal shall be hardened, self-tapping, sheet metal gimlet point type, with hex/washer head and be of compatible material.
  6. Other fasteners not specifically described shall be as selected by the Contractor subject to approval by the Engineer. All fasteners shall meet the requirements set forth in FM Data Sheets 1-28 and 1-49 as appropriate.
- F. Roof Drain Assemblies: Obtain replacement clamps, rings and strainers from original Manufacturer if possible. All strainers shall be cast iron.
- G. Lumber, Nailers and Blocking: #2 grade wood (lumber) or better with salt preservative pressure treatment (0.40 pcf minimum retention).
- H. Plywood: 3/4" APA exterior rated 4-ply CDX (0.40 pcf minimum retention).
- I. Polyvinyl Chloride (PVC) Piping: Conforming to requirements for Schedule 40, DWV pattern, ASTM D1785 and D2665.
- J. EPDM Boot Flashing: Pre-molded round EPDM penetration flashing conforming to Rubber Manufacturers Association (RMA) minimum specifications "Pipe Boot" by Firestone Building Products Company or approved equal.
- K. Other Materials: All other materials, not specifically described but required for a complete and proper installation of the work in this Section shall be as selected by the Contractor subject to approval by the Engineer.

**PART 3 -- EXECUTION**

**3.01 DEFINITIONS**

- A. Bond: The adhesive and cohesive forces holding two roofing components in intimate contact.
- B. The term "phased construction" or "phased application" shall mean the roofing system construction or application process in which all parts of cross-section of a roofing system (including vapor retarder), roof insulation, roof membrane and surfacing are not completed for a particular roof area during one day or work period.

SECTION 07531  
EPDM SHEET ROOFING - FULLY ADHERED

3.02 EXAMINATION

- A. The Contractor shall have the sole responsibility for the accuracy of all measurements and for the estimate of material quantities required and necessary to satisfy the requirements of these Specifications.

3.03 WORKMANSHIP

- A. All roofing work shall be accomplished with a non-working Foreman overseeing the work of the felt setters, mop men, felt layer operators and kettle men who are thoroughly skilled in the application of specified materials. All workmanship to be of the very best and shall be done in such a manner as to fulfill the requirements of the Drawings and Specifications.
- B. Weather Condition Limitations: Proceed with roofing work only when existing and forecasted weather conditions will permit work to be performed in accordance with the requirements of this Specification.
- C. After starting the Work, the Contractor shall be responsible for complete moisture integrity of the roofing and flashing membrane and for providing a properly applied roof. Therefore, the Contractor shall:
1. Establish and follow application procedures to insure that adequate quantities of materials are used.
  2. Maintain competent Foreman continuously supervising the Work, with authority to discard unsuitable materials and remove unsatisfactory workmen from the Project.
  3. Observe all fire precautions involving the storage and handling of roofing materials. Provide adequate quantity of fire extinguishers at worksite, especially at the kettles, torches or open flames.
  4. Comply with current roofing safety standards at all times.
  5. Supervise installation of and be responsible for seeing that roof mechanical and electrical equipment, roof drains, etc. are properly set without damage to the roof. Make roof and flashing repairs as necessary and advise the Engineer in writing of all potential leaks as may be caused by other trades not under the Contractor's control.
  6. Under no conditions shall any roofing materials be applied before sunrise, or at anytime when there are indications of moisture present (rain, mist, dew, frost, and snow).
  7. Install only as much roofing material as can be completed and covered in accordance with the requirements of this Specification in any one day or work period.
  8. All seams shall be a minimum 6" wide. The adhesive tape shall be installed in strict accordance with the Manufacturer's directions.
  9. Apply roof membrane so that the direction of water flow is over, and not against the laps. Closely follow the Manufacturer's requirements for adhesive tape and sealant application.
  10. Insure that all wheeled equipment on the roof be equipped with pneumatic tires.

SECTION 07531  
EPDM SHEET ROOFING - FULLY ADHERED

11. Permit no traffic over, not stack roofing equipment or materials on completed new roof surfaces without adequate protection with 1/2" plywood.
  12. Insure that all fishmouths are cut (do not attempt to walk down) and objects causing separation between reinforcing plies are removed. Patch the areas if the cut is made after the interply mopping has set up.
  13. The Contractor shall install flashing at openings, projections and walls adjoining new roofing every day or work period. If circumstances do not allow this, these areas shall be made watertight at the end of each day or work period.
  14. At the end of each day's Work, install temporary water cut-offs at all points where the roof membrane does not abut a wall, wood edge member or expansion joint. The water cut-off shall be removed completely before continuing the roof installation. If breaks occur in the water cut-offs or any other part of the roof membrane and water damages the roof insulation, all damaged roof insulation, vapor retarder and roof membrane over the damaged insulation shall be removed and replaced with new materials.
  15. Comply with other workmanship requirements as outlined in other Sections of this Specification.
- D. The following cold weather (below 40°F) precautions shall be followed when applying the modified asphalt roof system to insure proper performance of this Specification.
1. Let the membrane "relax" longer and only work on sunny days.
  2. Keep the adhesive tape warm so that it can be properly applied. Do not apply a load to a field seam for several days as the cure and strength of the adhesive tape joint take longer to develop in cold weather.
  3. Allow adequate time for the solvents in the adhesives to "flash off", so the seams will be strong. Check the "dryness" of the apply adhesives carefully before sealing the joints.

3.03 HEALTH AND SAFETY PRECAUTIONS

- A. Single ply roofing adhesives, cements and sealants contain ingredients, which can be toxic and are extremely flammable. Ensure that vapors are not allowed to enter the building at air intake vents or other points of access. Absolutely no smoking is allowed on the entire roof for the duration of the Project.

3.04 ROOF MEMBRANE INSTALLATION

- A. Roll roof sheets out over prepared substrate and allow membrane to relax for a minimum of 30 minutes.
- B. Fully adhere membrane to insulation per Manufacturer's detailed instructions.
- C. Eliminate air bubbles, wrinkles and fishmouths.
- D. Clean membrane lap seams (joints) to remove dirt and talc from the lap area.



SECTION 07531  
EPDM SHEET ROOFING - FULLY ADHERED

- E. Apply adhesive tape to membrane lap seams in strict accordance with the Manufacturer's directions.
- F. Check all seams with a probe. Ensure that roof sheets are fully bonded.
- G. Cover seam area with 6 inch batten cover.

3.05 BASE FLASHING INSTALLATION

- A. Install new wood blocking and metal where required and as specified in other sections of this Specification.
- B. All rooftop equipment (including plumbing vents, base flashings, exhaust fans, skylights, vents, etc.) shall be raised by installing Contractor with specified and/or approved material to provide minimum of 8" between surface membrane and top of base flashing.
- C. Install base flashing according to the Drawings and roof membrane Manufacturer's requirements.
- D. Extend plumbing vents as necessary to assure a minimum of 8" of flashing height as measured from surface membrane to top of vent stack. Furnish and install PVC piping with EPDM couplers as required.
- E. Prime all sheet metal that is to be stripped into the roof membrane as required. Allow primer to dry before stripping in.
- F. Comply with applicable recommendations of Factory Mutual Prevention Data 1-49.
- G. All flashing on section being re-roofed shall be completed or made watertight by the end of the working day.

3.06 MISCELLANEOUS DETAILS

- A. Roof Drains
  - 1. Disassemble and remove domes and clamping collars. Clean and examine sumps and drain components. Replace all missing or broken components. Install new clamps and bolts.
  - 2. Install and seal roof membrane and flashings at drains according to the Drawings.
  - 3. All roof drain systems shall be installed to allow positive water flow into the roof drain from the roof surface.
  - 4. Replace strainers in drains at the end of the working day.

--- END OF SECTION ---

## SECTION 07620

### SHEET METAL FLASHING AND TRIM

#### **PART 1 -- GENERAL**

##### 1.01 CONDITIONS OF THE CONTRACT

- A. The Conditions of the Contract (General, Supplementary and Other Conditions) and the requirements of Division 1 are hereby made a part of this Section. Applicable provisions of Division 1 shall govern Work under this Section.

##### 1.02 WORK INCLUDED

- A. This Section includes all labor, material, equipment and related services necessary to furnish and install the following Work.
  - 1. Sheet metal coping.
  - 2. Sheet metal trim.
  - 3. Sheet metal counterflashing and receivers.
  - 4. Sheet metal scupper inserts.
  - 5. Sheet metal sheet metal wall panel assembly.
  - 6. Sheet metal expansion joint cover assembly.
  - 7. Miscellaneous sheet metal and accessories associated with roofing.

##### 1.03 RELATED SECTIONS

- A. Section 02070 - Demolition.
- B. Section 07201 - Insulation.
- C. Section 07531 – Elastomeric Sheet Roofing-Fully Adhered
- D. Section 07620 - Sheet Metal Flashing and Trim
- E. Section 07900 - Sealants.

##### 1.04 QUALITY ASSURANCE

- A. Perform flashing and sheet metal work in coordination with installer performing roofing.
- B. There shall be no deviation made from this Specification or the approved shop drawing without prior written approval by the Manufacturer and Engineer.
- C. Shop drawings of proposed alternate details shall be submitted to Engineer for approval prior to

start of construction.

- D. Proposed alternate details and application procedures shall comply with the Specifications, Drawings and Manufacturer's recommendations.

#### 1.05 REFERENCES

- A. References shall refer to the most recent standard.
  - 1. American Society for Testing and Materials (ASTM).
  - 2. Federal Specification (FS).
  - 3. Sheet Metal and Air Conditioning Contractor's National Association (SMACNA).

#### 1.06 SPECIAL CONTRACTOR REQUIREMENTS

- A. The Contractor shall provide a Project Foreman with a minimum of five (5) years documented experience in the supervision of sheet metal installation and shall be knowledgeable in the type of work specified herein.
- B. The Contractor shall not change Foreman or crew without prior approval of the Engineer.
- C. The Contractor's Foreman shall be present on the job site during the majority of the Work hours and shall be accessible at all times to ensure good Project coordination and communication.
- D. All Work that requires saw cutting, vacuuming and other similar functions that create substantial noise and/or vibration shall be coordinated well in advance of the Work with the Owner and Engineer.
- E. Prior to the start of any project and daily after the start, the Contractor shall review the type of space below the roof being worked on to ensure that all special requirements because of occupancy type are complied with prior to the start of the Work.
- F. Take all necessary precautions to protect the Owner's property as well as adjacent property, including trees, shrubs, buildings, sanitary and storm sewers, water piping, gas piping, electric conduit or cable, etc. from any and all damage which may result due to Work on this Project.
- G. Repair any Work, damaged by failure to provide proper and adequate protection, to its original state to the satisfaction of the Owner or remove and replace with new Work at the Contractor's expense.

#### 1.07 SUBMITTALS

- A. Submit shop drawings as required. Drawings shall show all details required for proper roof system installation that are not shown in or that differ from the Specifications and Drawings. Submit shop drawings clearly detailing shaping, joining, length of sections, fastening and installation details.
- B. Submit a list of materials for use in the Work.
- C. Submit standard color samples for approval.

- D. Submit shop drawing and sample of coping.
- E. Submit shop drawing and sample of counterflashing and receiver.
- F. Submit shop drawing of sheet metal expansion joint cover assembly.
- G. One e-mail copy of each submittal drawing is required.

#### 1.08 PRODUCT DELIVERY, STORAGE AND HANDLING

##### A. Delivery and Storage of Materials

1. Deliver all materials in their original unopened containers with all markings intact.
2. Store all materials in a dry place or otherwise protect from water or extreme humidity.
3. Stack metal at least 4" above the ground on pallets and cover with a breathable covering, such as canvas. Covering shall extend to grade on all sides.
4. Store cements, adhesives and sealants in the manner and temperature range recommended by the individual Manufacturers.
5. Remove damaged materials from the site and replace with new.

##### B. Handling Materials

1. Handle metal sections to avoid bending, breaking or otherwise damaging them during transportation and installation.
2. Do not store or transport materials on the roof in a manner that may exceed the live load capacity of the deck system or the structure. The Engineer, during routine inspections, may make recommendations as to loading.
3. Do not transport materials over or store materials on a finished section without prior approval of the Engineer.

#### 1.09 GUARANTEES, WARRANTIES, CERTIFICATES

##### A. Furnish two copies of the following to the Engineer:

1. Contractor's Warranty: The Contractor shall warrant, in writing the workmanship for a period of five (5) years following completion and that the Work has been installed according to material Manufacturer's current specifications. The warranty shall cover labor and materials.
2. Manufacturer's Warranty: Provide Manufacturer's standard warranty guaranteeing color, fade, chalking and film integrity for a period of 20 years when tested against the Weatherometer Method 6152, acceptable per FED TEST METHOD 141 for pre-finished metals with resin coating.

## **PART 2 -- PRODUCTS**

The Contractor is responsible for furnishing the following materials in the amount required for completion of the entire Project specified herein.

### **2.01 ACCEPTABLE MANUFACTURERS AND MATERIALS**

- A. Provide products by Manufacturers specified herein which meet or exceed standards as set forth in this Section.
- B. All materials shall be new unless noted otherwise.

### **2.02 MATERIALS**

- A. Coping, Expansion Joint Cover Assembly, Parapet Wall Metal and Counterflashing: 24 gage factory painted galvanized steel with "Kynar 500" coating. "UNA-CLAD" as manufactured by Firestone Building Products or approved equal. Submit color to Owner and Engineer for approval.
- B. Miscellaneous Sheet Metal: Galvanized steel, ASTM A525 Class G-90 zinc coating, 24 gage with minimum 1.25 oz. per square foot galvanized coating.
- C. Sheet Metal Wall Panel: 24 gauge factory painted galvanized steel with Kynar 500 resin coating meeting ASTM D-2244. Vertical exposed fastener Omega VR Classic as manufactured by Firestone Building Products or approved equal. Submit color for approval.
- D. Continuous Cleat: 20 gage galvanized steel with minimum 1.25 oz. per square foot galvanized coating.
- E. Scupper Insert: Nominal 6" (H) X 9" (L) .018" stainless steel with 2D finish.
- F. Fasteners (Miscellaneous)
  - 1. Fasteners such as nails, screws, etc. shall be of same material as metal flashing on which they are used. They shall be of type and size as shown on the Drawings or specified herein.
  - 2. Screws used to secure metal to blocking shall be #8 minimum, penetrate wood blocking minimum 1-1/2" and shall have metal washers and watertight neoprene washers under hex head. The installed withdrawal resistance shall be a minimum of 150 pounds per screw.
  - 3. Fasteners used to secure metal to metal shall be hardened, self-tapping, sheet metal gimlet point type, with hex/washer head and be of compatible material.
  - 4. Fasteners used to secure sheet metal to masonry or stone shall be 1/4" minimum diameter metal expansion stud anchors in pre-drilled holes such as "Kwik-Bolt II Stud Expansion Anchor" by Hilti, Inc. or approved equal. Space fasteners at 24" o.c. maximum spacing.
  - 5. Fasteners used to secure gutter spacers to hemmed edge shall be 3/8" diameter cadmium plated nut, bolt and washer assemblies.

- G. Solder: FS QQ-S-571 or ASTM B32. Use 50/50 for all applicable work unless otherwise specified.
- H. Soldering Flux: FS O-F-506, type best suited for specific material.
- I. Other Materials: All other materials not specifically described but required for a complete and proper installation of the Work in this Section, shall be as selected by the Contractor subject to the approval by the Engineer.

### 2.03 FABRICATION

- A. Form sections square, true and accurate to size, free from distortion and other defects detrimental to appearance or performance.
- B. Provide cross-break to top surface of coping metal and at all exposed surfaces of all metals which exceed 8" in cross dimension.

## **PART 3 -- EXECUTION**

### 3.01 EXAMINATION

- A. Examine supporting members and substrate for layout, alignment and soundness.
- B. Verify that surfaces are free from debris and unnecessary protrusions.

### 3.02 INSTALLATION

- A. Counterflashing
  1. Saw-cut mortar joints to form new reglet 1" minimum uniform depth at elevation of a minimum 10" above the surface of the roof membrane, as shown on the Drawings. New reglet joint shall not interfere with the location or performance of any through wall flashing.
  2. Secure spring locked reglet receivers in clean and sound saw cuts at mortar joint.
  3. The reglet receiver shall be notched and lapped at all corners and joints.
  4. Secure flashings to reglet receivers using specified type fasteners at 18" o.c. maximum.
  5. Fit flashing tight in place. Make corners square, surfaces true and straight in planes, and lines accurate to profiles.
  6. The counterflashing shall be notched and lapped at inside corners and joints and seamed at outside corners.
  7. Maintain lines of constant elevation around entire perimeter unless noted otherwise on the Drawings.
  8. Apply continuous bead of sealant to masonry/metal intersection at top of reglet. Tool to smooth finish.

9. Where existing structural expansion joint intersects sheet metal work, provide “slip joint” in sheet metal work to accommodate movement of the structure.

B. Coping

1. Install loose laid EPDM cap flashing over parapet as shown on the Drawings and bond at all laps and seams.
2. Install continuous cleat at location(s) as shown on the Drawings.
3. Coping section lengths shall be contained to 10’ lengths or less. Secure each length at 2’ centers through oversized slotted holes on the roof side of the section.
4. Maintain lines of constant elevation around entire perimeter.
5. Where existing structural expansion joint intersects sheet metal work provide “slip joint” in sheet metal work to accommodate movement of the structure.

C. Scuppers

1. Lock seams and end joints. Fit flashing tight in place. Make corners square, surfaces true and straight in planes, and lines accurate to profiles. Hem all exposed edges.
2. Solder seams at all vertical and horizontal surfaces.
3. Insert into joints to form tight fit. Secure in place with specified type fasteners.
4. Seal joints around scupper edge with continuous 5/8” bead of sealant, then tool.

D. Sheet Metal Expansion Joint Cover Assembly

1. Where existing structural expansion joint intersects sheet metal work provide “slip joint” in sheet metal work to accommodate movement of the structure.

--- END OF SECTION ---

## SECTION 07900

### SEALANTS

#### **PART 1 -- GENERAL**

##### 1.01 CONDITIONS OF THE CONTRACT

- A. The Conditions of the Contract (General, Supplementary and Other Conditions) and the requirements of Division 1 are hereby made a part of this Section. Applicable provisions of Division 1 shall govern Work under this Section.

##### 1.02 WORK INCLUDED

- A. This Section includes all labor, materials and equipment necessary to perform the following Work:
  - 1. Removal of all existing caulking/sealant to be replaced.
  - 2. Preparation of all surfaces to receive new sealant work.
  - 3. Application of the joint waterproofing sealant.
  - 4. Clean up.

##### 1.03 RELATED SECTIONS

- A. Section 02070 - Demolition.
- B. Section 06010 – General Carpentry.
- C. Section 07201 - Insulation.
- D. Section 07531 – Elastomeric Sheet Roofing-Fully Adhered
- E. Section 07620 - Sheet Metal Flashing and Trim

##### 1.04 QUALITY ASSURANCE

- A. The Manufacturer of the sealant system shall have a minimum of five (5) years experience in the manufacture of waterproof coatings and sealants.

##### 1.05 SUBMITTALS

- A. Manufacturer's Literature: Submit two (2) complete sets of Manufacturer's literature and technical data for the sealant system.
- B. Contractor's Certificate: Submit copies of "Licensed Applicator's Certificate" issued by the Manufacturer.
- C. One e-mail copy of each submittal is required.

##### 1.06 PRODUCT DELIVERY, HANDLING AND STORAGE



A. Delivery and Storage of Materials

1. Deliver all materials in their original unopened containers with all markings intact.
2. All materials must be stored in a dry place or otherwise protected from water or extreme humidity.
3. Stack material on pallets at least 4" above the ground and cover with a breathable covering, such as canvas.
4. Store sealants in the manner and temperature range recommended by the Manufacturer.

B. Handling Materials

1. Do not store or transport materials on the roof in a manner that may exceed the live load capacity of the deck system or the structure. The Engineer, during routine inspections, may make recommendations as to loading.
2. Do not transport materials over or store materials on a finished section without prior approval of Engineer.

#### 1.07 ENVIRONMENTAL REQUIREMENTS

- A. The Contractor shall follow the sealant Manufacturer's recommendations with regard to surface preparation and to the various moisture and temperature limitations of the materials.
- B. Install the sealant material under conditions where rain is not anticipated within eight hours of application and substrate surface temperatures are above 40°F and below 110°F.

#### 1.08 GUARANTEES, WARRANTIES, CERTIFICATES

- A. The sealant Manufacturer and the Contractor shall warrant the performance of the coating system for a period of five (5) years starting from the date of acceptance by the Engineer. Such warranty shall include material as well as labor for application. Damage and/or failure due to acts of God and vandalism, may be excluded from such warranty.

### **PART 2 -- PRODUCTS**

The Contractor is responsible for furnishing the following materials in the amount required for completion of the entire Project specified herein.

#### 2.01 ACCEPTABLE MANUFACTURERS

- A. Components of the materials as specified herein shall be products of a single approved Manufacturer or shall be approved by the Manufacturer as compatible with components produced by him and that such components shall be permissible for use under the terms of the warranty.
- B. Provide products by Manufacturers specified herein which meet or exceed standards as set forth in

this Section. No material specified or approved shall contain asbestos.

## 2.02 MATERIALS

- A. Sealant: A hybrid multi-component chemically curing polyurethane joint sealant meeting the requirements of ASTM C920 Type M, Grade P, Class 25 Standards. Sealant material shall be polyurethane elastomer based, meeting or exceeding minimum physical properties as listed in Section 2.03, and capable of producing a seamless waterproof joint seal. Color shall be chosen to most closely match that of the adjacent concrete/masonry. **OR** non-staining and no-tack, soft type with high elongation properties and shall be so designated on the label by the Manufacturer such as “Sikaflex 1a” by SIKA Corp., “Sikaflex 2c NS/SL” by SIKA Corp., “Sonolastic NP1” by Sonneborn Building Products, or “Dimonic” by Tremco, Inc. Follow all Manufacturers’ previously submitted recommendations for type required at joints. Use non-sag at all joints.
- B. Joint Cleaning Compound: As recommended by the sealant Manufacturer for the joint surfaces to be cleaned.
- C. Joint Primer/Sealer: As recommended by the sealant Manufacturer for the joint surface to be primed or sealed.
- D. Bond Breaker Tape: Polyethylene tape or other plastic tape as recommended by the sealant Manufacturer to be applied to sealant-contact surfaces where bond to the substrate or joint filler must be avoided for proper performance of sealant. Provide self-adhesive tape where applicable.
- E. Sealant Backer Rod: Compressible rod stock polyethylene foam, polyethylene jacketed and polyurethane foam or other flexible, permanent, durable non-absorptive material as recommended for the compatibility with sealant by the sealant Manufacturer; which will control the joint depth for sealant placement, break bond of sealant at bottom of joint, form optimum shape of sealant bead on back side, and provide a highly compressible backer to minimize the possibility of sealant extrusion when the joint is compressed. Backer rod shall be at least 1/2” larger than the width of the joint.
- F. Pitch Pan Sealant: Two-part, self-leveling, Type 1, LP liquid polysulfide polymer sealant such as “LP Polysulfide Base Sealant” by Morton Thiokol, Inc. or approved equal.
- G. Pitch Pan Grout: Non-shrink epoxy grout conforming to ASTM C827 such as “Five Star Epoxy Grout” by U. S. Grout Corporation or approved equal.

## 2.03 TYPICAL PERFORMANCE CHARACTERISTICS

- A. T-S-00227E and 19-GP-24 test method:

Adhesion-In-Peel	Mortar 6.3 kg (14 lbs) Anodized aluminum 8.2 kg (18 lbs) Granite 7.3 kg (16 lbs) Minimum requirement 2.26 kg (5 lbs)
Durability (Bond and Cohesion)	Passed (on mortar, granite and anodized aluminum at ± 25% movement)
Sagging	None up to 50°C (122°F)

Hardness	25 (Shore A) after 7 days at 24°C (75°F), plus 21 days at 70°C (158°F)
Percent Solids	96% after 7 days at 24°C (75°F), plus 21 days at 70°C (158°F)
Pot Life	Up to 7 hours at 24°C (75°F)
Tack-Free Time	Less than 72 hours at 24°C (75°F)
Low Temperature Flexibility	-54°C (-65°F)
Staining	None

**B. Other Test Methods**

Hardness (ASTM D2240)	Average 35 (Shore A) after 5 years
Extension and Compression and Cycle TRC-ST/450	1/2" X 1/2" (12 mm X 12 mm) at 24°C (75°F) will withstand 100 cycles of 40% extension and 25% compression
Ultra-Violet Resistance TRC-ST/448	No adverse effects after 5 weeks' exposure to 14-25 E-Viton of UV energy at 70°C (158°F)
Accelerated Aging ASTM E42, Method E	No adhesive or cohesive failure, nor significant changes at 8,000 hours

**PART 3 -- EXECUTION**

**3.01 EXAMINATION**

- A. The Contractor shall have the sole responsibility for the accuracy of all measurements and for the estimate of material quantities required and necessary to satisfy the requirements of these Specifications.

**3.02 SEQUENCING/SCHEDULING**

- A. Remove only as much Work as can be restored to a weather tight condition each day or before showers commence.
- B. All Work shall be completed each day on the section being worked on.
- C. The Contractor shall not proceed with the Work until all unsatisfactory conditions detrimental to the proper and timely completion of the Work have been corrected.

### 3.03 SUBSTRATE PREPARATION

- A. Remove all debris from working surfaces. Remove all loose materials including spalling concrete and old epoxy patches.
- B. Thoroughly clean all surface areas involved to remove dirt, oils, grease, heavy laitance, for release agent, curing compound, and other contaminants, which would interfere with the application and performance of the sealant, in accordance with the Manufacturer's recommendations.
- C. Remove all foreign projections in the joint by grinding or other suitable methods.

### 3.04 SEALANT APPLICATION

- A. All material shall be applied in strict accordance with the Manufacturer's recommendations.
- B. All surfaces to receive the sealant system shall be air-dried a minimum of 24 hours immediately prior to performing Work.
- C. Where Manufacturer's specifications are more stringent or require more material than specified herein, follow the Manufacturer's specifications.
- E. Joint Backing
  - 1. Joint backing shall be used to control the depth of joint to the recommended dimension.
  - 2. Select a size, to allow for 25% minimum compression of the backing when inserted into the joint.
  - 3. Where depth of joint will not permit use of joint backing, a bond-breaker tape must be installed to prevent three-sided adhesion.
- F. Sealant
  - 1. Mix according to Manufacturer's detailed instructions.
  - 2. Minimum mixing time: 6 minutes.
  - 3. Apply with conventional sealant equipment, filling joint completely.
- G. Tooling
  - 1. Immediately after application, tooling shall be employed to insure firm, full contact with the inner faces of the joint.
  - 2. Dry tooling is preferred. Tooling agents can be used.
- H. Pitch Pans

1. Fill pitch pans with non-shrink grout to a maximum depth of 3/4" below top of pan.
2. Install pourable, self-leveling sealant flush with top of pitch pan.

I. Cleaning

1. Remove immediately all excess sealant adjacent to the joint with "Xylol" or "Toluol" as work progresses.
2. Avoid staining of adjacent areas.
3. At the conclusion of the sealant Work, remove all tools, scaffolding, equipment, construction materials and construction debris from the site.

--- END OF SECTION ---

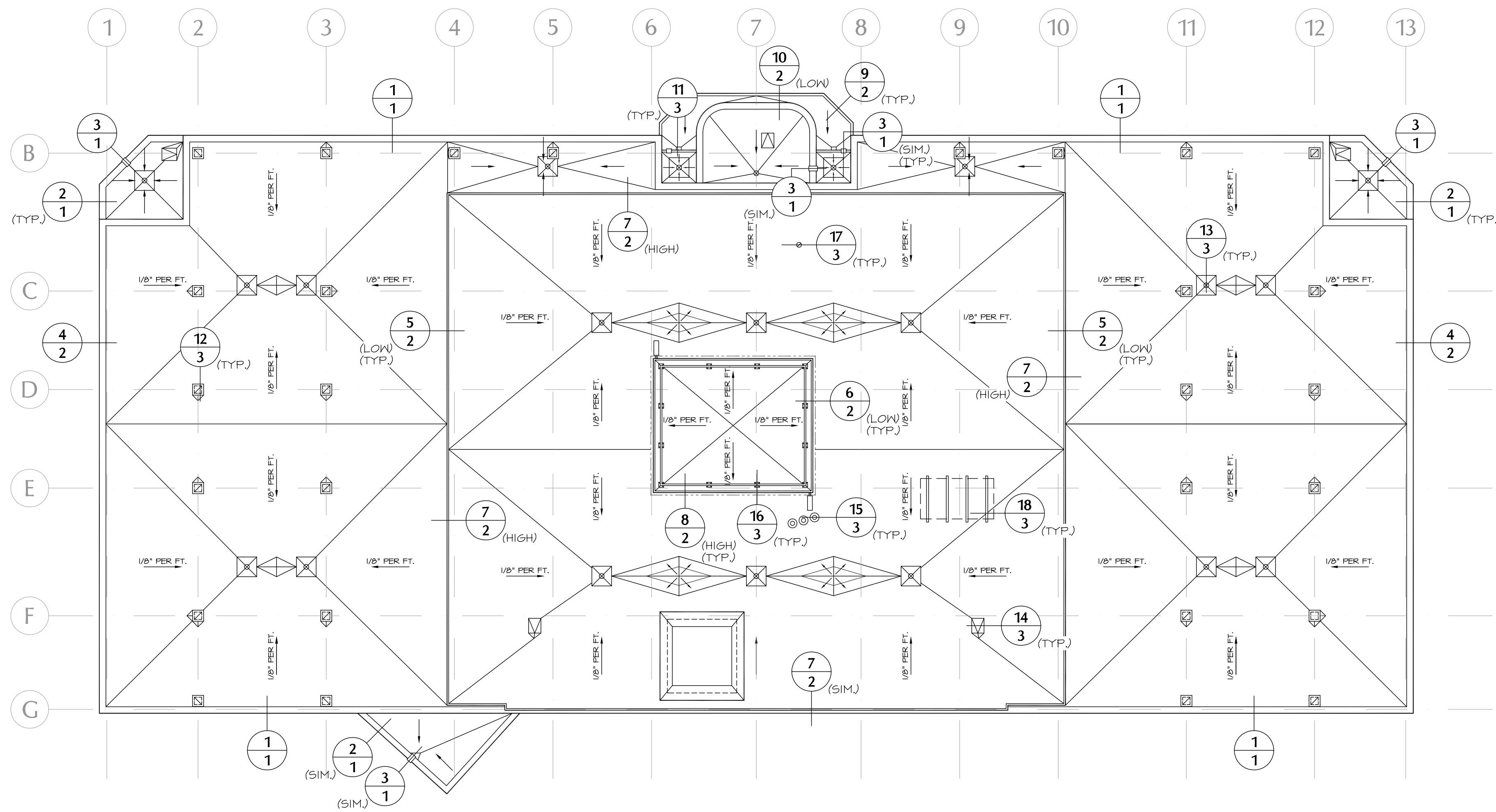

**ROOF PLAN**  
SCALE: 1/16"=1'-0"

- GENERAL NOTES:**
- CONTRACTOR IS RESPONSIBLE FOR THE VERIFICATION OF ALL DIMENSIONS AND EXISTING DETAILS AND CONDITIONS PRIOR TO SUBMITTING BID AND STARTING WORK.
  - DETAILS SHOWN REPRESENT EXISTING CONDITIONS TO THE EXTENT KNOWN, WITH THE NEW MATERIALS AND/OR PROCEDURES CALLED OUT.
  - CONTINUOUS EPDM SHEETS, WHEREVER SPECIFIED, SHALL BE BONDED AT ALL LAPS.
  - INSULATION SHALL BE TAPERED TO DRAIN OPENINGS, ON ALL SIDES FROM ITS CLAMPING RING.
  - CONTRACTOR SHALL COORDINATE ALL GAS LINE DISCONNECT AND RECONNECT, PROVIDE NEW GAS LINE SUPPORTS AS REQUIRED W/ MODIFIED SLIP SHEETS AND SHALL VERIFY THAT ALL GAS LINE JOINTS ARE SOUND AT THE END OF CONSTRUCTION.
- DESIGN NOTES:**
- EXISTING ROOF SYSTEM: BALLASTED EPDM ROOF MEMBRANE, 1/2" WOOD FIBERBOARD INSULATION, 1/8" PER FT. TAPERED POLYISOCYANURATE INSULATION, CONCRETE DECK (VARIOUS TYPES).

- LEGEND:**
- ROOF DRAIN W/ SUMP
  - OVERFLOW SCUPPER
  - SKYLIGHT RAILS
  - PLUMBING VENT
  - COLUMN CAP
  - SMOKE HATCH
  - GOOSENECK VENT
  - RAILING SUPPORT
  - GUTTER
  - STRUCTURAL SLOPE
  - DESIGN NOTE

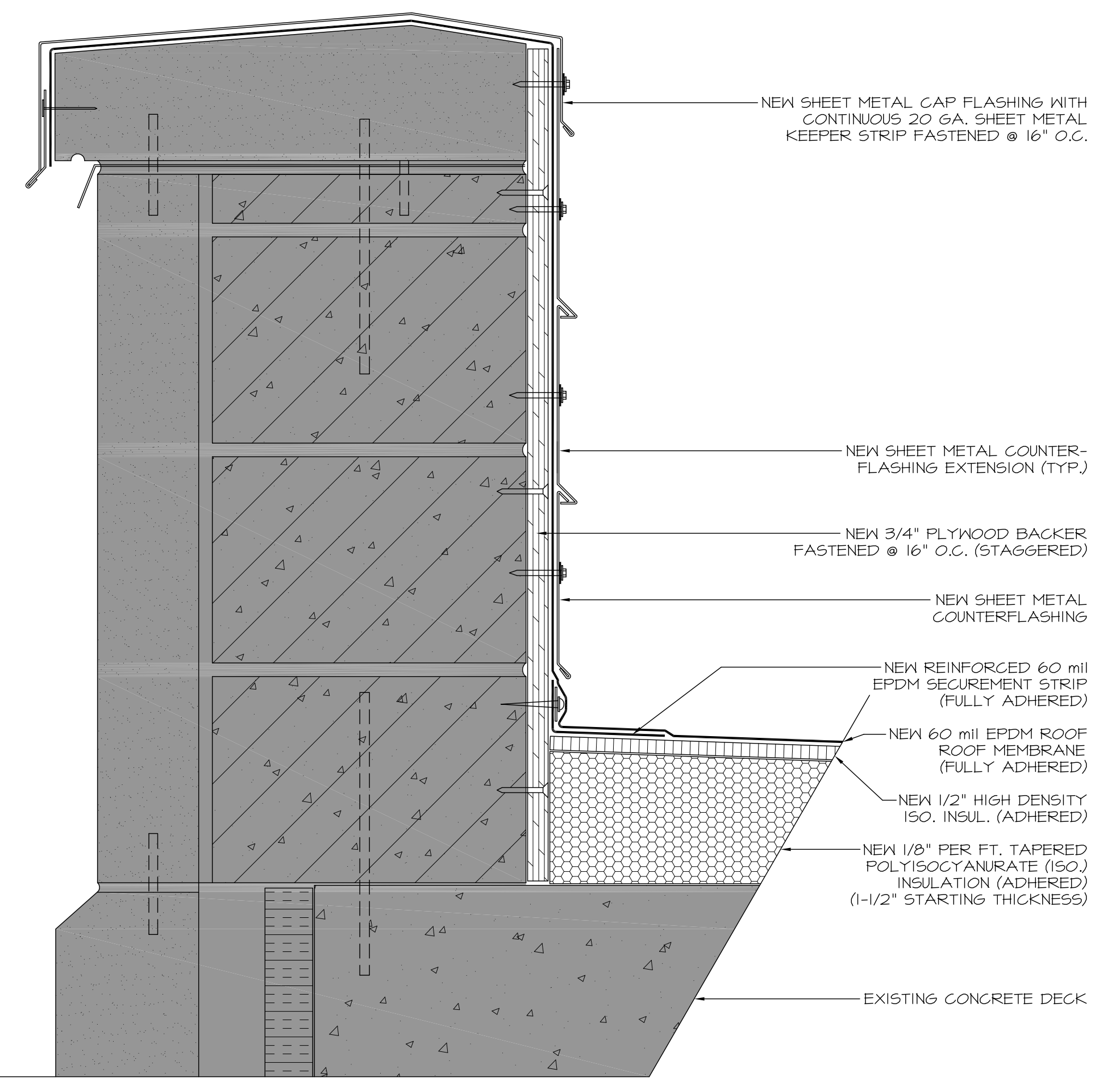
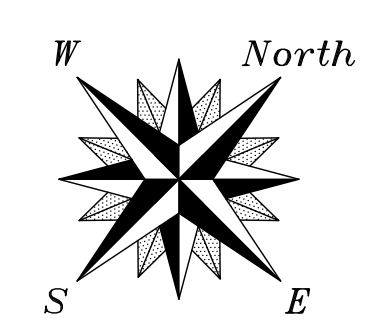

**1**  
**1** PARAPET FLASHING DETAIL  
SCALE: 3"=1'-0"

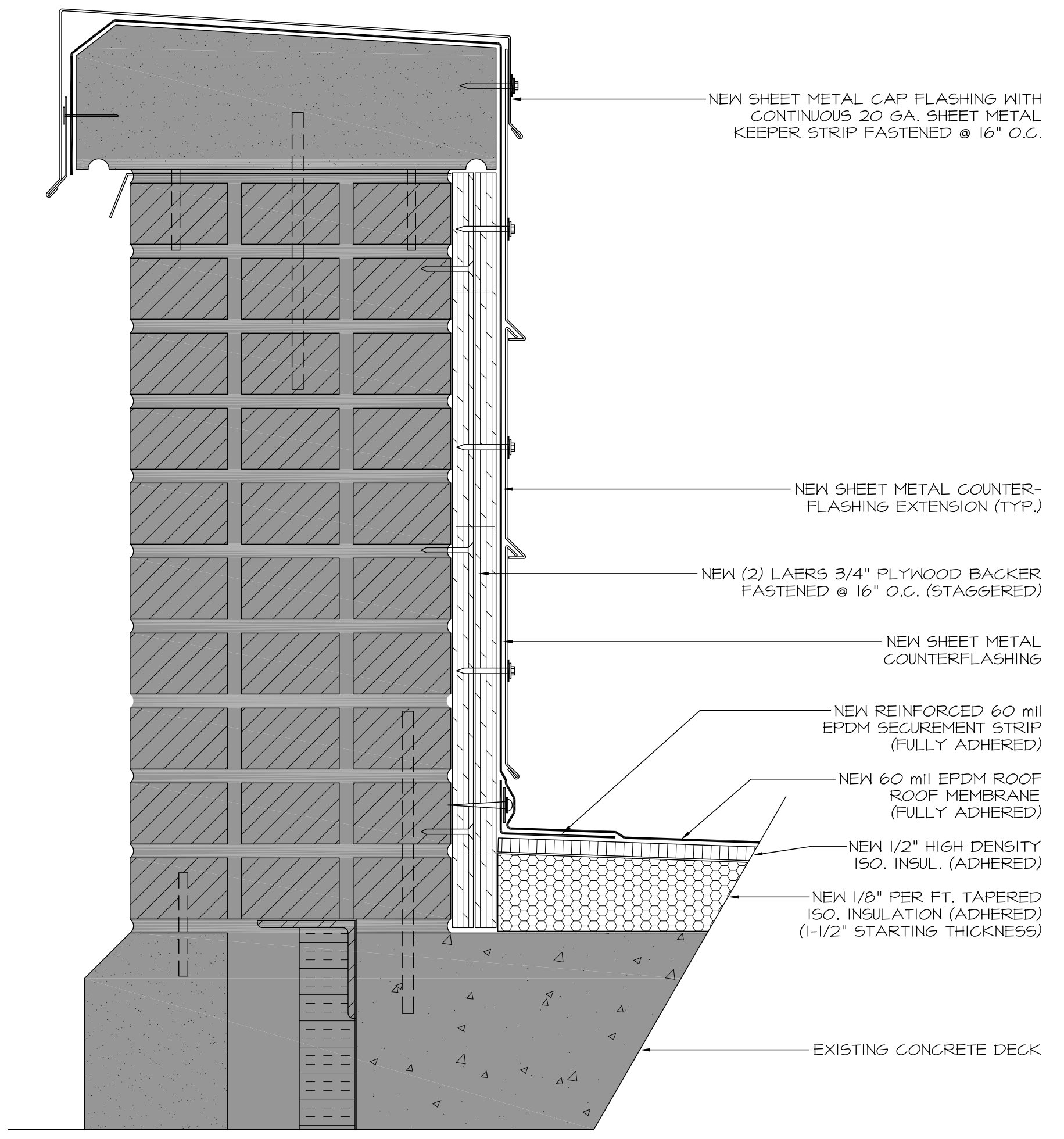

**2**  
**1** PARAPET FLASHING DETAIL  
SCALE: 3"=1'-0"

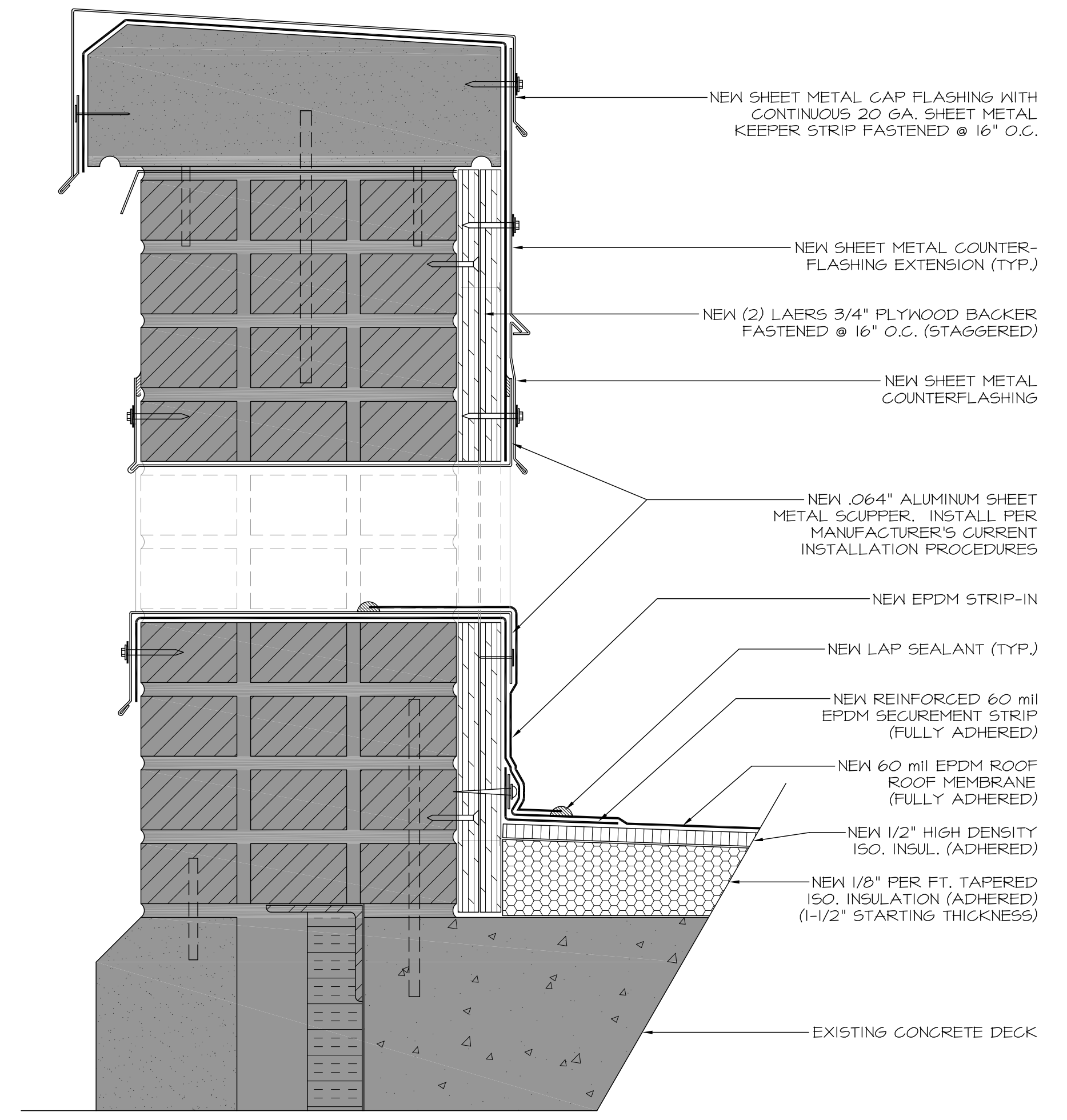

**3**  
**1** OVERFLOW SCUPPER DETAIL  
SCALE: 3"=1'-0"

PROJECT # 15143.00  
SHEET: 1 OF 3

3207 Laura Lane  
Middleton, WI 53562  
608-651-9535

SRI Consultants, Inc.

DATE: 06-19-19  
DESIGNED BY: T. COLLITON  
CHECKED BY: SRI CONSULTANTS, INC.  
REVISED BY:

**PUBLIC SAFETY BUILDING**  
115 WEST DOTY STREET  
MADISON, WISCONSIN  
2019 ROOF REHABILITATION

FOR:

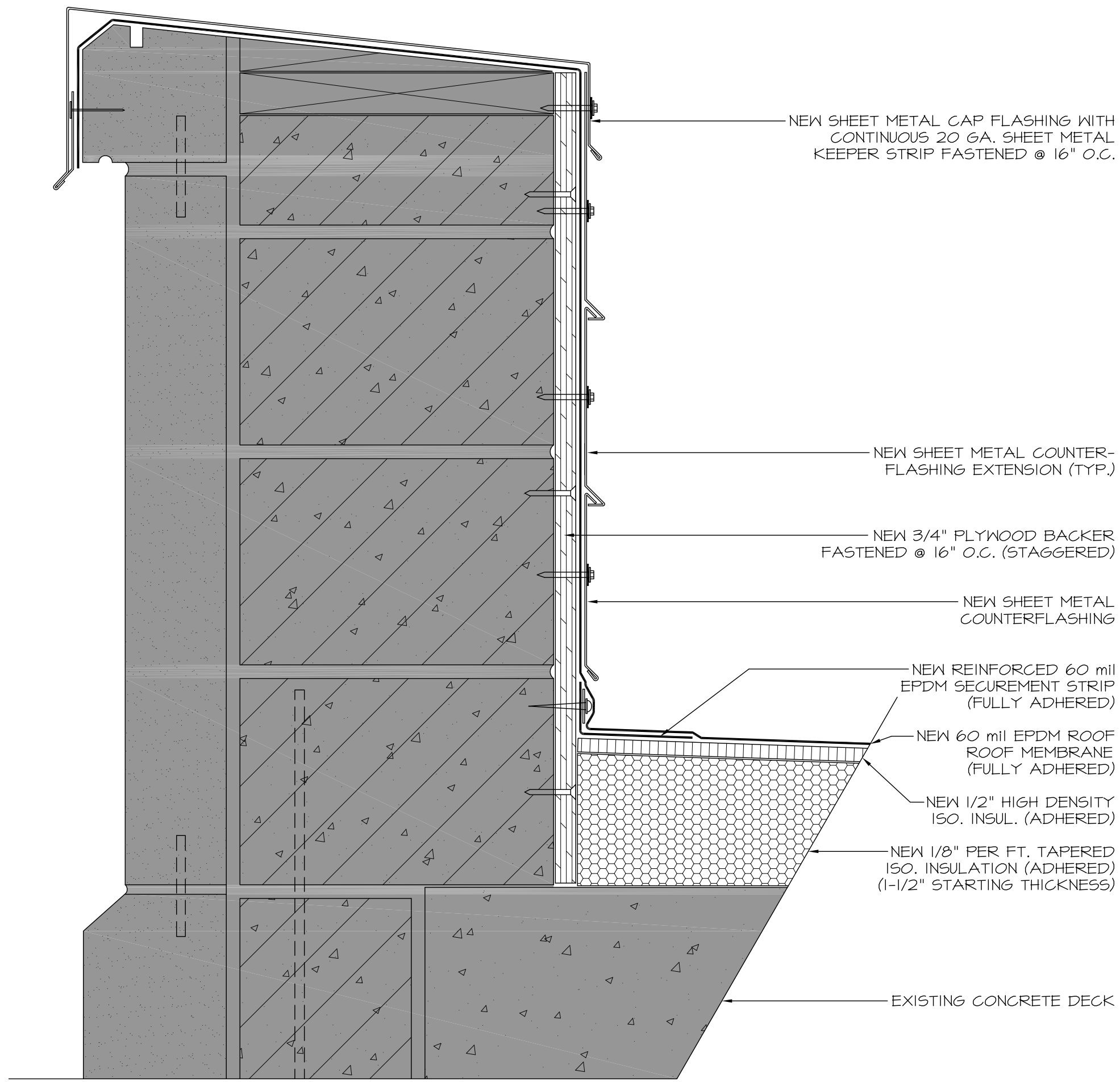

**4** PARAPET FLASHING DETAIL  
2 SCALE: 3"=1'-0"

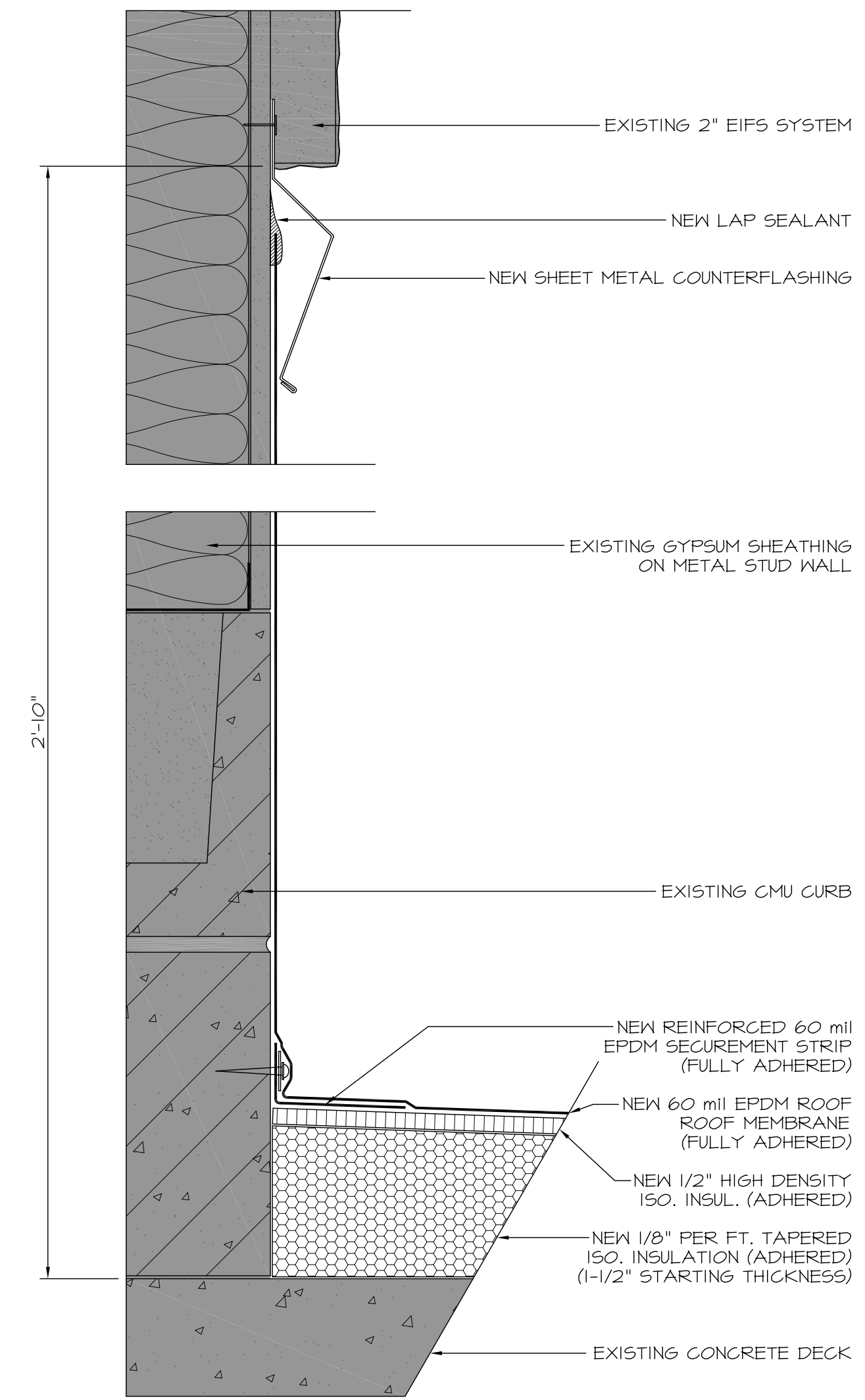

**5** WALL FLASHING DETAIL  
2 SCALE: 3"=1'-0"

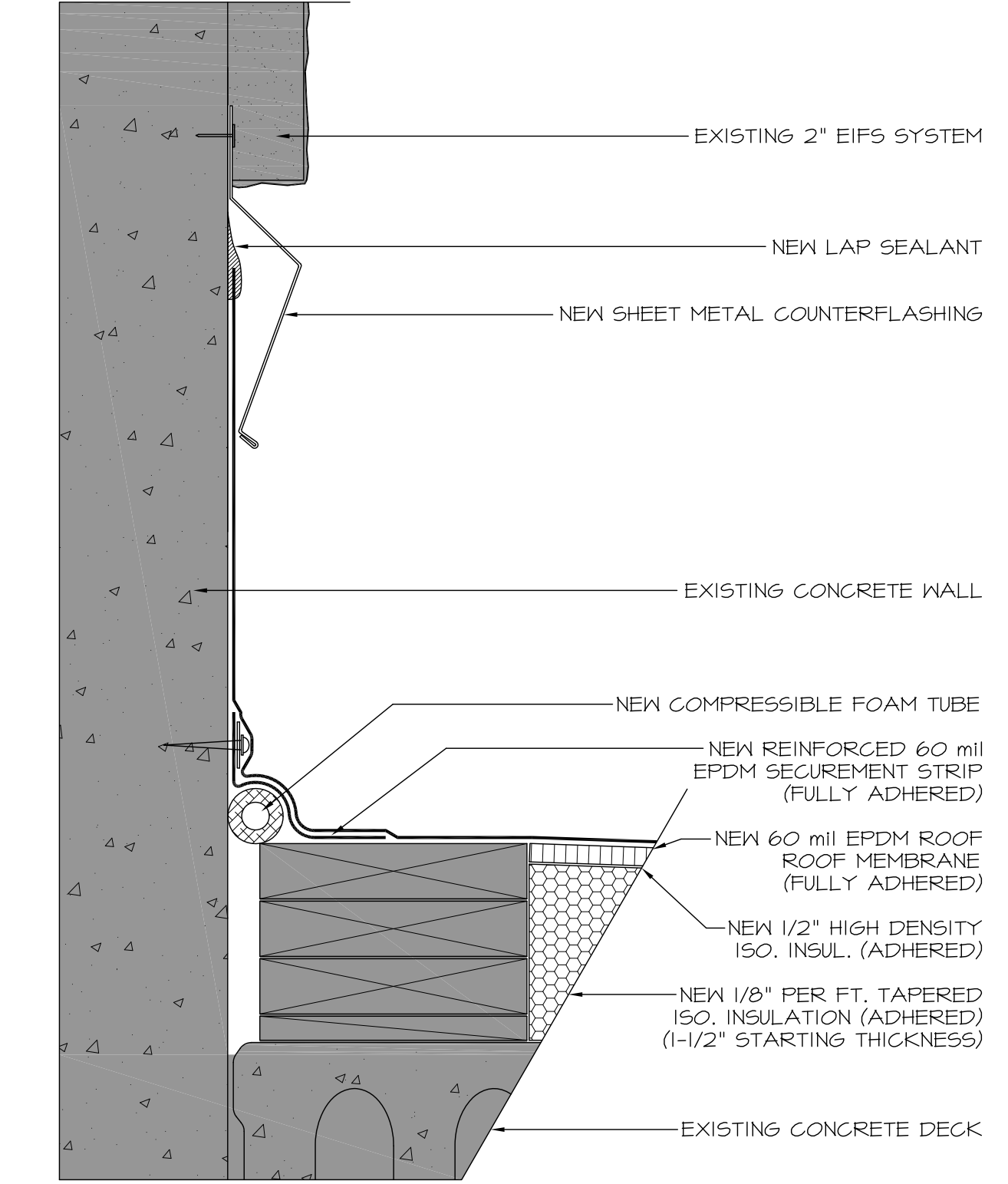

**6** WALL FLASHING DETAIL  
2 SCALE: 3"=1'-0"

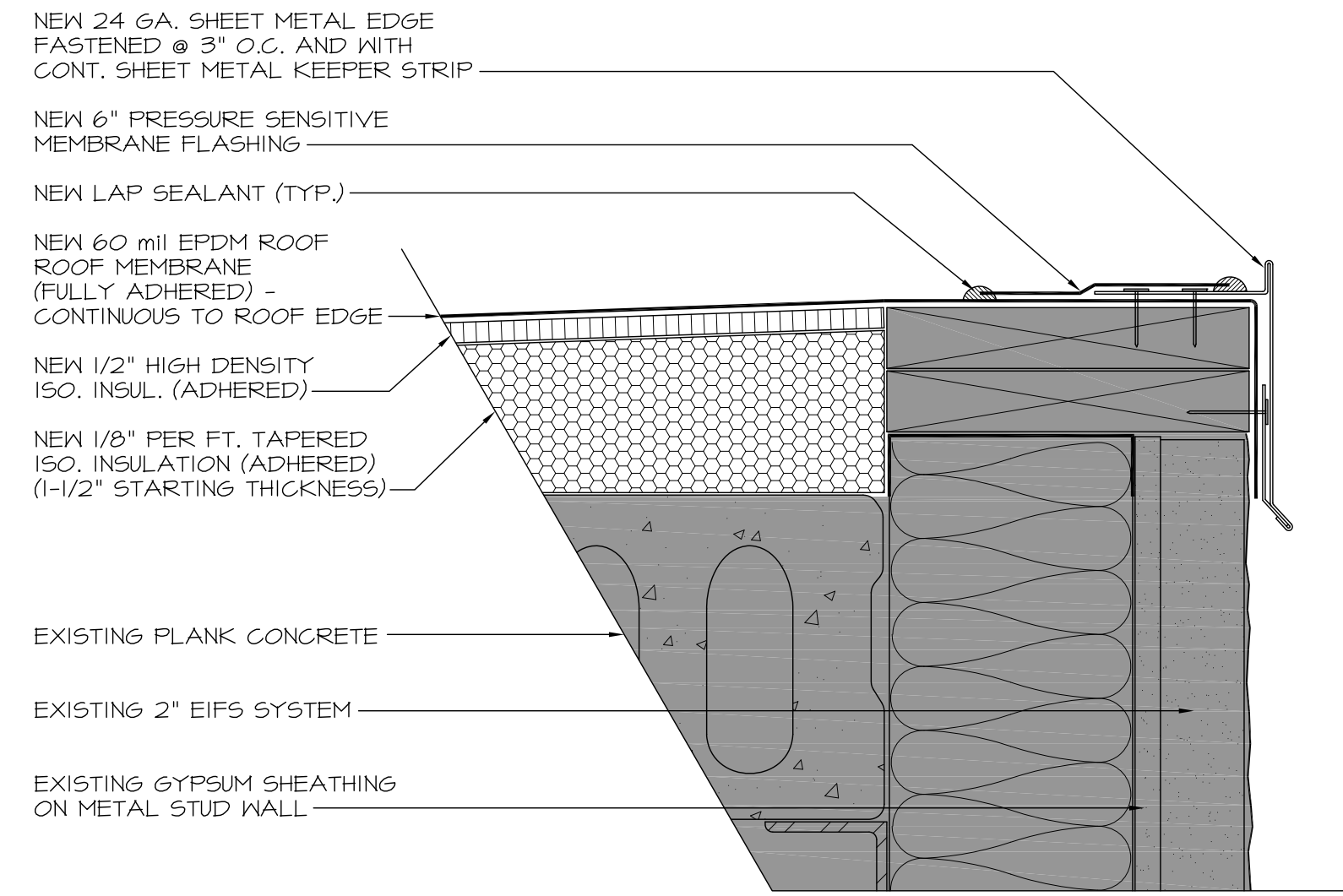

**7** EDGE FLASHING DETAIL  
2 SCALE: 3"=1'-0"

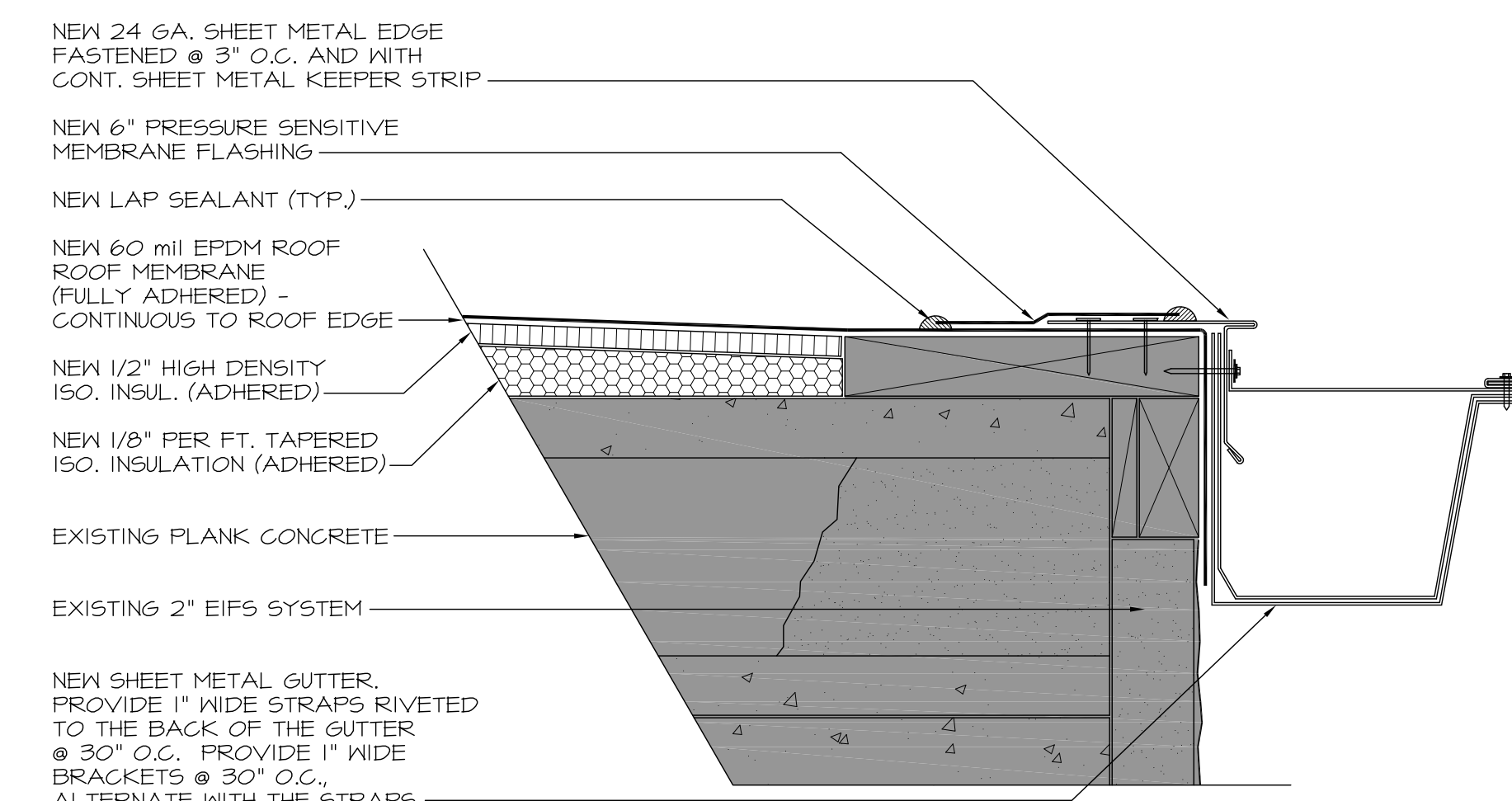

**8** GUTTER EDGE FLASHING  
2 SCALE: 3"=1'-0"

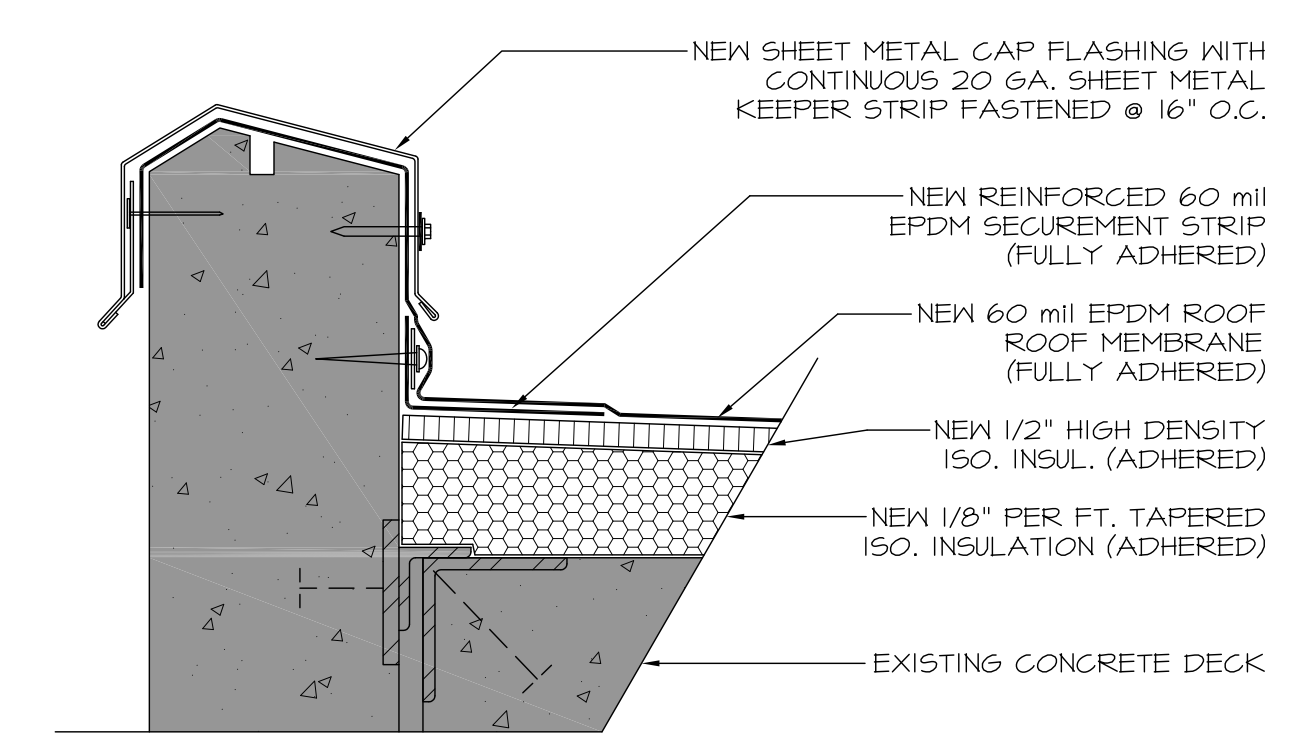

**9** CANOPY PARAPET FLASHING  
2 SCALE: 3"=1'-0"

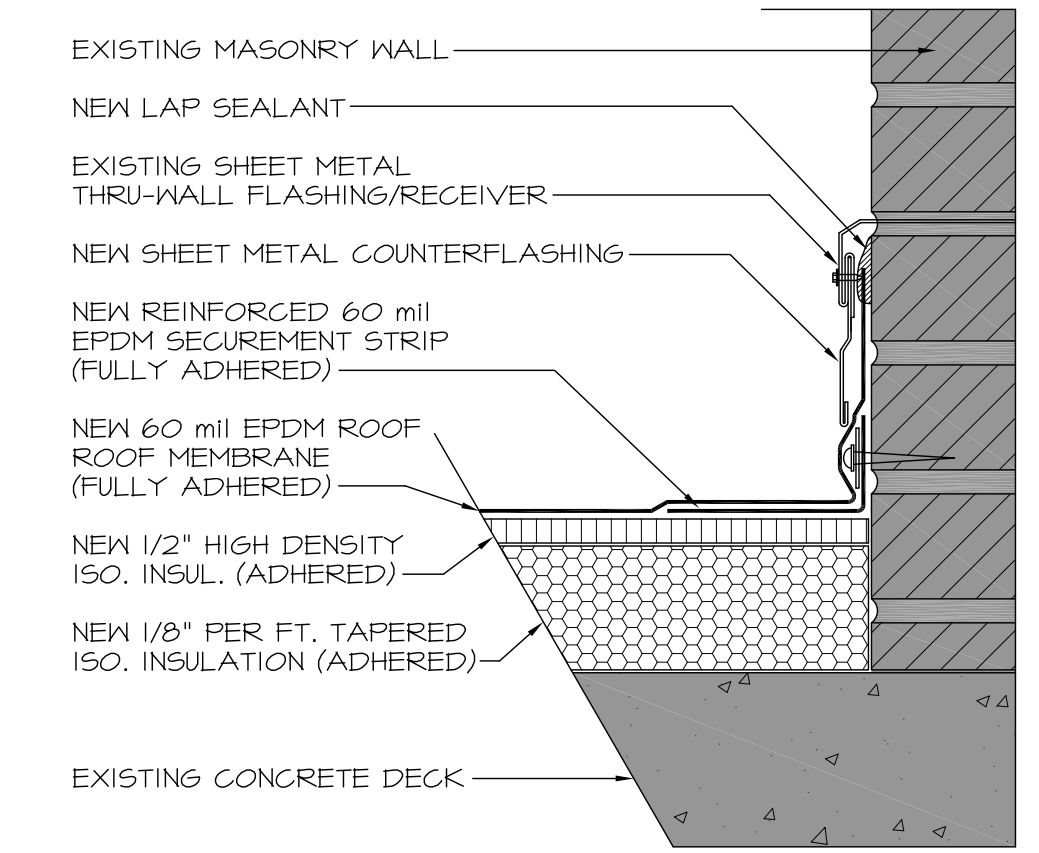

**10** WALL FLASHING DETAIL  
2 SCALE: 3"=1'-0"

15443-00/PUBLIC-SAFETY/DWG

PROJECT # 15443.00 SHEET:	<h1 style="font-size: 48pt; margin: 0;">2</h1>	OF 3	3207 Laura Lane Middleton, WI 53562 608-651-9535  SRI Consultants, Inc.
DATE: 06-19-19 CHECKED BY: T. COLLITON DESIGNED BY: SRI CONSULTANTS, INC. REVISED BY:	<b>PUBLIC SAFETY BUILDING</b> 115 WEST DOTY STREET MADISON, WISCONSIN 2019 ROOF REHABILITATION		
FOR:			



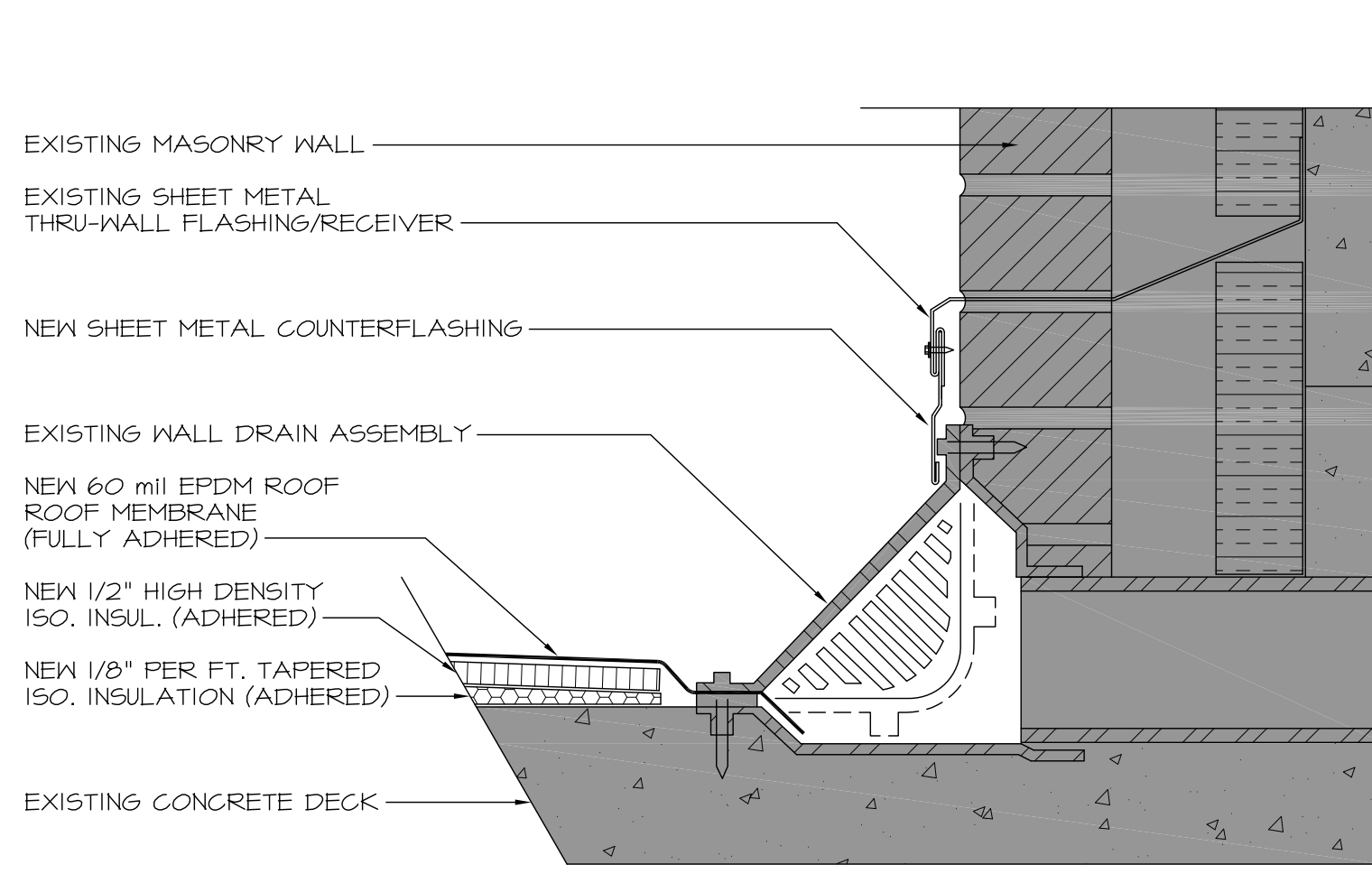

**11 WALL DRAIN FLASHING DETAIL**  
 3 SCALE: 3"=1'-0"

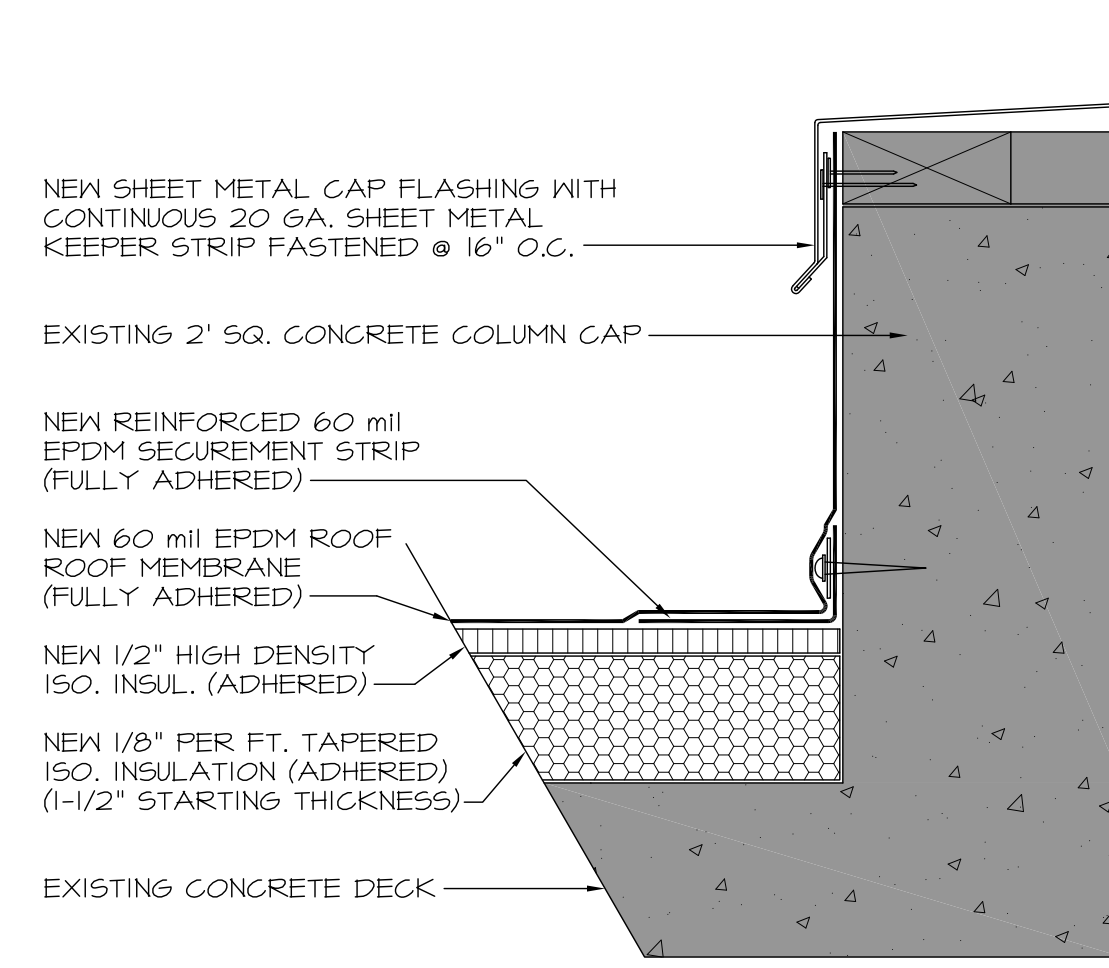

**12 COLUMN CAP FLASHING DETAIL**  
 3 SCALE: 3"=1'-0"

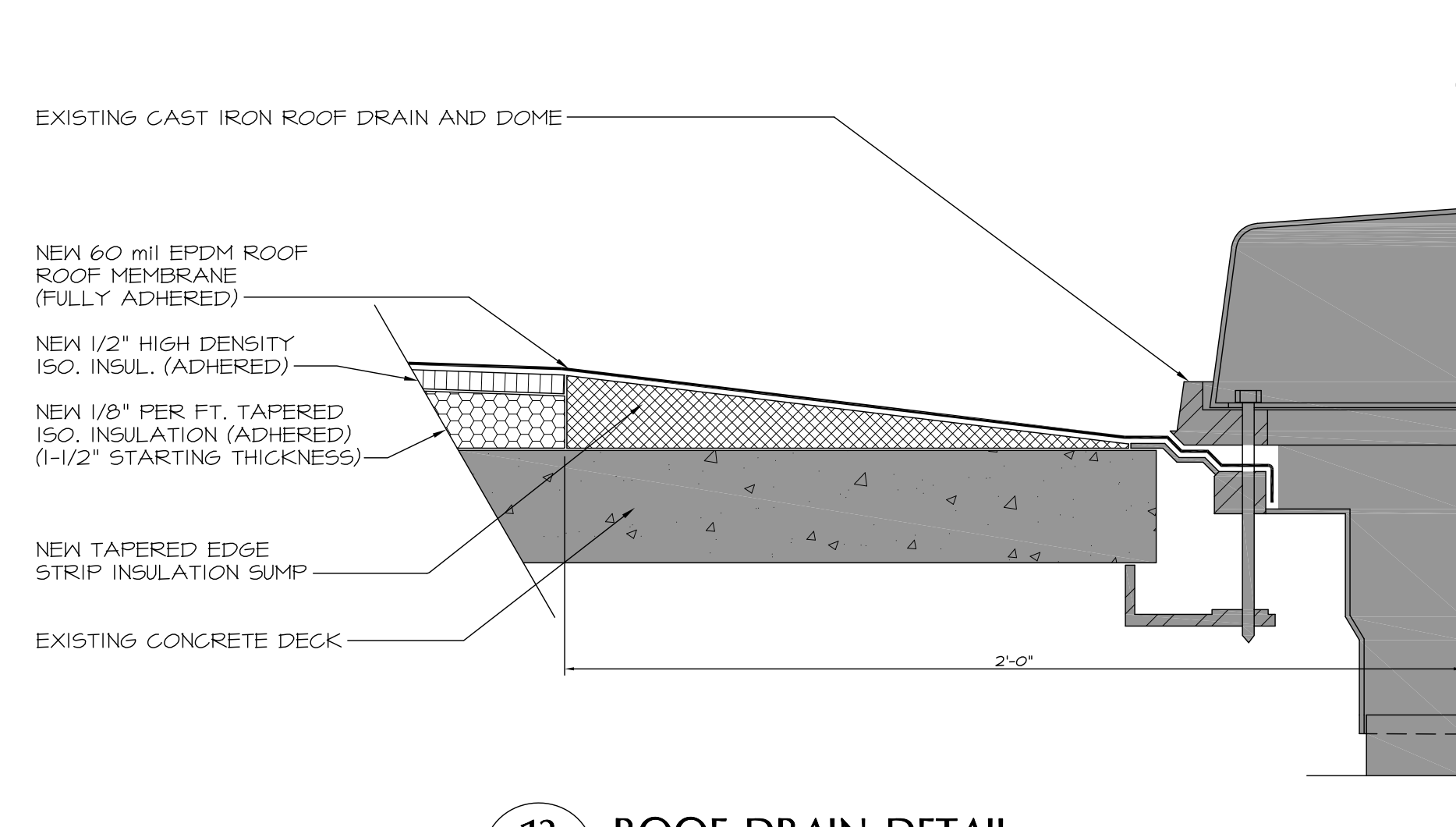

**13 ROOF DRAIN DETAIL**  
 3 SCALE: 3"=1'-0"

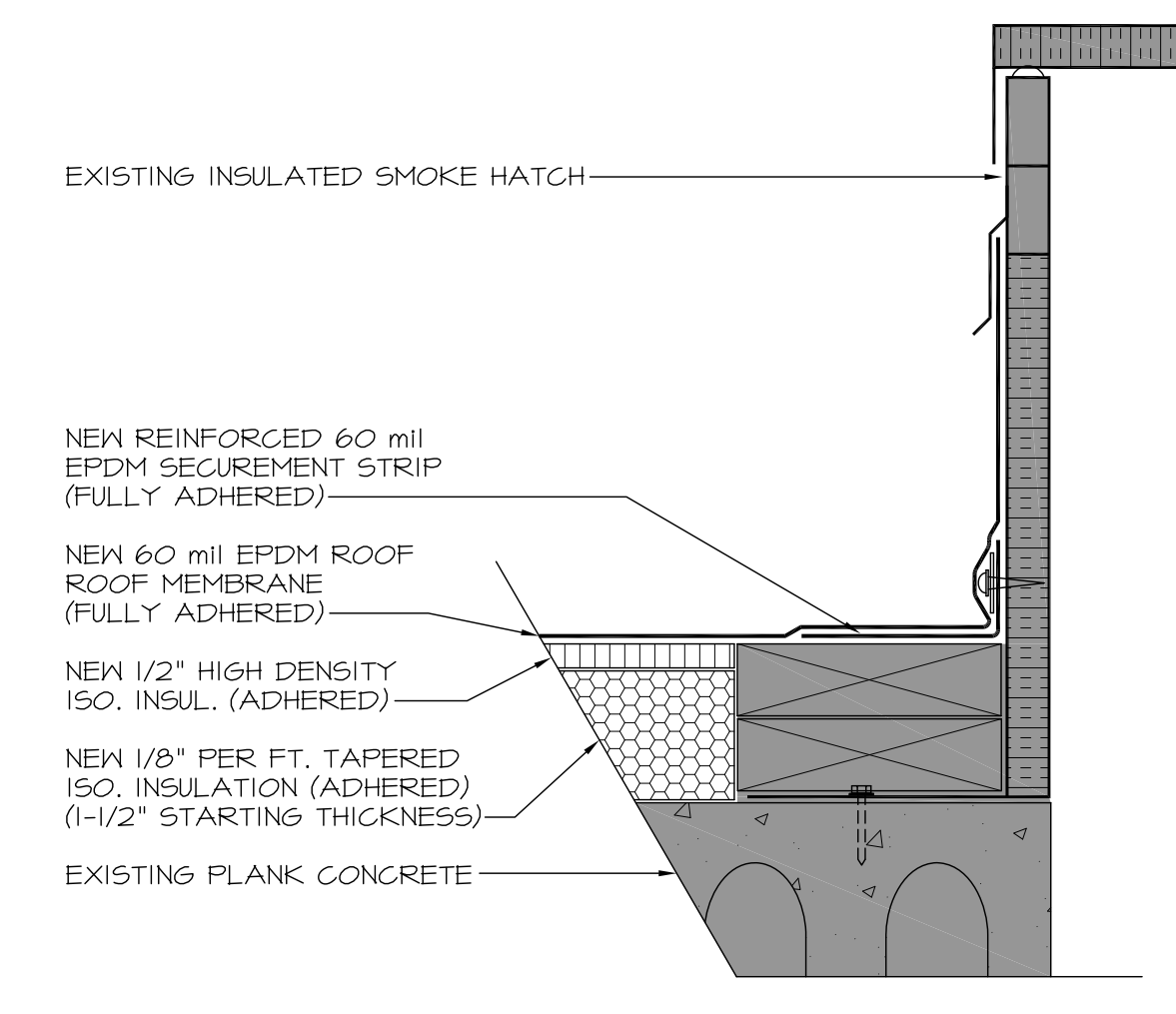

**14 SMOKE HATCH DETAIL**  
 3 SCALE: 3"=1'-0"

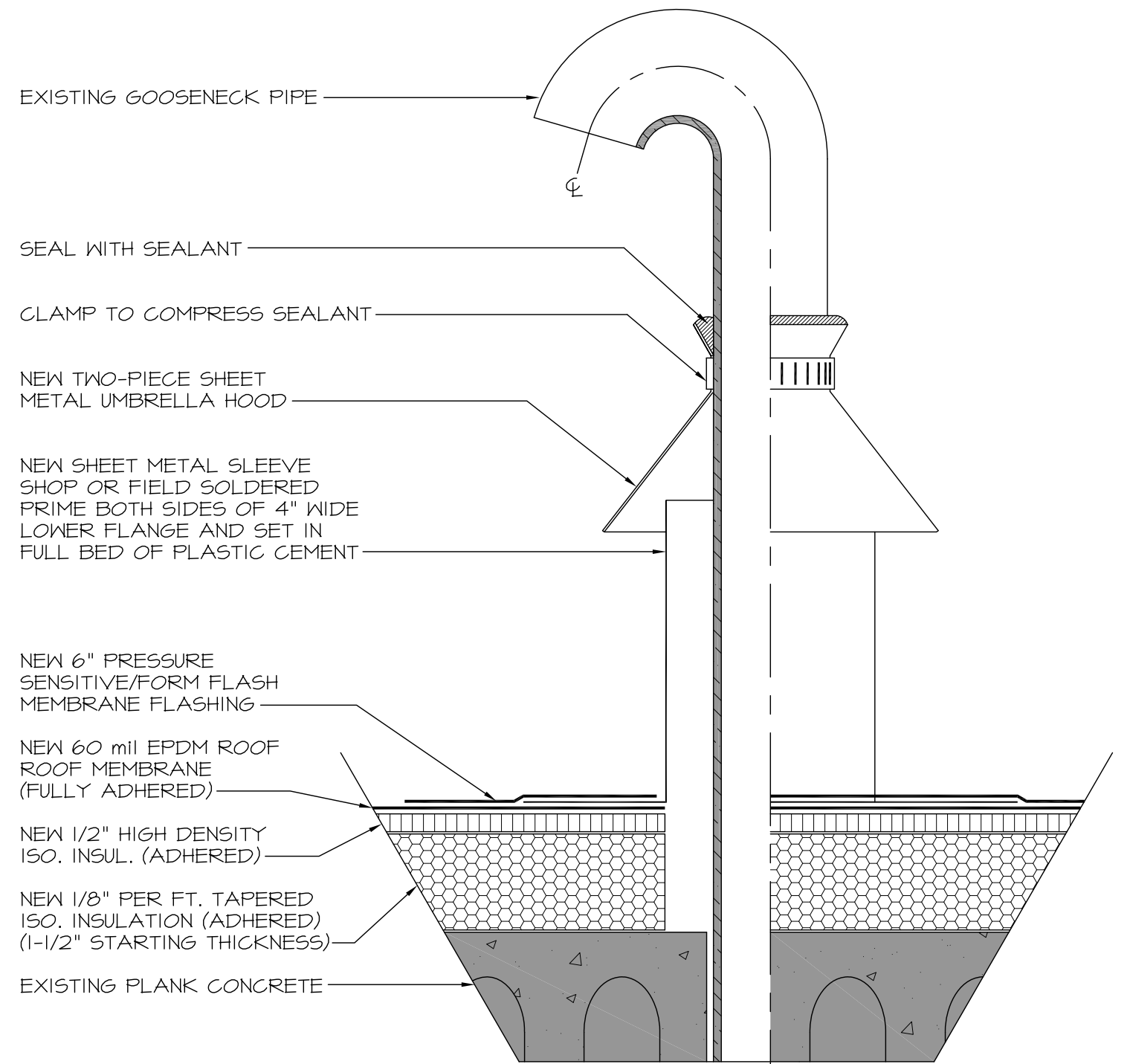

**15 GOOSENECK VENT DETAIL**  
 3 SCALE: 3"=1'-0"

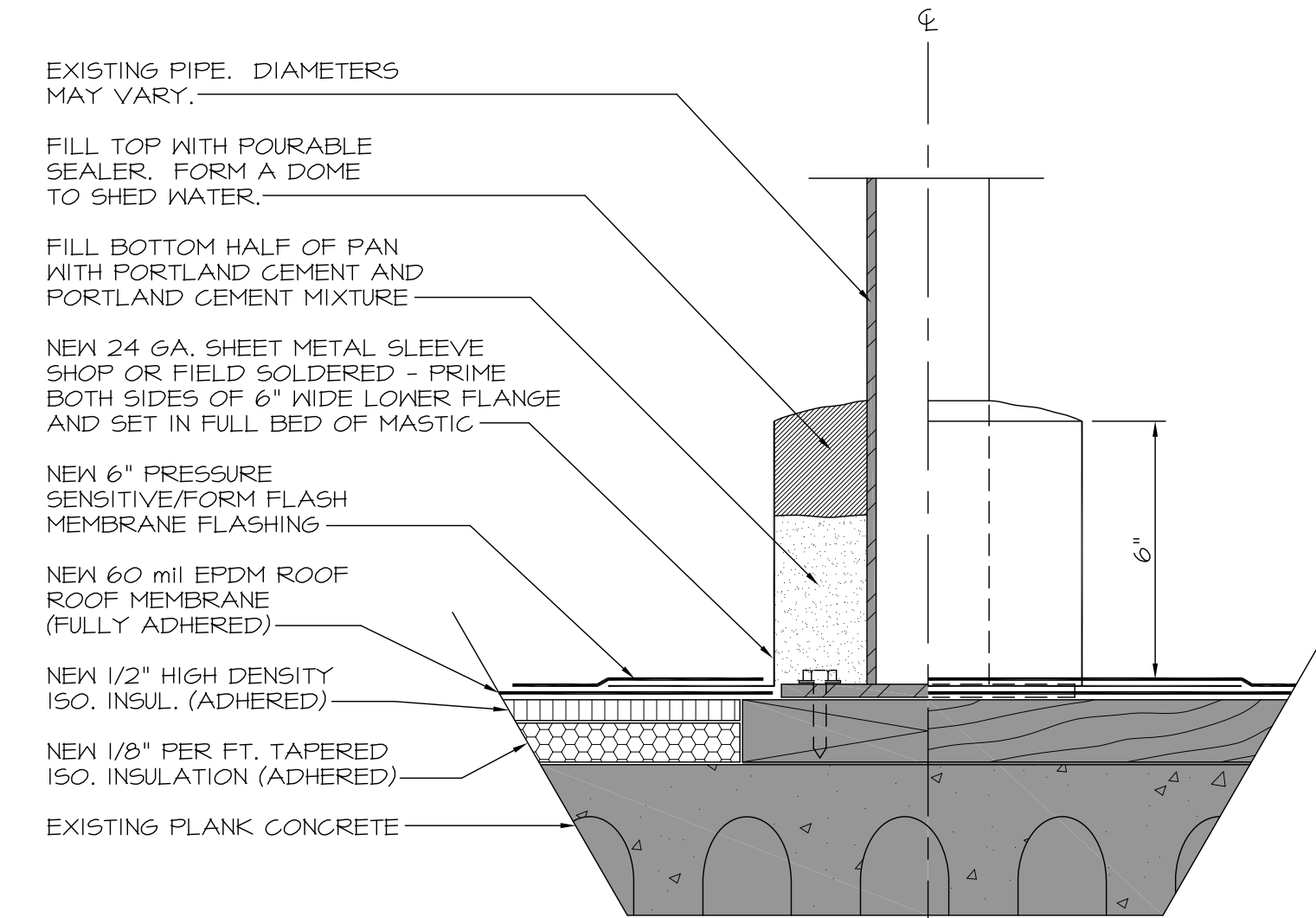

**16 RAILING SUPPORT DETAIL**  
 3 SCALE: 3"=1'-0"

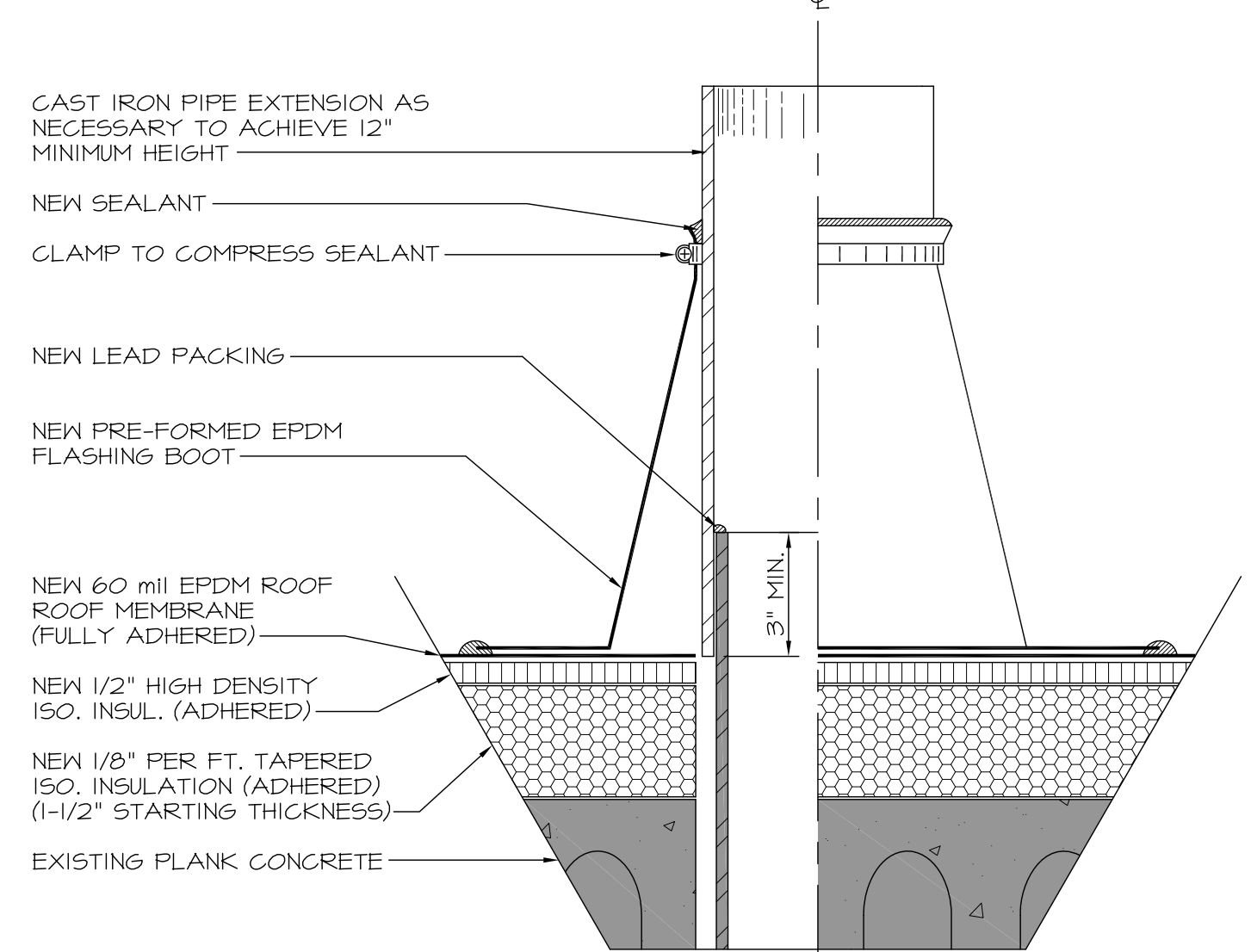

**17 PLUMBING VENT DETAIL**  
 3 SCALE: 3"=1'-0"

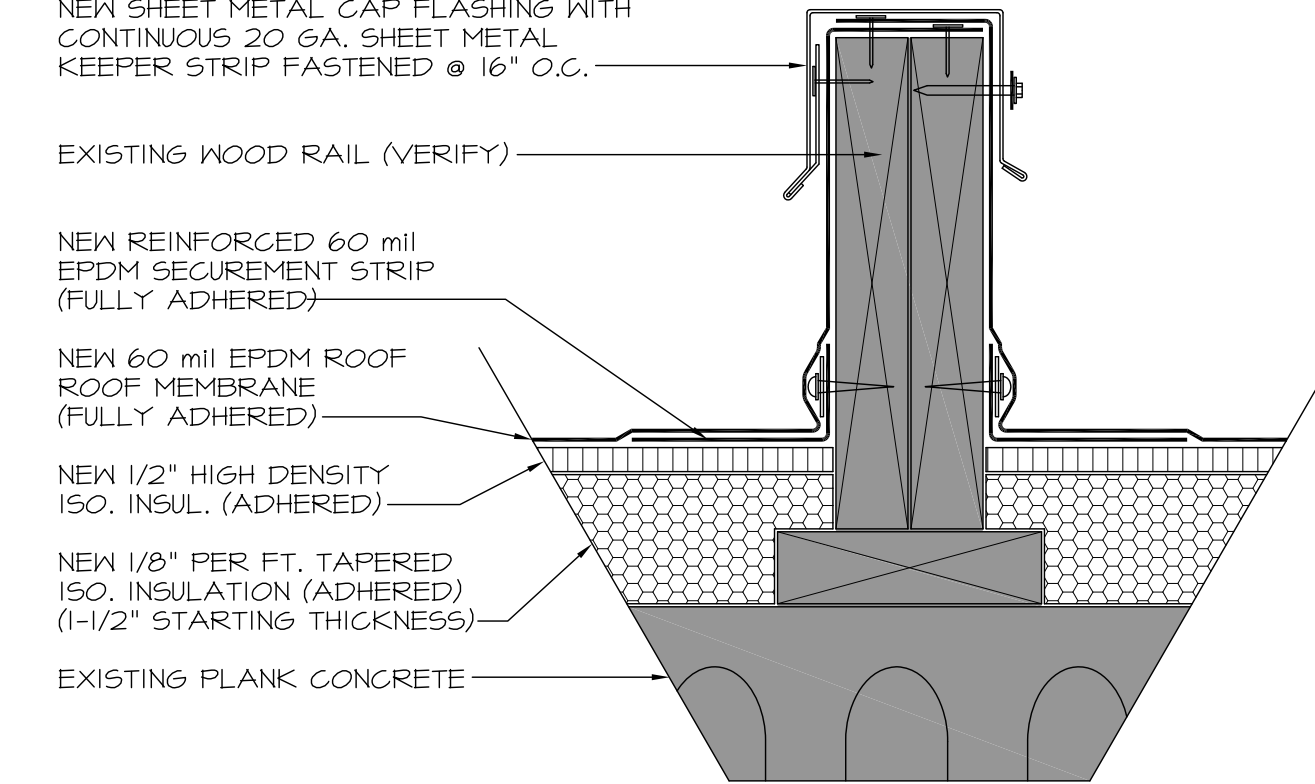

**18 SOLAR PANEL SUPPORT DETAIL**  
 3 SCALE: 3"=1'-0"

PROJECT # 15443.00	SHEET: 3 OF 3
DATE: 06-19-18	FROM:
DESIGNED BY: T. COLLITON	FOR: SRI CONSULTANTS, INC.
REVIEWED BY:	3207 Laura Lane Middleton, WI 53562 608-651-9535
<b>PUBLIC SAFETY BUILDING</b> 115 WEST DOTY STREET MADISON, WISCONSIN 2019 ROOF REHABILITATION	