

**RFB NO. 318031
(REBID)**

CONSTRUCTION DOCUMENTS PROJECT MANUAL

DANE COUNTY DEPARTMENT OF PUBLIC WORKS,
HIGHWAY AND TRANSPORTATION

PUBLIC WORKS ENGINEERING DIVISION
1919 ALLIANT ENERGY CENTER WAY
MADISON, WISCONSIN 53713

REQUEST FOR BIDS NO. 318031 HERPETARIUM ROOF REPLACEMENT (REBID) HENRY VILAS ZOO 702 S RANDALL AVE MADISON, WISCONSIN

Due Date / Time: **TUESDAY, DECEMBER 10, 2019 / 2:00 PM**

Location: **PUBLIC WORKS OFFICE**

Performance / Payment Bond: **100% OF CONTRACT AMOUNT**

Bid Deposit: **5% OF BID AMOUNT**

FOR INFORMATION ON THIS REQUEST FOR BIDS, PLEASE CONTACT:

ERIC URTEGAS, AIA, PROJECT MANAGER
TELEPHONE NO.: 608/266-4798
FAX NO.: 608/267-1533
E-MAIL: URTEGAS.ERIC@COUNTYOFDANE.COM

TABLE OF CONTENTS FOR RFB NO. 318031

DIVISION 00 - PROCUREMENT AND CONTRACTING REQUIREMENTS

- Project Manual Cover Page
- Table of Contents
- Advertisement for Bids (Legal Notice)
- Best Value Contracting Application
- Instructions to Bidders
- Bid Form
- Fair Labor Practices Certification
- Sample Public Works Construction Contract
- Sample Bid Bond
- Sample Performance Bond
- Sample Payment Bond
- General Conditions of Contract
- Supplementary Conditions

DIVISION 01 - GENERAL REQUIREMENTS

- 01 00 00 - Basic Requirements
- 01 74 19 - Construction Waste Management, Disposal & Recycling
- 00600 – Sample Storage Agreement
- 00700 – General and Supplementary Conditions
- 01090 – References
- 01091 – Definitions
- 01300 – Submittals
- 01400 – Quality Requirements
- 01630 – Substitutions and Product Options

DIVISION 02 - SITEWORK

- Section 02070 - Demolition

DIVISION 06 - WOOD, PLASTICS AND COMPOSITES

- Section 06010 – General Carpentry

DIVISION 07 - THERMAL AND MOISTURE PROTECTION

- Section 07201 - Insulation
- Section 07310 – Asphalt Shingles

DRAWINGS

- Sheet No. 1 - Roof Plan and Details

LEGAL NOTICE

INVITATION TO BID

Dane County Dept. of Public Works, Hwy & Transp., 1919 Alliant Energy Center Way, Madison, WI 53713, will receive sealed Bids until:

2:00 P.M., TUESDAY, DECEMBER 10, 2019

RFB NO. 318031

HERPETARIUM ROOF REPLACEMENT (REBID)

HENRY VILAS ZOO HERPETARIUM

702 S RANDALL AVE

MADISON, WI

Dane County is inviting Bids for construction services. Dane County is looking to replace the roof on the Herpetarium building. Only firms with capabilities, experience & expertise with similar projects should obtain this Request for Bids document & submit Bids.

Request for Bids document may be obtained after **2:00 p.m. on October 29, 2019** by downloading it from bids-pwht.countyofdane.com. Please call J. Eric Urtes, AIA Project Manager, at 608/266-4798, or our office at 608/266-4018, for any questions or additional information.

A pre-bid site tour will be held November 20, 2019 at 10:00 a.m. at The Henry Vilas Zoo, starting outside of the Herpetarium. Bidders are required to attend this mandatory tour in order to bid on the Work.

PUBLISH: OCTOBER 29 & NOVEMBER 5, 2019 - WISCONSIN STATE JOURNAL
OCTOBER 29 & NOVEMBER 5, 2019- THE DAILY REPORTER



Department of Public Works, Highway & Transportation
Public Works Engineering Division

608/266-4018

Gerald J. Mandli, P.E.
Commissioner / Director

Joseph T. Parisi
County Executive

Deputy Director
Todd Draper

1919 Alliant Energy Center Way
Madison, Wisconsin 53713
Fax: 608/267-1533
www.countyofdane.com/pwht/public_works.aspx

BEST VALUE CONTRACTING APPLICATION

CONTRACTORS / LICENSURE APPLICANTS

The Dane County Department of Public Works requires all contractors to be pre-qualified as a best value contractor with the County prior to being awarded a contract. In addition, the County pre-qualifies potential contractors and sub-contractors who wish to work on County contracts. Subcontractors must become pre-qualified ten (10) days prior to commencing work under any Dane County Public Works Contract. Potential subcontractors are urged to become pre-qualified as early as possible. This document shall be completed, properly executed, along with the necessary attachments and additional information that the County requires for the protection and welfare of the public in the performance of a County contract.

Contractors or subcontractors of any tier who attain pre-qualification status will retain that status for a period of two (2) years from the date of qualification. Contractors shall notify the Dane County Department of Public Works, Highway & Transportation within fifteen (15) days of any changes to its business or operations that are relevant to the pre-qualification application. Failure to do so could result in suspension, revocation of the contractor's pre-qualification, debarment from County contracts for up to three (3) years and / or other sanctions available under the law.

No contracts will be awarded for construction work performed on Dane County projects unless the contractor is currently approved as a Wisconsin Trade Trainer or has applied for approval as an Apprenticeship Trade Trainer to the Wisconsin Department of Workforce Development and agrees to an acceptable apprenticeship program. If you are not currently approved as a Wisconsin Trade Trainer, or have not applied for approval as an Apprenticeship Trade Trainer, please contact the Department of Workforce Development - Bureau of Apprenticeship Standards at 608/266-3133 or visit their web site at: dwd.wisconsin.gov/apprenticeship/.

EXEMPTIONS

- Contractors who employ less than five (5) apprenticeable trade workers are not required to pre-qualify.
- Contractors performing work that does not apply to an apprenticeable trade, as outlined in Appendix A.
- The contractor / subcontractor provides sufficient documentation to demonstrate one or more of the following:
 - apprentices are not available in a specific geographic area;
 - the applicable apprenticeship program is unsuitable or unavailable; or
 - there is a documented depression of the local construction market which prevents compliance.

SEC.	PROOF OF RESPONSIBILITY	CHECK IF APPLICABLE
1	Does your firm possess all technical qualifications and resources, including equipment, personnel and financial resources, necessary to perform the work required for any project or obtain the same through the use of responsible, pre-qualified subcontractors?	Yes: <input type="checkbox"/> No: <input type="checkbox"/>
2	Will your firm possess all valid, effective licenses, registrations or certificates required by federal, state, county, or local law, which are necessary for the type of work to be performed including, but not limited to, those for any type of trade work or specialty work?	Yes: <input type="checkbox"/> No: <input type="checkbox"/>
3	Will your firm meet all bonding requirements as required by applicable law or contract specifications?	Yes: <input type="checkbox"/> No: <input type="checkbox"/>
4	Will your firm meet all insurance requirements as required by applicable law or specifications, including general liability insurance, workers compensation insurance and unemployment insurance requirements?	Yes: <input type="checkbox"/> No: <input type="checkbox"/>
5	Will your firm maintain a substance abuse policy for employees hired for public works contracts that comply with Wis. Stats. Sec. 103.503?	Yes: <input type="checkbox"/> No: <input type="checkbox"/>
6	Does your firm acknowledge that it must pay all craft employees on public works projects the wage rates and benefits required under Section 66.0903 of the Wisconsin Statutes?	Yes: <input type="checkbox"/> No: <input type="checkbox"/>
7	Will your firm fully abide by the equal opportunity and affirmative action requirements of all applicable laws, including County ordinances?	Yes: <input type="checkbox"/> No: <input type="checkbox"/>
8	In the past three (3) years, has your firm had control or has another corporation, partnership or other business entity operating in the construction industry controlled it? If so, please attach a statement explaining the nature of the firm relationship?	Yes: <input type="checkbox"/> No: <input type="checkbox"/> If Yes, attach details.
9	In the past three (3) years, has your firm had any type of business, contracting or trade license, certification or registration revoked or suspended?	Yes: <input type="checkbox"/> No: <input type="checkbox"/> If Yes, attach details.
10	In the past three (3) years, has your firm been debarred by any federal, state or local government agency?	Yes: <input type="checkbox"/> No: <input type="checkbox"/> If Yes, attach details.
11	In the past three (3) years, has your firm defaulted or failed to complete any contract?	Yes: <input type="checkbox"/> No: <input type="checkbox"/> If Yes, attach details.
12	In the past three (3) years, has your firm committed a willful violation of federal, state or local government safety laws as determined by a final decision of a court or government agency authority.	Yes: <input type="checkbox"/> No: <input type="checkbox"/> If Yes, attach details.
13	In the past three (3) years, has your firm been in violation of any law relating to your contracting business where the penalty for such violation resulted in the imposition of a penalty greater than \$10,000?	Yes: <input type="checkbox"/> No: <input type="checkbox"/> If Yes, attach details.
14	Is your firm Executive Order 108 pre-certified with the State of Wisconsin?	Yes: <input type="checkbox"/> No: <input type="checkbox"/>
15	Is your firm an active Wisconsin Trade Trainer as determined by the Wisconsin Bureau of Apprenticeship Standards?	Yes: <input type="checkbox"/> No: <input type="checkbox"/>
16	Is your firm exempt from being pre-qualified with Dane County?	Yes: <input type="checkbox"/> No: <input type="checkbox"/> If Yes, attach reason for exemption.
17	Does your firm acknowledge that in doing work under any County Public Works Contract, it will be required to use as subcontractors only those contractors that are also pre-qualified with the County or become so ten days prior to commencing work?	Yes: <input type="checkbox"/> No: <input type="checkbox"/>
18	Contractor has been in business less than one year?	Yes: <input type="checkbox"/> No: <input type="checkbox"/>
19	Is your firm a first time Contractor requesting a one time exemption, but, intend to comply on all future contracts and are taking steps typical of a "good faith" effort?	Yes: <input type="checkbox"/> No: <input type="checkbox"/>
20	Not applicable. My firm does not intend to work on Best Value Contracts. Note: Best Value Contracting is required to bid on most Public Works Contracts (if unclear, please call Todd Draper 608-267-0119).	Yes: <input type="checkbox"/> No: <input type="checkbox"/>

SIGNATURE SECTION

Your firm's Officer, or the individual who would sign a bid and / or contract documents must sign this document.

I do hereby certify that all statements herein contained are true and correct to the best of my knowledge:

Signature: _____

(Application is invalid without signature)

Print Name: _____ Date: _____

Title: _____

NAME AND ADDRESS OF CONTRACTOR	
Name of Firm:	
Address:	
City, State, Zip:	
Phone Number:	
Fax Number:	
E-mail Address:	

REMEMBER!

RETURN ALL TO FORMS AND ATTACHMENTS, OR QUESTIONS TO:

**TODD DRAPER
EMAIL: DRAPER@COUNTYOFDANE.COM
OFFICE: (608)267-0119, FAX: (608)267-1533**

**DANE COUNTY DEPARTMENT OF PUBLIC WORKS, HIGHWAY & TRANSPORTATION
1919 ALLIANT ENERGY CENTER WAY
MADISON, WI 53713**

APPENDIX A

APPRENTICEABLE TRADES:

- Bricklayer
- Carpenter
- Cement Mason (Concrete Finisher)
- Cement Mason (Heavy Highway)
- Construction Craft Laborer
- Data Communications Installer
- Electrician
- Elevator Mechanic / Technician
- Environmental Systems Technician / HVAC Service Technician / HVAC Install & Service
- Glazier
- Heavy Equipment Operator / Operating Engineer
- Insulation Worker (Heat & Frost)
- Iron Worker (Assembler, Metal Buildings)
- Painter / Decorator
- Plasterer
- Plumber
- Roofer / Waterproofer
- Sheet Metal Worker
- Sprinkler Fitter
- Steamfitter (Service & Refrigeration)
- Taper & Finisher
- Telecommunications (Voice, Data & Video) Installer / Technician
- Tile Setter

INSTRUCTIONS TO BIDDERS

Herpetarium Roof Replacement (REBID)
Henry Vilas Zoo
702 S Randall Ave
Madison, Wisconsin

1. SECURING DOCUMENTS

- A. Construction Documents may be obtained at bids-pwht.countyofdane.com.
- B. Bidder is responsible to check Public Works website regularly for Addenda.
- C. Construction Documents may be obtained at:
 - Dane County Department of Public Works, Highway & Transportation
 - 1919 Alliant Energy Center Way, Madison, Wisconsin 53713
 - 608/266-4018
- D. Deposit for Drawings and Specifications required.
- E. For deposit refund, return complete sets of Drawings and Specifications to same location they were picked up within 120 calendar days after Bid Due Date. After that time, deposit will be forfeited.

2. BID REQUIREMENTS

- A. Bidder shall submit bid for providing all necessary to perform all Work described in Construction Documents.
- B. Envelope containing Bid shall be clearly marked as for this project (note title at top of page). Bids shall be delivered to:
 - Dane County Department of Public Works, Highway & Transportation
 - 1919 Alliant Energy Center Way
 - Madison, Wisconsin 53713
- C. One (1) Bid Form shall be submitted with your Bid. Bid Form is provided with Construction Documents; no other form or letter shall be accepted.
- D. Wisconsin Statute 77.54 (9m) allows building materials that become part of local unit government facilities to be exempt from sales & use tax. Vendors & materials suppliers may not charge Bidders sales & use tax on these purchases. This does not include highways, streets or roads.
- E. Bidders shall not add any conditions, escalator clauses or qualifying statements to Bid Form.
- F. Erasures or other changes to Bid must be explained or noted, and shall be accompanied by initials of bidder.
- G. Legally authorized official of bidder's organization shall sign Bids.

- H. Bidder's organization shall submit completed Fair Labor Practices Certification Form, included in these Construction Documents.
- I. Bid Bond shall be made payable to Dane County in amount of five percent (5%) of bid amount. Bid Bond shall be either certified check or bid bond issued by surety licensed to conduct business in the State of Wisconsin. Successful bidder's Bid Bond shall be retained until Contract is signed and required Performance / Payment Bond is submitted. Bids shall be binding on bidder for sixty (60) calendar days after Bid Due Date. Bid Bond must be submitted with Bid.
- J. Successful bidder shall furnish and pay for Performance / Payment Bond as called for in Conditions of Contract.

3. INQUIRIES

- K. Written inquiries regarding intent of Construction Documents should be directed to:

Eric Urtes, AIA, Public Works Project Manager
Dane County Department of Public Works, Highway & Transportation
1919 Alliant Energy Center Way, Madison, Wisconsin 53713
Fax: 608/267-1533
Email: urtes.eric@countyofdane.com

- L. Bidders shall bring questions, discrepancies, omissions, conflicts or doubt as to meaning of any part of Construction Documents to attention of Department of Public Works, Highway & Transportation at least ten (10) business days before due date for Bids. Prompt clarification of intent of Construction Documents shall be made available to bidders in form of Addendum. Bidder shall acknowledge all Addenda on Bid Form.
- M. Failure to request clarification of interpretation of Construction Documents shall not relieve bidders of their responsibilities to perform Work.

4. EXAMINATION OF SITE

- N. Coordinate site access activities with .
- O. A bidders facility tour will be held on June 10 at 10:00am at Henry Vilas Zoo, 702 S Randall Ave, Madison, starting in Outside the Henry Vilas Zoo Herpetarium. This tour will go until approximately . are strongly encouraged to attend this tour.

5. ALTERNATES

NOT USED. 6. WITHDRAWAL OF BIDS

- P. Any bidder may withdraw their Bid any time prior to Bid Due Date. Withdrawn Bids shall be returned unopened.

7. BID DUE DATE

- Q. See Legal Notice (advertisement).

8. COMMENCEMENT AND COMPLETION OF WORK

- R. Work shall commence by .

S. Work shall be completed by .

9. RESERVATION

T. Dane County reserves the right to reject any or all Bids, to waive any informalities in the Bid, and to accept any Bid which shall be in the best interest of Dane County.

Name of Bidding Firm: _____

BID FORM

BID NO. 318031

**PROJECT: HERPETARIUM ROOF REPLACEMENT (REBID)
HENRY VILAS ZOO**

**TO: DANE COUNTY DEPARTMENT OF PUBLIC WORKS, HIGHWAY &
TRANSPORTATION PROJECT MANAGER
1919 ALLIANT ENERGY CENTER WAY
MADISON, WISCONSIN 53713**

**NOTE: WISCONSIN STATUTE 77.54 (9M) ALLOWS FOR NO SALES & USE TAX ON
THE PURCHASE OF MATERIALS FOR COUNTY PUBLIC WORKS PROJECTS.**

BASE BID - LUMP SUM:

Henry Vilas Zoo is seeking to have the roof replaced for the Herpetarium. The undersigned, having examined the site where the Work is to be executed and having become familiar with local conditions affecting the cost of the Work and having carefully examined the Drawings and Specifications, all other Construction Documents and Addenda thereto prepared by Dane County Department of Public Works, Highway & Transportation hereby agrees to provide all labor, materials, equipment and services necessary for the complete and satisfactory execution of the entire Work, as specified in the Construction Documents, for the Base Bid stipulated sum of:

_____ and _____ /100 Dollars
Written Price

\$ _____
Numeric Price

Receipt of the following addenda and inclusion of their provisions in this Bid is hereby acknowledged:

Addendum No(s). _____ through _____

Dated _____

Dane County Henry Vilas Zoo must have this project completed by July 31, 2020. Assuming this Work can be started by January 28, 2020, what dates can you commence and complete this job?

Commencement Date: _____ Completion Date: _____
(final, not substantial)

I hereby certify that all statements herein are made on behalf of:

(Name of Corporation, Partnership or Person submitting Bid)

Select one of the following:

1. A corporation organized and existing under the laws of the State of _____, or
2. A partnership consisting of _____, or
3. A person conducting business as _____;

Of the City, Village, or Town of _____ of the State of _____.

I have examined and carefully prepared this Bid from the associated Construction Documents and have checked the same in detail before submitting this Bid; that I have full authority to make such statements and submit this Bid in (its) (their) (my) behalf; and that the said statements are true and correct. In signing this Bid, we also certify that we have not, either directly or indirectly, entered into any agreement or participated in any collusion or otherwise taken any action in restraint of free competition; that no attempt has been made to induce any other person or firm to submit or not to submit a Bid; that this Bid has been independently arrived at without collusion with any other bidder, competitor, or potential competitor; that this Bid has not been knowingly disclosed prior to the Bids Due Date to another bidder or competitor; that the above statement is accurate under penalty of perjury.

The undersigned further agrees to honor the Base Bid and the Alternate Bid(s) for sixty (60) calendar days from date of Award of Contract.

SIGNATURE: _____
(Bid is invalid without signature)

Print Name: _____ Date: _____

Title: _____

Address: _____

Telephone No.: _____ Fax No.: _____

Email Address: _____

Contact Person: _____

THIS PAGE IS FOR BIDDERS' REFERENCE AND NEED NOT BE SUBMITTED WITH BID FORM.

BID CHECK LIST:

These items **must** be included with Bid:

Bid Form

Bid Bond

Fair Labor Practices Certification

BIDDERS SHOULD BE AWARE OF THE FOLLOWING:

DANE COUNTY VENDOR REGISTRATION PROGRAM

All bidders are strongly encouraged to be a registered vendor with Dane County. Registering allows vendors an opportunity to receive notifications for RFBs & RFPs issued by the County and provides the County with up-to-date company contact information. Complete a new form or renewal online at:

danepurchasing.com/Account/Login?

DANE COUNTY BEST VALUE CONTRACTING PRE-QUALIFICATION

Contractors must be pre-qualified as a Best Value Contractor with the Dane County Public Works Engineering Division before the award of contract. Obtain a *Best Value Contracting Application* by calling 608/266-4018 or complete one online at:
countyofdane.com/pwht/BVC_Application.aspx

FAIR LABOR PRACTICES CERTIFICATION

The undersigned, for and on behalf of the BIDDER, APPLICANT or PROPOSER named herein, certifies as follows:

- A. That he or she is an officer or duly authorized agent of the above-referenced BIDDER, APPLICANT or PROPOSER, which has a submitted a bid, application or proposal for a contract or agreement with the county of Dane.
- B. That BIDDER, APPLICANT or PROPOSER has (check one):

_____ not been found by the National Labor Relations Board (“NLRB”) or the Wisconsin Employment Relations Commission (“WERC”) to have violated any statute or regulation regarding labor standards or relations in the seven years prior to the signature date of this Certification.

_____ been found by the National Labor Relations Board (“NLRB”) or the Wisconsin Employment Relations Commission (“WERC”) to have violated any statute or regulation regarding labor standards or relations in the seven years prior to the signature date of this Certification.

Officer or Authorized Agent Signature Date

Printed or Typed Name and Title

Printed or Typed Business Name

NOTE: You can find information regarding the violations described above at: www.nlrb.gov and werc.wi.gov.

For reference, Dane County Ordinance 25.09 is as follows:

- (1) BIDDER RESPONSIBILITY. (a) Any bid, application or proposal for any contract with the county, including public works contracts regulated under chapter 40, shall include a certification indicating whether the bidder has been found by the National Labor Relations Board (NLRB) or the Wisconsin Employment Relations Committee (WERC) to have violated any statute or regulation regarding labor standards or relations within the last seven years. The Controller shall investigate any such finding and make a recommendation to the committee, which shall determine whether the conduct resulting in the finding affects the bidder’s responsibility to perform the contract.

If you indicated that the NLRB or WERC have found you to have such a violation, you must include copies of any relevant information regarding such violation with your proposal, bid or application.

Include this completed Certification with your bid, application or proposal.

COUNTY OF DANE

PUBLIC WORKS CONSTRUCTION CONTRACT

Contract No. _____ Bid No. 318031 (REBID)

Authority: 2019 RES - _____

THIS CONTRACT, made and entered into as of the date by which authorized representatives of both parties have affixed their signatures, by and between the County of Dane (hereafter referred to as "COUNTY") and _____ (hereafter, "CONTRACTOR"), and

WITNESSETH:

WHEREAS, COUNTY, whose address is c/o Deputy Public Works Director, 1919 Alliant Energy Center Way, Madison, WI 53713, desires to have CONTRACTOR provide Herpetarium Roof Replacement 702 S Randall Ave, Madison, WI ("the Project"); and

WHEREAS, CONTRACTOR, whose address is _____ is able and willing to construct the Project, in accordance with the Construction Documents;

NOW, THEREFORE, in consideration of the above premises and the mutual covenants of the parties hereinafter set forth, the receipt and sufficiency of which is acknowledged by each party for itself, COUNTY and CONTRACTOR do agree as follows:

1. CONTRACTOR agrees to construct, for the price of \$ _____ the Project and at the CONTRACTOR'S own proper cost and expense to furnish all materials, supplies, machinery, equipment, tools, superintendence labor, insurance, and other accessories and services necessary to complete the Project in accordance with the conditions and prices stated in the Bid Form, Conditions of Contract, the drawings which include all maps, plats, plans, and other drawings and printed or written explanatory matter thereof, and the specifications therefore as prepared by _____ (hereinafter referred to as "the Architect / Engineer"), and as enumerated in the Project Manual Table of Contents, all of which are made a part hereof and collectively evidence and constitute the Contract.

2. COUNTY agrees to pay the CONTRACTOR in current funds for the performance of the Contract subject to additions and deductions, as provided in the Conditions of Contract, and to make payments on account thereof as provided in Article entitled, "Payments to Contractor" of the Conditions of Contract.

3. During the term of this Contract, CONTRACTOR agrees to take affirmative action to ensure equal employment opportunities. The CONTRACTOR agrees in accordance with Wisconsin Statute 111.321 and Chapter 19 of the Dane County Code of Ordinances not to discriminate on the basis of age, race, ethnicity, religion, color, gender, disability, marital status, sexual orientation, national origin, cultural differences, ancestry, physical appearance, arrest record or conviction record, military participation or membership in the national guard, state defense force or any other reserve component of the military forces of the United States, or political beliefs. Such equal opportunity shall include, but not be limited to, the following: employment, upgrading, demotion, transfer, recruitment, advertising, layoff, termination, training, rates of pay,

and any other form of compensation. CONTRACTOR agrees to post in conspicuous places, available to all employees and applicants for employment, notices setting forth the provisions of this paragraph.

4. CONTRACTOR shall file an Affirmative Action Plan with the Dane County Contract Compliance Officer in accord with Chapter 19 of the Dane County Code of Ordinances. CONTRACTOR must file such plan within fifteen (15) business days of the effective date of this Contract. During the term of this Contract CONTRACTOR shall also provide copies of all announcements of employment opportunities to COUNTY'S Contract Compliance Office, and shall report annually the number of persons, by race, ethnicity, gender, and disability status, which apply for employment and, similarly classified, the number hired and number rejected.

5. During the term of this Contract, all solicitations for employment placed on CONTRACTOR'S behalf shall include a statement to the effect that CONTRACTOR is an "Equal Opportunity Employer".

6. CONTRACTOR agrees to furnish all information and reports required by COUNTY'S Contract Compliance Officer as the same relate to affirmative action and nondiscrimination, which may include any books, records, or accounts deemed appropriate to determine compliance with Chapter 19, Dane County Code of Ordinances, and the provisions of this Contract.

7. This Contract is intended to be a Contract solely between the parties hereto and for their benefit only. No part of this Contract shall be construed to add to, supplement, amend, abridge or repeal existing rights, benefits or privileges of any third party or parties including, but not limited to, employees of either of the parties.

8. The entire agreement of the parties is contained herein and this Contract supersedes any and all oral agreements and negotiations between the parties relating to the subject matter hereof. The parties expressly agree that the express terms of this Contract shall not be amended in any fashion except in writing, executed by both parties.

9. CONTRACTOR must be pre-qualified as a Best Value Contractor with Dane County Public Works Engineering Division before award of Contract. Subcontractors must be pre-qualified ten (10) business days prior to commencing Work under this Contract.

AIA[®] Document A310[™] – 2010

Bid Bond

CONTRACTOR:

(Name, legal status and address)

SURETY:

(Name, legal status and principal place of business)

OWNER:

(Name, legal status and address)

BOND AMOUNT:**PROJECT:**

(Name, location or address, and Project number, if any)

This document has important legal consequences. Consultation with an attorney is encouraged with respect to its completion or modification.

Any singular reference to Contractor, Surety, Owner or other party shall be considered plural where applicable.

The Contractor and Surety are bound to the Owner in the amount set forth above, for the payment of which the Contractor and Surety bind themselves, their heirs, executors, administrators, successors and assigns, jointly and severally, as provided herein. The conditions of this Bond are such that if the Owner accepts the bid of the Contractor within the time specified in the bid documents, or within such time period as may be agreed to by the Owner and Contractor, and the Contractor either (1) enters into a contract with the Owner in accordance with the terms of such bid, and gives such bond or bonds as may be specified in the bidding or Contract Documents, with a surety admitted in the jurisdiction of the Project and otherwise acceptable to the Owner, for the faithful performance of such Contract and for the prompt payment of labor and material furnished in the prosecution thereof; or (2) pays to the Owner the difference, not to exceed the amount of this Bond, between the amount specified in said bid and such larger amount for which the Owner may in good faith contract with another party to perform the work covered by said bid, then this obligation shall be null and void, otherwise to remain in full force and effect. The Surety hereby waives any notice of an agreement between the Owner and Contractor to extend the time in which the Owner may accept the bid. Waiver of notice by the Surety shall not apply to any extension exceeding sixty (60) days in the aggregate beyond the time for acceptance of bids specified in the bid documents, and the Owner and Contractor shall obtain the Surety's consent for an extension beyond sixty (60) days.

If this Bond is issued in connection with a subcontractor's bid to a Contractor, the term Contractor in this Bond shall be deemed to be Subcontractor and the term Owner shall be deemed to be Contractor.

When this Bond has been furnished to comply with a statutory or other legal requirement in the location of the Project, any provision in this Bond conflicting with said statutory or legal requirement shall be deemed deleted herefrom and provisions conforming to such statutory or other legal requirement shall be deemed incorporated herein. When so furnished, the intent is that this Bond shall be construed as a statutory bond and not as a common law bond.

Signed and sealed this _____ day of _____

_____	(Contractor as Principal)	(Seal)
(Witness)	_____	(Title)
_____	(Surety)	(Seal)
(Witness)	_____	(Title)

CAUTION: You should sign an original AIA Contract Document, on which this text appears in RED. An original assures that changes will not be obscured.

AIA[®] Document A312[™] – 2010

Performance Bond

CONTRACTOR:

(Name, legal status and address)

SURETY:

(Name, legal status and principal place of business)

OWNER:

(Name, legal status and address)

CONSTRUCTION CONTRACT

Date:

Amount:

Description:

(Name and location)

BOND

Date:

(Not earlier than Construction Contract Date)

Amount:

Modifications to this Bond: None See Section 16

CONTRACTOR AS PRINCIPAL

Company: (Corporate Seal)

SURETY

Company: (Corporate Seal)

Signature: _____

Name and Title: _____

(Any additional signatures appear on the last page of this Performance Bond.)

Signature: _____

Name and Title: _____

(FOR INFORMATION ONLY — Name, address and telephone)

AGENT or BROKER:

OWNER'S REPRESENTATIVE:

(Architect, Engineer or other party:)

This document has important legal consequences. Consultation with an attorney is encouraged with respect to its completion or modification.

Any singular reference to Contractor, Surety, Owner or other party shall be considered plural where applicable.

AIA Document A312–2010 combines two separate bonds, a Performance Bond and a Payment Bond, into one form. This is not a single combined Performance and Payment Bond.

§ 1 The Contractor and Surety, jointly and severally, bind themselves, their heirs, executors, administrators, successors and assigns to the Owner for the performance of the Construction Contract, which is incorporated herein by reference.

§ 2 If the Contractor performs the Construction Contract, the Surety and the Contractor shall have no obligation under this Bond, except when applicable to participate in a conference as provided in Section 3.

§ 3 If there is no Owner Default under the Construction Contract, the Surety's obligation under this Bond shall arise after

- .1 the Owner first provides notice to the Contractor and the Surety that the Owner is considering declaring a Contractor Default. Such notice shall indicate whether the Owner is requesting a conference among the Owner, Contractor and Surety to discuss the Contractor's performance. If the Owner does not request a conference, the Surety may, within five (5) business days after receipt of the Owner's notice, request such a conference. If the Surety timely requests a conference, the Owner shall attend. Unless the Owner agrees otherwise, any conference requested under this Section 3.1 shall be held within ten (10) business days of the Surety's receipt of the Owner's notice. If the Owner, the Contractor and the Surety agree, the Contractor shall be allowed a reasonable time to perform the Construction Contract, but such an agreement shall not waive the Owner's right, if any, subsequently to declare a Contractor Default;
- .2 the Owner declares a Contractor Default, terminates the Construction Contract and notifies the Surety; and
- .3 the Owner has agreed to pay the Balance of the Contract Price in accordance with the terms of the Construction Contract to the Surety or to a contractor selected to perform the Construction Contract.

§ 4 Failure on the part of the Owner to comply with the notice requirement in Section 3.1 shall not constitute a failure to comply with a condition precedent to the Surety's obligations, or release the Surety from its obligations, except to the extent the Surety demonstrates actual prejudice.

§ 5 When the Owner has satisfied the conditions of Section 3, the Surety shall promptly and at the Surety's expense take one of the following actions:

§ 5.1 Arrange for the Contractor, with the consent of the Owner, to perform and complete the Construction Contract;

§ 5.2 Undertake to perform and complete the Construction Contract itself, through its agents or independent contractors;

§ 5.3 Obtain bids or negotiated proposals from qualified contractors acceptable to the Owner for a contract for performance and completion of the Construction Contract, arrange for a contract to be prepared for execution by the Owner and a contractor selected with the Owner's concurrence, to be secured with performance and payment bonds executed by a qualified surety equivalent to the bonds issued on the Construction Contract, and pay to the Owner the amount of damages as described in Section 7 in excess of the Balance of the Contract Price incurred by the Owner as a result of the Contractor Default; or

§ 5.4 Waive its right to perform and complete, arrange for completion, or obtain a new contractor and with reasonable promptness under the circumstances:

- .1 After investigation, determine the amount for which it may be liable to the Owner and, as soon as practicable after the amount is determined, make payment to the Owner; or
- .2 Deny liability in whole or in part and notify the Owner, citing the reasons for denial.

§ 6 If the Surety does not proceed as provided in Section 5 with reasonable promptness, the Surety shall be deemed to be in default on this Bond seven days after receipt of an additional written notice from the Owner to the Surety demanding that the Surety perform its obligations under this Bond, and the Owner shall be entitled to enforce any remedy available to the Owner. If the Surety proceeds as provided in Section 5.4, and the Owner refuses the payment or the Surety has denied liability, in whole or in part, without further notice the Owner shall be entitled to enforce any remedy available to the Owner.

§ 7 If the Surety elects to act under Section 5.1, 5.2 or 5.3, then the responsibilities of the Surety to the Owner shall not be greater than those of the Contractor under the Construction Contract, and the responsibilities of the Owner to the Surety shall not be greater than those of the Owner under the Construction Contract. Subject to the commitment by the Owner to pay the Balance of the Contract Price, the Surety is obligated, without duplication, for

- .1 the responsibilities of the Contractor for correction of defective work and completion of the Construction Contract;
- .2 additional legal, design professional and delay costs resulting from the Contractor's Default, and resulting from the actions or failure to act of the Surety under Section 5; and
- .3 liquidated damages, or if no liquidated damages are specified in the Construction Contract, actual damages caused by delayed performance or non-performance of the Contractor.

§ 8 If the Surety elects to act under Section 5.1, 5.3 or 5.4, the Surety's liability is limited to the amount of this Bond.

§ 9 The Surety shall not be liable to the Owner or others for obligations of the Contractor that are unrelated to the Construction Contract, and the Balance of the Contract Price shall not be reduced or set off on account of any such unrelated obligations. No right of action shall accrue on this Bond to any person or entity other than the Owner or its heirs, executors, administrators, successors and assigns.

§ 10 The Surety hereby waives notice of any change, including changes of time, to the Construction Contract or to related subcontracts, purchase orders and other obligations.

§ 11 Any proceeding, legal or equitable, under this Bond may be instituted in any court of competent jurisdiction in the location in which the work or part of the work is located and shall be instituted within two years after a declaration of Contractor Default or within two years after the Contractor ceased working or within two years after the Surety refuses or fails to perform its obligations under this Bond, whichever occurs first. If the provisions of this Paragraph are void or prohibited by law, the minimum period of limitation available to sureties as a defense in the jurisdiction of the suit shall be applicable.

§ 12 Notice to the Surety, the Owner or the Contractor shall be mailed or delivered to the address shown on the page on which their signature appears.

§ 13 When this Bond has been furnished to comply with a statutory or other legal requirement in the location where the construction was to be performed, any provision in this Bond conflicting with said statutory or legal requirement shall be deemed deleted herefrom and provisions conforming to such statutory or other legal requirement shall be deemed incorporated herein. When so furnished, the intent is that this Bond shall be construed as a statutory bond and not as a common law bond.

§ 14 Definitions

§ 14.1 **Balance of the Contract Price.** The total amount payable by the Owner to the Contractor under the Construction Contract after all proper adjustments have been made, including allowance to the Contractor of any amounts received or to be received by the Owner in settlement of insurance or other claims for damages to which the Contractor is entitled, reduced by all valid and proper payments made to or on behalf of the Contractor under the Construction Contract.

§ 14.2 **Construction Contract.** The agreement between the Owner and Contractor identified on the cover page, including all Contract Documents and changes made to the agreement and the Contract Documents.

§ 14.3 **Contractor Default.** Failure of the Contractor, which has not been remedied or waived, to perform or otherwise to comply with a material term of the Construction Contract.

§ 14.4 **Owner Default.** Failure of the Owner, which has not been remedied or waived, to pay the Contractor as required under the Construction Contract or to perform and complete or comply with the other material terms of the Construction Contract.

§ 14.5 **Contract Documents.** All the documents that comprise the agreement between the Owner and Contractor.

§ 15 If this Bond is issued for an agreement between a Contractor and subcontractor, the term Contractor in this Bond shall be deemed to be Subcontractor and the term Owner shall be deemed to be Contractor.

§ 16 Modifications to this bond are as follows:

Sample

(Space is provided below for additional signatures of added parties, other than those appearing on the cover page.)

CONTRACTOR AS PRINCIPAL

SURETY

Company: _____

(Corporate Seal)

Company: _____

(Corporate Seal)

Signature: _____
Name and Title: _____
Address _____

Signature: _____
Name and Title: _____
Address _____

CAUTION: You should sign an original AIA Contract Document, on which this text appears in RED. An original assures that changes will not be obscured.



AIA® Document A312™ – 2010

Payment Bond

CONTRACTOR:

(Name, legal status and address)

SURETY:

(Name, legal status and principal place of business)

OWNER:

(Name, legal status and address)

This document has important legal consequences. Consultation with an attorney is encouraged with respect to its completion or modification.

Any singular reference to Contractor, Surety, Owner or other party shall be considered plural where applicable.

AIA Document A312–2010 combines two separate bonds, a Performance Bond and a Payment Bond, into one form. This is not a single combined Performance and Payment Bond.

CONSTRUCTION CONTRACT

Date:

Amount:

Description:

(Name and location)

BOND

Date:

(Not earlier than Construction Contract Date)

Amount:

Modifications to this Bond: None See Section 18

CONTRACTOR AS PRINCIPAL

Company: *(Corporate Seal)*

SURETY

Company: *(Corporate Seal)*

Signature: _____

Name _____
and Title: _____

Signature: _____

Name _____
and Title: _____

(Any additional signatures appear on the last page of this Payment Bond.)

(FOR INFORMATION ONLY — Name, address and telephone)

AGENT or BROKER:**OWNER'S REPRESENTATIVE:**

(Architect, Engineer or other party:)

§ 1 The Contractor and Surety, jointly and severally, bind themselves, their heirs, executors, administrators, successors and assigns to the Owner to pay for labor, materials and equipment furnished for use in the performance of the Construction Contract, which is incorporated herein by reference, subject to the following terms.

§ 2 If the Contractor promptly makes payment of all sums due to Claimants, and defends, indemnifies and holds harmless the Owner from claims, demands, liens or suits by any person or entity seeking payment for labor, materials or equipment furnished for use in the performance of the Construction Contract, then the Surety and the Contractor shall have no obligation under this Bond.

§ 3 If there is no Owner Default under the Construction Contract, the Surety's obligation to the Owner under this Bond shall arise after the Owner has promptly notified the Contractor and the Surety (at the address described in Section 13) of claims, demands, liens or suits against the Owner or the Owner's property by any person or entity seeking payment for labor, materials or equipment furnished for use in the performance of the Construction Contract and tendered defense of such claims, demands, liens or suits to the Contractor and the Surety.

§ 4 When the Owner has satisfied the conditions in Section 3, the Surety shall promptly and at the Surety's expense defend, indemnify and hold harmless the Owner against a duly tendered claim, demand, lien or suit.

§ 5 The Surety's obligations to a Claimant under this Bond shall arise after the following:

§ 5.1 Claimants, who do not have a direct contract with the Contractor,

- .1 have furnished a written notice of non-payment to the Contractor, stating with substantial accuracy the amount claimed and the name of the party to whom the materials were, or equipment was, furnished or supplied or for whom the labor was done or performed, within ninety (90) days after having last performed labor or last furnished materials or equipment included in the Claim; and
- .2 have sent a Claim to the Surety (at the address described in Section 13).

§ 5.2 Claimants, who are employed by or have a direct contract with the Contractor, have sent a Claim to the Surety (at the address described in Section 13).

§ 6 If a notice of non-payment required by Section 5.1.1 is given by the Owner to the Contractor, that is sufficient to satisfy a Claimant's obligation to furnish a written notice of non-payment under Section 5.1.1.

§ 7 When a Claimant has satisfied the conditions of Sections 5.1 or 5.2, whichever is applicable, the Surety shall promptly and at the Surety's expense take the following actions:

§ 7.1 Send an answer to the Claimant, with a copy to the Owner, within sixty (60) days after receipt of the Claim, stating the amounts that are undisputed and the basis for challenging any amounts that are disputed; and

§ 7.2 Pay or arrange for payment of any undisputed amounts.

§ 7.3 The Surety's failure to discharge its obligations under Section 7.1 or Section 7.2 shall not be deemed to constitute a waiver of defenses the Surety or Contractor may have or acquire as to a Claim, except as to undisputed amounts for which the Surety and Claimant have reached agreement. If, however, the Surety fails to discharge its obligations under Section 7.1 or Section 7.2, the Surety shall indemnify the Claimant for the reasonable attorney's fees the Claimant incurs thereafter to recover any sums found to be due and owing to the Claimant.

§ 8 The Surety's total obligation shall not exceed the amount of this Bond, plus the amount of reasonable attorney's fees provided under Section 7.3, and the amount of this Bond shall be credited for any payments made in good faith by the Surety.

§ 9 Amounts owed by the Owner to the Contractor under the Construction Contract shall be used for the performance of the Construction Contract and to satisfy claims, if any, under any construction performance bond. By the Contractor furnishing and the Owner accepting this Bond, they agree that all funds earned by the Contractor in the performance of the Construction Contract are dedicated to satisfy obligations of the Contractor and Surety under this Bond, subject to the Owner's priority to use the funds for the completion of the work.

§ 10 The Surety shall not be liable to the Owner, Claimants or others for obligations of the Contractor that are unrelated to the Construction Contract. The Owner shall not be liable for the payment of any costs or expenses of any Claimant under this Bond, and shall have under this Bond no obligation to make payments to, or give notice on behalf of, Claimants or otherwise have any obligations to Claimants under this Bond.

§ 11 The Surety hereby waives notice of any change, including changes of time, to the Construction Contract or to related subcontracts, purchase orders and other obligations.

§ 12 No suit or action shall be commenced by a Claimant under this Bond other than in a court of competent jurisdiction in the state in which the project that is the subject of the Construction Contract is located or after the expiration of one year from the date (1) on which the Claimant sent a Claim to the Surety pursuant to Section 5.1.2 or 5.2, or (2) on which the last labor or service was performed by anyone or the last materials or equipment were furnished by anyone under the Construction Contract, whichever of (1) or (2) first occurs. If the provisions of this Paragraph are void or prohibited by law, the minimum period of limitation available to sureties as a defense in the jurisdiction of the suit shall be applicable.

§ 13 Notice and Claims to the Surety, the Owner or the Contractor shall be mailed or delivered to the address shown on the page on which their signature appears. Actual receipt of notice or Claims, however accomplished, shall be sufficient compliance as of the date received.

§ 14 When this Bond has been furnished to comply with a statutory or other legal requirement in the location where the construction was to be performed, any provision in this Bond conflicting with said statutory or legal requirement shall be deemed deleted herefrom and provisions conforming to such statutory or other legal requirement shall be deemed incorporated herein. When so furnished, the intent is that this Bond shall be construed as a statutory bond and not as a common law bond.

§ 15 Upon request by any person or entity appearing to be a potential beneficiary of this Bond, the Contractor and Owner shall promptly furnish a copy of this Bond or shall permit a copy to be made.

§ 16 Definitions

§ 16.1 Claim. A written statement by the Claimant including at a minimum:

- .1 the name of the Claimant;
- .2 the name of the person for whom the labor was done, or materials or equipment furnished;
- .3 a copy of the agreement or purchase order pursuant to which labor, materials or equipment was furnished for use in the performance of the Construction Contract;
- .4 a brief description of the labor, materials or equipment furnished;
- .5 the date on which the Claimant last performed labor or last furnished materials or equipment for use in the performance of the Construction Contract;
- .6 the total amount earned by the Claimant for labor, materials or equipment furnished as of the date of the Claim;
- .7 the total amount of previous payments received by the Claimant; and
- .8 the total amount due and unpaid to the Claimant for labor, materials or equipment furnished as of the date of the Claim.

§ 16.2 Claimant. An individual or entity having a direct contract with the Contractor or with a subcontractor of the Contractor to furnish labor, materials or equipment for use in the performance of the Construction Contract. The term Claimant also includes any individual or entity that has rightfully asserted a claim under an applicable mechanic's lien or similar statute against the real property upon which the Project is located. The intent of this Bond shall be to include without limitation in the terms "labor, materials or equipment" that part of water, gas, power, light, heat, oil, gasoline, telephone service or rental equipment used in the Construction Contract, architectural and engineering services required for performance of the work of the Contractor and the Contractor's subcontractors, and all other items for which a mechanic's lien may be asserted in the jurisdiction where the labor, materials or equipment were furnished.

§ 16.3 Construction Contract. The agreement between the Owner and Contractor identified on the cover page, including all Contract Documents and all changes made to the agreement and the Contract Documents.

§ 16.4 **Owner Default.** Failure of the Owner, which has not been remedied or waived, to pay the Contractor as required under the Construction Contract or to perform and complete or comply with the other material terms of the Construction Contract.

§ 16.5 **Contract Documents.** All the documents that comprise the agreement between the Owner and Contractor.

§ 17 If this Bond is issued for an agreement between a Contractor and subcontractor, the term Contractor in this Bond shall be deemed to be Subcontractor and the term Owner shall be deemed to be Contractor.

§ 18 Modifications to this bond are as follows:

(Space is provided below for additional signatures of added parties, other than those appearing on the cover page.)

CONTRACTOR AS PRINCIPAL

Company: _____

(Corporate Seal)

SURETY

Company: _____

(Corporate Seal)

Signature: _____

Name and Title: _____

Address _____

Signature: _____

Name and Title: _____

Address _____

CAUTION: You should sign an original AIA Contract Document, on which this text appears in RED. An original assures that changes will not be obscured.

CONDITIONS OF CONTRACT

TABLE OF CONTENTS

1. BIDS AND QUOTATIONS	Error! Bookmark not defined.
2. GUARANTEE AND BOND	2
3. SHOP DRAWINGS, PRODUCT DATA AND SAMPLES	3
4. AWARDS	4
5. CONTRACT PROVISIONS	Error! Bookmark not defined.
6. GENERAL GUARANTEE.....	9
7. IDENTICAL BIDDING.....	10
8. BINDING CONTRACTS	10
9. AFFIRMATIVE ACTION PROVISION AND MINORITY / WOMEN / DISADVANTAGED BUSINESS ENTERPRISES	10
10. COMPLIANCE WITH FAIR LABOR STANDARDS	11
11. DOMESTIC PARTNERSHIP BENEFITS	11
12. INSURANCE REQUIREMENTS	11

1. BIDS AND QUOTATIONS

- A. **Addressing of Bids.** Bids shall be addressed to attention of Public Works Engineering Division and received at Dane County Department of Public Works, Highway & Transportation, 1919 Alliant Energy Center Way, Madison, WI 53713, on or before local time and date specified herein for Bid Due Date. Seal all bids in envelopes and clearly mark front with bid number and reference to specified contents of bid. All uses of term “County” in Construction Documents shall mean Dane County.
- B. **Only One Copy Required.** Unless otherwise specified, only one copy of bid or quotation on prescribed Bid Form will be required.
- C. **Additional Data with Bid.** Bidder may submit, on firm’s letterhead only, additional data and information deemed advantageous to County. County shall hold optional consideration of such data and information.
- D. **More than One Bid.** Bidders desiring to submit more than one bid may do so provided such additional bid or bids are properly submitted on Dane County Department of Public Works, Highway & Transportation’s Bid Form. Obtain extra sets of Construction Documents from Dane County Department of Public Works, Highway & Transportation. All uses of term “Department” in Construction Documents shall mean Department of Public Works, Highway & Transportation, which is Dane County government unit.
- E. **Withdrawal or Late Bids.** County will not accept formal bids, amendments thereto, or requests for withdrawal of bid or any part thereof, after time of Bid Due Date.
- F. **Preparation and Submission.** All written bids, unless otherwise provided for, must be submitted on and in accordance with forms provided by County properly signed in ink. Bids not signed by hand are not accepted. Bidders must register in advance with Purchasing Division.
- G. **Products by Name.** Intention of Specifications of products by name is to be descriptive of quality, workmanship, finish, function and approximate characteristics desired; intention is not necessarily restriction. Consideration of products substitution for those named is possible, provided substitute offered is, in opinion of Dane County Public Works Project

Manager, equal or superior in quality, workmanship, finish, function and approximate characteristics to that specified in Project Manual Specifications listed herein.

- H. **Visitation of Sites.** Bidder shall visit site(s) that will receive intended work or installation, and in so doing, be held responsible for job deemed satisfactory by County after completion of the Work or installation. No additional compensation shall be allowed for any condition of which bidder could have been informed.
- I. **Completeness.** Supply all information required by Construction Documents to constitute regular bid. This shall include:
 - 1. Completed Bid Form.
 - 2. Completed Fair Labor Practices Certification.
 - 3. Completed Bid Bond.
- J. **Bids Binding Sixty (60) Calendar Days.** Unless otherwise specified all formal bids submitted shall be binding for sixty (60) calendar days following Bid Due Date.
- K. **Conditional Bids.** Qualified bids are subject to complete rejection, or partial rejection.
- L. **All or Part.** Bids or quotations may be considered and award made for all or any part of total quantities as specified in Construction Documents.
- M. **Errors.** Unit bid price shall govern when extending total prices has errors. Carelessness in quoting prices or in preparation of bid otherwise, will not relieve bidder. Explain all erasures in bids and include signature of bidder.
- N. **Regulation by State Statutes.** Bidding and letting of contracts are subject to provisions of Wisconsin Statutes 59.52(29) and 66.0901 and all subsequent sections and amendments thereof.
- O. **Bidders Present.** Bid Due Date is time fixed for opening of formal bids. Bids' contents will be made public for information of bidders and others properly interested, who may be present either in person or by representative. Bidders are encouraged to attend all openings, and to offer constructive suggestions for improvements to bid format or ways in which County can realize greater savings.
- P. **Taxes.** Contractor shall pay applicable State and local sales taxes.

2. GUARANTEE AND BOND

- A. **Bid Bond / Guarantee.** Bid Bond shall accompany Bids, which shall be either flat sum or percentage figure as shown on Project Manual Cover. This Bid Bond shall serve as warrant that successful bidder will fulfill terms of bid within time limit as indicated in bid after notice of award by Dane County. Bid Bond may be certified bank check (note: uncertified checks will not be acceptable), cashier's check or United State money order payable to Treasurer of Dane County; or on Bid Bond with corporate surety authorized to do business in State of Wisconsin and warranty of attorney to confess judgment thereon attached thereto. County will return negotiable Bid Bonds to unsuccessful bidders after awarding of bid. County shall return check held from Contractor after satisfactory completion of Contract or after receipt by County of Performance Bond from Contractor, if one is required. Surety Bid Bonds will not be returned unless specifically requested by individual bidders.

- B. **Guarantor Liability.** When guarantee is required, failure of bidder to furnish acceptable Performance Bond (Article 2.C.) within twenty (20) business days after receipt of notice of award shall render guarantor liable to County. Bids covered by certified check or bond such security shall become absolute property of County and shall be deposited with County Treasurer for benefit of County as liquidated damages. County shall forthwith proceed to collect on Bid Bond.
- C. **Performance / Payment Bond.** When required, file guarantee that successful bidder will faithfully perform obligations of bid as accepted. Such guarantee must be bond complying with Wisconsin Statute 779.14 with corporate surety authorized to do business in this State, and that Contractor or subcontractors will be responsible for all claims for injuries to persons or damages to property or premises arising out of or in connection with their operations prior to acceptance of finished work or supplies, and that they will promptly make payments to all persons supplying them with labor or materials in execution of the Work provided for in Contract; guarantee to indemnify, hold harmless and defend Dane County, its boards, commissions, agencies, officers, employees and representatives from all costs, damages and expenses growing out of or by reason of successful bidder's failure to comply and perform the Work and complete Contract in accordance with Construction Documents; attach thereto a warrant of attorney authorizing confession of judgment thereon for benefit of County.

3. SHOP DRAWINGS, PRODUCT DATA AND SAMPLES

- A. Shop Drawings are drawings, diagrams, schedules and other data specially prepared for the Work by Contractor or subcontractor, sub-subcontractor, manufacturer, supplier or distributor to illustrate some portion of the Work.
- B. Product Data are illustrations, standard schedules, performance charts, instructions, brochures, diagrams and other information furnished by Contractor to illustrate materials or equipment for some portion of the Work.
- C. Samples are physical examples that illustrate materials, equipment or workmanship and establish standards to compare the Work.
- D. Shop Drawings, Product Data, Samples and similar submittals are not Construction Documents. Purpose of their submittal is to demonstrate for those portions of the Work for which submittals are required how Contractor proposes to conform to information given and design concept expressed in Construction Documents.
- E. Contractor shall review, approve and submit to Public Works Project Manager Shop Drawings, Product Data, Samples and similar submittals required by Construction Documents with reasonable promptness and in such sequence as to cause no delay in the Work or in activities of County or of separate contractors. Submittals made by Contractor not required by Construction Documents, may be returned without action.
- F. Contractor shall perform no portion of the Work requiring submittal and review of Shop Drawings, Product Data, Samples or similar submittals until Public Works Project Manager has approved respective submittal. Such Work shall be in accordance with approved submittals.
- G. By approving and submitting, Shop Drawings, Product Data, Samples and similar submittals, Contractor represents that Contractor has determined and verified materials, field measurements and field construction criteria related thereto, or will do so, and has checked

and coordinated information contained within such submittals with requirements of the Work and of Construction Documents.

- H. Contractor shall not be relieved of responsibility for deviations from requirements of Construction Documents by Public Works Project Manager's approval of Shop Drawings, Product Data, Samples and similar submittals unless Contractor has specifically informed Public Works Project Manager in writing of such deviation at time of submittal and Public Works Project Manager has given written approval to specific deviation. Contractor shall not be relieved of responsibility for errors or omissions in Shop Drawings, Product Data, Sample or similar submittals by Public Works Project Manager's approval thereof.
- I. Contractor shall in writing direct specific attention to revised and / or resubmitted Shop Drawings, Product Data, Samples or similar submittals that were not requested by Architect / Engineer or Public Works Project Manager on previous submittals.
- J. Unless specified otherwise, Contractor shall submit three (3) copies of all Shop Drawings, Product Data, Samples or similar submittals for each submission, until receiving final approval. After final approval, provide five (5) additional copies for distribution and such other copies as may be required.

4. AWARDS

- A. **Lowest Responsible Bidder.** Award will be to lowest responsible bidder conforming to Construction Documents or on most advantageous bid to County.
- B. **Other Considerations.** Quantities involved, time of delivery, purpose for which required, competency of bidder, ability to render satisfactory service and past performance will be considered in determining responsibility.
- C. **Rejection of Bids.** County reserves right to reject any or all bids or quotations in whole or in part and to award by items, parts of items, or by any aggregate group of items specified. County also reserves right to waive technical defects when in its judgment best interests of County thereby will be served.
- D. **Notice of Acceptance.** Sufficient notification of acceptance of bid will be written notice of award to bidder in form of Purchase Order or similar, mailed or delivered to address shown on Bid Form.
- E. **Tie Bids.** If two or more bidders submit identical bids, decision of County to make award to one or more of such bidders shall be final. Cash discount will be taken into consideration in determining award. Also, see Article 7.A. IDENTICAL BIDDING, Antitrust Laws.
- F. **Qualifying Bidders.** Prior to solicitation and / or awarding of bid, County may require submission by bidder of complete financial statement and questionnaire describing bidder's financial ability and experience in performance of similar work. Refer to Instructions to Bidders.
- G. **Disqualification.** Awards will not be made to any person, firm or company in default of Contract with County, or to any bidder having as its sales agent or representative or as member of firm, any individual previously in default or guilty of misrepresentation.
- H. **Bid Results.** Bidders may secure information pertaining to results of bids by visiting Public Works' website, bids-pwht.countyofdane.com/.

5. CONTRACT PROVISIONS

- A. **Acceptance Constitutes Contract.** Written acceptance by Public Works Project Manager of proposal for services shall constitute Contract, which shall bind bidder to perform the Work as detailed in Construction Documents, for bid amount and in accordance with all conditions of said accepted bid. Formal Contract containing all provisions of Contract signed by both parties shall be used when required by Public Works Project Manager.
- B. **Local Restrictions and Permits.** All work shall be done according to applicable laws, ordinances and codes. Contractor shall procure and pay for all required permits for permanent or temporary work.
- C. **Payment of Invoices.** Payment may be made only after inspection and acceptance by using agency and approval by Dane County Public Works Project Manager, and, where required by ordinances, approval by Dane County Board of Supervisors. If materials or equipment were delivered, constructed, erected, installed or tested on site, payment shall be made based on ninety-five percent (95%) of value of all the Work performed up to fifty percent (50%) of scheduled values less total of previous payments. Authorized extra work will be included in progress payments. Payment of balances will be made only after approval and final acceptance by County in consideration and elimination of possibilities of imperfect work, faulty materials or equipment, liens that have been filed, or if evidence indicates possible filing of claims.
- D. **Contract Alterations.** No alterations or variables in terms of contract shall be valid or binding upon County unless made in writing and signed by Purchasing Agent or authorized agent.
- E. **Assignments.** No contract may be assigned, sublet or transferred without written consent of Public Works Project Manager.
- F. **Cancellations.** Contract may be canceled or voided by Public Works Project Manager upon non-performance or violation of contract provisions, and award made to next low bidder or articles specified may be purchased on open market. In either event, defaulting contractor (or their surety) shall be liable to Dane County for costs to County in excess of defaulting contractor's contract prices.
- G. **Right of Department to Terminate Contract.**
1. In event that Contractor or any subcontractors violate any provisions of this Contract, County may serve written notice upon Contractor and Surety of its intention to terminate Contract. Such notice to contain reasons for such intention to terminate Contract, and unless within ten (10) business days after serving of such notice upon Contractor, such violation or delay shall cease and satisfactory arrangement or correction be made, Contract shall, upon expiration of said ten (10) business days, cease and terminate.
 2. In event of any such termination, County shall immediately serve notice thereof upon Surety and Contractor, and Surety shall have right to take over and perform Contract subject to County's approval. However, if Surety does not commence performance thereof within ten (10) business days from date of mailing to such Surety of notice of termination, County may take over the Work and prosecute same to completion by Contract or by force account for account and at expense of Contractor. Contractor and Surety shall be liable to County for any excess cost occasioned County thereby, and in such event County may take possession of and utilize in completing the Work, such

equipment, materials and / or supplies as may be on site of the Work and therefore necessary.

- H. **Non-Liability.** Contractor shall not be liable in damages for delay in shipment or failure to deliver when such delay or failure is result of fire, flood, strike, transporting carrier, act of God, act of government, act of alien enemy or by any other circumstances which, in Public Works Project Manager's opinion, is beyond control of Contractor. Under such circumstances, however, Public Works Project Manager may in discretion, cancel Contract.
- I. **Quality Assurance.** Inspection of equipment, materials and / or supplies shall be made by or at direction of County or Agency to which goods are delivered, and any articles supplied that are defective, or fails in any way to meet Specifications or other requirements of Contract, will be rejected. Public Works Project Manager shall direct all required laboratory tests. Decision of Public Works Project Manager on acceptance shall be final.
- J. **Time for Completion.** Contractor agrees that the Work shall be prosecuted regularly and diligently and complete entire project as stated in Construction Documents.
- K. **Changes in the Work.**
1. Except in cases of emergency, no changes in the Work covered by approved Construction Documents shall be made without having prior written approval of Department. Charges or credits for work covered by approved change shall be determined by one of these methods:
 - a) Unit bid prices previously approved.
 - b) Agreed lump sum based on actual cost of:
 - 1) Labor, including foremen, and all fringe benefits that are associated with their wages;
 - 2) Materials entering permanently into the Work;
 - 3) Ownership or rental cost of construction plant and equipment during time of use on extra work;
 - 4) Power and consumable supplies for operation of construction or power equipment;
 - 5) Workmen's Compensation Insurance, Contractor's Public Liability and Property Damage Insurance, and Comprehensive Automobile Liability Insurance;
 - 6) Social Security, pension and unemployment contributions;
 - 7) To cost under K.1.b), there shall be added fixed fee to be agreed upon, but not to exceed fifteen percent (15%) of actual cost of the Work performed with their own labor force; fee shall be compensation to cover cost of supervision, overhead, bond, profit and any other general expense;
 - 8) On that portion of work under K.1.b) done under subcontract, Contractor may include not over seven and one-half percent (7½%) for supervision, overhead, bond, profit and any other general expense; and
 - 9) Contractor shall keep and present in such form as directed, correct amount of cost together with such supporting vouchers as may be required by Department.
 - c) Cost-Plus Work, with not-to-exceed dollar limit, based on actual cost of:
 - 1) Labor, including foremen, and all fringe benefits that are associated with their wages;
 - 2) Materials entering permanently into the Work;
 - 3) Ownership or rental cost of construction plant and equipment during time of use on extra work. (Rental cost cannot exceed fifty percent (50%) replacement value of rented equipment);
 - 4) Power and consumable supplies for operation of construction or power equipment;

- 5) Workmen's Compensation, Contractor's Public Liability and Property Damage Insurance, and Comprehensive Automobile Liability Insurance;
 - 6) Social Security, pension and unemployment contributions;
 - 7) To cost under K.1.c) there shall be added fixed fee to be agreed upon, but not to exceed fifteen percent (15%) of actual cost of the Work performed with their own labor force; fee shall be compensation to cover cost of supervision, overhead, bond, profit, and any other general expense;
 - 8) On that portion of work under K.1.c) done under subcontract, Contractor may include not over seven and one-half percent (7½%) for supervision, overhead, bond, profit, and any other general expense; and
 - 9) Contractor shall keep and present in such form as directed, correct amount of cost together with such supporting vouchers as may be required by Department.
2. If Contractor claims that by any instructions given by Architect / Engineer, Department, by drawings or otherwise, regarding performance of the Work or furnishing of material under Contract, involves extra cost, Contractor shall give Department written notice thereof within two weeks after receipt of such instructions and in any event before proceeding to execute work, unless delay in executing work would endanger life or property.
 3. No claim for extra work or cost shall be allowed unless same was done in pursuance of written order of Architect / Engineer and approved by Department, as previously mentioned, and claim presented with payment request submitted after changed or extra work is completed.
 4. Negotiation of cost for change in the Work shall not be cause for Contractor to delay prosecution of the Work if Contractor has been authorized in writing by Public Works Project Manager to proceed.

L. Payments to Contractor.

1. County will make partial payments to Contractor for value, proportionate to amount of Contract, of all labor and material incorporated in the Work during preceding calendar month upon receipt of approved Application and Certificate of Payment from Architect / Engineer and approval of Department.
2. Contractor shall submit to Architect / Engineer Application and Certificate of Payment. Architect / Engineer will review and approve this before sending it to Public Works Project Manager. Evidence may be required, and supplied on demand, that supports request and Contractor's right to payment claimed.
3. Request for payment for preparatory work and materials delivered and suitably stored at site to be incorporated into the Work at some future period, will be given due consideration. Requests involving materials stored off site, may be rejected; however, if deemed essential for reasons of job progress, protection, or other sufficient cause, requests will be considered conditional upon submission by Contractor of bills of sale and such other procedures as will adequately protect County's interest such as storage in bonded warehouse with adequate coverage. If there is any error in payment, Contractor is obligated to notify Department immediately, but no longer than ten (10) business days from receipt of payment.
4. Payments by County will be due within forty-five (45) business days after receipt by Department of certified request.

5. Five percent (5%) of each request for certification will be retained until final completion and acceptance of all the Work covered by Contract. However, anytime after fifty percent (50%) of the Work has been furnished and installed at site, remaining payments will be made in full if Architect / Engineer and Public Works Project Manager find that progress of the Work corresponds with construction progress schedule. If Architect / Engineer and Public Works Project Manager find that progress of the Work does not correspond with construction progress schedule, up to ten percent (10%) of each request for payment may be retained for the Work completed.
6. All material and work covered by partial payments made shall become sole property of County. This provision shall not be construed as relieving Contractor from sole responsibility for care and protection of materials and work upon which payments have been made or restoration of any damaged work, or as waiver of right of County to require fulfillment of all of terms of Contract.
7. Final payment will be made within sixty (60) calendar days after final completion of the Work, and will constitute acceptance thereof. .
8. On completion and acceptance of each separate division of Contract, on which stated price is separated in Contract, payment may be made in full, including retained percentages thereon, less authorized deductions.
9. Every contractor engaged in performance of any contract for Department of Public Works, Highway & Transportation shall submit to this Department, as requested and with final application for payment for work under said contract, affidavit(s) as required to prove that all debts and claims against this Work are paid in full or otherwise satisfied, and give final evidence of release of all liens against the Work and County. Use "Dane County, Wisconsin Contractor Wage Affidavit" form included in Supplementary Conditions.

M. Withholding of Payments.

1. County, after having served written notice on said Contractor, may either pay directly any unpaid bills of which Department has written notice, or withhold from Contractor's unpaid compensation, sum of money deemed reasonably sufficient to pay any and all such lawful claims until satisfactory evidence is furnished that all liabilities have been fully discharged. Then payment to Contractor shall be resumed in accordance with terms of this Contract, but in no event shall these provisions be construed to impose any obligations upon County to either Contractor or Contractor's Surety.
2. In paying any unpaid bills of Contractor, County shall be deemed Agent of Contractor, and any payment so made by County, shall be considered as payment made under Contract by County to Contractor and County shall not be liable to Contractor for any such payment made in good faith.
3. Contractor shall indemnify, hold harmless and defend Dane County, its boards, commissions, agencies, officers, employees and representatives from all claims growing out of lawful demands of subcontractors, laborers, workmen, mechanics, material men, and furnishers of machinery and parts thereof, equipment, power tools, and all supplies, including commissary, incurred in performance of this Contract.
4. At Department's request, Contractor shall furnish satisfactory evidence that all obligations of nature designated above have been paid, discharged or waived.

N. Acceptance of Final Payment as Release.

1. Making of final payment shall constitute waiver of all claims by County except those arising from:
 - a) Unsettled lien;
 - b) Faulty or defective work appearing after substantial completion;
 - c) Failure of the Work to comply with requirements of Construction Documents; or
 - d) Terms of any special guarantees required by Construction Documents.
2. Acceptance of final payment shall constitute waiver of all claims by Contractor.

O. **Lien Waivers.** Contractor warrants that title to all work covered by application for Payment will pass to County no later than time of payment. Contractor further warrants that upon submittal of Application for Payment all work for which Certificates for Payment have been previously issued and payments received from County shall, to best of Contractor's knowledge, information and belief, be free and clear of liens, claims, security interests or encumbrances in favor of Contractor, subcontractor, material suppliers, or other persons or entities making claim by reason of having provide labor, materials and equipment related to the Work.

P. **Use and Occupancy Prior to Acceptance.** Contractor agrees to use and occupancy of portion or unit of project before formal acceptance by Department, provided Department:

1. Secures written consent of Contractor; except when in opinion of Department's Public Works Project Manager, Contractor is chargeable with unwarranted delay in final cleanup of punch list items or other Contract requirements;
2. Secures endorsement from insurance carrier and consent of Surety permitting occupancy of building or use of project during remaining period of construction, or, secures consent of Surety;
3. Assumes all costs and maintenance of heat, electricity and water; and
4. Accepts all work completed within that portion or unit of project to be occupied, at time of occupancy.

Q. **Correction of Work.**

1. All work, all materials whether incorporated in the Work or not, and all processes of manufacture shall at all times and places be subject to inspection of Architect / Engineer and Public Works Project Manager who shall be judge of quality and suitability of work, materials, and processes of manufacture for purposes for which they are used. Should they fail to meet Architect / Engineer's and Public Works Project Manager's approval they shall be reconstructed, made good, replaced or corrected, as case may be, by Contractor at Contractor's expense. Rejected material shall immediately be removed from site.
2. If Contractor defaults or neglects to carry out the Work in accordance with Construction Documents or fails to perform any provision of Contract, Department may, after ten (10) business days written notice to Contractor and without prejudice to any other remedy County may have, make good such deficiencies. In such case, appropriate Change Order shall be issued deducting from payments then or thereafter due Contractor cost of correcting such deficiencies, including cost of Architect / Engineer's additional services made necessary by such default, neglect or failure.

6. GENERAL GUARANTEE

A. Neither final certificate of payment nor any provision in Construction Documents nor partial or entire occupancy of premises by County shall constitute acceptance of work not done in

accordance with Construction Documents or relieve Contractor of liability in respect to any expressed warranties or responsibility for faulty materials or workmanship.

1. In no event shall making of any payment required by Contract constitute or be construed as waiver by County of any breach of covenants of Contract or waiver of any default of Contractor and making of any such payment by County while any such default or breach shall exist shall in no way impair or prejudice right of County with respect to recovery of damages or other remedy as result of such breach or default.
- B. Contractor shall remedy and make good all defective workmanship and materials and pay for any damage to other work resulting therefrom, which appear within period of one year from date of substantial completion, providing such defects are not clearly due to abuse or misuse by County. Department will give notice of observed defects with reasonable promptness.
- C. Guarantee on work executed after certified date of substantial completion will begin on date when such work is inspected and approved by Architect / Engineer and Public Works Project Manager.
- D. Where guarantees or warranties are required in sections of Construction Documents for periods in excess of one year, such longer terms shall apply; however, Contractor's Performance / Payment Bond shall not apply to any guarantee or warranty period in excess of one year.

7. IDENTICAL BIDDING

- A. **Antitrust Laws.** All identical bids submitted to County because of advertised procurement for materials, supplies, equipment or services exceeding \$1,000,000.00 in total amount shall be reported to Attorney Generals of the United States and State of Wisconsin for possible violation and enforcement of antitrust laws.

8. BINDING CONTRACTS

- A. **Contract Commitment.** Any contracts resulting from this bid shall be binding on successful bidder(s) to its conclusion and on its assigns, heirs, executors, administrators or successors.

9. AFFIRMATIVE ACTION PROVISION AND MINORITY / WOMEN / DISADVANTAGED BUSINESS ENTERPRISES

- A. **Affirmative Action Provisions.** During term of its Contract, Contractor agrees not to discriminate on basis of race, religion, color, sex, handicap, age, sexual preference, marital status, physical appearance, or national origin against any person, whether recipient of services (actual or potential), employee, or applicant for employment. Such equal opportunity shall include, but not be limited to following: employment, upgrading, demotion, transfer, recruitment, advertising, layoff, termination, training, rates of pay, and any other form of compensation or level of service(s). Contractor agrees to post in conspicuous places, available to all employees, service recipients and applicants for this paragraph. Listing of prohibited bases for discrimination shall not be construed to amend in any fashion state or federal law setting forth additional bases and exceptions shall be permitted only to extent allowable in state or federal law.
- B. Contractor is subject to this paragraph only if Contractor has ten (10) or more employees and receives \$10,000.00 or more in annual aggregate contracts with County. Contractor shall file Affirmative Action Plan with Dane County Contract Compliance Officer in accord with

Chapter 19 of Dane County Code of Ordinances. Contractor must file such plan within fifteen (15) business days of effective date of this Contract and failure to do so by that date shall constitute grounds for immediate termination of Contract. During term of this Contract, Contractor shall also provide copies of all announcements of employment opportunities to County's Contract Compliance Office, and shall report annually number of persons, by race, sex and handicap status, which apply for employment and, similarly classified, number hired and number rejected.

- C. Contact Dane County Contract Compliance Officer at Dane County Contract Compliance Office, 210 Martin Luther King, Jr. Blvd., Room 421, Madison, WI 53703, 608/266-4114.
- D. In all solicitations for employment placed on Contractor's behalf during term of this Contract, Contractor shall include statement to effect that Contractor is "Equal Opportunity Employer."
- E. Contractor agrees to furnish all information and reports required by County's Contract Compliance Officer as same relate to affirmative action and nondiscrimination, which may include any books, records, or accounts deemed appropriate to determine compliance with Chapter 19, Dane County Code of Ordinances, and provision of this Contract.
- F. **Minority / Women / Disadvantaged / Emerging Small Business Enterprises.** Chapter 19.508 of Dane County Code of Ordinances is official policy of Dane County to utilize Minority Business Enterprises (MBEs), Women Business Enterprises (WBEs), Disadvantaged Business Enterprises (DBEs) and Emerging Small Business Enterprises (ESBEs) fully.
- G. Contractor may utilize MBEs / WBEs / DBEs / ESBEs as subcontractors or suppliers. List of subcontractors will be required of low bidder as stated in this Contract. List shall indicate which subcontractors or suppliers are MBEs / WBEs / DBEs / ESBEs and what percentage of subcontract is awarded, shown as percentage of total dollar amount of bid.

10. COMPLIANCE WITH FAIR LABOR STANDARDS

- A. During term of this Contract, Contractor shall report to County Contract Compliance Officer, within ten (10) business days, any allegations to, or findings by National Labor Relations Board (NLRB) or Wisconsin Employment Relations Commission (WERC) that Contractor has violated statute or regulation regarding labor standards or relations. If investigation by Contract Compliance Officer results in final determination that matter adversely affects Contractor's responsibilities under this Contract, and which recommends termination, suspension or cancellation of this Contract, County may take such action.
- B. Contractor may appeal any adverse finding by Contract Compliance Officer as set forth in Dane County Ordinance 25.015(11)(c) through (e).
- C. Contractor shall post this statement in prominent place visible to employees: "As condition of receiving and maintaining contract with Dane County, this employer shall comply with federal, state and all other applicable laws prohibiting retaliation or union organizing."

11. DOMESTIC PARTNERSHIP BENEFITS

- A. Not Used.

12. INSURANCE REQUIREMENTS

- A. Contractor shall indemnify, hold harmless and defend Dane County, its boards, commissions, agencies, officers, employees and representatives from and against all claims, damages, losses and expenses including attorneys' fees arising out of or resulting from performance of the Work, provided that any such claim, damage, loss or expense is attributable to bodily injury, sickness, disease or death, or to injury to or destruction of tangible property (other than the Work itself) including loss of use resulting there from, and is caused in whole or in part by any act or omission of Contractor, any subcontractor, anyone directly or indirectly employed by any of them or anyone for whose acts any of them may be liable, regardless of whether or not it is caused in part by a part indemnified hereunder.
- B. In any and all claims against Dane County, its boards, commissions, agencies, officers, employees and representatives or by any employee of Contractor, any subcontractor, anyone directly or indirectly employed by any of them or anyone for whose acts any of them may be liable, indemnification obligation under this Contract shall not be limited in any way by any limitation on amount or type of damages, compensation or benefits payable by or for Contractor or any subcontractor under worker's compensation acts, disability benefits or other employee benefit acts.
- C. Obligations of Contractor under this Contract shall not extend to liability of Architect / Engineer, its agents or employees arising out of (1) preparation or approval of maps, drawings, opinion, reports, surveys, change orders, designs or specifications; or (2) giving of or failure to give directions or instruction by Architect / Engineer, its agents or employees provided such giving or failure to give is primary cause of injury or damage.
- D. County shall not be liable to Contractor for damages or delays resulting from work by third parties or by injunctions or other restraining orders obtained by third parties.
- E. **Contractor Carried Insurance.** In order to protect itself and County, Contractor shall not commence work under this Contract until obtaining all required insurance and County has approved such insurance. Contractor shall not allow any subcontractor to commence work on subcontract until insurance required of subcontractor has been so obtained and approved.
1. **Worker's Compensation Insurance**
Contractor shall procure and shall maintain during life of this Contract, Worker's Compensation Insurance as required by statute for all of its employees engaged in work at site of project under this Contract and, in case of such work sublet, Contractor shall require subcontractor similarly to provide Worker's Compensation Insurance for all of latter's employees to be engaged in such work unless such employees are covered by protection afforded by Contractor's Worker's Compensation Insurance.
 2. **Contractor's Public Liability and Property Damage Insurance**
Contractor shall procure and maintain during life of this Contract, Contractor's Public Liability Insurance and Contractor's Property Damage Insurance in amount not less than \$1,000,000.00 per occurrence for bodily injury and death, and Contractor's Property Damage Insurance in amount not less than \$1,000,000.00 and shall be primary with Dane County as "Additional Insured".
 3. **Auto Liability Insurance**
Contractor shall procure and maintain during life of this Contract, Comprehensive Automobile Liability Insurance covering owned, non-owned and hired automobiles for limits of not less than \$1,000,000.00 and shall be primary with Dane County as "Additional Insured".

- F. Contractor either (1) shall require each subcontractors to procure and to maintain during life of subcontract, subcontractor's Public Liability Property Damage Insurance, and Comprehensive Automobile Liability Insurance of type and in same amount specified in preceding paragraphs; or (2) insure that activities of subcontractors in their own policy.
- G. Contractor shall furnish County with certificates showing type, amount, class of operations covered, effective dates and dates of expiration of policies. Such certificates shall also contain substantially this statement: "Insurance covered by this certificate will not be canceled or materially altered, except after ten (10) business days written notice has been received by County."
- H. **Builder's Risk.** County shall provide Builder's Risk insurance coverage for its insurable interests in construction or renovation projects with completed value of \$1,000,000 or less. Therefore, if project completed value is more than \$1,000,000, Contractor shall obtain and maintain in force, at its own expense, Builder's Risk Insurance on all risks for amount equal to full completed value of covered structure or replacement value of alterations or additions. Any deductible shall not exceed \$25,000 for each loss. Policy shall include occupancy clause and list Dane County as loss payee.

SUPPLEMENTARY CONDITIONS

1. APPLICATION & CERTIFICATE FOR PAYMENT

- A. Every contractor engaged in performance of any contract for Department of Public Works, Highway & Transportation shall submit partial and final Application & Certificate for Payment for work under said contract. Form shall provide similar information as shown on AIA G702™ and G703™ forms (samples shown below). Forms shall be submitted to Public Works Project Manager for approval.

AIA Document G702™ – 1992

Application and Certificate for Payment

TO OWNER:	PROJECT:	APPLICATION NO:	Distribution to:
FROM CONTRACTOR:	VIA ARCHITECT:	PERIOD TO:	OWNER <input type="checkbox"/>
		CONTRACT FOR:	ARCHITECT <input type="checkbox"/>
		CONTRACT DATE:	CONTRACTOR <input type="checkbox"/>
		PROJECT NOS:	FIELD <input type="checkbox"/>
			OTHER <input type="checkbox"/>

CONTRACTOR'S APPLICATION FOR PAYMENT

Application is made for payment, as shown below, in connection with the Contract. AIA Document G703™, Continuation Sheet, is attached.

1. ORIGINAL CONTRACT SUM \$ _____

2. NET CHANGE BY CHANGE ORDERS \$ _____

3. CONTRACT SUM TO DATE (Line 1 + 2) \$ _____

4. TOTAL COMPLETED & STORED TO DATE (Column G on G703) \$ _____

5. RETAINAGE:

a. _____ % of Completed Work
(Columns D + E on G703) \$ _____

b. _____ % of Stored Material
(Column F on G703) \$ _____

Total Retainage (Lines 5a + 5b, or Total in Column I of G703) \$ _____

6. TOTAL EARNED LESS RETAINAGE \$ _____
(Line 4 minus Line 5 Total)

7. LESS PREVIOUS CERTIFICATES FOR PAYMENT \$ _____
(Line 6 from prior Certificate)

8. CURRENT PAYMENT DUE \$ _____

9. BALANCE TO FINISH, INCLUDING RETAINAGE \$ _____
(Line 3 minus Line 6)

CHANGE ORDER SUMMARY	ADDITIONS	DEDUCTIONS
Total changes approved in previous months by Owner	\$ _____	\$ _____
Total approved this month	\$ _____	\$ _____
TOTAL	\$ _____	\$ _____
NET CHANGES by Change Order	\$ _____	\$ _____

The undersigned Contractor certifies that to the best of the Contractor's knowledge, information and belief the Work covered by this Application for Payment has been completed in accordance with the Contract Documents, that all amounts have been paid by the Contractor for Work for which previous Certificates for Payment were issued and payments received from the Owner, and that current payment shown herein is now due.

CONTRACTOR:
By: _____ Date: _____
State of: _____
County of: _____
Subscribed and sworn to before me this _____ day of _____

Notary Public:
My commission expires: _____

ARCHITECT'S CERTIFICATE FOR PAYMENT

In accordance with the Contract Documents, based on on-site observations and the data comprising this application, the Architect certifies to the Owner that to the best of the Architect's knowledge, information and belief the Work has progressed as indicated, the quality of the Work is in accordance with the Contract Documents, and the Contractor is entitled to payment of the AMOUNT CERTIFIED.

AMOUNT CERTIFIED \$ _____
(Attach explanation if amount certified differs from the amount applied. Initial all figures on this Application and on the Continuation Sheet that are changed to conform with the amount certified.)

ARCHITECT:
By: _____ Date: _____

This Certificate is not negotiable. The AMOUNT CERTIFIED is payable only to the Contractor named herein. Issuance, payment and acceptance of payment are without prejudice to any rights of the Owner or Contractor under this Contract.

CAUTION: You should sign an original AIA Contract Document, on which this text appears in RED. An original assures that changes will not be obscured.
 AIA Document G702™ – 1992, Copyright © 1963, 1963, 1965, 1971, 1978, 1983 and 1992 by The American Institute of Architects. All rights reserved. WARNING: This AIA® Document is protected by U.S. Copyright Law and International Treaties. Unauthorized reproduction or distribution of this AIA® Document, or any portion of it, may result in severe civil and criminal penalties, and will be prosecuted to the maximum extent possible under the law. Purchasers are permitted to reproduce ten (10) copies of this document when completed. To report copyright violations of AIA Contract Documents, e-mail The American Institute of Architects' legal counsel, copyright@aia.org.

Continuation Sheet

AIA Document G702™-1992, Application and Certificate for Payment, or G732™-2009, Application and Certificate for Payment, Construction Manager as Adviser Edition, containing Contractor's signed certification is attached. In tabulations below, amounts are in US dollars. Use Column I on Contracts where variable retainage for line items may apply.

APPLICATION NO:
APPLICATION DATE:
PERIOD TO:
ARCHITECT'S PROJECT NO:

A ITEM NO.	B DESCRIPTION OF WORK	C SCHEDULED VALUE	D WORK COMPLETED		F MATERIALS PRESENTLY STORED <i>(Not in D or E)</i>	G TOTAL COMPLETED AND STORED TO DATE <i>(D+E-F)</i>	H BALANCE TO FINISH <i>(C-G)</i>	I RETAINAGE <i>(if variable rate)</i>
			D FROM PREVIOUS APPLICATION <i>(D-E)</i>	E THIS PERIOD				
GRAND TOTAL								

CAUTION: You should sign an original AIA Contract Document, on which this text appears in RED. An original assures that changes will not be obscured.

AIA Document G703™ – 1992. Copyright © 1963, 1965, 1966, 1967, 1970, 1978, 1983 and 1992 by The American Institute of Architects. All rights reserved. **WARNING:** This AIA® Document is protected by U.S. Copyright Law and International Treaties. Unauthorized reproduction or distribution of this AIA® Document, or any portion of it, may result in severe civil and criminal penalties, and will be prosecuted to the maximum extent possible under the law. Purchasers are permitted to reproduce ten (10) copies of this document when completed. To report copyright violations of AIA Contract Documents, e-mail The American Institute of Architects' legal counsel, copyright@aia.org. 10-1204504

2. CONTRACTOR WAGE AFFIDAVIT

A. NOT USED.

B. NOT USED.

NOT FOR SUBMITTAL

SAMPLE ONLY .

NOT FOR

SUBMITTAL

SECTION 01 00 00
BASIC REQUIREMENTS

PART 1 GENERAL

1.1 SECTION SUMMARY

- A. Section Includes:
1. Section Summary
 2. Summary of the Work
 3. Contractor Use of Premises
 4. Applications for Payment
 5. Change Procedures
 6. Alternates
 7. Coordination
 8. Cutting and Patching
 9. Conferences
 10. Progress Meetings
 11. Submittal Procedures
 12. Proposed Products List
 13. Shop Drawings
 14. Product Data
 15. Samples
 16. Manufacturers' Instructions
 17. Manufacturers' Certificates
 18. Quality Assurance / Quality Control of Installation
 19. References
 20. Interior Enclosures
 21. Protection of Installed Work
 22. Parking
 23. Staging Areas
 24. Occupancy During Construction and Conduct of Work
 25. Protection
 26. Progress Cleaning
 27. Products
 28. Transportation, Handling, Storage and Protection
 29. Product Options
 30. Substitutions
 31. Starting Systems
 32. Demonstration and Instructions
 33. Contract Closeout Procedures
 34. Final Cleaning
 35. Adjusting
 36. Operation and Maintenance Data
 37. Spare Parts and Maintenance Materials
 38. As-Built and Record Drawings and Specifications

1.2 SUMMARY OF THE WORK

- A. Project Description: Perform the Work as specified and detailed in Construction Documents package. Contractor to provide . re-roofing of the Henry Vilas Zoo Herpetarium.
- B. Work by Owner: Not applicable.
- C. Permits: Prior to commencement of the Work, Contractor to secure any and all necessary permits for completion of the Work and facility occupancy.

1.3 CONTRACTOR USE OF PREMISES

- A. Limit use of premises to allow work by others and work by Owner.
- B. Limit use of premises to allow work by Contractors or Subcontractors and access by Owner.
- C. Coordinate utility outages and shutdowns with Owner.

1.4 APPLICATIONS FOR PAYMENT

- A. Submit one (1) original copies with “wet” signatures of each application on AIA G702™ and G703™ forms or approved contractors invoice form.
- B. Content and Format: Utilize Schedule of Values for listing items in Application for Payment.
- C. Payment Period: Monthly.
- D. Submit Applications for Payment to Public Works Project Manager for approval & processing for payment.

1.5 CHANGE PROCEDURES

- A. Change Order Forms: Dane County Contract Change Order, Form 014-32-20 (latest issue).
- B. Contractor's costs for Products, delivery, installation, labor, insurance, payroll, taxes, bonding, equipment rental, overhead and profit will be included in Change Orders authorizing expenditure of funds from contingency allowance.

1.6 ALTERNATES

- A. Alternates quoted on Bid Form shall be reviewed and accepted or rejected at Owner's option.
- B. Coordinate related work and modify surrounding work as required.

C. Schedule of Alternates: there are no alternates proposed for this project.

1.7 COORDINATION

- A. Coordinate scheduling, submittals, and work of various sections of Specifications to assure efficient and orderly sequence of installation of interdependent construction elements.
- B. Verify utility requirement characteristics of operating equipment are compatible with building utilities.
- C. Coordinate space requirements and installation of mechanical and electrical work that are indicated diagrammatically on Drawings.
- D. Refer to Drawings for recommended work sequence and duration.
- E. Contractor shall provide Public Works Project Engineer with work plan that ensures the Work will be completed within required time of completion.
- F. Public Works Project Manager may choose to photograph or videotape site or workers as the Work progresses.

1.8 CUTTING AND PATCHING

- A. Employ skilled and experienced installer to perform cutting and patching new work; restore work with new Products.
- B. Submit written request in advance of cutting or altering structural or building enclosure elements.
- C. Fit work tight to adjacent elements. Maintain integrity of wall, ceiling, or floor construction; completely seal voids.
- D. Refinish surfaces to match adjacent finishes.

1.9 CONFERENCES

- A. Project shall have pre-bid conference; see Instructions to Bidders.
- B. Owner will schedule preconstruction conference after Award of Contract for all affected parties.
- C. Contractor shall submit Construction Schedule at pre-construction meeting.
- D. When required in individual Specification section, convene pre-installation conference at project site prior to commencing work of Section.

1.10 PROGRESS MEETINGS

- A. Schedule and administer meetings throughout progress of the Work at minimum of one (1) per week with Public Works Project Manager.
- B. Preside at meetings, record minutes, and distribute copies within two (2) business days to those affected by decisions made.
- C. Attendance at progress meetings by General Contractor, subcontractors, or their authorized representative, is mandatory.
- D. Contractors shall give verbal reports of progress on the Work, discuss schedule for upcoming period and present all conflicts, discrepancies or other difficulties for resolution.
- E. Day & time of progress meetings to be determined at pre-construction meeting.

1.11 SUBMITTAL PROCEDURES

- A. Submittal form to identify Project, Contractor, Subcontractor or supplier; and pertinent Construction Documents references.
- B. Apply Contractor's stamp, signed or initialed, certifying that review, verification of Products required, field dimensions, adjacent construction work, and coordination of information is in accordance with requirements of the Work and Construction Documents.
- C. Identify variations from Construction Documents and Product or system limitations that may be detrimental to successful performance of completing the Work.
- D. Revise and resubmit submittals as required; identify all changes made since previous submittal.

1.12 PROPOSED PRODUCTS LIST

- A. Within fifteen (15) business days after date of Award of Contract, submit complete list of major Products proposed for use, with name of manufacturer, trade name, and model number of each Product.

1.13 SHOP DRAWINGS

- A. Submit number of copies that Contractor requires, plus three (3) copies that shall be retained by Public Works Project Manager.

1.14 PRODUCT DATA

- A. Submit number of copies that Contractor requires, plus two (2) copies that shall be retained by Public Works Project Manager.

- B. Mark each copy to identify applicable products, models, options, and other data. Supplement manufacturer's standard data to provide information unique to this Project.

1.15 SAMPLES

- A. Submit samples to illustrate functional and aesthetic characteristics of Product.
- B. Submit samples of finishes from full range of manufacturers' standard colors, textures, and patterns for Public Works Project Manager's selection.

1.16 MANUFACTURERS' INSTRUCTIONS

- A. When specified in individual Specification sections, submit manufacturers' printed instructions for delivery, storage, assembly, installation, start-up, adjusting, and finishing, in quantities specified for Product Data.

1.17 MANUFACTURERS' CERTIFICATES

- A. When specified in individual Specification sections, submit manufacturers' certificate to Public Works Project Manager for review, in quantities specified for Product Data.
- B. Indicate material or Product conforms to or exceeds specified requirements. Submit supporting reference data, affidavits, and certifications as appropriate.

1.18 QUALITY ASSURANCE / QUALITY CONTROL OF INSTALLATION

- A. Monitor quality control over suppliers, manufacturers, Products, services, site conditions, and workmanship, to produce work of specified quality.
- B. Comply fully with manufacturers' instructions.
- C. Comply with specified standards as minimum quality for the Work except when more stringent tolerances, codes, or specified requirements indicate higher standards or more precise workmanship.

1.19 REFERENCES

- A. Conform to reference standard by date of issue current as of date for receiving bids.
- B. Should specified reference standard conflict with Construction Documents, request clarification from Public Works Project Manager before proceeding.

1.20 INTERIOR ENCLOSURES

- A. Provide temporary partitions as required to separate work areas from Owner occupied areas, to prevent distribution of dust and moisture into Owner occupied areas, and to prevent damage to existing materials and equipment.

1.21 PROTECTION OF INSTALLED WORK

- A. Protect installed work and provide special protection where specified in individual Specification sections.

1.22 PARKING

- A. Arrange for temporary parking areas to accommodate construction personnel. Parking shall be available at the Work site.
- B. All contractors and their employees shall cooperate with General Contractor and others in parking of vehicles to avoid interference with normal operations and construction activities.
- C. Do not obstruct existing service drives and parking lots with equipment, materials and / or vehicles. Keep accessible for Owner's use at all times.

1.23 STAGING AREAS

- A. Coordinate staging areas with Public Works Project Manager prior to starting the Work.
- B. On-site space for use as staging areas and storage of materials is limited and will be apportioned among various Contractors as their needs dictate with due regard for storage requirements of each Contractor. Each Contractor shall be responsible for safety of equipment and materials that are stored on site.

1.24 OCCUPANCY DURING CONSTRUCTION AND CONDUCT OF WORK

- A. Smoking is prohibited on Dane County property.
- B. Owner reserves right at any time to dismiss from premises any Contractor or construction personnel that do not uphold requirements of this Section.
- C. Owner shall not be held liable for any lost time, wages, or impacts to construction schedule by any Contractor or construction personnel dismissed for failure to uphold requirements of this Section.
- D. Areas of existing facility will be occupied during period when the Work is in progress. Work may be done during normal business hours (8:00 am to 4:30 pm), but confer with Owner, schedule work and store materials so as to interfere as little as possible with normal use of premises. Work performed on Saturday shall be by permission of Owner. Notify Owner when coring or similar noise making work is to be done and obtain Owner's written approval of schedule. If schedule is not convenient for Owner, reschedule and resubmit new times for Owner approval. Coring of floor along with other noisy work may have to be done on second and third shifts.
- E. Work shall be done and temporary facilities furnished so as not to interfere with access to any occupied area and so as to cause least possible interference with normal operation of facility or any essential service thereof.

- F. Contractor shall, at all times, provide approved, safe walkways and facility entrances for use by Owner, employees and public.
- G. Contractor shall provide adequate protection for all parts of facility, its contents and occupants wherever the Work under this Contract is to be performed.
- H. Each Contractor shall arrange with Owner to make necessary alterations, do new work, make connections to all utilities, etc., at such times as will not cause interruption of utility services to facility. Contractor doing this work shall protect, cap, cut off and / or replace and relocate existing pipes, electrical work and other active utilities encountered which may interfere with new construction work.
- I. New work in extension of existing work shall correspond in all respects with that to which it connects or similar existing work unless otherwise indicated or specified.
 - 1. Existing work shall be cut, altered, removed or replaced as necessary for performance of Contract obligations.
 - 2. Work remaining in place, damaged or defaced by reason of work done under this Contract shall be restored equal to its condition at time of Award of Contract.
 - 3. If removal of work exposes discolored or unfinished surfaces or work out of alignment, such surfaces shall be refinished or materials replaced as necessary to make continuous work uniform and harmonious.
- J. Contractor is not responsible for providing & maintaining temporary toilet facilities.

1.25 PROTECTION

- A. Contractor shall protect from damage / injury all trees, shrubs, hedges, plantings, grass, mechanical, electrical & plumbing equipment, walks and driveways and pay for any damage to same resulting from insufficient or improper protection.
- B. Contractor shall provide and maintain barricades & signage to prohibit public access to construction site.

1.26 PROGRESS CLEANING

- A. Maintain areas free of waste materials, debris, and rubbish. Maintain site in clean and orderly condition.

1.27 PRODUCTS

- A. Products: Means new material, machinery, components, equipment, fixtures, and systems forming the Work, but does not include machinery and equipment used for preparation, fabrication, conveying and erection of the Work. Products may also include existing materials or components specifically identified for reuse.
- B. Do not use materials and equipment removed from existing premises, except as specifically identified or allowed by Construction Documents.

1.28 TRANSPORTATION, HANDLING, STORAGE AND PROTECTION

- A. Transport, handle, store and protect Products in accordance with manufacturer's instructions.

1.29 PRODUCT OPTIONS

- A. Where definite material is specified, it is not intentional to discriminate against "equal" product made by another manufacturer. Intention is to set definite standard of material quality. Should bidder choose to bid materials other than those specified, bidder shall submit said materials specifications to Public Works Project Manager for approval at least seven (7) business days prior to Bid Due Date.
- B. Products and materials that are not specified, but have been approved for use by Public Works Project Manager shall be identified in addenda to all bidding contractors.
- C. Requests for material or product substitutions submitted after Bid Due Date maybe considered. Owner reserves right to approve or reject substitutions based on Specification requirements and intended use.

1.30 SUBSTITUTIONS

- A. Public Works Project Manager shall consider requests for Substitutions only up to seven (7) business days prior to date of Bid Due Date.
- B. Document each request with complete data substantiating compliance of proposed Substitution with Construction Documents.
- C. Submit three (3) copies of requests for Substitution for consideration. Limit each request to one (1) proposed Substitution.
- D. Substitutions shall not change contract price established at Bid Due Date.

1.31 STARTING SYSTEMS

- A. Provide written notification prior to start-up of each equipment item or system.
- B. Ensure that each piece of equipment or system is ready for operation.
- C. Execute start-up under supervision of responsible persons in accordance with manufacturers' instructions.
- D. Submit written report that equipment or system has been properly installed and is functioning correctly.

1.32 DEMONSTRATION AND INSTRUCTIONS

- A. Demonstrate operation and maintenance of Products to Owner's personnel prior to date of final inspection.

- B. Demonstrate start-up, operation, control, adjustment, trouble-shooting, servicing, maintenance, and shutdown of each item of equipment at agreed-upon times, at designated location.
- C. Owner may choose to photograph or videotape demonstration session; demonstration and demonstrator shall be to level of satisfaction of Owner.

1.33 CONTRACT CLOSEOUT PROCEDURES

- A. Submit written certification that Construction Documents have been reviewed, the Work has been inspected, and the Work is complete in accordance with Construction Documents and ready for Public Works Project Manager's inspection.
- B. Submit final Application for Payment identifying total adjusted Contract Sum / Price, previous payments, and amount remaining due.

1.34 FINAL CLEANING

- A. Execute final cleaning prior to final inspection.
- B. Clean interior and exterior surfaces exposed to view.
- C. Remove waste and surplus materials, rubbish, and construction facilities from site.

1.35 ADJUSTING

- A. Adjust operating Products and equipment to ensure smooth and unhindered operation.

1.36 OPERATION AND MAINTENANCE MANUAL

- A. Provide two (2) bound, hard-copy operation and maintenance manuals that include all systems, materials, products, equipment, mechanical and electrical equipment and systems supplied and installed in the Work. Provide electronic version of operation and maintenance manual also.

1.37 SPARE PARTS AND MAINTENANCE MATERIALS

- A. Provide Products, spare parts, maintenance and extra materials in quantities specified in individual Specification Sections.
- B. Deliver to the Work site and place in location as directed.

1.38 AS-BUILT AND RECORD DRAWINGS AND SPECIFICATIONS

- A. Contractor-produced Drawings and Specifications shall remain property of Contractor whether Project for which they are made is executed or not. Contractor shall furnish Public Works Project Manager with original marked up redlines of Construction Documents' drawings and specifications that shall include all Addendums, Change Orders, Construction Bulletins, on-site changes, field corrections, etc. These are project

As-Built Drawings & Specifications.[Record Drawings & Specifications shall be created from these As-Builts by Public Works.]

- B. Architect / Engineer shall update original Construction Documents to include all Addendums & any other changes including those provided by Contractor in As-Built Drawings & Specifications. These updates are project Record Drawings & Specifications.
- C. Architect / Engineer shall furnish Public Works Project Manager with Record Drawings as detailed in Professional Services Agreement.

PART 2 PRODUCTS

Not Used.

PART 3 EXECUTION

Not Used.

END OF SECTION

SECTION 01 74 19

CONSTRUCTION WASTE MANAGEMENT, DISPOSAL & RECYCLING

PART 1 GENERAL

1.1 SUMMARY

- A. Section Includes:
 - 1. Summary
 - 2. Waste Management Goals
 - 3. Construction and / or Demolition Waste Management
 - 4. Waste Management Plan
 - 5. Reuse
 - 6. Recycling
 - 7. Materials Sorting and Storage On Site
 - 8. Lists of Recycling Facilities Processors and Haulers
 - 9. Waste Management Plan Form

- B. Related Sections:
 - 1. Section 01 00 00 - Basic Requirements

1.2 WASTE MANAGEMENT GOALS

- A. Dane County requires that as many waste materials as possible produced as result of this project be salvaged, reused or recycled in order to minimize impact of construction waste on landfills and to minimize expenditure of energy and cost in fabricating new materials. Additional information may be found in Dane County Green Building Policy, Resolution 299, 1999-2000.

1.3 CONSTRUCTION AND / OR DEMOLITION WASTE MANAGEMENT

- A. All construction and demolition waste suitable for recycling may go to Dane County Construction & Demolition Recycling Facility located at 7102 US Hwy 12, Madison, located across from Yahara Hills Golf Course. This facility can receive mixed loads of construction and demolition waste. For complete list of acceptable materials see www.countyofdane.com/pwht/recycle/CD_Recycle.aspx.
- B. Dane County Landfill, also at 7102 US Hwy 12, Madison, must receive all other waste from this project. www.countyofdane.com/pwht/recycle/landfill.aspx.

1.4 WASTE MANAGEMENT PLAN

- A. Contractor shall develop Waste Management Plan (WMP) for this project. Dane County's Special Projects & Materials Manager may be contacted with questions. Outlined in RECYCLING section of this specification are examples of materials that can be recycled or reused as well as recommendations for waste sorting methods.

B. Contractor shall complete WMP and include cost of recycling / reuse in Bid. WMP will be submitted to Public Works Project Manager within fifteen (15) business days of Bid Due date. Copy of blank WMP form is in this Section. Submittal shall include cover letter and WMP form with:

1. Information on:
 - a. Types of waste materials produced as result of work performed on site;
 - b. Estimated quantities of waste produced;
 - c. Identification of materials with potential to be recycled or reused;
 - d. How materials will be recycled or reused;
 - e. On-site storage and separation requirements (on site containers);
 - f. Transportation methods; and
 - g. Destinations.

1.5 REUSE

A. Contractors and subcontractors are encouraged to reuse as many waste materials as possible. Salvage should be investigated for materials not reusable on site.

1.6 RECYCLING

A. These materials may be recycled at Dane County Construction & Demolition Recycling Facility:

1. Wood.
2. Wood Pallets.
3. PVC Plastic (pipe, siding, etc.).
4. Asphalt & Concrete.
5. Bricks & Masonry.
6. Vinyl Siding.
7. Cardboard.
8. Metal.
9. Unpainted Gypsum Drywall.
10. Shingles.

B. These materials can be recycled elsewhere in Dane County area:

1. Fluorescent Lamps.
2. Foam Insulation & Packaging (extruded and expanded).
3. Carpet Padding.
4. Barrels & Drums.

C. All materials must be recycled at WDNR permitted waste processing facilities that adhere to all State Statutes.

1.7 MATERIALS SORTING AND STORAGE ON SITE

A. Contractor shall provide separate containers for recyclable materials. Number of containers will be dependent upon project and site conditions.

B. Contractor shall provide on-site locations for subcontractors supplied recycling containers to help facilitate recycling.

- C. Mixed loads of recycled materials are allowed only per instructions at www.countyofdane.com/pwht/recycle/CD_Recycle.aspx.

1.8 LISTS OF RECYCLING FACILITIES PROCESSORS AND HAULERS

- A. Refer to www.countyofdane.com/pwht/recycle/CD_Recycle.aspx for information on Dane County Construction & Demolition Recycling Facility.
- B. Web site www.countyofdane.com/pwht/recycle/categories.aspx lists current information for Dane County Recycling Markets. Contractors can also contact Allison Hackner at 608/266-4990, or local city, village, town recycling staff listed at site www.countyofdane.com/pwht/recycle/contacts.aspx. Statewide listings of recycling / reuse markets are available from UW Extension at <https://www.uwgb.edu/shwec/>.

PART 2 PRODUCTS

Not Used.

PART 3 EXECUTION

Not Used.

END OF SECTION

WASTE MANAGEMENT PLAN FORM



Contractor Name: _____

Address: _____

Phone No.: _____ Recycling Coordinator: _____

MATERIAL	ESTIMATED QUANTITY	DISPOSAL METHOD (CHECK ONE)		RECYCLING / REUSE COMPANY OR DISPOSAL SITE
Salvaged & reused building materials	_____ cu. yds. _____ tons	_____ Recycled _____ Landfilled	_____ Reused _____ Other	Name: _____
Wood	_____ cu. yds. _____ tons	_____ Recycled _____ Landfilled	_____ Reused _____ Other	Name: _____
Wood Pallets	_____ units	_____ Recycled _____ Landfilled	_____ Reused _____ Other	Name: _____
PVC Plastic	_____ cu. ft. _____ lbs.	_____ Recycled _____ Landfilled	_____ Reused _____ Other	Name: _____
Bricks & Masonry	_____ cu. ft. _____ lbs.	_____ Recycled _____ Landfilled	_____ Reused _____ Other	Name: _____
Cardboard	_____ cu. ft. _____ lbs.	_____ Recycled _____ Landfilled	_____ Reused _____ Other	Name: _____
Metals	_____ cu. yds. _____ tons	_____ Recycled _____ Landfilled	_____ Reused _____ Other	Name: _____
Unpainted Gypsum / Drywall	_____ cu. yds. _____ tons	_____ Recycled _____ Landfilled	_____ Reused _____ Other	Name: _____
Shingles	_____ cu. yds. _____ tons	_____ Recycled _____ Landfilled	_____ Reused _____ Other	Name: _____
Fluorescent Lamps	_____ cu. ft. _____ lbs.	_____ Recycled _____ Landfilled	_____ Reused _____ Other	Name: _____
Foam Insulation	_____ cu. ft. _____ lbs.	_____ Recycled _____ Landfilled	_____ Reused _____ Other	Name: _____
Carpet Padding	_____ cu. ft. _____ lbs.	_____ Recycled _____ Landfilled	_____ Reused _____ Other	Name: _____
Glass	_____ cu. yds. _____ tons	_____ Recycled _____ Landfilled	_____ Reused _____ Other	Name: _____
Other	_____	_____ Recycled _____ Landfilled	_____ Reused _____ Other	Name: _____
Other	_____	_____ Recycled _____ Landfilled	_____ Reused _____ Other	Name: _____

SECTION 00600

SAMPLE STORAGE AGREEMENT

**SPECIAL PROCEDURE FOR OBTAINING PAYMENT FOR MATERIALS
NOT STORED AT THE SITE OF THE WORK**

This Agreement applies only to:

Project:

Project No.:

Due to the limited amount of space available for the storage of materials at the site, the Owner, under the following conditions, approves partial payments for certain materials stored off the premises.

1. **Prior Approval:** The Contractor shall obtain the approval of the Owner before making any arrangements to obtain a Certificate for Payment for materials stored off the site. Materials must be suitable for storage and must be properly packaged if this is necessary.
2. **Storage Site:** The Contractor shall furnish and maintain a suitable storage site and proper storage conditions which must be approved in advance by the Engineer assigned to the Project. The site must be within the State of Wisconsin.
3. **Storage Conditions:** The material covered by the request for certification for partial payment must be stored above grade and must be properly protected at all times against weather, heat, cold, moisture, and other hazards as the material may require. The Engineer must approve the storage conditions. All protection must be provided by the Contractor at his own expense and must be maintained throughout the storage period.

Material must not be co-mingled with other similar material, but must be stored by itself and must be plainly labeled **“Property of Dane County Public Works”**.

It must be stored so that it can be readily inspected, measured, and counted at all times by the Engineer.

4. **Bill of Sale:** Request for certification for partial payment for materials stored under the above conditions must be accompanied by a Bill of Sale, properly identifying the material and transferring ownership of the materials to the Owner. The Bill of Sale must be accompanied by an inventory of the stored material together with a description of the storage site by street number and city, or by legal description of the premises.
5. **Insurance:** The Owner shall be notified to cause the builders risk, fire, and extended coverage insurance policy covering this Project to include the materials, stored off site, in the amount and under the same conditions as that provided for material stored on site of the Project. The signing of “Storage Conditions Approved” shall be confirmation that insurance coverage has been provided. Unless specifically exempted by the Owner, the Contractor shall furnish insurance against loss by theft or vandalism, and the Owner shall be named the beneficiary under the policy, as trustee for all concerned. A Certificate of Insurance must be provided the Engineer prior to his approval of this Agreement.

6. **Responsibility:** The Contractor agrees that in accepting partial payments for the stored materials he is in no way relieved of responsibility for the safe storage of the material and its safe transportation and installation in the Work, or for furnishing and installing the material in strict accordance with the Drawings and Specifications.

The Contractor also agrees that acceptance by the Owner of a Bill of Sale for the material does not imply acceptance of the material, which shall be subject to final acceptance or rejection up to the time the Contractor's work is completed and finally accepted.

The Contractor also agrees that the usual guarantee covering his work under the Drawings, Specifications and Contract, are in no way impaired as a result of the partial payment and the acceptance of the Bill of Sale.

The Owner accepts no responsibility in connection with the material.

7. **Acceptance:** The Contractor shall indicate his acceptance of the above conditions by signing and returning one copy of this Storage Agreement.

ACCEPTED:

Signature

Date

Contractor

STORAGE CONDITIONS APPROVED:

SRI Consultants, Inc.

Date

Engineer

Material Stored: _____

Storage Site: _____

- END OF SECTION -

SECTION 00700

GENERAL AND SUPPLEMENTARY CONDITIONS

The “General Conditions of the Contract for Construction” as prepared by Dane County, hereinafter referred to as the “General Conditions” are hereby made part of the Contract Documents.

The General Conditions may be examined at the offices of the Owner and/or Engineer.

SUPPLEMENTARY CONDITIONS

These Supplementary Conditions amend or supplement the “General Conditions of the Contract for Construction” as prepared by Dane County. Where any article of the General Conditions is amended, or any paragraph, subparagraph, or clause thereof is amended or deleted by these Supplementary Conditions, the unamended and undeleted provisions of that article, paragraph, subparagraph or clause shall remain in full force and effect.

ARTICLE 2 - DEFENITIONS

Add the following Basic Definitions:

8. PROVIDE

As used in connection with labor, materials, and equipment shall mean to furnish and install complete, including connections to utilities or service, complete anchorage and suspension, fastening or anchor devices, trim, finish and other related work, unless specifically specified otherwise.

9. APPROVED, SATISFACTORY, EQUAL TO, PROPER,,AS DIRECTED AND SIMILAR TERMS

These shall mean the decision rests with the Engineer, whose decision shall be final and binding upon the Contractor and Subcontractor.

10. NOTICE TO PROCEED

This shall mean verbal or written notice by the Engineer or Owner to the Contractor to commence Work of the Contract, issued either before or after execution of the Contract. If verbally given, and the Contractor requests, the Notice shall be confirmed in writing. In issuing the Notice, stipulations may be included as to time and other requirements that may condition commencement of the Work.

ARTICLE 12 – SURVEYS, PERMITS, REGULATIONS AND TAXES

Add the following Paragraphs:

H. Terminology used in this Subsection shall be as defined in Federal Register 40 CFR Part 763, Subpart E - Asbestos-Containing Materials.

I. Use of asbestos-containing materials as part of the Work is expressly prohibited. The Contractor shall notify the Engineer, in writing, as to conflicts with this subparagraph and the Specifications so that substitute materials can be investigated and a directive can be issued per Article 7 of the General Conditions. In case of conflict, this subparagraph shall govern.

J. The Contractor shall submit Material Safety Data Sheets (MSDS) per Paragraph 3.19 for all suspect products utilized as part of the Work.

ARTICLE 21 - CORRECTION OF WORK

Add the following paragraph:

C. Neither the final payment nor any provision in the Contract Documents shall relieve the Contractor of the responsibility for negligence or faulty materials or workmanship within the extent and period provided by the Law.

ARTICLE 42 - PROTECTION OF LIVES AND HEALTH

10.1 - SAFETY PRECAUTIONS AND PROGRAMS

Add the following:

C. Terminology used in this Subsection shall be as defined in Federal Register 40 CFR Part 763, Subpart E - Asbestos-Containing Materials.

D. Contractor shall contact the Owner and Engineer if asbestos containing building materials (ACBM) or suspected ACBM are uncovered or encountered during the performance of the Work. (Note: This does not pertain to asbestos-containing roofing materials [ACRM] which shall be the responsibility of the Contractor to conform to DHSS 159 regulations.) The Contractor shall not disturb ACBM or suspect ACBM and Work in the area shall be suspended, if necessary to prevent release of asbestos fibers. The Owner shall authorize the Work to proceed following removal of ACBM or bulk sampling to confirm suspected ACBM does not contain asbestos.

E. Asbestos management plans are available in the Administrative Office at each building and at Building Services that identifies the locations of asbestos-containing materials. The Contractor, his Subcontractors, and agents shall not disturb friable ACBM nor make non-friable ACBM friable in the course of the Work unless specified herein. Unless it is otherwise expressly provided in the Contract Documents:

.1 The Owner shall arrange and pay for all costs associated with the bulk sampling of ACBM and suspect ACBM.

.2 The Owner shall arrange and pay for all costs associated with removal of ACBM and air monitoring.

.3 The Contractor shall be required to review the site with the Owner prior to start of Work for ACBM or suspect ACBM as it relates to the Work.

.4 The Contractor shall indemnify and hold harmless the Owner and its Consultants against claims, damages, losses and expenses resulting from the willful or negligent damage of asbestos-containing material during the performance of the Work.

--- END OF SECTION ---

SECTION 01090

REFERENCES

PART 1 -- GENERAL

1.01 References

- A. The standards and Manufacturers' association requirements issued by the following agencies are considered a part of these Specifications. Should conflict occur between Project Specifications and references, Project Specifications shall govern. Referenced material and modifications to each are indicated in each section they apply to. The following is a list of these organizations:

AA	Aluminum Association 818 Connecticut Avenue, NW Washington, DC 10006 (202) 862-5100
AAMA	Architectural Aluminum Manufacturers Association 35 E. Wacker Drive Chicago, IL 60601 (312) 782-8256
ACI	American Concrete Institute Box 19150 Redford Station Detroit, MI 48219 (313) 532-2600
ACIL	American Council of Independent Laboratories 1725 K Street NW Washington, D.C. 20006 (202) 659-3766
AIA	American Institute of Architects 1735 New York Avenue, NW Washington, D.C. 20006 (202) 626-7474
AITC	American Institute of Timber Construction 33 W. Hampden Avenue Englewood, CO 80110 (303) 761-3212
ANSI	American National Standards Institute 1430 Broadway New York, NY 10018 (212) 354-3300

ASHRAE American Society of Heating, Refrigeration and Air
Conditioning Engineers
1791 Tullie Circle NE
Atlanta, GA 30329
(404) 636-7722

ASME American Society of Mechanical Engineers
345 East 47th Street
New York, NY 10017
(212) 644-7722

ASPE American Society of Plumbing Engineers
15233 Ventura Boulevard
Sherman Oaks, CA 91403
(213) 783-4845

ASTM American Society for Testing and Materials
100 Bar Harbor Drive
West Conshohocken, PA 19428-2959
(610) 832-9555

AWI Architectural Woodwork Institute
2310 S. Walter Reed Drive
Arlington, VA 22206
(703) 671-9100

AWS American Welding Society
550 LeJune Road
Miami, FL 33135
(305) 642-7090

BHMA Builders' Hardware Manufacturers Association
(c/o TGAM)
60 East 42nd Street, Room 1807
New York, NY 10017
(212) 682-8142

FM Factory Mutual Engineering Corporation
1151 Boston-Providence Turnpike
Norwood, MA 02062
(617) 762-4300

FS	Federal Specification (General Services Admin.) Building 179 Washington Navy Yard, SE Washington, D.C. 10407
MCAA	Mechanical Contractors Association of America 5530 Wisconsin Avenue Washington, D.C. 20015 (202) 654-7960
MIL	Military Standardization Documents (U.S. Dept. of Defense) Naval Publications and Forms Center 5801 Tabor Avenue Philadelphia, PA 19120
MRCA	Midwest Roofing Contractors Association 4840 West 15th Street, Suite 1000 Lawrence, KS 66049 (913) 843-4888
NAAMM	The National Association of Architectural Metal Manufacturers 21 N. LaSalle Street Chicago, IL 60601 (312) 346-1600
NCMA	National Concrete Masonry Association P. O. Box 781 Herndon, VA 22070 (703) 435-4900
NECA	National Electrical Contractors Association 7315 Wisconsin Avenue Washington, D.C. 20014 (301) 657-3110
NEMA	National Electrical Manufacturers Association 2102 L Street NW Washington, D.C. 20037
NFPA	National Fire Protection Association 470 Atlantic Avenue Boston, MA 02210 (617) 482-8755

NRCA National Roofing Contractors Association
O'Hare International Center
10255 West Higgins Road, Suite 600
Rosemont, IL 60018-5607
(708)-299-9070

OSHA Occupational Safety and Health Administration
(U.S. Department of Labor)
Government Printing Office
Washington, D.C. 20402

PDI Plumbing and Drainage Institute
5342 Boulevard Pl.
Indianapolis, IN 46208
(317) 251-5298

SDI Steel Deck Institute
P. O. Box 3812
St. Louis, MO 63122
(314) 965-1741

SJI Steel Joist Institute
1703 Parham Road
Richmond, VA 23229
(804) 288-3071

SMACNA Sheet Metal and Air Conditioning Contractors' National Association
8224 Old Courthouse Road
Vienna, VA 22180
(703) 790-9890

TIMA Thermal Insulation Manufacturers Association
7 Kirby Plaza
Mt. Kisco, NY 10549
(914) 241-2284

UL Underwriters Laboratories
333 Pfingsten Road
Northbrook, IL 60062
(312) 272-8800

-- END OF SECTION ---

SECTION 01091

DEFINITIONS

PART 1 -- GENERAL

1.01 DEFINITIONS

- A. "Provide" -- Supply materials, products and services as well as furnish labor for installation and completion of items of work mentioned.
- B. "Furnish" -- Design, fabricate, purchase and deliver to the job site or other destination (all at Contractor's expense) as directed by Specification, Owner or Engineer.
- C. "Or Approved Equal" clause -- Where use of "or approved equal" clause appears in reference to a given product, material or item of work, no other product, system, material or item of work will be considered for use in the Work or used as a basis for bidding except when submitted and approved in writing by Engineer as required.
- D. "Or Equal" clause -- Where use of "or equal" clause appears in reference to a given product, materials or items or work, no other products, system, material or item of work shall be used that is not equal in performance, quality, construction and finish to product system, material or item of work specified.
- E. "Debris" -- Rubbish, garbage, empty containers and wrapping and materials that cannot be used in the Work and not to be retained by the Owner.
- F. "Owner" -- Dane County.
- G. "Work" -- Consisting of all labor and operations, transportation, hoisting, materials, tools, equipment, services, inspections, investigations, coordination and supervision required and/or reasonably necessary to produce the construction required by the Contract Documents.
- H. Where "as directed", "as required", "ordered", "prescribed", "approved", "acceptance" or words of similar nature are used, it shall be understood that such words refer to actions to be taken, in writing, by the Contractor unless otherwise stated. The words, "necessary", "suitable", "equal" or words of like import shall mean necessary or equal in the opinion of the Owner and Engineer.
- I. "Install or Installation" -- The act of physically placing, applying, setting, erecting, anchoring, securing, etc. construction materials, equipment, furnishings, appliances and similar items specified and furnished at the job site. Installation of specified items shall be complete in all respects and at the Contractor's expense.
- J. "Asbestos" -- The asbestiform varieties of chrysotile (serpentine); crocidolite (riebeckite); amosite (cummington itegrunerite); anthophyllite; tremolite; and actinolite.
- K. "Asbestos-Containing Material (ACM)" -- When referring to buildings means any material or product which contains more than one percent asbestos.

- L. "Asbestos-Containing Building Material (ACBM)" -- Surfacing asbestos-containing materials (ACM), thermal system insulation ACM, or miscellaneous ACM that is found in or on interior structural members or other parts of a building.
- M. "Asbestos-Containing Roofing Material (ACRM)" -- Roof material composed of asbestos of any type and in an amount greater than 1% by weight, either alone or mixed with other fibrous or nonfibrous materials.

The Contractor is advised to consult the "Glossary" included in the most recent edition of "NRCA Roofing and Waterproofing Manual".

--- END OF SECTION ---

SECTION 01300

SUBMITTALS

PART 1 – GENERAL

1.01 PROCEDURES

- A. Deliver submittals to Engineer at the office of SRI Consultants, Inc. (SRI), 3207 Laura Lane, Middleton, Wisconsin 53562 or by e-mail to tculli@sri-msn.com
- B. Identify submittals with Contractor's name, Project name and date of submittal.
- C. Make any corrections to the submittals required by Engineer and resubmit until approved. Direct specific attention in writing to revisions on resubmittals other than the corrections requested by the Engineer.

1.02 SUBMITTAL SCHEDULE

- A. Schedule and make all submittals in an orderly sequence so as to cause no delay in the Work or in the work of other Contractors.
- B. Ensure submittals are made far enough in advance of the related Work activity to provide time required for reviews, revisions, resubmittals, approvals, placing orders and securing materials and equipment.
- C. If hard copies are sent, a total of three (3) copies of each submittal are required.
- D. In scheduling, allow at least ten (10) days for review following receipt of a submittal by the Engineer. Allow five (5) days for review of a resubmittal.

1.03 CONSTRUCTION SCHEDULE

- A. Submit work schedule in graph or tabular form for the various phases of the Work including delivery of materials to site, set-up, start-up, tear off (if applicable), recover, phased work (with area designation and key plan), detail reconstructions (if applicable), metal work, etc.
- B. Should any activity critical to the full completion date be, in the judgment of the Engineer, behind schedule by seven (7) or more days, the Engineer may direct the Contractor to expedite the Work to regain compliance with the schedule. If so directed, the Contractor shall promptly expedite the Work by whatever means required including but not limited to, increasing the work force, adding additional shifts and working overtime. Such expediting shall be at no additional cost to the Owner. Failure of the Engineer to so direct shall not relieve the Contractor of his responsibility to comply with the construction schedule.
- C. Submit documents to claim conflicts with the work schedule due to weather, labor, etc. within ten (10) working days of said incident(s) for proper evaluation and action by the Engineer.

1.04 SHOP DRAWINGS AND SAMPLES

- A. Submit all drawings, diagrams, illustrations, schedules, performance charts, instructions, specifications and other product data illustrating portions of the Work as required by the Specification sections. Such submittals, whether or not referred to as shop drawings, shall comply with the requirements for shop drawings herein prescribed. Unless otherwise noted in the Specification sections, submit a minimum of three (3) sets of shop drawings to the Engineer.
- B. Submit all samples of materials, equipment and workmanship as required by the Specification sections.
- C. Unless the precise color and pattern is specifically specified in the Specification sections, and whenever a color or pattern is available in a specified product, submit accurate color and pattern charts and samples for review and selection.
- D. Review, stamp with approval and submit all shop drawings and samples required by the Specification sections. Shop drawings or samples submitted without the Contractor's approval stamp will be returned without review.
- E. By approving and submitting shop drawings and samples, the Contractor thereby represents that he has determined and verified all field measurements, field construction criteria, materials, catalog numbers and similar data and that he has checked and coordinated each shop drawing and sample with the requirements of the Work and of the Contract Documents.
- F. Shop drawings and samples will be reviewed and approved by the Owner and/or Engineer to determine in general if they are in compliance with the Contract Documents. Such approval shall not relieve the Contractor of responsibility for any deviations from the requirements of the Contract Documents or from the responsibility for errors or omissions in the shop drawings or samples.
- G. Do not commence any portion of the Work requiring a shop drawings or sample submittal until the submittal has been approved as prescribed herein. All such portions of the Work shall be in accordance with approved shop drawings or samples.

1.05 MATERIAL SAFETY DATA SHEETS

- A. Submit "Material Safety Data Sheets" per Supplementary Conditions, Section 3.19.1.

1.06 CERTIFICATES OF COMPLIANCE

- A. Submit in duplicate, certificates of compliance for each product specified, prior to installation of applicable product.
- B. Certificates of compliance shall include certified laboratory test reports, manufacturer's certificates or other evidence sufficient to verify compliance with the products specified.
- C. Submit all warranties, guarantees, manuals, etc. as described more fully in subsequent sections.

1.07 WAIVER OF LIEN

- A. Submit for approval, duplicate sample of executed Waiver of Lien to be used with each invoice.
- B. Submit letter listing persons approved to sign Waiver of Lien.

--- END OF SECTION ---

SECTION 01400

QUALITY REQUIREMENTS

PART 1 -- GENERAL

1.01 QUALITY OF WORK

- A. Perform all Work in the most workmanlike manner and according to the best standard practices. All Work shall be free from faults and defects in workmanship.
- B. Contractor shall be solely responsible for quality control of the Work and shall maintain quality control over suppliers, manufacturers, products, services, site conditions, and workmanship, to produce work of specified quality.
- C. Required testing and inspection are intended to assist in determination of probable compliances of the Work with the Contract Documents, but do not relieve the Contractor of responsibility for those compliances. Specified testing and inspection are not intended to limit the Contractor's quality control program.

1.02 TESTING AND INSPECTION

- A. Testing and inspection, where required by the Specification sections, shall comply with the specific requirements of the applicable Specification section and general requirements contained herein.
- B. All testing and inspection whether required by the Specification sections or by laws, ordinances, rules, regulations, codes or orders of any public authority having jurisdiction or whether performed by the Contractor for quality control shall be at the Contractor's expense unless otherwise indicated in the Contract Documents.
- C. Fully cooperate and coordinate with the personnel of any testing agency whether performing testing or inspection required by the Contract Documents or any public authority having jurisdiction or performing special testing and inspection required by the Engineer and regardless of whether the testing and inspection has been arranged for by the Contractor, Engineer or a public authority having jurisdiction. Testing agency personnel shall have access to the Work at all time for the performance of such testing and inspection and the Contractor shall provide facilities for access in order that the testing agency may properly perform its function.

1.03 TESTING LABORATORY SERVICES

- A. Where the Specification sections require testing or inspection by a testing laboratory, engage a reputable, independent testing laboratory specializing in the required services unless the testing or inspection is indicated as furnished by the Owner. Testing laboratory shall be approved by the Engineer.
- B. Specimens and samples for testing or inspection shall be taken by the testing laboratory.
- C. Submit written reports of results of such testing or inspection, in duplicate, to the Engineer within three (3) days after completion of the testing or inspection. Reports shall clearly indicate compliance or non-compliance with specified standards and with the Contract Documents.

- D. Secure required certificates of testing, inspection or approval and promptly deliver to the Engineer.
- E. Give the Engineer timely notice of the Work ready to be tested or inspected.
 - 1. Unless the testing or inspection is indicated as furnished by the Owner, give the Engineer timely notice of the date and time arranged so the Engineer may observe the testing or inspection.
 - 2. If the testing or inspection is indicated as furnished by the Owner, the Engineer will arrange for a testing laboratory to perform the required services.
- F. If testing or inspection is indicated as furnished by the Owner, the Owner will engage an independent testing laboratory to perform the required services at the Owner's expense. Any testing or inspection furnished by the Owner shall not constitute acceptance of the Work tested or inspected and shall not relieve the Contractor of his responsibility to comply with the Contract Documents. Written reports of results of testing or inspections furnished by the Owner will be made available to the Contractor upon written request.

1.04 SPECIAL TESTING AND INSPECTION

- A. In addition to testing and inspection required by the Contract Documents, the Engineer may require special testing and inspection as provided in the General Conditions. The Engineer may instruct the Contractor to arrange for such special testing and inspection or may arrange for the special testing and inspection directly. If the Work so tested or inspected is found to be in compliance with the Contract Documents, the cost of testing or inspection shall be charged to the Owner by appropriate Change Order. If the Work is found not to be in compliance, the Contractor shall pay such costs.

--- END OF SECTION ---

SECTION 01630

SUBSTITUTIONS AND PRODUCT OPTIONS

PART 1 – GENERAL

1.01 PRODUCT LIST

- A. Within seven (7) calendar days after award of Contract, submit to Engineer three (3) hard copies, or one copy by e-mail, of complete list of major products which are proposed for installation.
- B. Tabulate products by Specification section number and title.
- C. For products specified only by reference standards, list for each sub products:
 - 1. Name and address of Manufacturer.
 - 2. Trade name.
 - 3. Model or catalog designation.
 - 4. Manufacturer's data:
 - a. Referenced standards
 - b. Performance test data.

1.02 CONTRACTOR'S OPTION

- A. For products specified only by reference standards, select products meeting those standards by any manufacturer.
- B. For products specified by naming several products or manufacturers, select any one of the products and manufacturers named which complies with the product specifications.
- C. For products specified by naming one or more products or manufacturers and stating "or equal", submit a request as for substitutions, for any product or manufacturer which is not specifically named.
- D. For products specified by naming only one product and manufacturer, there is no option and no substitution allowed.

1.03 SUBSTITUTIONS

- A. Within a period of seven (7) calendar days after award of Contract, the Engineer will consider formal requests from the Contractor for substitution of products in place of those specified.
 - 1. After the end of that period, requests will be considered only in the case of product unavailability or other conditions beyond the control of the Contractor.
- B. Submit separate request for each substitution. Support each request with:
 - 1. Complete data substantiating compliance of proposed substitution with requirements stated in Specifications.

- a. Product identification including manufacturer's name and address.
 - b. Manufacturer's literature - identify:
 - 1. Product description.
 - 2. Reference standards.
 - 3. Performance test data.
 - c. Samples where applicable.
 - d. Name and address of similar projects on which the product has been used and date of each installation.
- 2. Itemized comparison of the proposed substitutions with product specified. List all significant variations.
 - 3. Data relating to changes in the construction schedule.
 - 4. List of changes required in other work or products.
 - 5. Accurate cost data comparing proposed substitution with products specified.
 - 6. Designation of required license fees or royalties if applicable.
 - 7. Designation of availability of maintenance services and sources or replacement materials.
- C. Substitutions will not be considered for acceptance when:
- 1. They are indicated or implied on shop drawings or product data submittals without a formal request from the Contractor.
 - 2. They are requested directly by Subcontractor or Supplier.
 - 3. Acceptance will require substantial revision to the Contract Documents.
- D. Substitute products shall not be ordered or installed without written acceptance from the Owner or Engineer.
- E. The Engineer will determine acceptability of proposed substitutions.

1.04 APPROVED EQUAL PRODUCT OPTION

- A. Within a period of three (3) calendar days prior to the Bid Due Date, the Engineer will consider formal requests from the Contractor for "approved equal" substitutions.
- B. Each request for Engineer approval consideration shall be prepared and submitted as set forth in Subsection 1.03 -- Substitutions.

1.05 CONTRACTOR'S REPRESENTATION

- A. In making form requests for substitution or approved equals, the Contractor represents that:
1. He has investigated the proposed product and he has determined that it is equal to or superior in all respects to that specified.
 2. He will provide same warranties or bonds for substitution as for product specified.
 3. He will coordinate installation of accepted substitution into the Work and will make such changes as may be required for the Work to be complete in all respects.
 4. He waives all claims for additional costs caused by the substitution which may subsequently become apparent.
 5. Cost data is complete and includes related costs under his Contract but not:
 - a. Costs under separate Contracts.
 - b. Engineer's costs for redesign or revision of Contract Documents.

1.06 ENGINEER'S DUTIES

- A. Review Contractor's requests for substitutions with reasonable promptness. Notify the Contractor in writing of decision to accept or reject requested substitutions.

--- END OF SECTION ---

SECTION 02070

DEMOLITION

PART 1 -- GENERAL

1.01 CONDITIONS OF THE CONTRACT

- A. The conditions of the Contract (General, Supplementary, and Other Conditions) and the requirements of Division 1, are hereby made a part of this Section. Applicable provisions of Division 1 shall govern Work under this Section.

1.02 WORK INCLUDED

- A. Provide all labor, materials, services and incidentals necessary to perform the following work:
 - 1. Remove and dispose of existing shingles and underlayment on the entire roof. Remove the plywood decking and existing fiberglass insulation on the Herpetarium side as shown on the Drawings.
 - 2. Remove and dispose of existing metal work associated with the roof system.
 - 3. Remove and dispose of all contingent materials as required and specified. If Asbestos containing materials are encountered, Dane County Public works will properly remove and dispose of the material.
 - 4. Remove all existing power vents and ridge vent.

1.03 RELATED SECTIONS

- A. Section 06010 – General Carpentry.
- B. Section 07201 - Insulation.
- C. Section 07310 – Asphalt Shingles
- D. Section 07620 - Sheet Metal Flashing and Trim.
- E. Section 07900 - Sealants.

1.04 REGULATORY REQUIREMENTS

- A. The following regulatory agencies' requirements shall be enforced:
 - 1. Occupational Safety and Health Administration (OSHA).
 - 2. Wisconsin Administrative Code.
 - 3. United States Department of Transportation (US DOT).

4. Environmental Protection Agency (EPA).
5. National Emission Standards for Hazardous Air Pollutants (NESHAP).
6. In Wisconsin:
 - a. Department of Natural Resources (DNR).
 - b. Department of Health and Social Services (DHSS).
- B. The Contractor shall perform all Work in accordance with State of Wisconsin Department of Health and Social Services, HSS 159.
- C. The Engineer on this Project is not an advisor of asbestos-related issues. The Contractor shall consult the Owner's Asbestos Consultant for clarifications.

1.05 PROTECTION

- A. When Work involves removal of roofing materials, the following **minimum** requirements shall be enforced:
 1. The Contractor shall exercise extreme caution and take all necessary precautions to limit exposing his workmen or bystanders to any dangerous conditions.
 2. Protect all existing utilities against damage. Maintain existing utilities during demolition operations.
 3. Protect passageways and maintain all exit ways to ensure the safe passage of persons around the area of demolition.
 4. Conduct operations in a manner that will prevent damage by falling debris, or other causes.
 5. Provide interior and exterior shoring, bracing, or support required to prevent movement, settlement, or collapse of adjacent facilities indicated to remain.
 6. Protect all remaining portions of the building and property not scheduled for demolition. These areas shall be completely protected during demolition and removal of debris. Any resulting damage shall be repaired or replaced to like-new condition by the Contractor responsible under the direction and approval of the Owner or Engineer.
 7. Protect all landscaping from damage and replace or repair any landscaping to like-new condition by the Contractor responsible. Grass areas damaged shall be replaced with sod and sufficiently watered for two weeks by the Contractor.
 8. Cover air vents designated by the Owner with filter fabric or plastic sheet to prevent visible dust and debris from entering the building. Remove filter fabric or plastic sheet upon job completion.
 9. When the Work involves removal of roofing materials containing asbestos, notify the Owner's

Asbestos Consultant immediately for proper removal procedural information.

1.06 OCCUPANCY

- A. The Owner shall occupy the building during demolition and construction and the facility shall remain operational.
- B. Coordinate all Work in advance with the Owner.

1.07 DUST CONTROL

- A. The following **minimum** requirements will be enforced:
 - 1. It is imperative that dust be kept to a minimum during removal of the roofing system.
 - 2. Debris shall be transported on covered trucks.
 - 3. Debris shall be removed as it accumulates.
 - 4. As it pertains to interior conditions, no excessive disturbance of the structure which causes air-borne debris will be tolerated.

PART 2 -- EXECUTION

2.01 DEMOLITION IN STRUCTURES AND CONSTRUCTION TO REMAIN

- A. Remove existing construction and equipment including, roofing shingles, and underlayment, on entire roof, plywood decking and fiberglass insulation on Herpetarium side, flashings, sheet metal, blocking as required to complete the installation of new roofing, existing power vents and ridge vent and proper vents as shown or specified.
- B. Coordinate all power vent disconnect and reconnect of new powers vents work with a service technician approved by the unit Manufacturer.
- C. Do not start tear off of existing materials when inclement weather is expected.
- D. Refer to Subsection 1.05 PROTECTION for requirements relating to protection of existing structure and property.
- E. Provide protective devices, enclosures, rails and similar items necessary to provide for normal public passage and to prevent bodily injury to occupants of the building.
- F. Use of the building, or any of its mechanical or electrical systems, shall not be curtailed without prior agreement with the building Owner.
- G. Conduct demolition operations and the removal of debris to ensure minimum interference with roads, walks and other adjacent occupied or used facilities.

- H. If during the course of the demolition work portions of the existing structure are opened to the weather, it shall be the Contractor's responsibility to close such openings as required in a weathertight manner at the end of each work day. The only exception to this will be when the roof is left open for 12 hours for off-gasing of new spray foam insulation, this will be coordinated over an evening when no rain is forecast.

2.02 DISPOSAL OF MATERIALS

- A. All demolition material not schedule for re-use shall be removed from the Owner's site by the Contractor.
 - 1. No prolonged accumulation of debris will be allowed.
 - 2. Remove all salvaged items from the site as demolition progresses. Storage or sale of removed items on the site will not be allowed.
 - 3. The Contractor is responsible for the proper location and method of disposal for each individual component of the roofing system.
 - 4. The site is to be broom clean at the end of each working day.
- B. No burning on site will be permitted.

--- END OF SECTION ---

SECTION 06010

GENERAL CARPENTRY

PART 1 -- GENERAL

1.01 CONDITIONS OF THE CONTRACT

- A. The conditions of the Contract (General, Supplementary, and Other Conditions) and the requirements of Division 1 are hereby made a part of this Section. Applicable provisions of Division 1 shall govern Work under this Section.

1.02 WORK INCLUDED

- A. This Section includes all labor, material, equipment, and related services necessary to perform the following Work:
 - 1. Furnish and install wood framing, bracing, blocking and curbing as required and as shown on the Drawings for installation of new attic separation walls, installation of new fascia, installation of new power vents and installation of new soffit.
 - 2. Furnish and install new 5/8" plywood decking over the entire Herpetarium side.

1.03 RELATED SECTIONS

- A. Section 02070 – Demolition.
- B. Section 07201 - Insulation.
- C. Section 07310 – Asphalt Shingles.
- D. Section 07620 - Sheet Metal Flashing and Trim.
- E. Section 07900 - Sealants.

1.04 QUALITY ASSURANCE

- A. Existing wood members, intended for re-use that are found not to be in satisfactory condition, are to be replaced with equivalent products. Replacement Work shall be by Change Order.
- B. Existing construction may not be as shown on the Drawings and some modification of details may be required to accomplish the intent of the Contract Documents. All modifications or adjustments are to be approved in advance by the Engineer.
- C. No Work of this Section is to be installed unless it can be completely protected from exposure to the weather by the specified flashing the same day Work is installed.
- D. Any grouting, shimming, patching or filling of existing construction required to properly install wood members is the responsibility of the Contractor.

- E. There shall be no deviation made from this Specification or the approved shop drawing without prior written approval by the Engineer.
- F. Shop drawings of proposed alternate details shall be submitted to the Engineer for approval prior to the start of construction.
- G. Proposed alternate details and installation procedures shall comply with the Specifications and Drawings.

1.05 REGULATORY REQUIREMENTS

- A. Materials and construction shall meet the following:
 - 1. Underwriters Laboratories, Inc. (UL): Standards UL 723 and Subject 1040 Conformance.
 - 2. Factory Mutual Engineering Corporation (FM): FM Data Sheets 1-0, 1-1, 1-21, and 1-23; Fire Classification, Class 1 (FM Approval Standards).
 - 3. International Conference of Building Officials, Uniform Building Code (UBC).
 - 4. Regional, State, and Local Building Codes and/or Ordinances.

1.06 SPECIAL CONTRACTOR REQUIREMENTS

- A. The Contractor shall provide a Project Foreman with a minimum of five (5) years documented experience in the supervision of general carpentry and shall be knowledgeable in the type of construction specified herein.
- B. The Contractor's Foreman shall be present on the job site for the entirety of the Work and shall be accessible at all times to ensure good project coordination and communication.
- C. All Work that requires saw cutting, vacuuming, and other similar functions that create substantial noise and/or vibration shall be coordinated well in advance of the Work with the Owner and the Engineer.
- D. Take all necessary precautions to protect the Owner's property as well as adjacent property, including trees, shrubs, buildings, sanitary and storm sewers, water piping, gas piping, electric conduit or cable, etc., from any and all damage which may result due to Work on this Project.

1.07 SUBMITTALS

- A. Submit shop drawings as required. Drawings shall show all other details required for proper lumber installation that are not shown in or that differ from the Specifications and Drawings.
- B. Submit a list of materials (as outlined in 2.02 Materials) for use in the Work.
- C. A total of five (5) copies of each submittal is required.

1.08 PRODUCT DELIVERY, STORAGE AND HANDLING

A. Delivery and Storage of Materials.

1. Deliver all materials in their original unopened containers with all markings intact.
2. Store all materials in a dry place or otherwise protect from water or extreme humidities. Cover with a breathable covering, such as canvas. Covering shall extend to base of stack on all sides.
3. Store cements and adhesives in the manner and temperature range recommended by the individual Manufacturers.

B. Handling Materials

1. Handle materials to avoid bending, breaking or otherwise damaging them during transportation and installation.
2. Do not store materials on the roof in a manner that may exceed the live load capacity of the deck system or the structure. The Engineer, during routine observations, may make recommendations as to loading.
3. Do not transport materials over or store materials on a roof section without prior approval of the Engineer.

1.09 GUARANTEES, WARRANTIES, CERTIFICATES

- A. Materials and/or workmanship shall be guaranteed against all defects for a period of three (3) years from the date of Substantial Completion.

PART 2 -- PRODUCTS

The Contractor is responsible for furnishing the following materials in the amount required for completion of the entire Project specified herein.

2.01 ACCEPTABLE MANUFACTURERS

- A. Provide products by Manufacturers specified herein which meet or exceed standards as set forth in this Section. No materials specified or approved shall contain asbestos.
- B. All materials shall be new unless noted otherwise.

2.02 MATERIALS

- A. Lumber, Nailers and Blocking: Kiln-dried, grade marked, mill tradesmarked according to the National Lumber Manufacturer's Association; Douglas Fir #2 grade or better of Hemlock or White Fir construction grade or better. Lumber stress grade shall be 1,150 psi minimum (E = 1,150 psi). 2 X 4 (minimum) studs required. Moisture content shall be less than 19 percent at the time of installation.

- B. Decking: 5/8" American Plywood Association (APA) exterior rated 4-ply CDX fir, non-preserved treated meeting U.S. Products Standard PS1 or Performance Standard PRP-108 for soft plywood construction. Moisture content shall be less than 19 percent at the time of installation.
- C. Wall sheathing: 5/8" thick gypsum wall board "Sheetrock Brand" as manufactured by USG.
- D. Fasteners: Space fasteners as shown on the Drawings or as specified herein:
 - 1. Nails used to secure lumber to other wood members shall have galvanized metal consistency, and shall be long enough to penetrate 1-1/4". Two rows are required, staggered when feasible. Spacing in any one row shall not exceed 24". Spacing shall not exceed 12", 8' each way from outside corners. Withdrawal resistance shall be 100 pounds per nail minimum. (Lag screws of equivalent strength may be used if desired.)
 - 2. Fasteners used to secure lumber to masonry or concrete shall be 1/2" minimum diameter metal expansion stud anchors in pre-drilled holes such as Kwik-Bolt Stud Expansion Anchor by Hilti, Inc. or approved equal. Space fasteners at 12" o.c. (maximum).
 - 3. Fasteners used to secure plywood to substrate shall be long enough to penetrate 1-1/4". Fasteners shall be spaced 8 inches on center at plywood edges and 12 inches on center in the field of the sheet.
 - 4. Fasteners used to secure metal to metal shall be hardened, self-tapping, sheet metal gimlet point type, with hex/washer head, and be of compatible material. Space fasteners at 12" o.c. (maximum).
- 5. Other fasteners not specifically described shall be as selected by the Contractor subject to approval by the Engineer.
- D. Batt Insulation: ASTM C665, FS HH-I-521E, Type I, nominal 4" thick fibrous glass blanket, designated R-value equals 13. (See Section 07200 - INSULATION.)
- E. Other Materials: All other materials, not specifically described but required for a complete and proper installation of the Work in this Section, shall be as selected by the Contractor subject to approval by the Engineer.

PART 3 -- EXECUTION

3.01 EXAMINATION

- A. The Contractor shall have the sole responsibility for the accuracy of all measurements and for the estimate of material quantities required and necessary to satisfy the requirements of these Specifications.

3.02 SEQUENCING/SCHEDULING

- A. Remove only as much exterior protection as can be restored to a weathertight condition each day or before showers commence.
- B. All contingent flashings shall be completed each day on the worked section.

3.03 SUBSTRATE PREPARATION

- A. Remove existing materials as required to complete the Work.
- B. Install new attic separation walls as indicated on the drawings. Insure all gypsum board seams are "taped" closed with joint compound as recommended by the manufacturer. This includes any open joints in the existing attic separation wall.
- C. Have all surfaces containing mold properly cleaned and treated by a certified mold remediation contractor prior to installation of new materials.

3.04 OTHER REPAIRS AND CONSTRUCTION

- A. Furnish new wooden nailers and blocking for installation areas and applicable details.
- B. Install new lumber in place of existing rotted or otherwise deteriorated lumber not originally scheduled for replacement. Repairs shall be by Change Order.
- C. Assure all existing structural material is sound and secured properly prior to construction. Notify Engineer of any inconsistencies.

3.05 ROUGH CARPENTRY - INSTALLATION

- A. Install new wood members accurately, rigidly framed, closely fitted, plumb and true and securely anchored. Stud spacing shall not exceed 16" in any instance.
- B. Shim and brace Work properly to insure solid bearings and true alignment.
- C. Install all miscellaneous items required to complete installation.
- D. Provide rough openings as required.
- E. Provide wood nailers and/or blocking wherever shown on the Drawings and where required for attachment of other Work. Form to shapes as shown and cut as required for true line and level of Work to be attached. Set true to line, level and plumb with intersections true to required angle, if applicable. Coordinate location with other Work involved.
- F. Install new plywood decking square and true. Leave a space of 1/8" between all plywood sheets at both vertical and horizontal joints. Fastener spacing shall be 8 inches on center at sheet ends and 12 inches on center in the field portion of the sheet.
- G. Attach all Work to substrates securely with fasteners per this Section as required to support applied loading. Countersink fasteners flush with surfaces, unless otherwise shown.

--- END OF SECTION ---

SECTION 07201

INSULATION

PART 1 -- GENERAL

1.01 CONDITIONS OF THE CONTRACT

- A. The conditions of the Contract (General, Supplementary, and Other Conditions) and the requirements of Division 1, are hereby made a part of this Section. Applicable provisions of Division 1 shall govern the Work under this Section.

1.02 WORK INCLUDED

- A. This Section includes all labor, material, equipment and related services necessary to perform the following Work:
 - 1. Furnish and install new spray foam insulation on the Herpetarium side.
 - 2. Furnish and install new proper vents within entire attic area.
 - 3. Evenly redistribute existing fiberglass insulation on Discovery side.
 - 4. Furnish and install 1200 cubic feet (approximately 5 new inches) of new blown in fiberglass on Discovery side.

1.03 RELATED SECTIONS

- A. Section 02070 - Demolition.
- B. Section 06010 – General Carpentry.
- C. Section 07310 – Asphalt Shingles.
- D. Section 07620 - Sheet Metal Flashing and Trim.
- E. Section 07900 - Sealants.

1.04 QUALITY ASSURANCE

- A. The Insulation Manufacturer shall have a minimum ten (10) years experience specializing in roof insulations.
- B. The Contractor shall have a minimum five (5) years documented experience specializing in installing insulation systems.
- C. The insulation system must be applied by a Contractor authorized by the Insulation System Manufacturer.
- D. All components used in the insulation system shall be approved by the Insulation Manufacturer.

- E. There shall be no deviation made from this Specification or the approved shop drawings without prior written approval by the Manufacturer and Engineer.
- F. Shop drawings of proposed alternate details shall be submitted to the Engineer for approval two weeks prior to the start of construction.
- G. Proposed alternate details and application procedures shall comply with the Specifications, Drawings, and Manufacturer's recommendations.
- H. The Contractor shall keep a copy of the Insulation Manufacturer's installation instructions and these Specifications on site at all times.

1.05 REGULATORY REQUIREMENTS

- A. Materials and construction shall meet the following:
 - 1. Underwriters Laboratories, Inc. (UL): Class A Fire Hazard Classification.
 - 2. Factory Mutual Engineering Corporation (FM): Windstorm Resistance Classification, FM Data Sheets 1-28 (September, 1991 Revision) and 1-49 (Class I-90 Construction); Fire Classification, Class 1 (FM Approval Standards).
 - 3. International Conference of Building Officials, Uniform Building Code (UBC).
 - 4. Regional, State, and Local Building Codes and/or Ordinances.

1.06 REFERENCES

- A. References shall refer to the most recent standard.
 - 1. American Society for Testing and Materials (ASTM).
 - 2. Federal Specifications (FS).
 - 3. Factory Mutual Engineering Corporation (FM).

1.07 SPECIAL CONTRACTOR REQUIREMENTS

- A. The Contractor shall provide a Project Foreman with a minimum of five (5) years documented experience in the supervision of insulation system installation and shall be knowledgeable in the type of insulation system specified herein.
- B. The Contractor shall not change Foreman or crew without prior approval of the Engineer.
- C. The Contractor's Foreman shall be present on the job site during the majority of work hours and shall be accessible at all times to ensure good Project coordination and communication.

- D. During the workday should the weather conditions appear to be changing adversely, the Foreman shall take preventative measures to allow the roof to be closed to a watertight condition to avoid exposure of buildings, equipment and materials.
- E. All Work that requires saw cutting, vacuuming and other similar functions that create substantial noise and/or vibration shall be coordinated well in advance of the Work with the Owner and the Engineer.
- F. Prior to the start of the Project, and daily after the start, the Contractor shall review the type of space below the roof being worked on to ensure that all special requirements because of occupancy type are complied with prior to the start of the Work.
- G. Take all necessary precautions to protect the Owner's property as well as adjacent property, including trees, shrubs, buildings, sanitary and storm sewers, water piping, gas piping, electric conduit or cable, etc., from any and all damage which may result due to Work on this Project.
- H. Temporarily pressurize the building prior to removing the plywood decking and installation of the spray foam insulation begins.
- I. Maintain the pressure system and keep the roof deck open for a period of 12 hours after the installation of the spray foam is complete.
- J. Repair any Work, damaged by failure to provide proper and adequate protection, to its original state to the satisfaction of the Owner or remove and replace with new Work at the Contractor's expense.

1.08 SUBMITTALS

- A. Submit shop drawings as required. Drawings shall show details required for proper insulation system installation that are not shown in or that differ from the Specifications and Drawings.
- B. Submit a list of materials for use in the Work.
- C. Submit product data for the insulation system(s).
- D. Submit Insulation Manufacturer's installation instructions.
- E. A total of four (4) copies of each submittal is required.

1.09 PRODUCT DELIVERY, STORAGE AND HANDLING

- A. Deliver all materials in Manufacturer's original, unopened containers with Manufacturer's labels intact and legible.
- B. Stack insulation at least 4" above the ground on pallets and cover with a breathable covering, such as canvas. The covering shall extend to grade on all sides. Protect foam insulations from direct exposure to sunlight. Translucent plastic wrap as provided by the Manufacturer for shipping will not constitute adequate protection.

- C. Materials shall be stored so as to protect them completely from damage by the elements and temperatures. Storage of materials on ground and/or rooftop shall be protected with waterproof canvas covering and stored on raised platforms. The use of pallets or similar type equipment will be acceptable.
 - 1. Waterproof canvas covering shall be applied in a watertight manner and securely tied at the end of each work day or work period.
 - 2. Use of the Manufacturer's product protection wrapping is not acceptable for worksite type protection. Wrapping shall be side-punctured or end-punctured or slashed before covering with canvas.
 - 3. No tears in the waterproof canvas covering will be allowed.
- D. Material storage in warehouse, storage trailer, or tent is recommended.
- E. Keep lids tightly sealed on all emulsions, solvent based adhesives, and cements to keep volatiles from escaping.
- F. Handling Materials
 - 1. Do not store or transport insulation materials on the roof in a manner that may exceed the live load capacity of the deck system or the structure. The Engineer, during routine observations, may make recommendations as to loading.
 - 2. Do not transport insulation materials over or store materials on a finished section, without prior approval from the Engineer.

1.10 ENVIRONMENTAL REQUIREMENTS

- A. Do not apply insulation during inclement weather or when air temperature is below (or is expected to be below) 60°F.

1.11 GUARANTEES, WARRANTIES, CERTIFICATES

- A. Furnish two copies of the following to the Engineer:
 - 1. Manufacturers System Warranty: The Contractor shall warrant, in writing, all insulation materials for a period of twenty (10) years following completion and that the insulation system has been installed according to material Manufacturer's current specifications. The warranty shall cover labor and materials.

PART 2 -- PRODUCTS

The Contractor is responsible for furnishing the following materials in the amount required for completion of the entire Project specified herein.

2.01 ACCEPTABLE MANUFACTURERS

- A. Provide products by Manufacturers specified herein which meet or exceed standards as set forth in this Section. No materials specified or approved shall contain asbestos.
- B. All materials shall be new unless otherwise noted.

2.02 MATERIALS

- A. Insulation
 - 1. Sprayed in place Foam:
 - a. Low VOC sprayed polyurethane foam conforming to ASTM E 84, E 2178 and C 518. Sprayed to a minimum thickness of 5 inches. "Icynene Proseal HFO" as manufactured by Icynene Lopalla.
- B. Fasteners (Miscellaneous):
 - 1. Nails used to secure wood such as fascias, cant strips, blocking and nailers to other wood members shall be galvanized and long enough to penetrate 1-1/4". Two rows are required, staggered when feasible. Spacing in any one row shall not exceed 24". Spacing shall not exceed 12", 8' each way from outside corners. Withdrawal resistance shall be 100 pounds per nail minimum. (Lag screws of equivalent strength may be used if desired.)
 - 2. Fasteners used to secure lumber to masonry or concrete shall be 1/2" minimum diameter metal expansion stud anchors in pre-drilled holes such as "Kwik-Bolt II Stud Expansion Anchor" by Hilti, Inc. or as approved by Architect/Engineer. Space fasteners at 12" o.c. (maximum).
 - 3. Other fasteners not specifically described shall be as selected by the Contractor subject to approval by the Engineer. All fasteners shall meet the requirements set forth in FM Data Sheet 1-28 and 1-49 as appropriate.
- G. Flame Resistant Foil Faced Building Insulation: ASTM C665, Type III, Class A fiberglass blanket such as "FSK-25" by CertainTeed or as approved by Architect/Engineer.
- H. Plywood: (Thickness as shown on the Drawings) APA exterior rated 4-ply CDX.
- I. Fiberglass Insulation: Pro Pink L77 Pink Unbonded Loose Fill as manufactured by Owens Corning or approved equal.
- J. Gypsum Wall Board: 5/8" thick 4' x 8' Gypsum panel, SheetRock Brand as manufactured by USG.
- K. Other Materials: All other materials, not specifically described but required for a complete and proper installation of the Work in this Section, shall be as selected by the Contractor subject to approval by the Engineer.

PART 3 – EXECUTION

3.01 DEFINITIONS

- A. The term “phased construction” or “phased application” shall mean the insulation system construction or application process in which all parts of cross-section of a roofing system, including the vapor retarder, roof insulation, roof decking and surfacing are not completed for a particular roof area during one day or work period.

3.02 EXAMINATION

- A. The Contractor shall have the sole responsibility for the accuracy of all measurements and for the estimate of material quantities required and necessary to satisfy the requirements of these Specifications.

3.03 SUBSTRATE PREPARATION

- A. Pressurize building and remove the existing shingles, underlayment, decking and fiberglass insulation on the Herpetarium side as shown on the drawings (as described in Section 02070 - Demolition).
- B. Repair any damaged or displaced poly vapor retarder and position new proper vents between all truss spaces.
- C. Install foam stops as needed.

3.04 WORKMANSHIP

- A. All insulation Work shall be accomplished with non-working Foreman overseeing the work of workers who are thoroughly skilled in the application of specified materials. All workmanship to be of the very best, and shall be done in such a manner as to fulfill the requirements of the Drawings and Specifications.
- B. Weather Condition Limitations: Proceed with insulation Work only when existing and forecasted weather conditions will permit Work to be performed in accordance with the requirements of this Specification.
- C. After starting the Work, the Contractor shall be responsible for complete moisture integrity of the insulation system. The occupancy requires that the roof deck be left open for a period of 12 hours after the spray foam installation is complete, Therefore, the Contractor shall:
 - 1. Establish and follow application procedures to insure that adequate quantities of materials are used and installed in one afternoon.

2. Maintain competent Foreman continuously supervising the Work, with authority to discard unsuitable materials and remove unsatisfactory workmen from the Project.
 3. Observe all fire precautions involving the storage and handling of insulation materials. Provide adequate quantity of fire extinguishers at the worksite, especially at the kettles, torches, or open flames.
 4. Comply with current insulation safety standards at all times.
 5. Under no conditions shall any insulation materials be applied before sunrise, or at anytime when there are indications of moisture present (rain, mist, dew, frost, and snow) for a period of 12 hours.
 6. At the end of the 12 hour off gasing period the contractor shall immediately install new roof decking, ice dam protection and shingle underlayment to return the facility to a watertight state.
 7. Comply with other workmanship requirements as outlined in other Sections of this Specification.
- D. The following cold weather (below 60°F) precautions shall be followed when applying the roof insulation system to insure proper performance of this Specification.
1. Store materials in a heated environment up to one hour immediately prior to installation.

3.05 OTHER REPAIRS AND CONSTRUCTION

- A. Furnish new wood nailers and blocking for roof installation areas and details applicable.
- B. Install new lumber in place of existing rotted or otherwise deteriorated lumber not originally scheduled for replacement. Repairs shall be by Change Order.
- C. Install new fascia board at all perimeter areas.
- D. Assure all existing structural material is sound and secured properly prior to construction. Notify the Engineer of any inconsistencies.

3.06 Fiberglass Insulation- Installation Discovery Side:

1. Remove all existing proper vents and install new proper vents as indicated on the drawings.
2. Redistribute existing fiberglass insulation.
3. Install new, minimum 5 inches thick, blown in fiberglass insulation per manufacturers instructions.

4. Remove existing soffit panel on east end of Discovery side and replace it with new to match existing material without the vent opening.

--- END OF SECTION ---

SECTION 07310
ASPHALT SHINGLES

PART 1 -- GENERAL

1.01 CONDITIONS OF THE CONTRACT

- A. The conditions of the Contract (General, Supplementary and Other Conditions) and the requirements of Division 1, are hereby made a part of this Section. Applicable provisions of Division 1 shall govern Work under this Section.

1.02 WORK INCLUDED

- A. This Section includes all labor, material, equipment and related services necessary to perform the following Work:
 - 1. Furnish and install new fully adhered ice dam protection membrane.
 - 2. Furnish and install new mechanically attached shingle underlayment.
 - 3. Furnish and install new asphalt shingles.
 - 4. Furnish and install new power vents as shown on the drawings.
 - 5. Coordinate the installation of new metal Work incidental to the roofing Work.
 - 6. Repair or replace existing deck areas that are damaged or deteriorated.

1.03 RELATED SECTIONS

- A. Section 02070 - Demolition.
- B. Section 06010 – General Carpentry.
- C. Section 07201 - Insulation.
- D. Section 07620 - Sheet Metal Flashing and Trim.
- E. Section 07900 - Sealants.

1.04 QUALITY ASSURANCE

- A. The shingle Manufacturer shall have a minimum twenty (20) years experience specializing in shingle roof systems.
- B. The Contractor shall have a minimum ten (10) years documented experience specializing in shingle roof application.
- C. The roof system must be applied by a roofing Contractor authorized by the roof system Manufacturer.
- D. The shingle Manufacturer shall approve all components used in the roof system.
- E. At the start of new roof installation, Manufacturer's Representative shall visit the job site to ensure

SECTION 07310
ASPHALT SHINGLES

that the installation begins correctly with all installation procedures and guidelines being followed and notify the Engineer of his findings. Failure to notify hereby constitutes acceptance of the Work of his licensed applicator (the Contractor) by the Manufacturer.

- F. Upon 50 percent completion of the Project, the roof membrane Manufacturer's Representative shall inspect the installation for adherence to installation procedures and guidelines. The installation shall be inspected more frequently if deemed necessary by the Manufacturer, Engineer, Owner or Contractor.
- G. Upon completion of the installation, an inspection shall be made by a representative of the roof membrane Manufacturer to ascertain that the roof system has been installed according to the applicable roof membrane Manufacturer's specifications.
- H. All the above indicated job visits shall be documented in writing by the shingle Manufacturer's Representative indicating all problems, concerns, recommendations and directives given to the roofing Contractor regarding roof system installation. Copies shall be provided to Engineer within ten (10) days of the inspection date.
- I. It is the roofing Contractor's responsibility to arrange the Manufacturer's inspections.
- J. There shall be no deviation made from this Specification or the approved shop drawing without prior written approval by the Manufacturer and Engineer.
- K. Shop drawings of proposed alternate details shall be submitted to the Engineer for approval prior to the start of construction.
- L. Proposed alternate detail and application procedures shall comply with Specification, Drawings and Manufacturer's recommendations.
- M. The Contractor shall keep a copy of the shingle Manufacturer's installation instructions and these Specifications on site at all times.

1.05 REGULATORY REQUIREMENTS

- A. Materials and construction shall meet the following:
 - 1. Underwriters Laboratories, Inc. (UL): Class A Fire Hazard Classification.
 - 2. Factory Mutual Engineering Corporation (FM): Windstorm Resistance Classification, FM Data Sheets 1-28 (September, 1991 Revision) and 1-49 (Class I-90 Construction); Fire Classification, Class 1 (FM Approval Standards).
 - 3. International Conference of Building Officials, Uniform Building Code (UBC).
 - 4. Regional, State, and Local Building Codes and/or Ordinances.

1.06 REFERENCES

- A. References shall refer to the most recent standard.
 - 1. American Society for Testing and Materials (ASTM).

SECTION 07310
ASPHALT SHINGLES

2. Federal Specifications (FS).
3. Factory Mutual System (FM).

1.07 SPECIAL ROOF CONTRACTOR REQUIREMENTS

- A. The Contractor shall provide a Project Foreman with a minimum of tens (10) years documented experience in the supervision of roof system installation and shall be knowledgeable in the type of roof system specified herein.
- B. The Contractor shall not change the Foreman or crew without prior approval of the Engineer.
- C. The Contractor's Foreman shall be present on the job site during the majority of work hours and shall be accessible at all times to ensure good project coordination and communication.
- D. During the workday should the weather conditions appear to be changing adversely, the Foreman shall take preventative measures to allow the roof to be closed to a watertight condition to avoid exposure of buildings, equipment and materials.
- E. All Work that requires saw cutting, vacuuming and other similar functions that create substantial noise and/or vibration shall be coordinated well in advance of the work with the Owner and Engineer.
- F. Prior to the start of any roof project, and daily after the start, the Contractor shall review the type of space below the roof being worked on to ensure that all special requirements because of occupancy type are complied with prior to the start of the Work.
- G. Take all necessary precautions to protect the Owner's property as well as adjacent property, including trees, shrubs, buildings, sanitary and storm sewers, water piping, gas piping, electric conduit or cable, etc., from any and all damage which may result due to work on this Project.
- H. Repair any Work, damaged by failure to provide proper and adequate protection, to its original state to the satisfaction of the Owner or remove and replace with new Work at the Contractor's expense.

1.08 SUBMITTALS

- A. Submit shop drawings as required. Drawings shall show roof edge condition details, roof penetration flashing details, standard roof section and all other details required for proper roof system installation that are not shown in or that differ from the Specification and Drawings.
- B. Submit a list of materials for use in the Work.
- C. Submit product data for membrane and base flashing with temperature range for application of membrane.
- D. Submit membrane Manufacturer's installation instructions.
- E. A total of three (3) copies of each submittal is required.

1.09 PRODUCT DELIVERY, STORAGE AND HANDLING

SECTION 07310
ASPHALT SHINGLES

- A. Deliver all materials in Manufacturer's original, unopened containers with Manufacturer's labels intact and legible.
- B. Materials shall be stored so as to protect them completely from damage by the elements and temperatures. Storage of materials on ground and/or rooftop shall be protected with waterproof (canvas) covering and stored on raised platforms. The use of pallets or similar type equipment will be acceptable.
 - 1. Store cements, primers and Sealants between 40°F and 80°F. Should they be exposed to low temperatures, return to room temperature for several days prior to use.
 - 2. Waterproof (canvas) covering shall be applied in a watertight manner and securely tied at the end of each workday or work period.
 - 3. Use of Manufacturer's product protection wrapping is not acceptable for worksite type protection. The wrapping shall be side-punctured or end-punctured or slashed before covering with canvas.
 - 4. No tears in the waterproof (canvas) covering will be allowed.
- C. Material storage in warehouse, storage trailer or tent is recommended.
- D. Keep lids tightly sealed on all emulsions, solvent-based adhesives, and cements to keep volatiles from escaping.
- E. Stir adhesives thoroughly before using. Use mechanical methods of stirring; hand stirring with a paddle will not be acceptable.

1.10 ENVIRONMENTAL REQUIREMENTS

- A. Do not apply ice dam protection, underlayment or shingles during inclement weather or when air temperature is below (or is expected to be below) 40°F (5°C).
- B. Do not start tear off of existing materials when inclement weather is expected.

1.11 GUARANTEES, WARRANTIES, CERTIFICATES

- A. Furnish two copies of the following to the Engineer:
 - 1. Contractor's Warranty: The Contractor shall warrant, in writing, that the roof system shall remain leak free for a period of five (5) years following completion and that the roof system has been installed according to material Manufacturer's current specifications. The warranty shall cover labor and materials.
 - 2. Shingle Manufacturer's Roof System Warranty: The shingle Manufacturer shall furnish an Original Cost of Installation of Manufacturer's Materials Roofing Guarantee. The guarantee shall include the costs of repairs or replacement of both the shingles and the underlayment damaged as a result of the shingle failure and necessary to stop leaks which occur during a period of twenty (20) years from the date of completion, as a result of workmanship or deterioration of the shingle and underlayment system. Membrane Manufacturer's Owner

SECTION 07310
ASPHALT SHINGLES

Service Manual: Provide for the Owner an informational manual to include Manufacturer's approved emergency repair procedures and materials, maintenance procedures and customer service information.

PART 2 -- PRODUCTS

The Contractor is responsible for furnishing the following materials in the amount required for completion of the entire Project specified herein.

2.01 ACCEPTABLE MANUFACTURERS

- A. Provide products by Manufacturers specified herein which meet or exceed standards as set forth in this Section. No materials specified or approved shall contain asbestos.
- B. All materials shall be new unless noted otherwise.

2.02 MATERIALS

- A. Shingles: Asphalt based, fiberglass reinforced, UL Class A rated, UL 997 Wind Resistance, ASTM D 7158, Class H ASTM D 3161 Type 1, ASTM D 3018 Type 1, ASTM D 3462, AC438 compliant, self sealing, granule surfaced "Timberline Natural Shadow Lifetime" as manufactured by GAF. Standard color to be selected by owner.
- B. Starter Strips: Self-sealing starter shingle "WeatherBlock Eave/Rake Starter Strip" as manufactured by GAF.
- C. Ice Dam Barrier: Self-sealing, self-adhering, skid resistant bituminous sheet "WeatherWatch Leak Barrier as manufactured by GAF.
- D. Underlayment: UV stabilized polypropylene, breathable, non asphaltic ASTM D226 and D4869 "Deck-Armor Premium Breathable Roof Deck Protection" as manufactured by GAF.
- E. Plastic Cement: Asphalt plastic roof cement meeting ASTM D 4586 Type I or II.
- F. Fasteners:
 - 1. Roof Nails: Standard round wire, zinc-coated steel or aluminum, 10 to 12 gauge, smooth, barbed or deformed shank, with 3/8 to 7/16 diameter heads. Length must penetrate at least 3/4" into solid wood or through plywood by at least 1/8:
 - 2. Nails used to secure wood such as fascias, cant strips, blocking and nailers to other wood members shall be galvanized and long enough to penetrate 1-1/4". Two rows are required, staggered when feasible. Spacing in any one row shall not exceed 24". Spacing shall not exceed 12", 8' each way from outside corners. Withdrawal resistance shall be 100 pounds per nail minimum. (Lag screws of equivalent strength may be used if desired.)
 - 3. Fasteners used to secure lumber to masonry or concrete shall be 1/2" minimum diameter metal expansion stud anchors in pre-drilled holes such as Kwik-Bolt II Stud Expansion Anchor by Hilti, Inc. or approved equal. Space fasteners at 12" o.c. (maximum).
 - 4. Fasteners used to secure metal to metal shall be hardened, self-tapping, sheet metal gimlet point

SECTION 07310
ASPHALT SHINGLES

type, with hex/washer head and be of compatible material.

5. Other fasteners not specifically described shall be as selected by the Contractor subject to approval by the Engineer. All fasteners shall meet the requirements set forth in FM Data Sheets 1-28 and 1-49 as appropriate.
6. Proper Vents: ADO Products Durovent Baffle, 25.3 square inch minimum free area.
7. Power Vents: Herpetarium Side: AirVent Model PL12 1170 CFM. Discovery Side: AirVent Model HE 15 1500 CFM

PART 3 -- EXECUTION

3.01 DEFINITIONS

- A. Bond: The adhesive and cohesive forces holding two roofing components in intimate contact.
- B. The term “phased construction” or “phased application” shall mean the roofing system construction or application process in which all parts of cross-section of a roofing system, ice dam protection, roof underlayment and roof shingles are not completed for a particular roof area during one day or work period.

3.02 EXAMINATION

- A. The Contractor shall have the sole responsibility for the accuracy of all measurements and for the estimate of material quantities required and necessary to satisfy the requirements of these Specifications.

3.03 WORKMANSHIP

- A. All roofing work shall be accomplished with a Foreman overseeing the work of the crew who are thoroughly skilled in the application of specified materials. All workmanship to be of the very best and shall be done in such a manner as to fulfill the requirements of the Drawings and Specifications.
- B. Weather Condition Limitations: Proceed with roofing work only when existing and forecasted weather conditions will permit work to be performed in accordance with the requirements of this Specification.
- C. After starting the Work, the Contractor shall be responsible for complete moisture integrity of the roofing and flashing membrane and for providing a properly applied roof. Therefore, the Contractor shall:
 1. Establish and follow application procedures to insure that adequate quantities of materials are used.
 2. Maintain competent Foreman continuously supervising the Work, with authority to discard unsuitable materials and remove unsatisfactory workmen from the Project.
 3. Observe all fire precautions involving the storage and handling of roofing materials. Provide adequate quantity of fire extinguishers at worksite.

SECTION 07310
ASPHALT SHINGLES

4. Comply with current roofing safety standards at all times.
 5. Supervise installation of and be responsible for seeing that roof mechanical and electrical equipment, are properly set without damage to the roof.
 6. Under no conditions shall any roofing materials be applied before sunrise, or at anytime when there are indications of moisture present (rain, mist, dew, frost, and snow).
 7. Install only as much roofing material as can be completed and covered in accordance with the requirements of this Specification in any one day or work period.
 8. The Contractor shall install flashing at openings, projections and walls adjoining new roofing every day or work period. If circumstances do not allow this, these areas shall be made watertight at the end of each day or work period.
 9. Comply with other workmanship requirements as outlined in other Sections of this Specification.
- D. The following cold weather (below 40°F) precautions shall be followed when applying the ice dam protection to insure proper performance of this Specification.

3.04 PREPARATION OF SUBSTRATE

- A. Clean all deck surfaces prior to installation of leak barrier and underlayment.
- B. At areas to receive ice dam protection, fill know holes and cracks with latex filler.
- C. Insure that deck is smooth and level, free of moisture and debris.

3.05 ICE DAM PROTECTION INSTALLATION

- A. Install new metal drip edge tight to back of gutter, lap joints 3 inches.
- B. Install two rows of Ice dam protection starting ¼' back from the outside lip of the sheet metal drip edge. Lap the second row onto the first row 3 inches. Lap ends 6 inches.
- C. Install the ice dam protection straight and true with no wrinkles or fish mouths per Manufacturer's requirements.

3.06 UNERLAYMENT INSTALLATION

- A. Install underlayment over ice dam protection and plywood deck, laping each row 3 inches, with 6 inch end laps.
- B. Fasten side and end laps at 6 inches on center, fasten middle of roll and 12 inches on center. For extended exposure to rain or high winds, completely cover all side and end laps and fasteners with tape.

SECTION 07310
ASPHALT SHINGLES

- C. Install underlayment straight and true with no wrinkles for fish mouths per manufactures recommendations.
- D. At roof penetrations, install ice dam barrier over underlayment and seal onto penetration. The barrier should lap onto the penetration 2 inches and onto the underlayment 6 inches.

3.06 SHINGLE INSTALLATION

- A. Avoid breaking shingles in cold weather, do not drop bundles or break them over the ridge and handle carefully when temperatures approach 40 degrees.
- B. Handle carefully in hot weather and avoid traversing completed areas to avoid damaging shingle surface.
- C. Secure shingles with 6 nails per shingle, nails must penetrate deck at least 1/8". Nail no closer than 6 inches to a valley.
- D. Place the nails in the location designated by the manufacturer.
- E. Place the shingles with course staggering as recommended by the manufacturer. Racking of the shingles will not be allowed.
- F. Install the shingles straight and true, with the manufacturers recommended exposure.
- G. Stage the work so that traffic over completed roofing is minimized.

--- END OF SECTION ---

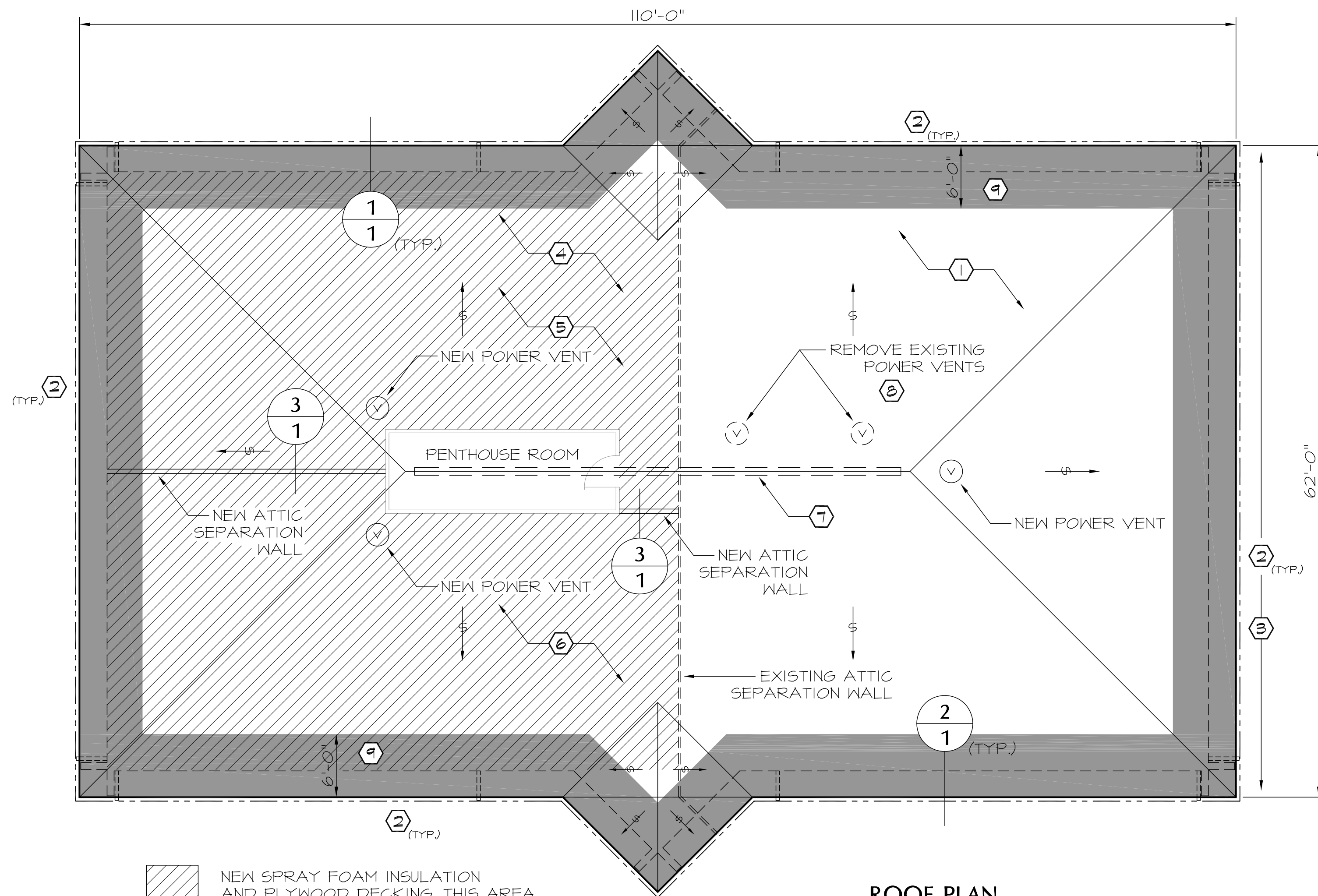

ROOF PLAN
SCALE: 1/8"=1'-0"

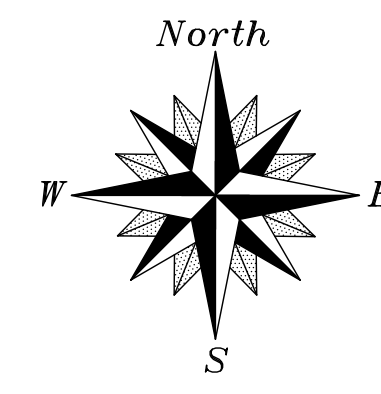

GENERAL NOTES:

1. CONTRACTOR IS RESPONSIBLE FOR THE VERIFICATION OF ALL DIMENSIONS AND EXISTING DETAILS AND CONDITIONS PRIOR TO SUBMITTING BID AND STARTING WORK.
2. DETAILS SHOWN REPRESENT EXISTING CONDITIONS TO THE EXTENT KNOWN, WITH THE NEW MATERIALS AND/OR PROCEDURES CALLED OUT.
3. CONTINUOUS EPDM SHEETS, WHEREVER SPECIFIED, SHALL BE BONDED AT ALL LAPS.
4. INSULATION SHALL BE TAPERED TO DRAIN OPENINGS, FROM ITS CLAMPING RING AND ON ALL SIDES.
5. ALL DAMAGED OR MISSING ROOF DRAIN ASSEMBLY COMPONENTS ARE TO BE REPLACED WITH NEW.

DESIGN NOTES:

1. EVENLY REDISTRIBUTE EXISTING FIBERGLASS INSULATION ON DISCOVERY SIDE OF SEPARATION WALL.
2. INSTALL NEW PROPER VENTS BETWEEN EACH JOIST.
3. REMOVE EXISTING SOFFIT ON EST SIDE OF BUILDING AND INSTALL NEW TO MATCH EXISTING MATERIAL. NEW SOFFIT SHALL HAVE NO VENTING.
4. REMOVE AND REPLACE EXISTING 5/8" PLYWOOD DECKING ON HERPETARIUM SIDE WITH NEW TO MATCH EXISTING. THIS HAS TO BE COORDINATED TO ALLOW REMOVAL OF EXISTING FIBERGLASS INSULATION AND INSTALLATION OF NEW SPRAY FOAM.
5. INSTALL NEW 5" THICK SPRAY FOAM INSULATION ON HERPETARIUM SIDE.
6. CLEAN AND TREAT ALL EXISTING STRUCTURAL MEMBERS TO ELIMINATE ANY SIGNS OF MOLD.
7. REMOVE EXISTING RIDGE VENT AND FILL IN DECKING ON DISCOVERY SIDE. NEW ROOF NOT TO HAVE A RIDGE VENT.
8. REMOVE ALL EXISTING POWER VENTS. FILL IN DECKING ON DISCOVERY SIDE.
9. INSTALL (2) ROWS OF ICE-AND-WATER SHIELD AT ENTIRE PERIMETER.

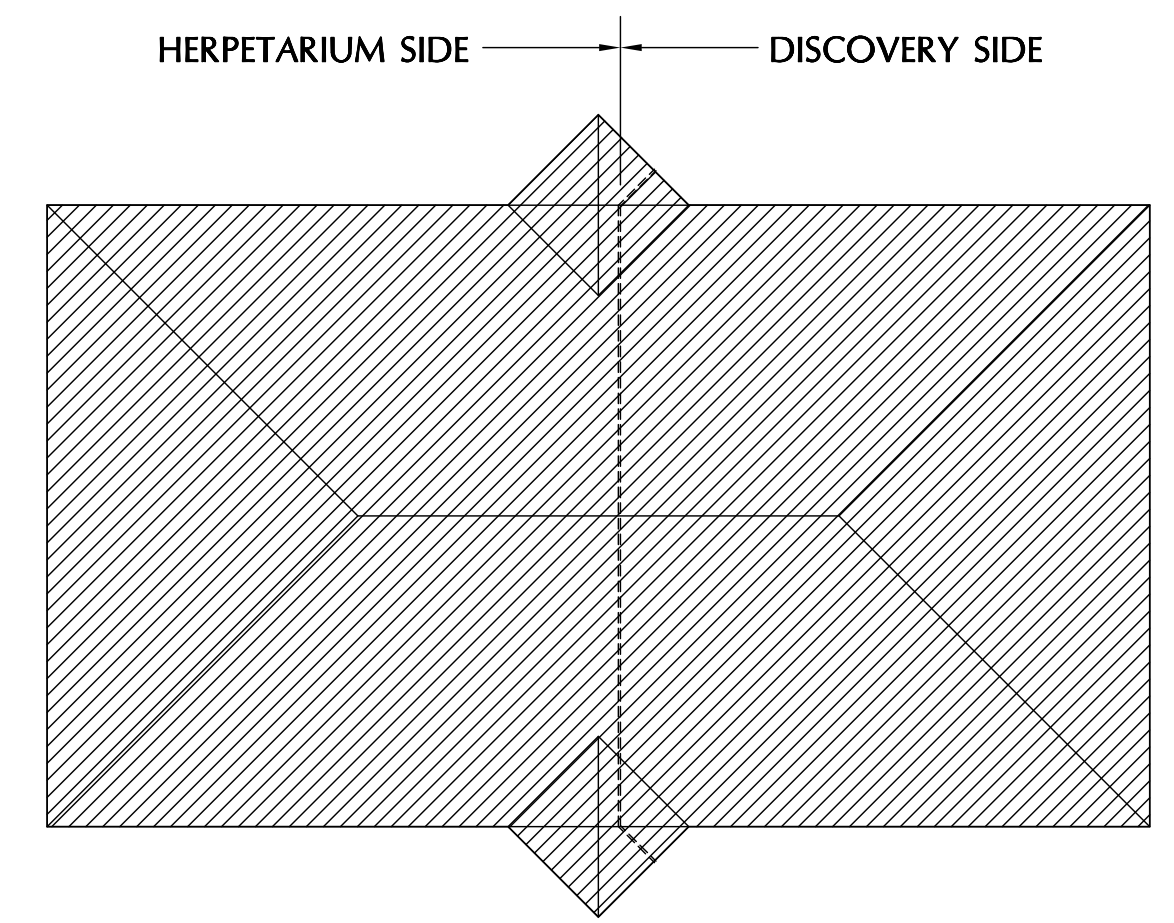

KEY PLAN
SCALE: NONE

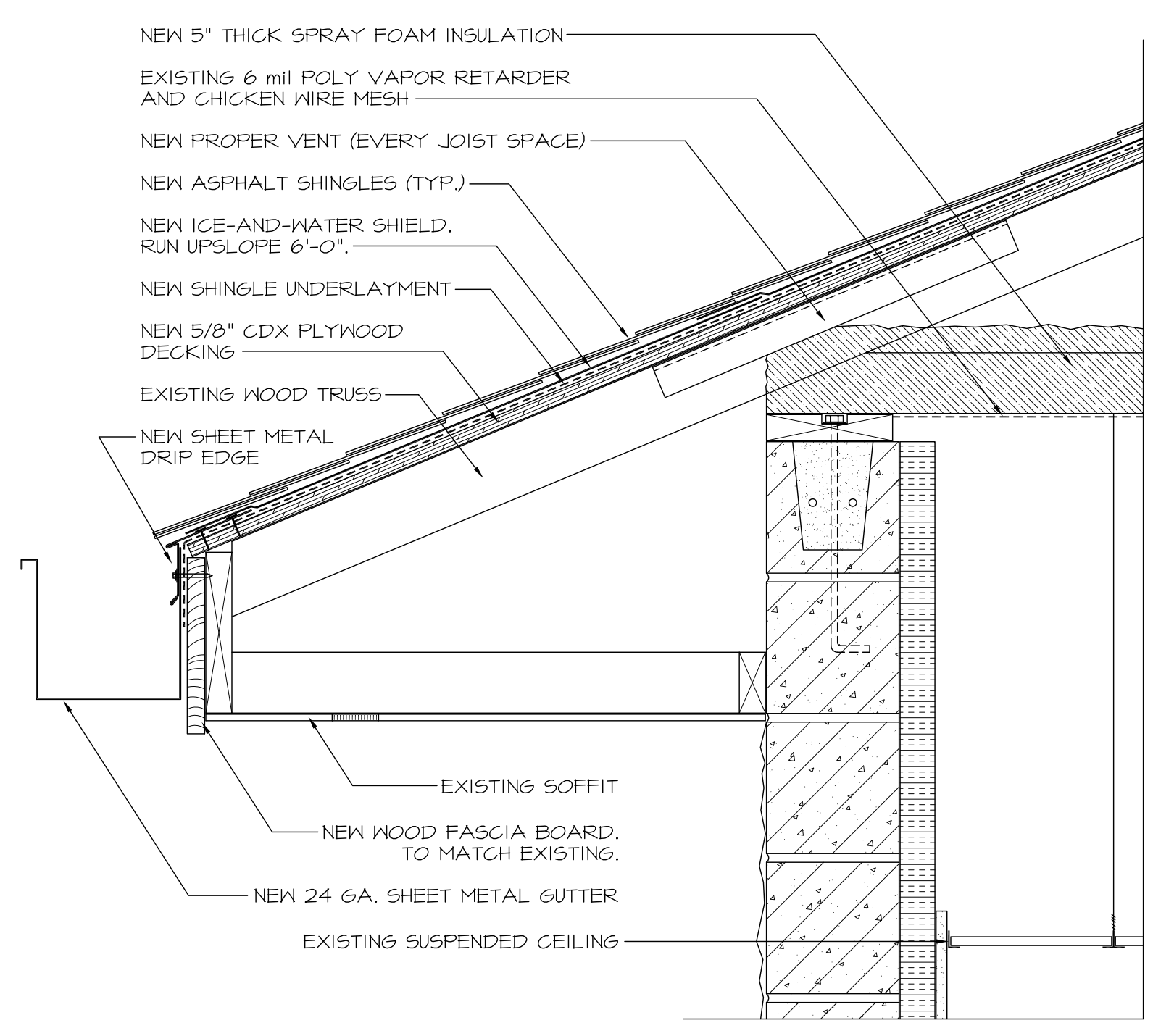

1 ROOF EAVE/GUTTER EDGE - HERPETARIUM SIDE
SCALE: 1-1/2"=1'-0"

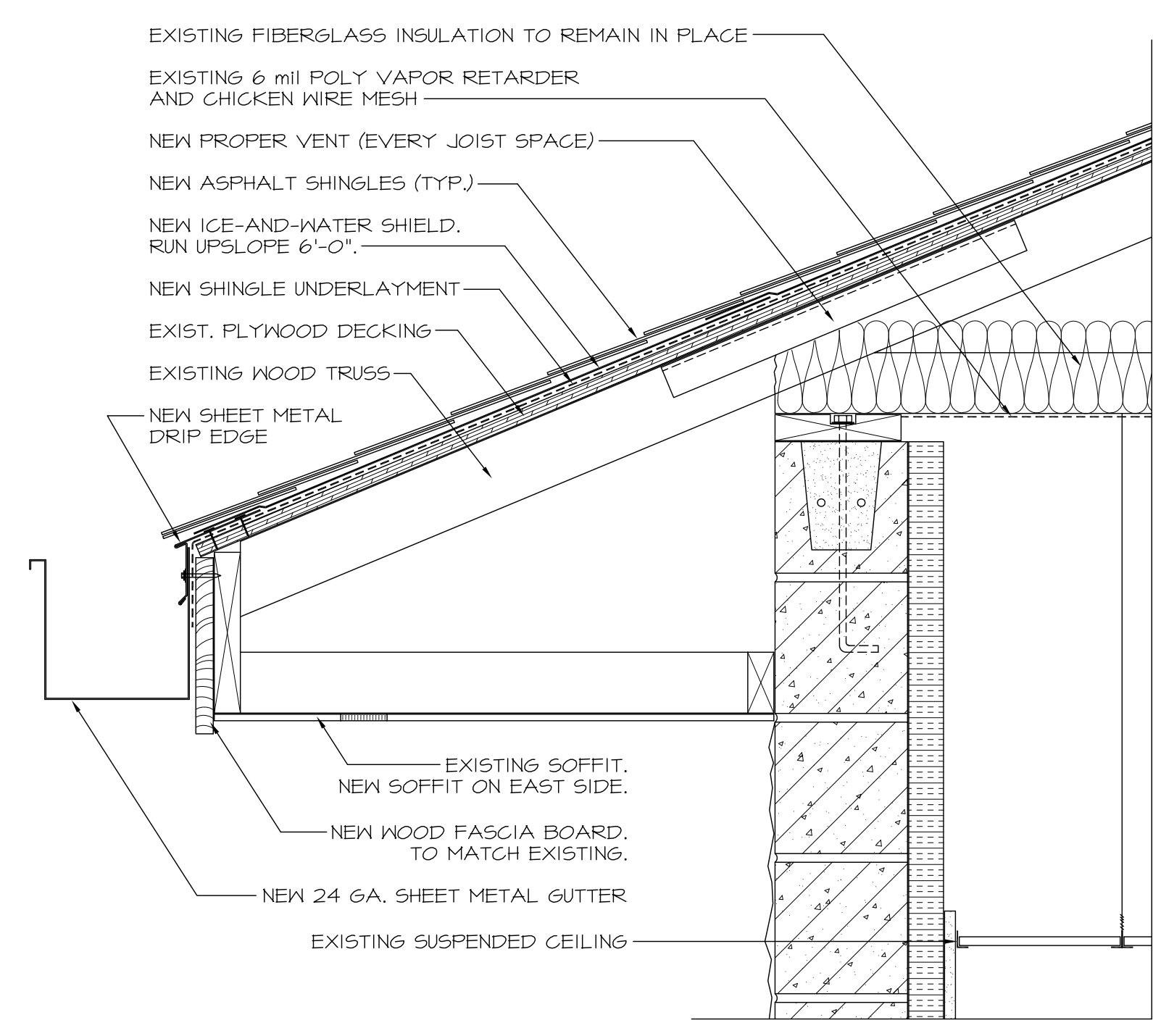

2 ROOF EAVE/GUTTER EDGE - DISCOVERY SIDE
SCALE: 1-1/2"=1'-0"

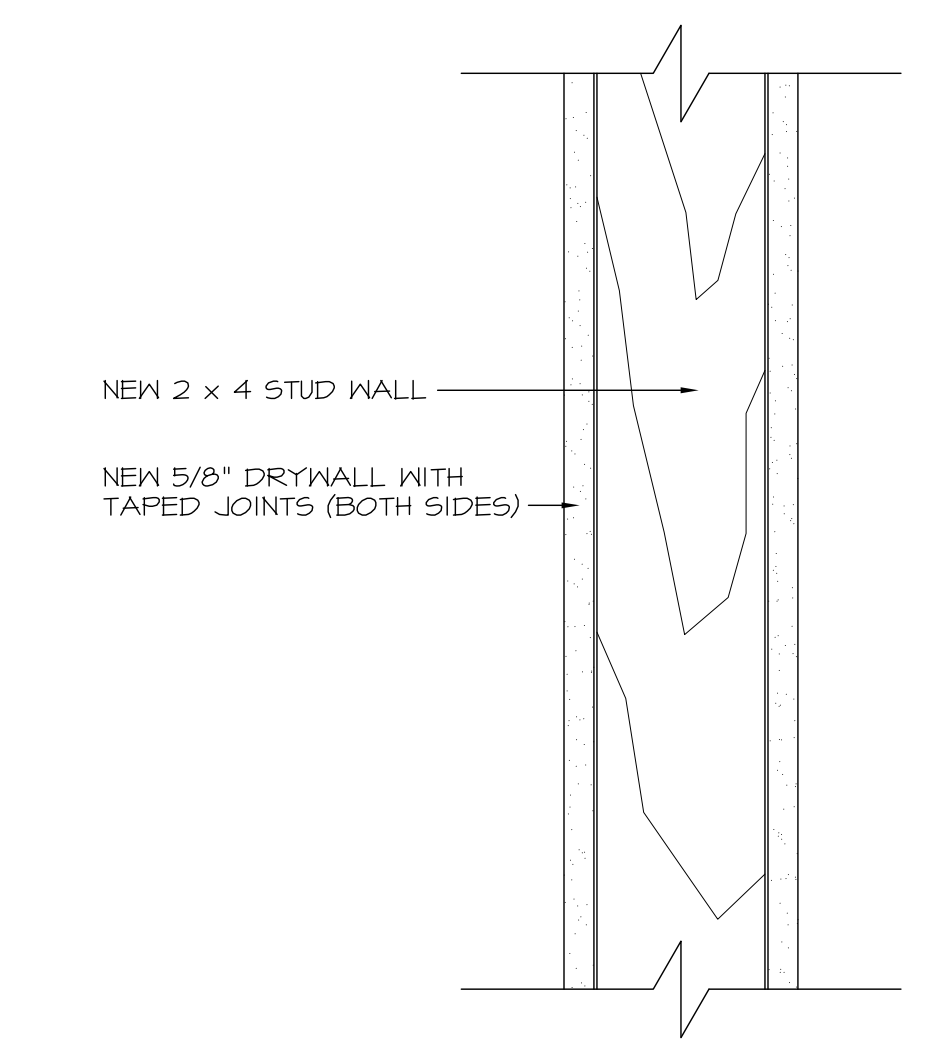

3 NEW ATTIC SEPARATION WALL
SCALE: 3"=1'-0"

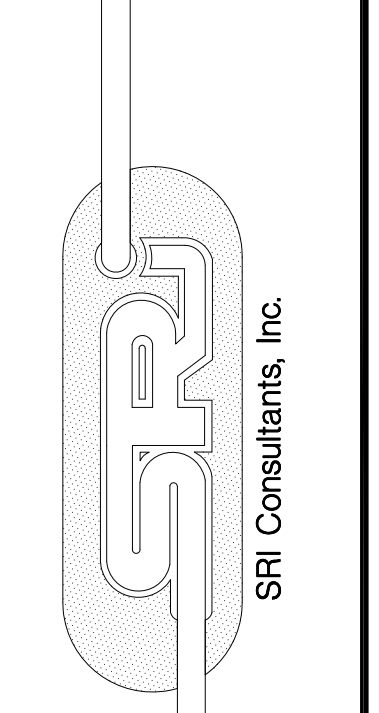

NO.	DESCRIPTION